

Projektiranje stambeno poslovne zgrade P+5 od CLT-a

Spajić, Monika

Master's thesis / Diplomski rad

2024

Degree Grantor / Ustanova koja je dodijelila akademski / stručni stupanj: **University of Zagreb, Faculty of Civil Engineering / Sveučilište u Zagrebu, Građevinski fakultet**

Permanent link / Trajna poveznica: <https://um.nsk.hr/um:nbn:hr:237:729732>

Rights / Prava: [In copyright](#)/[Zaštićeno autorskim pravom.](#)

Download date / Datum preuzimanja: **2025-01-11**

Repository / Repozitorij:

[Repository of the Faculty of Civil Engineering,
University of Zagreb](#)





Sveučilište u Zagrebu

GRAĐEVINSKI FAKULTET

Monika Spajić

**PROJEKTIRANJE STAMBENO POSLOVNE
ZGRADE P+5 OD CLT-A**

DIPLOMSKI RAD

Zagreb, 2024.



Sveučilište u Zagrebu

GRAĐEVINSKI FAKULTET

Monika Spajić

**PROJEKTIRANJE STAMBENO POSLOVNE
ZGRADE P+5 OD CLT-A**

DIPLOMSKI RAD

Mentor: prof. dr. sc. Vlatka Rajčić

Komentor: mag.ing.aedif. Jure Barbalić

Zagreb, 2024.



University of Zagreb

FACULTY OF CIVIL ENGINEERING

Monika Spajić

**DESIGN OF THE RESIDENTIAL - OFFICE
BUILDING FROM CLT**

MASTER THESIS

Supervisor: prof. dr. sc. Vlatka Rajčić

Co-supervisor: mag.ing.aedif. Jure Barbalić

Zagreb, 2024.

ZAHVALE

Da stavim krunu na svoje „đačko doba“ i na ovaj diplomski rad, želim se iskreno zahvaliti svima koji su na bilo koji način bili uz mene na svakom koraku ovog putovanja.

Posebnu zahvalnost upućujem svojim roditeljima i sestrama, koji su mi uvijek bili najveća životna podrška i kritika. Vaša vjera u mene, čak i kad sam sama sumnjala u sebe i svoje sposobnosti, bila je temelj na kojem sam gradila svoj uspjeh. Ovaj rad posvećujem vama, kao zahvalu za sve što ste učinili za mene i omogućili mi da postanem osoba kakva jesam. Sve što jesam i sve što ću ikad biti, vama dugujem!

Ne mogu zaboraviti ni svoju strinu i stričeve, tetke, ujake i ujnu, bake i sve rođake koji su me uvijek podržavali. Iako je nemoguće sve vas imenovati, znajte da cijenim sve što ste učinili za mene.

Hvala svim prijateljima i kolegama koje sam upoznala na fakultetu, koji ste sa mnom učili, radili programe cijele dane i noći i nesebično mi pomagali kad bi negdje zapelo. Za svu podršku, motivaciju i ohrabrenje kad je trebalo. Hvala Elena, Kiara, Andrea, Rina, Ana Marija, Marko, Dora, Petra, Ivane i Domagoj!

Posebnu zahvalnost izražavam ekipi iz tvrtke CroBIM, koja mi je pružila priliku za prvi posao tijekom studija. Iako je naš rad bio kratak, iskustvo koje sam stekla bilo je izuzetno vrijedno. Kao što kaže poznata izreka: „Dadni čovjeku ribu i prehraniti ćeš ga za jedan dan. Nauči ga pecati i prehraniti ćeš ga za čitav život.“ Vi ste mi omogućili da naučim kako „pecati“, i za to sam vam vječno zahvalna. Hvala vam na svakom pitanju, poticaju i prilici da rastem i razvijam se.

Hvala i svim profesorima od kojih sam imala priliku učiti, a posebno mojoj mentorici

prof. dr. sc. Vlatki Rajčić i komentoru mag.ing.aedif. Juri Barbaliću na pomoći prilikom izrade ovog diplomskog rada.

Za kraj ovog poglavlja, želim se zahvaliti Bogu na svim blagoslovima, mudrosti i snazi koju mi je dao tijekom ovog putovanja. Ništa ja ne bih bila bez Njega.

I da, ovo nije kraj, nego tek početak...

SAŽETAK

Ovaj rad se bazira na projektu konstrukcije visoke zgrade katnosti P+5K od križnolameliranog drva i lijepljenog lameliranog drva koja se jednim zidom oslanja na već postojeću zgradu. Kao uvod u projektni zadatak obrađena je teorijska podloga u kojoj su opisani materijali na osnovi drva, križnolamelirano drvo i lijepljeno lamelirano drvo, kroz osvrt na bitne mehaničke karakteristike i teorije proračuna. Konstrukcija je proračunata na sva granična stanja u koja spadaju granično stanje nosivosti (GSN), granično stanje nosivosti u slučaju požara i granično stanje uporabivosti (GSU) s racionalnom iskoristivosti. Konstrukcija je modelirana u softveru DLUBAL RFEM. Lokalni proračun ploča te proračun spojeva, koji u drvenim konstrukcijama imaju bitnu ulogu kod ponašanja konstrukcije pod različitim djelovanjima, je napravljen u softveru Calculatis. Cijeli projekt je usklađen sa skupom europskih normi – Eurokodom te nacionalnim dodatkom Slovenije.

HRN 1990 EN

HRN 1991 EN

HRN 1993 EN

HRN 1995 EN

HRN 1998 EN

NA SLOVENIJE

EN 16351

Ključne riječi: križnolijepljeno lamelirano drvo, lijepljeno lamelirano drvo, projekt konstrukcija, obnovljivi materijali, održivost, zelena gradnja

SUMMARY

This project is based on the design of the construction of a high-rise building of P+5K of cross laminated timber (CLT) and glued laminated timber (GLT), which is supported by one wall on an existing building. As an introduction to the project task, the theoretical basis about timber-based materials (CLT and GLT) was explained through a review of essential mechanical characteristics and calculation theories. The construction is designed for all limit states, which include the limit state of load (GSN), the limit state of load in case of fire and the limit state of use (GSU) with rational usability. The construction was modeled in the DLUBAL RFEM software. The local calculation of panels and walls and the calculation of joints, which play an important role in the behavior of the timber structures under different actions, was made in the Calculatis software. The entire project is harmonized with a set of European norms - the Eurocode and the national supplement of Slovenia.

HRN 1990 EN

HRN 1991 EN

HRN 1993 EN

HRN 1995 EN

HRN 1998 EN

IN SLOVENIA

EN 16351

Key words: cross-glued laminated timber, glued laminated timber, construction project, renewable sources, sustainability , green buildings

SADRŽAJ

ZAHVALE	i
SAŽETAK.....	ii
SUMMARY	iii
SADRŽAJ.....	iv
1. UVOD	1
2. METODE I TEHNIKE RADA	10
3. PROJEKT KONSTRUKCIJE STAMBENE ZGRADE.....	11
3.1. Arhitektonsko idejno rješenje.....	11
3.2. Tehnički opis	13
3.3. Analiza opterećenja	16
3.3.1. Stalno opterećenje.....	16
3.3.2. Uporabno opterećenje	16
3.3.3. Snijeg.....	16
3.3.4. Vjetar	19
3.3.5. Slučaj 1 – vjetar puše na uzdužnu stranu objekta $c_{pi} = + 0,2$	20
3.3.6. Slučaj 2 – vjetar puše na uzdužnu stranu objekta, $c_{pi} = - 0,3$	25
3.3.7. Slučaj 3 – vjetar puše na poprečnu stranu objekta $c_{pi} = +0,2$	27
3.3.8. Slučaj 4 – vjetar puše na poprečnu stranu objekta, $c_{pi} = - 0,3$	31
3.3.9. Potres.....	33
3.4. Globalni statički proračun konstrukcije (P+5).....	36
3.5. Dimenzioniranje – Dlubal RFEM	74
3.5.1.1. Dimenzioniranje elemenata (grede i stupovi - GL32h).....	74
3.5.1.2. Dimenzioniranje CLT zidnih panela ($d=20$ cm i $d=14$ cm).....	85
3.5.1.3. Dimenzioniranje elemenata (S355) – čelični stupovi	93
3.6. Dimenzioniranje CLT panela ($d=22$ cm) – Stora Enso	100
3.6.1. Dimenzioniranje međukatne konstrukcije – kontinuirana ploča preko 2 raspona.....	100
3.6.2. Dimenzioniranje međukatne konstrukcije – konzola	113
3.6.3. Dimenzioniranje krovne ploče	125
3.7. Dimenzioniranje čelične grede (HEA 300) – Stora Enso	138
3.8. Proračun karakterističnih spojeva – Stora Enso	145
3.8.1.1. Detalj A – spoj grede (GL32h) s međukatnom pločom (CLT).....	145
3.8.1.2. Detalj B – spoj međukatne konstrukcije (CLT) sa zidnim panelima (CLT).....	149
3.8.1.3. Detalj C – spoj zidnih panela (CLT) vertikalno	153
3.8.1.4. Detalj D – spoj panela međukatne konstrukcije (CLT) međusobno u ravnini	155

3.8.1.5. Detalj E – spoj zidnih panela (CLT) s AB zidom	159
3.8.1.6. Detalj F – spoj međukatne konstrukcije (CLT) na čeličnu gredu.....	162
4. ZAKLJUČAK	166
POPIS LITERATURE.....	167
POPIS SLIKA	168
PRILOZI	169

1. UVOD

Jedno od najstarijih i najranije korištenih konstrukcijskih materijala je drvo jer je bilo dostupno i lako za upotrebu . Krajem 19. i početkom 20.-tog stoljeća dolazi do snažnog napretka znanosti i tehnologije te razvoja novih materijala: čelika, betona i opeke. Industrijska revolucija, poboljšanje gospodarske moći društva te loša iskustva s dotadašnjim velikim požarima dovela su do zamjene tradicionalne drvene konstrukcije (konstrukcija od balvana ili greda ili rešetkastih nosača) novim materijalima, barem u Europi.

Ti, danas najčešće korišteni materijali, zbog svoje ekonomičnosti i potrebe za gradnjom visokih građevina, doživjeli su nagli procvat u prošlom stoljeću te je drvo kao građevinski materijal svedeno na tržišni udio od svega nekoiko postotaka i prvenstveno se koristilo u laganim drvenim konstrukcijama (rešetke ili okviri), za podizanje obiteljskih i stambenih objekata, za atraktivne konstrukcije.

Međutim, u posljednjih 30-ak godina drvo je preuzelo tržišne udjele od čvrstih građevinskih materijala na bazi minerala, posebice u područjima stambenih zgrada, poslovnih zgrada, škola i dječjih vrtića, ali i u drugim područjima gradnje. Očigledno, ovo ponovno povećanje tržišnog udjela također je posljedica renesanse drva u gradovima u kojima se stoljećima bojalo ovog prirodnog i održivog građevinskog materijala zbog njegove zapaljivosti.

U posljednje vrijeme velik je interes javnosti te se više obraća pozornost na drastične klimatske promjene koje na dugoročno utječu na kvalitetu života ljudi.

Za upotrebu drva kao građevinskog materijala potrebna je sječa šuma, ali korištenje umjetnih materijala (beton; čelik) ima posljedicu ispuštanje stakleničkih plinova, tj. onečišćenje okoliša. Drvo ima prednost zbog svoje održivosti, šume se obnavljaju i na to možemo utjecati. Veći problem je kako očistiti atmosferu od stakleničkih plinova čija emisija se povećava konstantno?

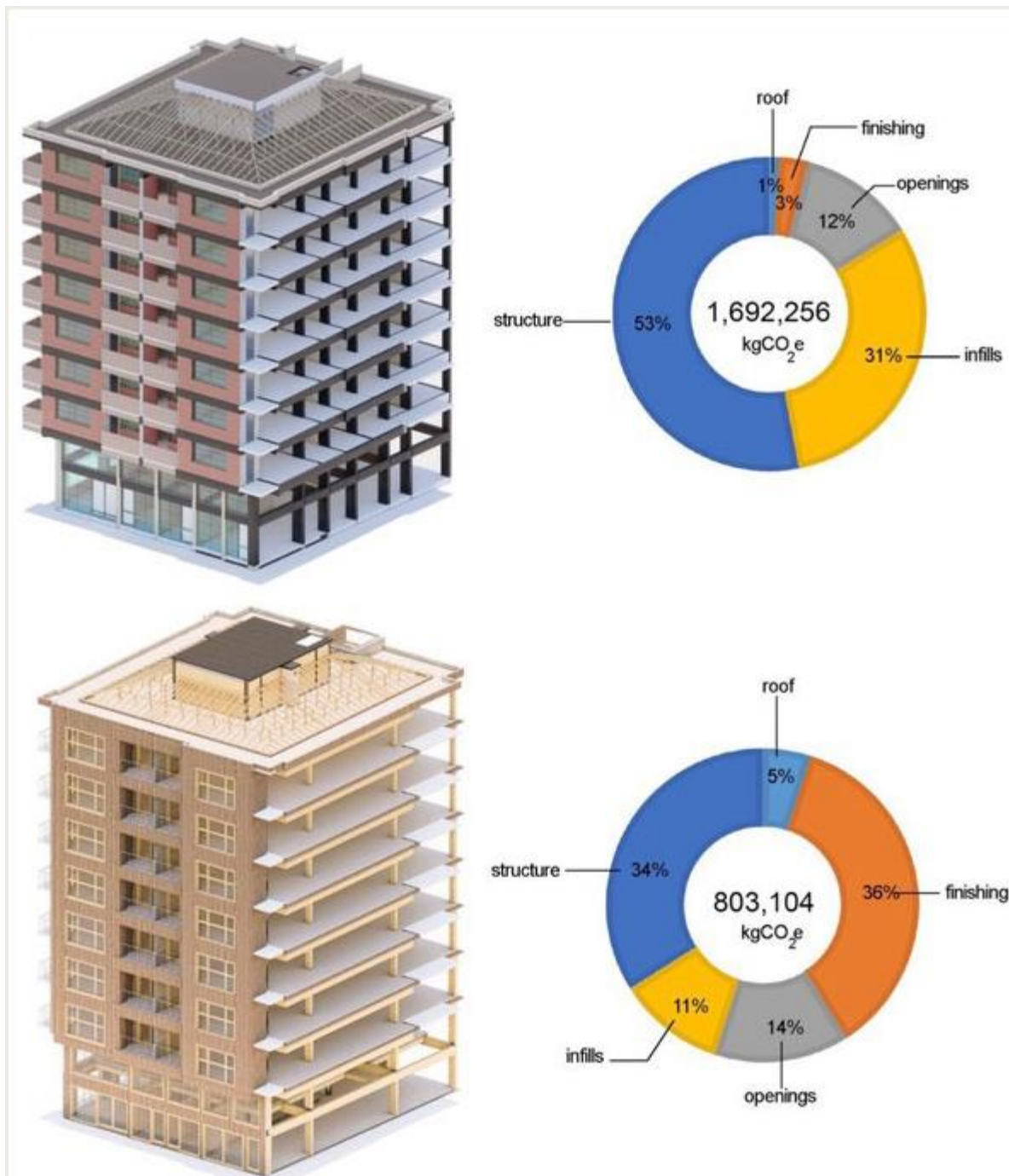

Slika 1.1. Oslobađanje CO₂ – konvencionalna gradnja / drvena gradnja

Ekološke prednosti CLT značajno mu daju prednost naspram ostalih materijala. Analizom emisije ugljika (tijekom proizvodnje i upotrebe drva, čelika i betona) drvo se pokazalo kao najblaži utjecatelj. U nastavku su prikazani okvirni utjecaji pojedinog materijala.

- „Beton:

Proizvodnja jedne tone cementa, ključnog sastojka betona, emitira otprilike jednu tonu CO₂ u atmosferu. Globalno, industrija cementa odgovorna je za 7% svih emisija

CO₂. Proizvodnja betona odgovorna je za otprilike 8% svjetskih emisija ugljičnog dioksida.

- Čelik:

Čelična industrija jedan je od najvećih industrijskih izvora emisija CO₂. Za svaku tonu proizvedenog čelika emitira se otprilike dvije tone CO₂. Proizvodnja čelika čini otprilike 7-9% ukupnih svjetskih emisija ugljičnog dioksida.

- Drvo

Drvo je neutralno prema ugljiku, budući da stabla apsorbiraju CO₂ tijekom svog rasta. Ukupni ugljični otisak u CLT-u znatno je manji od onog u betonu ili čeliku. CLT ima potencijal smanjiti emisije CO₂ u građevinarstvu za značajnu mjeru.“ [7]

Prednosti gradnje drvetom su sljedeće :

- Manja težina konstrukcije što rezultira manjim opterećenjem i jednostavnijim zahtjevima za temeljenje
- Brža izgradnja
- Manja ogranočenja u arhitektonskom oblikovanju
- Smanjeni troškovi prijevoza – transport samo gotovih elemenata iz tvornice do gradilišta
- Smanjeno osobađanje CO₂
- Odlična izolacijska svojstva
- Održiva gradnja – obnovljivi materijal izgradnje

Povratak na gradnju drvom može se većim dijelom pripisati izumu novih materijala – križnolijepljenog lameliranog drva i lijepljenog lameliranog drva.

CLT nazivaju beton budućnosti jer ograničenja u izgradnji po pitanju CLT-a ili lameliranog lijepljenog drveta ne postoji. Može se napraviti sve ono što se može isprojektirati.

Križnolijepljeno lamelirano drvo (engl. cross laminated timber - CLT) predstavlja proizvod od strukturalnog kompozitnog drva koji je dobiven specifičnim slaganjem i lijepljenjem lamela jedne za drugu. Iako CLT svoje korijene ima u Europi, zbog odličnih seizmičkih i požarnih svojstava, vrlo brzo se počeo primijenjivati i van granica Europe. Tako su npr. zemlje poput SAD, Kanade, Kine i Japana počele koristiti CLT proizvode. CLT i lijepljeno lamelirano drvo (LLD) najčešće dolaze u kombinaciji u konstrukcijskom sustavu građevina i to obično su pločasti elementi (zidovi i stropne ploče) od CLT-a, a linijski elementi (grede i stupovi) od LLD-a .

„CLT se sastoji od više slojeva dimenzioniranih dasaka od drva, obično tri do sedam slojeva, koji su sustavno orijentirani okomito jedan na drugog. Slojevi se lijepe zajedno ekološki prihvatljivim ljepljivima, rezultirajući snažnom, inženjerskom drvenom pločom s izvanrednim mehaničkim svojstvima. Mjesto uporabe panela ovisi o načinu proizvodnje, orijentacije lamela i lijepljenja slojeva. Paneli koji se izrađuju na način da im je završni sloj okomit na proizvodnu duljinu najčešće se koriste u izradi zidova. Dok se paneli kojima je završni sloj paralelan na proizvodnu duljinu najčešće koriste za ploče i krovove.“ [7]

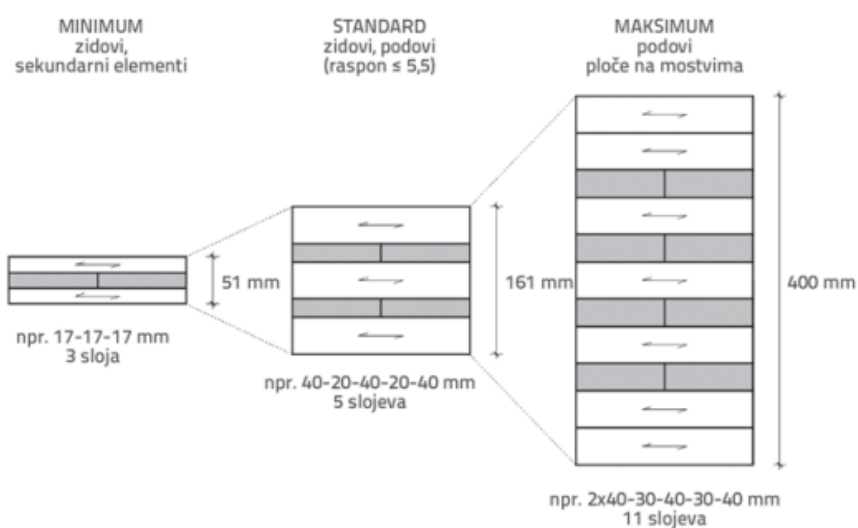

Slika 1.2. Slaganje lamela u CLT panelu ovisno o vrsti elementa za koji je korišten

Debljina pojedine lamele može biti od 16 do 51 mm, a širine se kreću u rasponu od 60 do 240 mm. Uobičajene dimenzije CLT panela su duljina do 18 m (ili čak 30 m), širina do 3,0 m (ili čak 4,8 m) i debljina rijetko veća od 300-400 mm.

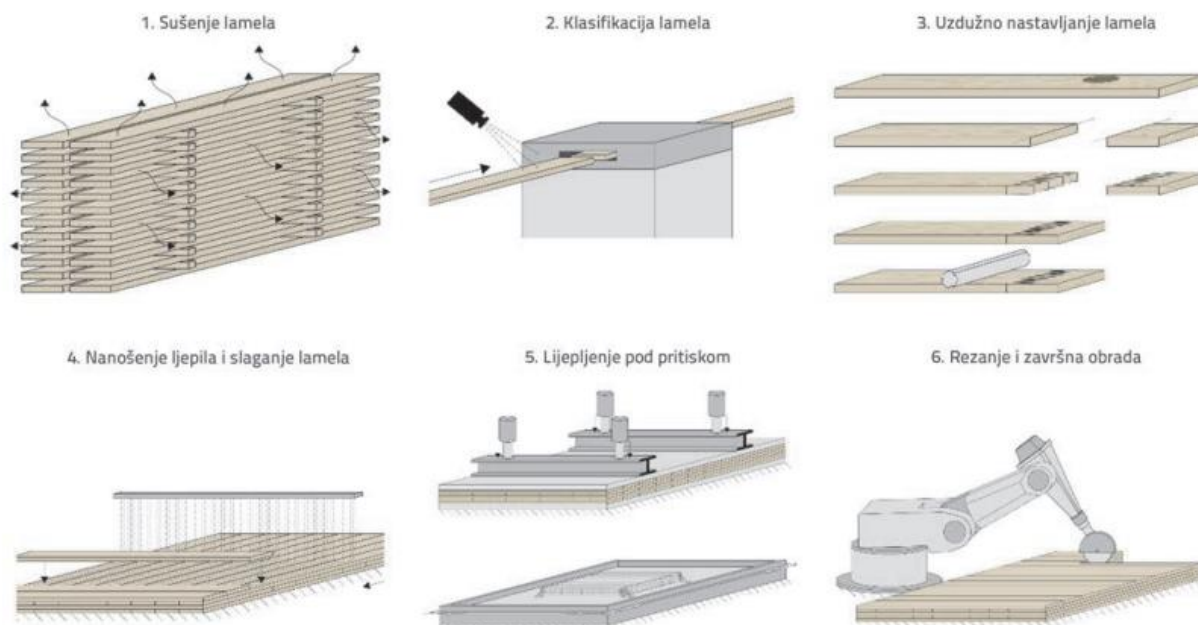

Slika 1.3. Postupak proizvodnje CLT elementa

CLT se uglavnom proizvodi od mekog drva klase C24. Sama proizvodnja započinje sušenjem lamela i klasifikacijom materijala. Vлага u materijalu je ograničena na 9% do 15%. Time sprječavamo pojavu pukotina. Slaganje i lijepljenje lamela jednog panela traje otprilike 15 do 60 minuta. Ljepila koja se koriste su poliuretanska ljepila, emulzijska polimerna izocijantna ljepila ili melanim-urea-formaldehid. Postupak lijepljenja, količina nanesenog ljepila, sadržaj vlage u prijanjanju i drugi, temelje se na iskustvu s lijepljenim pločama. U međuvremenu su neki proizvođači ljepila prilagodili svoje propise za CLT. Parametri kao što su tlak lijepljenja i primijenjena količina su od posebne važnosti. Pritisci lijepljenja od 0,10–1,00 N/mm² pa čak i viši mogu se osigurati pomoću hidrauličke opreme, dok vakuumske preše i prešanje vijcima, spajalicama ili čavlima postižu pritiske lijepljenja u rasponu od 0,05–0,10 odnosno 0,01–0,20 N/mm². Potreban pritisak lijepljenja bočne strane može se definirati kao funkcija sustava ljepila, vrste drva, geometrije ljepila u pogledu hrapavosti i ravnosti površine i dopuštenih tolerancija u debljini, sustav nanošenja ljepila i naneseu količinu ljepila. Sama naneseu količina ovisi o hrapavosti površine ljepila, a time i o vrsti drva. Kad je ljepilo postiglo željeno očvršćavanje, geometrija panela se korigira te se oni režu na određene dimenzije. Za rezanje se koriste CNC strojevi koji imaju jako veliku preciznost. Nakon rezanja još je potrebna završna obrada, ovisno o mjestu ugradnje panela.

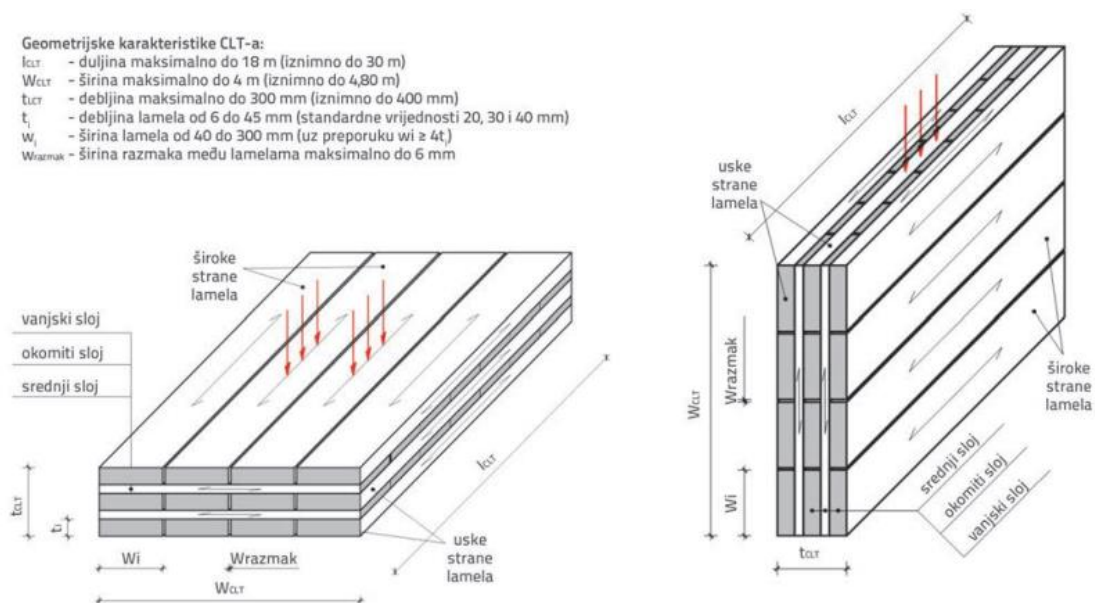

Slika 1.4. Geometrijske karakteristike CLT elementa za djelovanje okomito na ravninu elementa (lijevo) i djelovanje u ravnini elementa (desno)

Najviša zgrada na svijetu izgrađena od materijala na osnovi drva je visoka 85 metara, a to je 18-etažna zgrada Mjøstårnet u Norveškoj. Struktura i fasada zgrade izrađeni su od drveta, dok su se na sedam najviših etaža koristile betonske podne ploče kako bi se povećala njihova težina i usporilo njihanje zgrade pri horizontalnom djelovanju. Zgrada je usidrena u zemlju s podzemnim stupovima do dubine od 50 metara.

Primarni nosivi sustav (stubovi, grede i dijagonale) je od LLD nosača, nadopunjenih sa križno-uslojenim (CLT) pločama (za otvore za liftove i balkone, ploče), LVL elementima (za uređenje enterijera) i drugim proizvodima od drveta.



Slika 1.5. Mjøstårnet u Norveškoj – vanjski dizajn i stepenište

Hoho toranj u Austriji je još jedan ogledni primjer suvremenih drvenih konstrukcija. Sa svojih 24 kata i visinom od 84 metra je najviši hibridni drveni neboder na svijetu. Hoho toranj je hibridna konstrukcija od drva i betona. Nosivi elementi kao što su zidovi, stupovi i stropovi izrađeni su od drveta.



Slika 1.6. Hoho toranj u Beču, Austrija

Gradnja visokih zgrada od drveta nije se razmatrala godinama zbog usporedbi slabijih mehaničkih karakteristika drveta s armiranom betonom i čelikom. Problem stabilizacije drvene konstrukcije na horizontalna djelovanja (snijeg, vjetar) je znatno veći nego kod armiranobetonske ili čelične konstrukcije jer je manja krutost materijala, tj. manji je modul elastičnosti drva u odnosu na čelik i beton. Zbog navedenog, horizontalna djelovanja na drvenu konstrukciju mogu uzrokovati značajnije deformacije, ali se one mogu i ograničiti dovoljno krutim sustavom. Modul elastičnosti drva okomito na smjer pružanja vlakana je izrazito mali te je izvođenje krutih spojeva u drvenim konstrukcijama daleko izazovnije nego u armiranobetonskim i čeličnim.

Osim izgradnje novih konstrukcija na bazi drva kao konstrukcijskog materijala, u posljednje vrijeme se kao najoptimalnije rješenje vertikalne nadogradnje na postojeće zgrade pokazala upravo gradnja CLT-om i LLD-om. Svojom značajno manjom težinom i načinom (suha gradnja) i brzinom izvedbe ima prednost u usporedbi s tradiciionalnom AB gradnjom jer se može nadograditi veći broj etaža bez velikog ojačavanja postojeće konstrukcije, gdje AB gradnja brzo dostiže limit. Primjer toga je vertikalna drvena nadogradnja hotela od 10 katova na vrhu već postojećeg komercijalnog centra u Melbourne-u u Australiji.



Slika 1.7. Southbank building – Melbourne, Australija

Na šesterokatnoj poslovnoj zgradi podignutoj 1989. bilo je potrebno povećati kapacitet dodavanjem deset dodatnih katova koristeći CLT, što daje 13 000 četvornih metara dodatnog prostora. Visina proširenja je bila ograničena postojećim kapacitetom pilona, isključujući mogućnost ugradnje novih pilona unutar konstrukcije.

Nakon razmatranja različitih opcija uključujući betonske ploče i kompozitne ploče, CLT je odabran zbog svoje sposobnosti da primi deset katova bez nadmašivanja kapaciteta pilota, za razliku od betonskih ploča koje su izvedivo mogle podržati samo proširenje od šest katova.

Postojeći stupovi zgrade su ojačani, a središnji zidovi ojačani da izdrže dodatno opterećenje, uključujući CLT zidove između hotelskih soba. S obzirom na povećana bočna opterećenja, uvedene su dvije nove čelične jezgre, koje uključuju postojeće betonske zidove u sustav stabilnosti i učvršćuju postojeće jezgre. Kako bi se održao panoramski pogled, čelične grede i stupovi dizajnirani su da podupru CLT podne ploče i prilagode veći razmak između zidova oko zakrivljenih dijelova zgrade. Korištenjem predgotovljene lamelirane drvene građe i prihvaćanjem načela kružnog gospodarstva za prenamjenu postojeće zgrade, uštedeno je vrijeme i novac, a istovremeno smanjen utjecaj na okoliš povezan s rušenjem i rekonstrukcijom.

U zadnjih desetak godina u svijetu je izgrađeno na desetke višeetažnih drvenih zgrada. U njih ubrajamo i zgrade s hibridnim sustavima beton-drvo i čelik-drvo. U takvim sustavima drvo tvori okvire i međukatne ploče, dok su od betona i čelika uglavnom jezgre dizala i stubišta. U potpuno drvenim sustavima nerijetko su potrebni manji ili veći spregovi po vanjskom obodu zgrade jer sama jezgra i posmični zidovi od CLT-a ne omogućavaju dostatnu krutost na horizontalna djelovanja.

Analizom različitih statističkih podataka o emisijama ugljičnih spojeva, možemo vidjeti CLT predstavlja potencijal održivosti, smanjujući utjecaj oslobađanja ugljika u građevinskom sektoru.

Povrh toga, CLT također pruža strukturalno čvrste i energetske učinkovite konstrukcije, te održivu i ekološki odgovornu budućnost za generacije koje dolaze. Prihvatanje tehnologije CLT-a nije samo tehnološki napredak – to je korak prema zelenijem i otpornijem planetu.

2. METODE I TEHNIKE RADA

Model konstrukcije i dimenzioniranje je napravljeno u softveru Dlubal RFEM 6 uz pomoćni online modul za računanje CLT i LLD elemenata Calculatis - Stora Enso u kojemu je napravljen proračun stropnih ploča, čelične grede na koju se oslanja međukatna konstrukcija te proračun karakterističnih spojeva. Dan je kompletan dokaz nosivosti i uporabivosti prema europskim normama za sve elemente od CLT-a i LLD-a, te za čelične stupove na koje se oslanjaju balkoni s jedne strane konstrukcije. Proračun spojeva je napravljen za sve karakteristične spojeve. Proračun armirano-betonskih zidova i temeljne ploče nije prikazan u ovom diplomskom radu jer se bazira prvenstveno na proračunu materijala na bazi drva – CLT-u i LLD-u.

3. PROJEKT KONSTRUKCIJE STAMBENE ZGRADE

3.1. Arhitektonsko idejno rješenje

Ovaj diplomski rad napravljen je prema podlozi projekta za natjecanje *proHolz Student Trophy 24* u kojem su surađivali studenti Arhitektonskog i Građevinskog fakulteta u Zagrebu. Studentsko natjecanje je bilo fokusirano na potencijal za širenje i konsolidaciju unutar grada koristeći drvo kao građevinski materijal.

Od 3 zadatka, tj. 3 lokacije u Beču (1. Proširenje škole – horizontalna nadogradnja, 2. Dodatak uz rub bloka – vertikalna nadogradnja, 3. Vertikalna nadogradnja postojeće zgrade) odabrali smo 2. lokaciju - projekt nadogradnje uz rub postojeće zgrade.

Dodatak rubu bloka ima za cilj zatvoriti perimetar bloka, nastavljajući tradicionalnu urbanu mrežu i pružajući zajednici dodatne pogodnosti s uličnog pristupa kao što su radni prostori, mala poduzeća, kafići, multifunkcionalni prostori za iznajmljivanje, sobe za sastanke, itd., dok djelomično zatvaranje unutarnjeg prostora u sigurnu zelenu površinu osigurava prostor za društvenu interakciju, a u isto vrijeme djelomično rješava problem smanjenja buke od prometa. Odgovornosti povezane s dizajnom koncentrirane su na suočavanje s postojećim strukturama jer se konstrukcija trebala osloniti jednim zidom na postojeću zgradu.



Slika 3.1. Pogled na konstrukciju - sjeverozapad



Slika 3.2. Pogled na konstrukciju – jug



Slika 3.3. Detalj vanjskih prolaza između stanova na južnoj i istaka zidova na sjevernoj strani



3.2. Tehnički opis

Ovaj projekt konstrukcije obrađuje projekt drvene nosive konstrukcije, tipa masivna gradnja, stambene zgrade od lijepljenog lameliranog drva (LLD) i križno lameliranog drva (CLT) u Zagrebu.

Stambena zgrada se sastoji od 6 etaža: podrum, prizemlje i 5 katova (P+5). Temeljna ploča, armiranobetonska konstrukcija podruma, jezgre dizala i stubišta te nekoliko zidova prizemlja koji su izvedeni kao AB elementi u nastavku će biti uzeti kao pretpostavljene dimenzije te detaljan proračun ije prikazan u ovom radu. Karakteristike AB konstrukcije ne utječu direktno na proračun drvene konstrukcije.

Tlocrt konstrukcije je U oblika sa nepravilno raspoređenim zidovima. Kvadratne tlocrtne dimenzije su 75,35x27,50 m, sa dvorišnim isječkom dimenzija 48x15 m. Ukupna visina građevine je 19,08 m. Posljedna etaža je uža od ostalih te je terasa ispred stanova prohodna. Krovna ploča posljednje etaže je neprohodna.

Temelji su pretpostavljeni kao temeljne trake 100x100 cm ispod zidova. AB ploča preko njih je debljine 50 cm.

Temeljno tlo je kruta glina i spada u tip C temeljnog tla. Podrumska etaža, te pojedini zidni elementi prizemlja, cijeli zid koji se oslanja na postojeću zgradu te jezgre stubišta i dizala izvedene su od armiranog betona (dalje AB) klase C35/40, dok su svi ostali elementi izvedeni od LLD-a i CLT-a. Kvaliteta CLT-a je C24, dok je kvaliteta LLD-a GL32h.

AB zidovi podruma su debljine 30 cm i stupova dimenzija 30x30 cm na koje su povezane AB grede dimenzija $b/h=30/40$ cm. Podrumska etaža je u potpunosti ukopana. Strop podrumske etaže izveden je kao AB ploča debljine 30 cm. Visina podrumske etaže je 3,80 m, a visina prizemlja je 3,48 m. Visina svih etaža iznad je 2,88 m. Etaže od 1. do 5. kata izvedene su od CLT zidova i stropnih poča te LLD greda različitih dimenzija.

CLT paneli koji će se koristiti u izvedbi su od proizvođača *Stora Enso*. Klasa drveta korištena za lamele u panelima je C24. Grede su od LLD-a su različitih dimenzija te su svi prikazani u proračunu i u nacrtima. Grede i stupovi proizvedeni su od klase drva GL32h. Na krovni panel, nakon izolacijskih materijala, naknadno dolazi šljunak kao pokrov. Paneli i grede spajaju se modernim spojnim sredstvima proizvođača Rothoblaas. Stubište i jezgra dizala je planirana u izvedbi od armiranog betona.

Konstrukcija je projektirana tako da zadovolji granična stanja nosivosti i uporabivosti te požarnu otpornost i vibracije. U statički proračun uzeta su sva opterećenja koja propisuje Eurocode s pripadajućim nacionalnim dodacima. Provedena je i dinamička (potresna) analiza

te je dokazana otpornost konstrukcije na vršno ubrzanje tla vjerojatnosti premašaja od 10% u 50 godina (povratni period od 475 godina).

Prilikom proračuna su primijenjene sljedeće norme iz pojedinih Eurokodova:

HRN EN 1990, HRN EN 1991, HRN EN 1993, HRN EN 1995, HRN EN 1998 i EN 16351 te pripadajući nacionalni dodaci za RH i Sloveniju. Za potrebe cjelokupnog proračuna korišteni su programi Dlubal RFEM 6 s pripadajućim modulima te *Calculatis – Stora Enso*, a izvedbena dokumentacija je napravljena u AutoCAD-u. Izometrijski prikaz modela prikazan je na slikama 3.4. i 3.5.

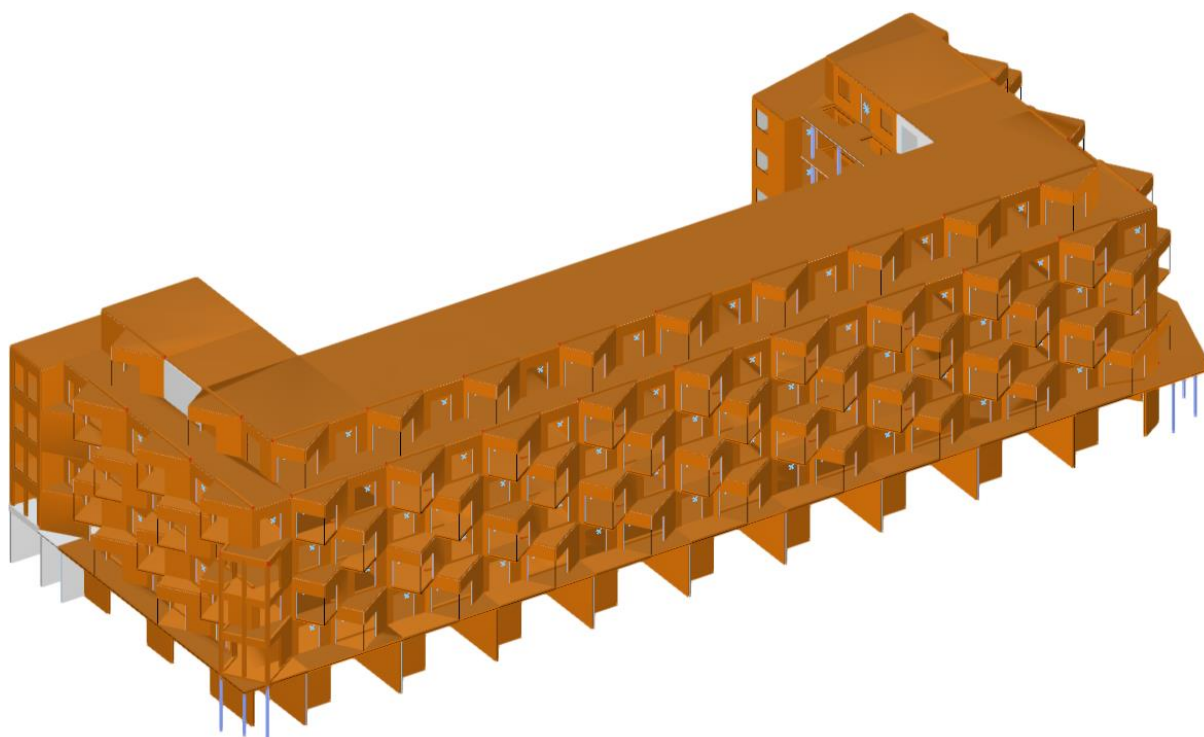

Slika 3.4. Prikaz modela – Dlubal RFEM

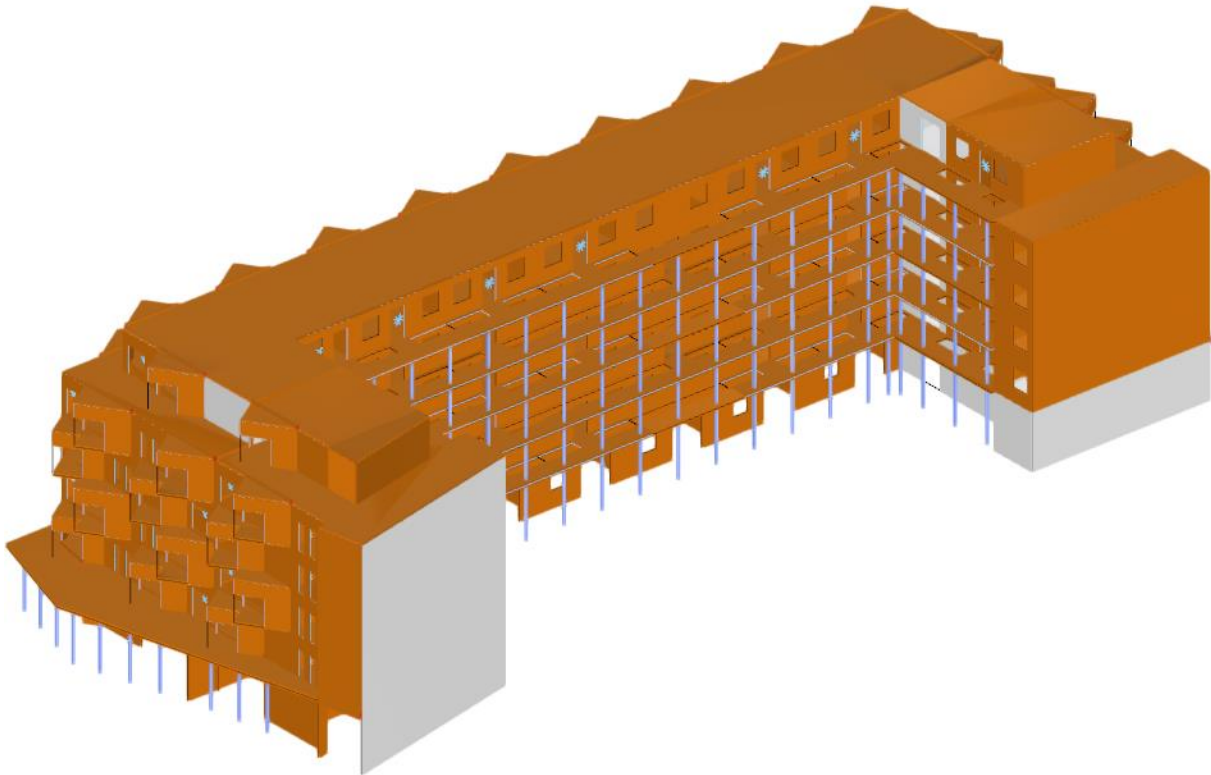

Slika 3.5. Prikaz modela – Dlubal RFEM

3.3. Analiza opterećenja

3.3.1. Stalno opterećenje

<i>Strop 1. - 5. kata</i>	<i>kN/m²</i>
Vlastita težina svih elemenata Dodatno stalno	Dluba! RFEM 1,50
$\Sigma g_{st} = 1,50 \text{ kN/m}^2$	

3.3.2. Uporabno opterećenje

Karakteristične vrijednosti opterećenja iz HRN EN 1991-1-1 i dodatka HRN EN 1991-1-1/NA

Uporabno opterećenje etaža: $q = 2 \text{ kN/m}^2$

Uporabno opterećenje etaža: $q = 4 \text{ kN/m}^2$

Uporabno opterećenje na krovu (neprohodan): $q = 0,6 \text{ kN/m}^2$

Uporabno opterećenje stubišta: 3 kN/m^2

NAPOMENA: Opterećenje stubišta se zadaje kao linijsko opterećenje duž otvora na koji se oslanja stubište te ono iznosi 7,50 kN/m'.

3.3.3. Snijeg

Opterećenja snijegom određena prema HRN EN 1991-1-3 te pripadnom nacionalnom dodatku HRN EN 1991-1-3/NA.

Opterećenje snijegom na krovne površine:

$$s = \mu_i \cdot C_e \cdot C_t \cdot s_k$$

s_k – karakteristična vrijednost opterećenja snijegom na tlo (kN/m^2)

μ_i – koeficijent oblika opterećenja snijegom (α – nagib krova)

C_e – koeficijent izloženosti

C_t - toplinski koeficijent

$C_e = 1$ (preporučena vrijednost)

$C_t = 1$ (preporučena vrijednost)

$\mu_i = 0,8$ ($0^\circ < \alpha < 30^\circ$)

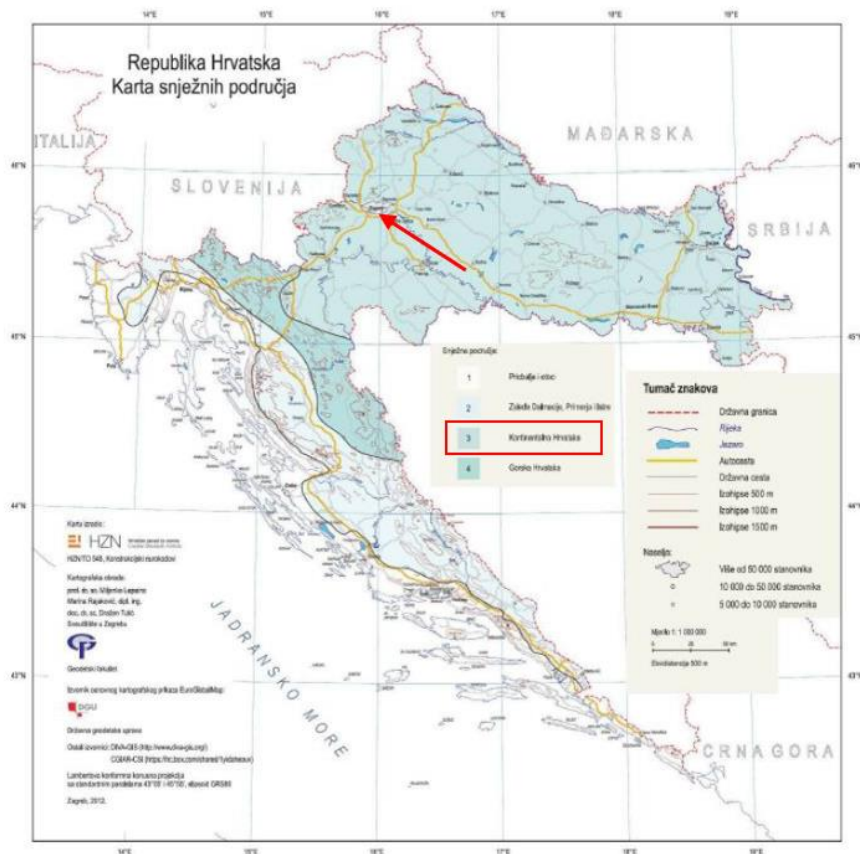

Slika 3.3.1. Karta snježnih područja

Nadmorska visina do [m]	1. područje – priobalje i otoci [kN/m ²]	2. područje – zaleđe Dalmacije, Primorja i Istre [kN/m ²]	3. područje – kontinentalna Hrvatska [kN/m ²]	4. područje – gorska Hrvatska [kN/m ²]
100	0,50	0,75	1,00	1,25
200	0,50	0,75	1,25	1,50
300	0,50	0,75	1,50	1,75
400	0,50	1,00	1,75	2,00
500	0,50	1,25	2,00	2,50
600	0,50	1,50	2,25	3,00
700	0,50	2,00	2,50	3,50
800	0,50	2,50	2,75	4,00
900	1,00	3,00	3,00	4,50
1 000	2,00	4,00	3,50	5,00
1 100	3,00	5,00	4,00	5,50
1 200	4,00	6,00	4,50	6,00
1 300	5,00	7,00		7,00
1 400	6,00	8,00		8,00
1 500		9,00		9,00
1 600		10,00		10,00
1 700		11,00		11,00
1 800		12,00		

Slika 3.3.2. Karakteristična opterećenja snijegom za snježna područja i pripadajuće nadmorske visine

$$s_k = 1,25 \text{ kN/m}^2$$

$$s = \mu_i \cdot C_e \cdot C_t \cdot s_k = 0,8 \cdot 1 \cdot 1 \cdot 1,25 = 1,00 \text{ kN/m}^2$$

Koeficijent izloženosti i toplinski koeficijent uzeti prema usvojenim preporukama u nacionalnom dodatku (vrijednost 1,0). Koeficijentom izloženosti može se smanjiti opterećenje snijegom zbog učinka jakog vjetra dok se toplinskim koeficijentom uzima u obzir gubitak topline preko krovne plohe. Koeficijent oblika krova ima minimalnu vrijednost (0,8) s obzirom da je krov ravan. Karakteristično opterećenje snijegom djeluje vertikalno na horizontalne projekcije površina krova. Karakteristično opterećenje snijegom na tlo očitano je preko tablice karakterističnih opterećenja snijegom za RH (Slika 4.2.8.). Zona i nadmorska visina potrebni za tablicu očitani su sa slike 4.2.7. Opterećenje snijegom nanoseno je na krovnu plohu, otvorenu terasu zadnje etaže i balkon zadnje etaže.

3.3.4. Vjetar

Osnovna brzina vjetra: $v_b = c_{dir} \cdot c_{season} \cdot v_{b,0}$, gdje je:

c_{dir} koeficijent smjera vjetra, $c_{dir} = 1$

c_{season} koeficijent godišnjeg doba, $c_{season} = 1$

$v_{b,0}$ temeljna vrijednost osnovne brzine vjetra, određuje se iz karte vjetrova

$$v_{b,0} = 25 \text{ m/s}$$

$$v_b = c_{dir} \cdot c_{season} \cdot v_{b,0} = 1,0 \cdot 1,0 \cdot 25,0 = 25 \text{ m/s}$$

Tlak pri osnovnoj brzini vjetra:

$$q_b = \frac{1}{2} \cdot \rho \cdot v_b^2 \text{ [N/m}^2\text{]}$$

ρ ... gustoća zraka, $\rho = 1,25 \text{ kg/m}^3$

$$q_b = 0,5 \cdot 1,25 \cdot 25^2 = 390,625 \text{ N/m}^2$$

$$q_b = 0,391 \text{ kN/m}^2$$

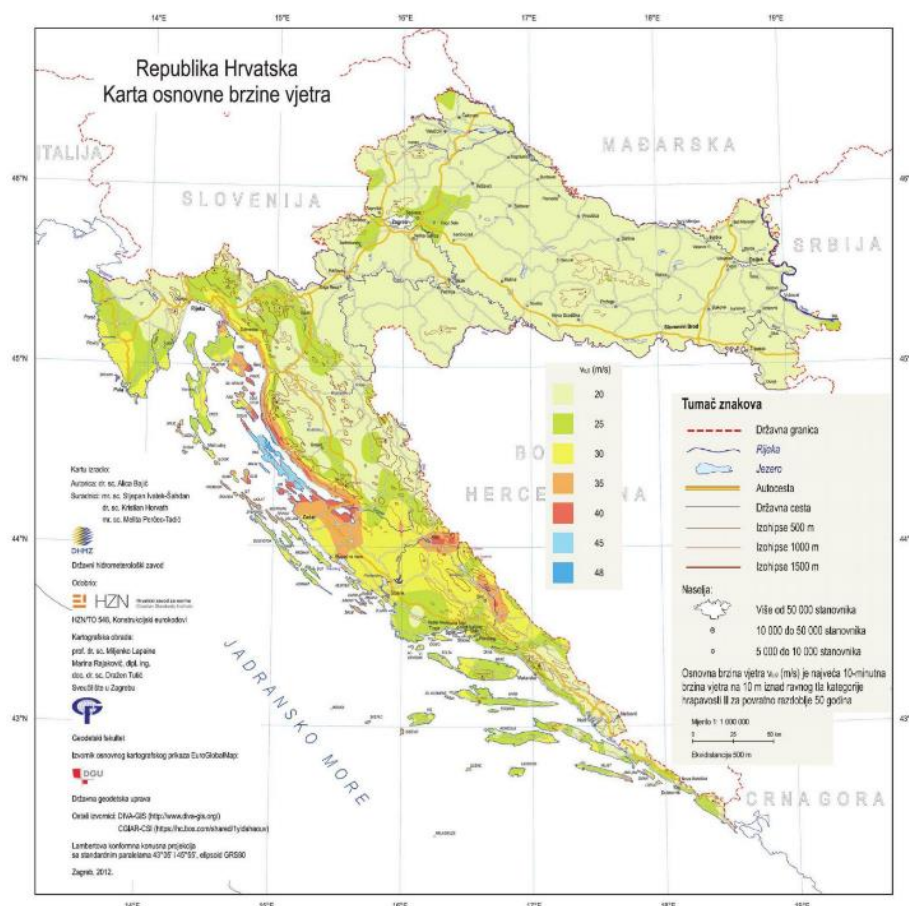

Slika 3.3.3. Karta osnovne brzine vjetra

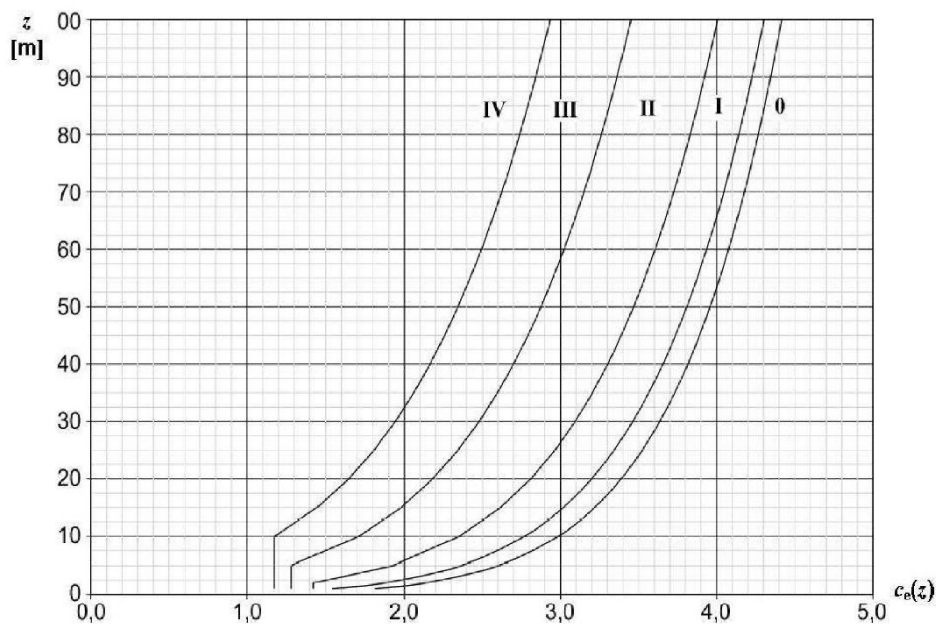

Slika 3.3.4. Koeficijent izloženosti

3.3.5. Slučaj 1 – vjetar puše na uzdužnu stranu objekta $c_{pi} = + 0,2$

Vanjski tlak

Vanjski tlak na vertikalne stijene

Referentna visina:

$$z_e = f_c \left(\frac{h}{b} \right)$$

gdje je:

$$h = 19,08 \text{ m}$$

$$b = 75,25 \text{ m (širina površine na koju puše vjetar)}$$

$$h \leq b \rightarrow z_e = h = 19,08 \text{ m}$$

Koeficijent tlaka na vertikalne stijene

$$e = \min(b; 2h) = \min(75,25; 38,16) = 38,16 \text{ m}$$

$$d = 27,35 \text{ m} \rightarrow e > d$$

$$h / d = 19,08 / 27,35 = 0,675$$

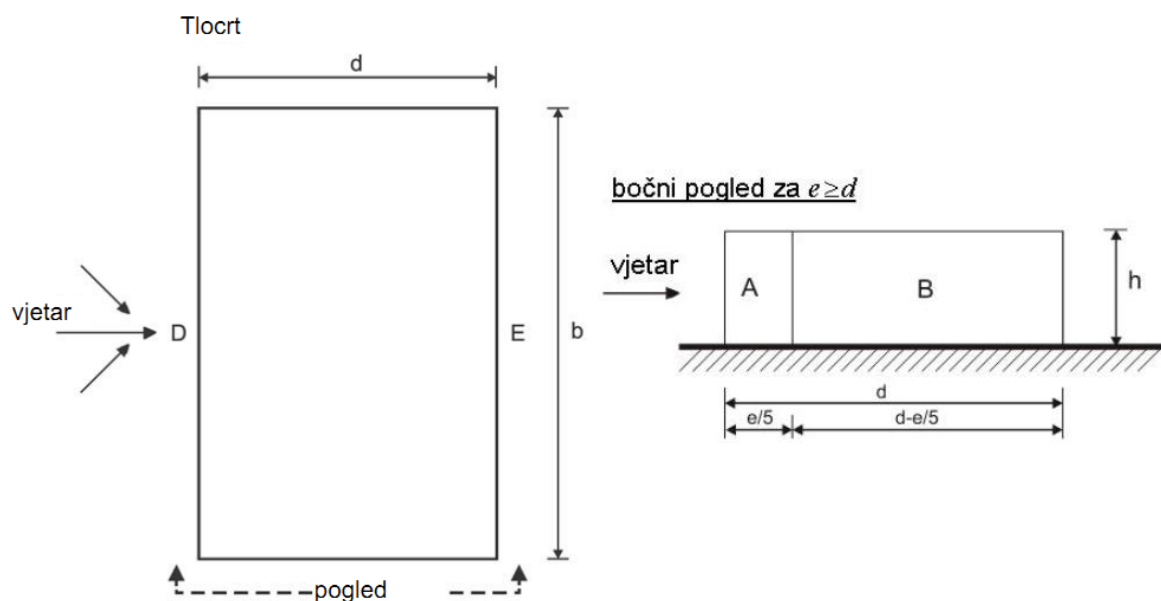

Slika 3.3.5. Koeficijenti vanjskog tlaka za vertikalne zidove građevina pravokutnog tlocrta

$$\text{Površina (A)} = (e/5) \cdot h = (38,16/5) \cdot 19,08 = 136,16 \text{ m}^2 > 10 \text{ m}^2$$

$$\rightarrow c_{pe} = c_{pe,10} = -1,2$$

$$\text{Površina (B)} = (d-e/5) \cdot h = (27,35 - 38,16/5) \cdot 19,08 = 368,45 \text{ m}^2 > 10 \text{ m}^2$$

$$\rightarrow c_{pe} = c_{pe,10} = -0,8$$

$$\text{Površina (D)} = b \cdot h = 27,35 \cdot 19,08 = 504,61 \text{ m}^2$$

$$\rightarrow c_{pe} = c_{pe,10} = +0,8$$

$$\text{Površina (E)} = b \cdot h = 27,35 \cdot 19,08 = 504,61 \text{ m}^2$$

$$\rightarrow c_{pe} = c_{pe,10} = -0,5$$

Koeficijent izloženosti

Teren IV kategorije – područja s najmanje 15% površine pokrivena građevinama čija prosječna visina premašuje 15 m

$$c_e(19,08) = 1,5$$

$$q_p(z_e) = c_e(z) \cdot q_b = 1,5 \cdot 0,391 = 0,587 \text{ kN/m}^2$$

Djelovanje vjetra na vertikalne površine

$$w_e = q_b \cdot c_e(z) \cdot c_{pe}$$

$$w_e^A = 0,587 \cdot (-1,2) = -0,704 \text{ kN/m}^2$$

$$w_e^B = 0,587 \cdot (-0,8) = -0,469 \text{ kN/m}^2$$

$$w_e^D = 0,587 \cdot (+0,8) = +0,469 \text{ kN/m}^2$$

$$w_e^E = 0,587 \cdot (-0,5) = -0,293 \text{ kN/m}^2$$

Vanjski tlak na ravni krov $-5^\circ < \alpha < 5^\circ$

Referentna visina:

$$z_e = f_c \left(\frac{h}{b} \right)$$

gdje je:

$$h = 19,08 \text{ m}$$

$$b = 75,25 \text{ m (širina površine na koju puše vjetar)}$$

$$h \leq b \rightarrow z_e = h = 19,08 \text{ m}$$

Koeficijent tlaka na vertikalne stijene

$$e = \min(b; 2h) = \min(75,25; 38,16) = 38,16 \text{ m}$$

$$d = 27,35 \text{ m} \rightarrow e > d$$

$$h/d = 19,08 / 27,35 = 0,675$$

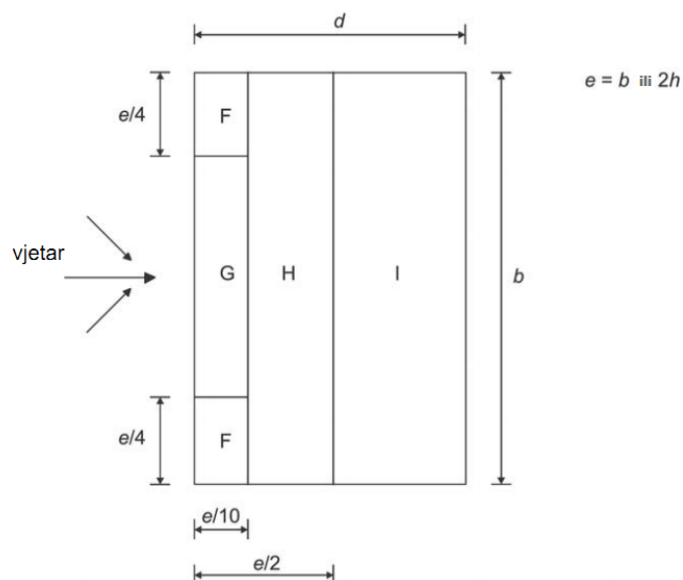

Slika 3.3.6. Koeficijenti vanjskog tlaka za ravne krovove

$$\text{Površina (F)} = (e/4) \cdot (e/10) = (38,16/4) \cdot (38,16/10) = 34,04 \text{ m}^2 > 10 \text{ m}^2$$

$$\rightarrow c_{pe} = c_{pe,10} = -1,8$$

$$\text{Površina (G)} = (b - 2 \cdot 0,25e) \cdot 0,1e = (75,25 - 2 \cdot 0,25 \cdot 38,16) \cdot 0,1 \cdot 38,16 =$$

$$209,59 \text{ m}^2 > 10 \text{ m}^2$$

$$\rightarrow c_{pe} = c_{pe,10} = -1,2$$

$$\text{Površina (H)} = b \cdot (0,5e - 0,1e) = 75,25 \cdot (0,5 \cdot 38,16 - 0,1 \cdot 38,16) =$$

$$1110,69 \text{ m}^2 > 10 \text{ m}^2$$

$$\rightarrow c_{pe} = c_{pe,10} = -0,7$$

$$\text{Površina (I)} = b \cdot (d - 0,5e) = 75,25 \cdot (37,35 - 0,5 \cdot 38,16) = 1422,23 \text{ m}^2 > 10 \text{ m}^2$$

$$\rightarrow c_{pe} = c_{pe,10} = \pm 0,2$$

Koeficijent izloženosti

Teren IV kategorije – područja s najmanje 15% površine pokrivene građevinama čija prosječna visina premašuje 15 m

$$c_e(19,08) = 1,5$$

$$q_p(z_e) = c_e(z) \cdot q_b = 1,5 \cdot 0,391 = 0,587 \text{ kN/m}^2$$

Djelovanje vjetra na ravne krovove

$$w_e = q_b \cdot c_e(z) \cdot c_{pe}$$

$$w_e^F = 0,587 \cdot (-1,8) = -1,060 \text{ kN/m}^2$$

$$w_e^G = 0,587 \cdot (-1,2) = -0,707 \text{ kN/m}^2$$

$$w_e^H = 0,587 \cdot (-0,7) = -0,412 \text{ kN/m}^2$$

$$w_e^I = 0,587 \cdot (0,2) = +0,118 \text{ kN/m}^2$$

$$w_e^{II} = 0,587 \cdot (-0,2) = -0,118 \text{ kN/m}^2$$

Unutarnji tlak

Djelovanje vjetra na sve površine $c_{pi} = +0,2$

$$w_i = 0,587 \cdot (0,2) = 0,118 \text{ kN/m}^2$$

Tlak na površinu je algebarski zbroj unutarnjeg i vanjskog tlaka:

$$w_k^A = w_e^A - w_i = -0,704 - 0,118 = -0,822 \text{ kN/m}^2$$

$$w_k^B = w_e^B - w_i = -0,469 - 0,118 = -0,587 \text{ kN/m}^2$$

$$w_k^D = w_e^D - w_i = +0,469 - 0,118 = +0,351 \text{ kN/m}^2$$

$$w_k^E = w_e^E - w_i = -0,293 - 0,118 = -0,411 \text{ kN/m}^2$$

$$w_k^F = w_e^F - w_i = -1,060 - 0,118 = -1,178 \text{ kN/m}^2$$

$$w_k^G = w_e^G - w_i = -0,707 - 0,118 = -0,825 \text{ kN/m}^2$$

$$w_k^H = w_e^H - w_i = -0,412 - 0,118 = -0,530 \text{ kN/m}^2$$

$$w_{k1}^I = w_e^I - w_i = +0,118 - 0,118 = 0,000 \text{ kN/m}^2$$

$$w_{k2}^I = w_e^I - w_i = -0,118 - 0,118 = -0,236 \text{ kN/m}^2$$

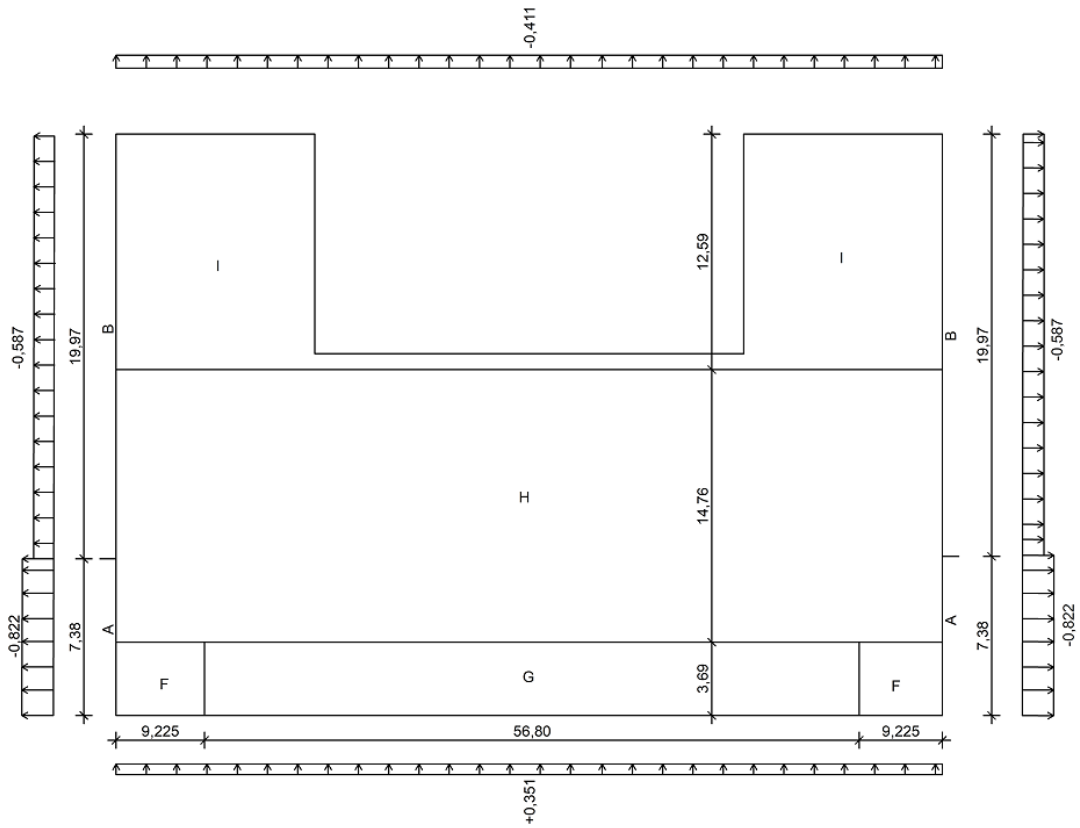

VJETAR

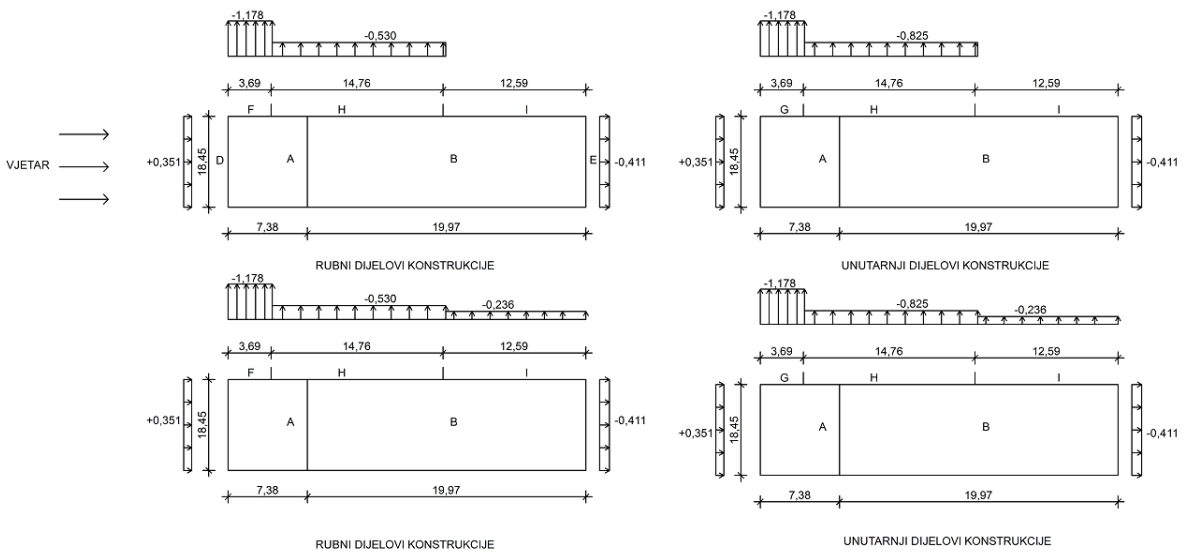

Slika 3.3.7. Opterećenje vjetrom [kN/m²]: Slučaj 1 – transversalni tlak, $c_{pi} = + 0,2$

3.3.6. Slučaj 2 – vjetar puše na uzdužnu stranu objekta, $c_{pi} = - 0,3$

Vanjski tlak

Isti kao i u slučaju 1.

Unutarnji tlak

Djelovanje vjetra na sve površine $c_{pi} = -0,3$

$$w_i = 0,587 \cdot (-0,3) = -0,178 \text{ kN/m}^2$$

Tlak na površinu je algebarski zbroj unutarnjeg i vanjskog tlaka:

$$w_k^A = w_e^A - w_i = -0,704 - (-0,178) = -0,526 \text{ kN/m}^2$$

$$w_k^B = w_e^B - w_i = -0,469 - (-0,178) = -0,291 \text{ kN/m}^2$$

$$w_k^D = w_e^D - w_i = +0,587 - (-0,178) = +0,409 \text{ kN/m}^2$$

$$w_k^E = w_e^E - w_i = -0,293 - (-0,178) = -0,115 \text{ kN/m}^2$$

$$w_k^F = w_e^F - w_i = -1,060 - (-0,178) = -0,882 \text{ kN/m}^2$$

$$w_k^G = w_e^G - w_i = -0,707 - (-0,178) = -0,529 \text{ kN/m}^2$$

$$w_k^H = w_e^H - w_i = -0,412 - (-0,178) = -0,234 \text{ kN/m}^2$$

$$w_{k1}^I = w_e^I - w_i = +0,118 - (-0,178) = +0,296 \text{ kN/m}^2$$

$$w_{k2}^I = w_e^{II} - w_i = -0,118 - (-0,178) = -0,060 \text{ kN/m}^2$$

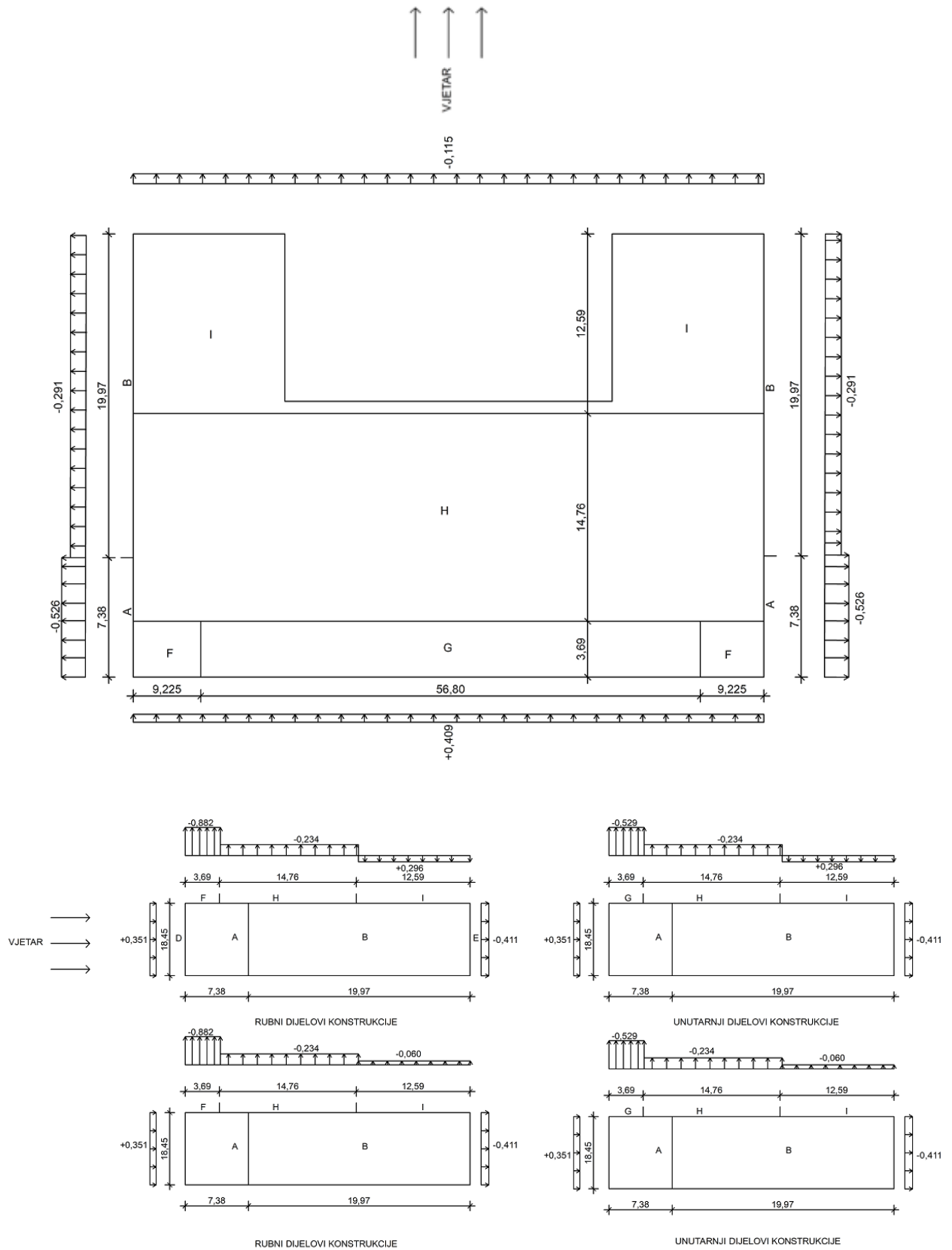

Slika 3.3.8. Opterećenje vjetrom [kN/m^2]: Slučaj 2 – transverzalni tlak, $c_{pi} = -0,3$

3.3.7. Slučaj 3 – vjetar puše na poprečnu stranu objekta $c_{pi} = +0,2$

Vanjski tlak

Vanjski tlak na vertikalne stijene

Referentna visina:

$$z_e = f_c \left(\frac{h}{b} \right)$$

gdje je:

$$h = 19,08 \text{ m}$$

$$b = 27,35 \text{ m (širina površine na koju puše vjetar)}$$

$$h \leq b \rightarrow z_e = h = 19,08 \text{ m}$$

Koeficijent tlaka na vertikalne stijene

$$e = \min(b; 2h) = \min(27,35; 38,16) = 27,35 \text{ m}$$

$$d = 75,25 \text{ m} \rightarrow e < d$$

$$h / d = 19,08 / 75,25 = 0,245$$

$$\text{Površina (A)} = (e/5) \cdot h = (27,35/5) \cdot 19,08 = 100,920 \text{ m}^2 > 10 \text{ m}^2$$

$$\rightarrow c_{pe} = c_{pe,10} = -1,2$$

$$\text{Površina (B)} = (4/5) \cdot e \cdot h = (4/5) \cdot 27,35 \cdot 19,08 = 403,686 \text{ m}^2 > 10 \text{ m}^2$$

$$\rightarrow c_{pe} = c_{pe,10} = -0,8$$

$$\text{Površina (C)} = (d-e) \cdot h = (75,25 - 27,35) \cdot 19,08 = 885,603 \text{ m}^2 > 10 \text{ m}^2$$

$$\rightarrow c_{pe} = c_{pe,10} = -0,5$$

$$\text{Površina (D)} = b \cdot h = 27,35 \cdot 19,08 = 504,608 \text{ m}^2$$

$$\rightarrow c_{pe} = c_{pe,10} = +0,7$$

$$\text{Površina (E)} = b \cdot h = 27,35 \cdot 19,08 = 504,608 \text{ m}^2$$

$$\rightarrow c_{pe} = c_{pe,10} = -0,3$$

Koeficijent izloženosti

Teren IV kategorije – područja s najmanje 15% površine pokrivena građevinama čija prosječna visina premašuje 15 m

$$c_e(19,08) = 1,5$$

$$q_p(z_e) = c_e(z) \cdot q_b = 1,5 \cdot 0,391 = 0,587 \text{ kN/m}^2$$

Djelovanje vjetra na vertikalne površine

$$w_e = q_b \cdot c_e(z) \cdot c_{pe}$$

$$w_e^A = 0,587 \cdot (-1,2) = -0,704 \text{ kN/m}^2$$

$$w_e^B = 0,587 \cdot (-0,8) = -0,469 \text{ kN/m}^2$$

$$w_e^C = 0,587 \cdot (-0,5) = -0,294 \text{ kN/m}^2$$

$$w_e^D = 0,587 \cdot (+0,8) = +0,469 \text{ kN/m}^2$$

$$w_e^E = 0,587 \cdot (-0,5) = -0,294 \text{ kN/m}^2$$

Vanjski tlak na krovnu plohu

Referentna visina:

$$z_e = f_c \left(\frac{h}{b} \right)$$

gdje je:

$$h = 19,08 \text{ m}$$

$$b = 27,35 \text{ m (širina površine na koju puše vjetar)}$$

$$h \leq b \rightarrow z_e = h = 19,08 \text{ m}$$

Koeficijent tlaka na vertikalne stijene

$$e = \min (b ; 2h) = \min (27,35 ; 38,16) = 27,35 \text{ m}$$

$$d = 75,25 \text{ m} \rightarrow e < d$$

$$h / d = 19,08 / 75,25 = 0,245$$

$$\text{Površina (F)} = (e/4) \cdot (e/10) = (27,35/4) \cdot (27,35/10) = 18,701 \text{ m}^2 > 10 \text{ m}^2$$

$$\rightarrow C_{pe} = C_{pe,10} = -1,8$$

$$\text{Površina (G)} = (b - 2 \cdot 0,25e) \cdot 0,1e = (27,35 - 2 \cdot 0,25 \cdot 27,35) \cdot 0,1 \cdot 27,35 = 37,401 \text{ m}^2 > 10 \text{ m}^2$$

$$\rightarrow C_{pe} = C_{pe,10} = -1,2$$

$$\text{Površina (H)} = b \cdot (0,5e - 0,1e) = 27,35 \cdot (0,5 \cdot 27,35 - 0,1 \cdot 27,35) = 299,209 \text{ m}^2 > 10 \text{ m}^2$$

$$\rightarrow C_{pe} = C_{pe,10} = -0,7$$

$$\text{Površina (I)} = b \cdot (d - 0,5e) = 27,35 \cdot (75,25 - 0,5 \cdot 27,35) = 1684,08 \text{ m}^2 > 10 \text{ m}^2$$

$$\rightarrow C_{pe} = C_{pe,10} = \pm 0,2$$

Koeficijent izloženosti

Teren IV kategorije – područja s najmanje 15% površine pokrivene građevinama čija prosječna visina premašuje 15 m

$$c_e(19,08) = 1,5$$

$$q_p(z_e) = c_e(z) \cdot q_b = 1,5 \cdot 0,391 = 0,587 \text{ kN/m}^2$$

Djelovanje vjetra na ravne krovove

$$w_e = q_b \cdot c_e(z) \cdot c_{pe}$$

$$w_e^F = 0,587 \cdot (-1,8) = -1,060 \text{ kN/m}^2$$

$$w_e^G = 0,587 \cdot (-1,2) = -0,707 \text{ kN/m}^2$$

$$w_e^H = 0,587 \cdot (-0,7) = -0,412 \text{ kN/m}^2$$

$$w_e^I = 0,587 \cdot (0,2) = +0,118 \text{ kN/m}^2$$

$$w_e^J = 0,587 \cdot (-0,2) = -0,118 \text{ kN/m}^2$$

Unutarnji tlak

Pritisak vjetra

$$w_i = q_b \cdot c_e(z_i) \cdot c_{pi}$$

Referentna visina

$$z_i = 19,08 \text{ m}$$

Koeficijent unutrašnjeg tlaka vjetra c_{pi}

$$c_{pi} = +0,2 \quad \text{kad vjetar izaziva tlak iznutra ili}$$

Djelovanje vjetra na sve unutrašnje površine $c_{pi} = +0,2$

$$w_i = 0,587 \cdot (+0,2) = 0,118 \text{ kN/m}^2$$

$$w_k^A = w_e^A - w_i = -0,704 - (+0,118) = -0,822 \text{ kN/m}^2$$

$$w_k^B = w_e^B - w_i = -0,469 - (+0,118) = -0,589 \text{ kN/m}^2$$

$$w_k^C = w_e^C - w_i = -0,294 - (+0,118) = -0,412 \text{ kN/m}^2$$

$$w_k^D = w_e^D - w_i = +0,469 - (+0,118) = +0,351 \text{ kN/m}^2$$

$$w_k^E = w_e^E - w_i = -0,294 - (+0,118) = -0,412 \text{ kN/m}^2$$

$$w_k^F = w_e^F - w_i = -1,060 - (+0,118) = -1,178 \text{ kN/m}^2$$

$$w_k^G = w_e^G - w_i = -0,707 - (+0,118) = -0,825 \text{ kN/m}^2$$

$$w_k^H = w_e^H - w_i = -0,412 - (+0,118) = -0,530 \text{ kN/m}^2$$

$$w_{k1}^I = w_e^I - w_i = +0,118 - (+0,118) = 0,000 \text{ kN/m}^2$$

$$w_{k2}^J = w_e^J - w_i = -0,118 - (+0,118) = -0,236 \text{ kN/m}^2$$

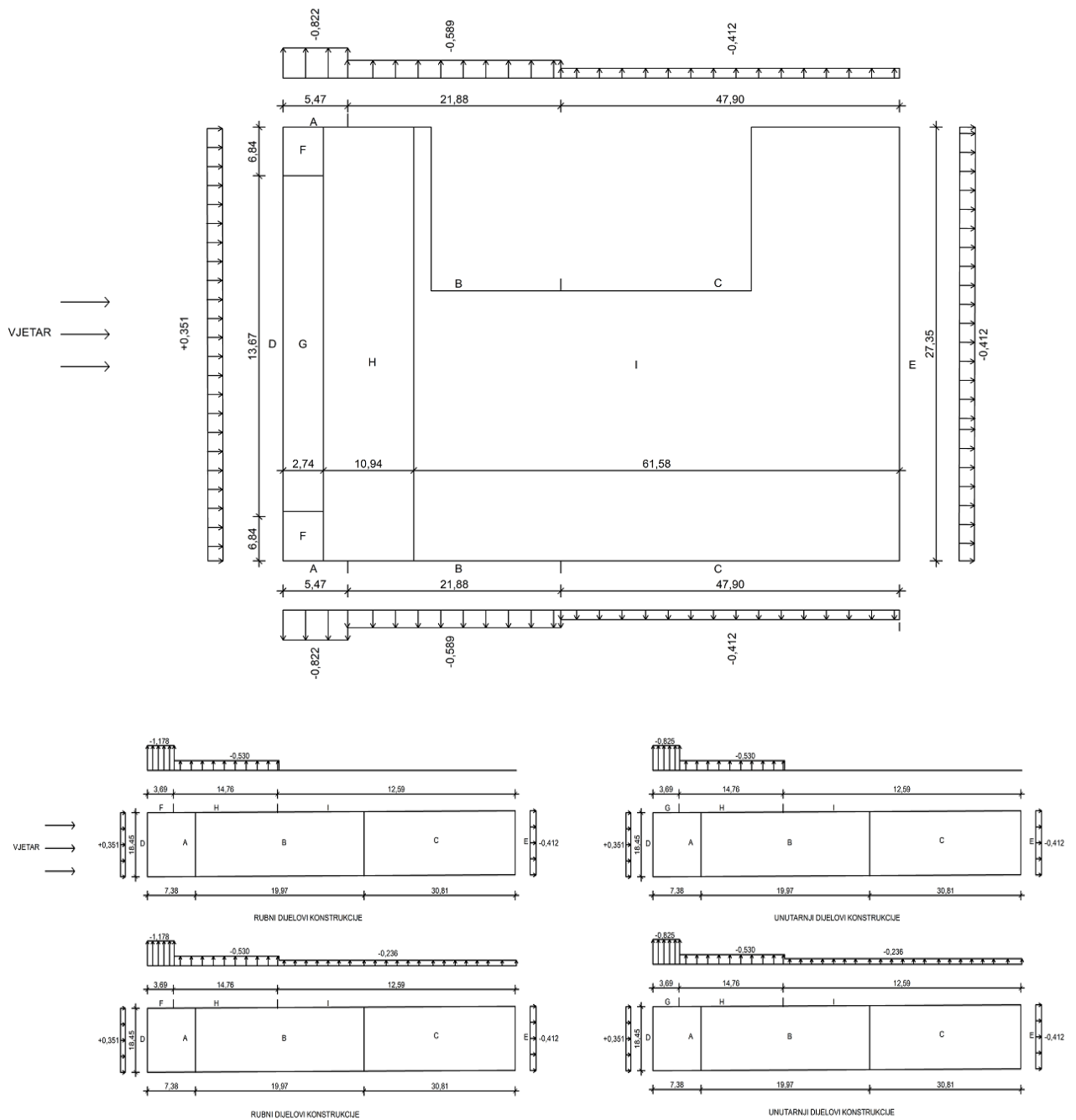

Slika 3.3.9. Opterećenje vjetrom [kN/m^2]: Slučaj 3 – longitudinalni tlak, $c_{pi} = +0,2$

3.3.8. Slučaj 4 – vjetar puše na poprečnu stranu objekta, $c_{pi} = -0,3$

Vanjski i unutrašnji tlak

Isti kao i u slučaju 2.

Djelovanje vjetra na sve površine $c_{pi} = -0,3$

$$w_i = 0,587 \cdot (-0,3) = -0,178 \text{ kN/m}^2$$

Tlak na površinu je algebarski zbroj unutarnjeg i vanjskog tlaka:

$$w_k^A = w_e^A - w_i = -0,704 - (-0,178) = -0,526 \text{ kN/m}^2$$

$$w_k^B = w_e^B - w_i = -0,469 - (-0,178) = -0,291 \text{ kN/m}^2$$

$$w_k^C = w_e^C - w_i = -0,294 - (-0,178) = -0,116 \text{ kN/m}^2$$

$$w_k^D = w_e^D - w_i = +0,469 - (-0,178) = +0,647 \text{ kN/m}^2$$

$$w_k^E = w_e^E - w_i = -0,294 - (-0,178) = -0,116 \text{ kN/m}^2$$

$$w_k^F = w_e^F - w_i = -1,060 - (-0,178) = -0,882 \text{ kN/m}^2$$

$$w_k^G = w_e^G - w_i = -0,707 - (-0,178) = -0,529 \text{ kN/m}^2$$

$$w_k^H = w_e^H - w_i = -0,412 - (-0,178) = -0,234 \text{ kN/m}^2$$

$$w_{k1}^I = w_e^I - w_i = +0,118 - (-0,178) = +0,296 \text{ kN/m}^2$$

$$w_{k2}^I = w_e^{II} - w_i = -0,118 - (-0,178) = -0,060 \text{ kN/m}^2$$

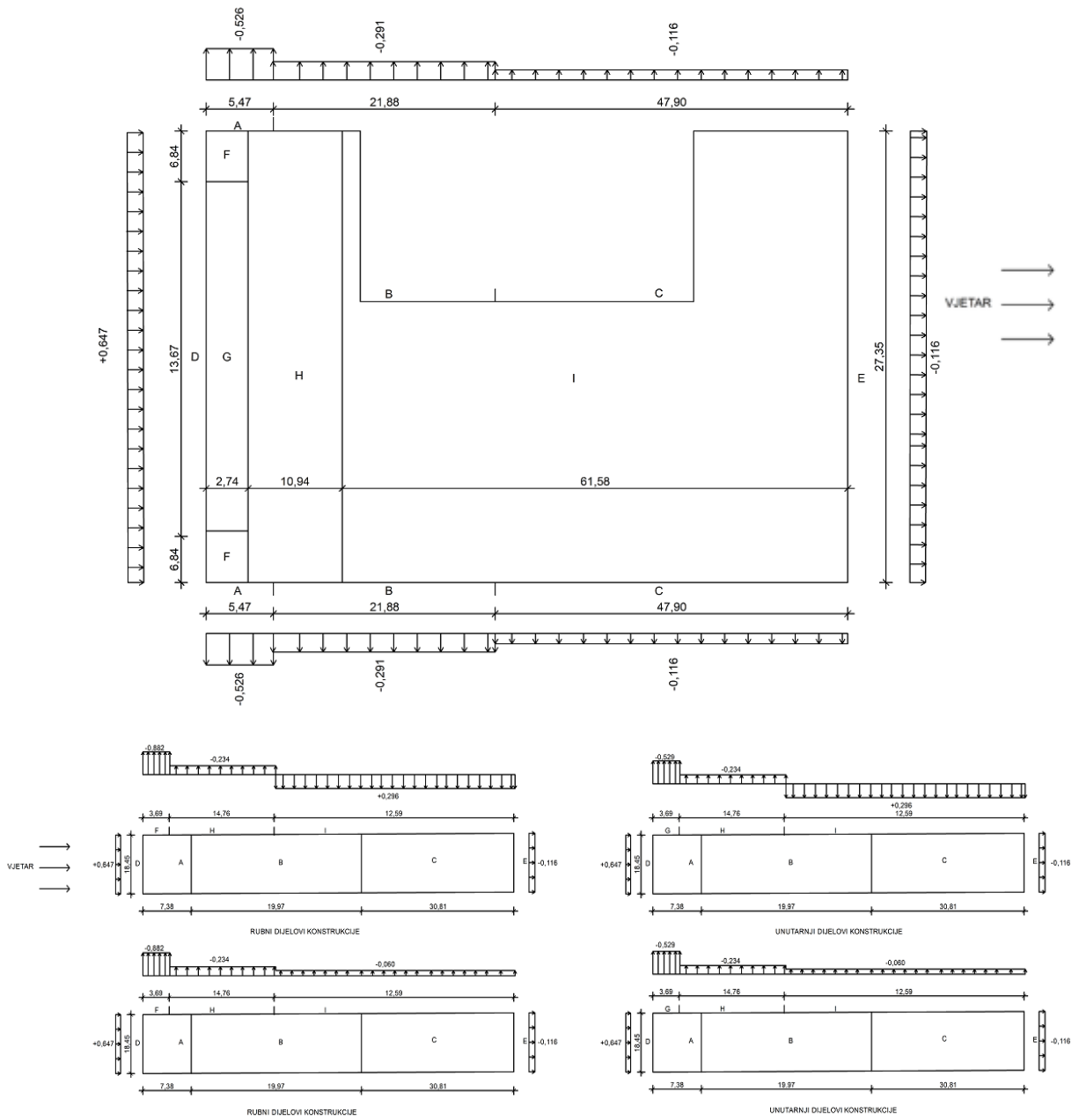

Slika 3.3.10. Opterećenje vjetrom [kN/m²]: Slučaj 4 – longitudinalni tlak, $c_{pi} = -0,3$

3.3.9. Potres

Prema HRN EN 1998-1 [4]



Slika 3.3.11. Prikaz povratnih perioda i ubrzanja tla za odabranu lokaciju

- Razred tla (pretpostavka): C
- Razred važnosti zgrade: II $\gamma_I = 1,0$

Vrijednosti parametara kojima se opisuje horizontalni elastični spektar odziva za potres Tipa 1:

Razred tla	S	b	T _B	T _C	T _D
A	1,00	0,2	0,15	0,40	2,0
B	1,20	0,2	0,15	0,50	2,0
C	1,15	0,2	0,20	0,60	2,0
D	1,35	0,2	0,20	0,80	2,0
E	1,40	0,2	0,15	0,50	2,0

Projektni spektar za elastični proračun

Kako bi se izbjegao nelinearni proračun konstrukcije, kapacitet gubljenja energije konstrukcije uzima se u obzir koristeći linearni proračun konstrukcije zasnovan na reduciranom elastičnom spektru odziva ubrzanja tla. Redukcija se vrši uvođenjem faktora ponašanja q .

$$0 \leq T \leq T_B \quad S_d(T) = \alpha_g \times S \times [2/3 + T/T_B \times (2,5/q - 2/3)]$$

$$T_B \leq T \leq T_C \quad S_d(T) = \alpha_g \times S \times 2,5/q$$

$$T_C \leq T \leq T_D \quad S_d(T) = \alpha_g \times S \times 2,5/q \times [T_C/T] \geq \beta \times \alpha_g$$

$$T_D < T \quad S_d(T) = \alpha_g \times S \times 2,5/q \times [T_C \times T_D/T^2] \geq \beta \times \alpha_g$$

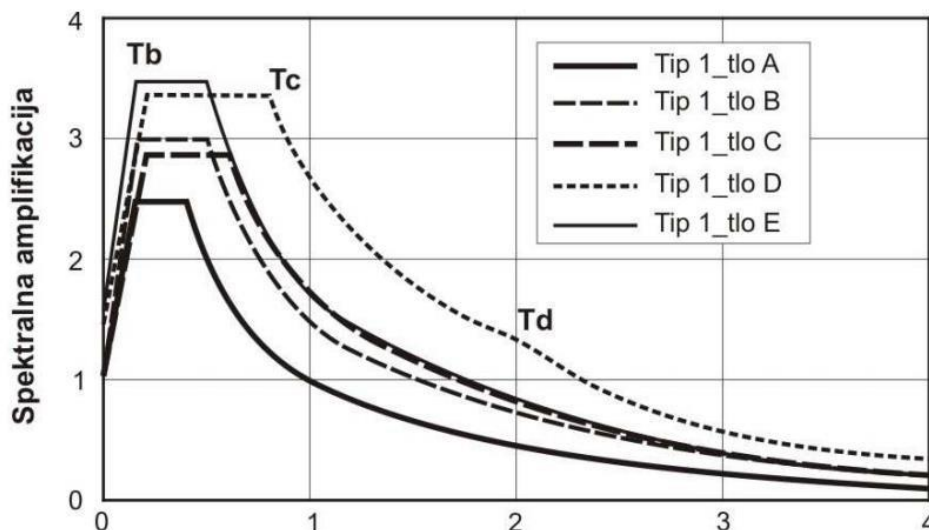

Slika 3.3.12. Elastični spektar odziva Tipa 1

Faktor ponašanja

Način proračuna i razred duktilnosti	q	Primjeri konstrukcija
Mala sposobnost trošenja energije – DCL	1,5	Konzole; grede; dvozglojni ili trozglojni lukovi; rešetke spojene spajalima
Umjerena sposobnost trošenja energije – DCM	2	Lijepljeni zidni paneli s lijepljenim dijafragmama spojeni čavlima i vijcima; rešetke spojene tnovima i vijcima, mješovite konstrukcije od drvenih okvira (koji preuzimaju horizontalne sile) i nenosive ispune
	2,5	Statički neodređeni portalni okviri spojeni tnovima i vijcima (vidjeti točku 8.1.3(3)P)
Velika sposobnost trošenja energije – DCH	3	Zidni paneli spojeni čavlima s lijepljenim dijafragmama spojenim čavlima i vijcima s čavlanim spojevima
	4	Statički neodređeni portalni okviri spojeni tnovima i vijcima (vidjeti točku 8.1.3(3)P)
	5	Zidni paneli spojeni čavlima s dijafragmama spojenim čavlima, spojeni međusobno čavlima i vijcima

Slika 3.3.13. Odabrani faktor ponašanja za drvene konstrukcije prema HRN EN 1998-1

Vertikalna komponenta seizmičkog djelovanja

Vertikalna komponenta potresnog djelovanja prikazuje se elastičnim spektrom odziva.

$$0 \leq T \leq T_B \quad S_{ve}(T) = \alpha_{vg} \times [1 + T/T_B \times (\eta \times 3,0 - 1)]$$

$$T_B \leq T \leq T_C \quad S_{ve}(T) = \alpha_{vg} \times S \times \eta \times 3,0$$

$$T_C \leq T \leq T_D \quad S_{ve}(T) = \alpha_{vg} \times \eta \times 3,0 \times [T_C/T]$$

$$T_D < T \quad S_{ve}(T) = \alpha_{vg} \times \eta \times 3,0 \times [T_C \times T_D/T^2]$$

Vrijednosti parametara kojima se opisuje vertikalni elastični spektar odziva za potres Tipa 1:

α_{vg}/α_g	S	T_B (s)	T_C (s)	T_D (s)
0,90	1,0	0,05	0,15	1,0

Uvjet za uzimanje u obzir vertikalne komponente potresnog djelovanja:

$$\alpha_{vg} > 0,25g$$

$$\alpha_{vg} = 0,9 \alpha_g = 0,9 \times 0,24g = 0,22g < 0,25g$$

UVJET NIJE ISPUNJEN – NIJE POTREBNO UZIMATI U OBZIR VERTIKALNU KOMPONENTU SEIZMIČKOG DJELOVANJA.



3.4. Globalni statički proračun konstrukcije (P+5)

Monika Spajić
Jurunska ulica 2, 10000 Zagreb



Model:
DIPLOMSKI_03_09_2024
model

Date 10.9.2024 Page 1/39
Sheet 1

MODEL

CONTENTS

1	Basic Objects	2	4.4.2	LC11: Loading, In Axonometric Direction	21
1.1	Materials	2	4.5	LC12 - Vjetar odizujući	22
1.2	Sections	2	4.5.1	Surface Loads	22
1.3	Thicknesses	2	4.5.2	LC12: Loading, In Axonometric Direction	24
1.3.1	Thicknesses - Layer Info	3	5	Dynamic Loads	25
1.3.2	Thicknesses - Layers	3	5.1	Response Spectra	25
1.3.3	Thicknesses - Options for CLT	3	5.1.1	Response Spectra - Parameters	25
1.4	Model, In Axonometric Direction	4	6	Static Analysis Results	25
1.5	Model, In Axonometric Direction	5	6.1	CO10: Basic Internal Forces n_x , In Axonometric Direction	26
1.6	Model, In Axonometric Direction	6	6.2	CO10: Basic Internal Forces m_x , In Axonometric Axonometric Direction	27
2	Load Cases & Combinations	7	6.3	CO10: Basic Internal Forces m_y , In Axonometric Axonometric Direction	28
2.1	Load Cases	7	6.4	CO10: Basic Internal Forces n_y , In Axonometric Direction	29
2.2	Static Analysis Settings	8	6.5	CO80: Global Deformations u_j , In Axonometric Direction	30
2.3	Modal Analysis Settings	8	6.6	RC4: Envelope Values - Max and Min Values, Forces v_x , In Axonometric Direction	31
2.4	Spectral Analysis Settings	9	6.7	RC4: Envelope Values - Max and Min Values, Forces n_x , In Axonometric Direction	32
2.5	Combination Wizards	9	6.8	RC4: Envelope Values - Max and Min Values, Forces v_y , In Axonometric Direction	33
2.5.1	Combination Wizards - Initial State Items	9	7	Modal Analysis Results	34
2.6	Response Spectra Diagram	10	7.1	Natural Frequencies	34
3	Load Wizards	10	7.2	Effective Modal Masses	34
3.1	Wind Profiles	10	7.3	Effective Modal Masses - Equivalent Mass per Unit Length	34
3.1.1	Wind Profile - Parameters	10	7.4	LC9: Mode Shape u_j , In Axonometric Direction	36
4	Loads	11	7.5	LC9: Mode Shape u_j , In Axonometric Direction	37
4.1	LC2 - Dodatno stalno	11	7.6	LC9: Mode Shape u_j , In Axonometric Direction	38
4.1.1	Surface Loads	11	7.7	LC9: Mode Shape u_j , In Axonometric Direction	39
4.1.2	LC2: Loading, In Axonometric Direction	12			
4.2	LC3 - Uporabno	13			
4.2.1	Surface Loads	13			
4.2.2	LC3: Loading, In Axonometric Direction	15			
4.3	LC4 - Srijeg	16			
4.3.1	Surface Loads	16			
4.3.2	LC4: Loading, In Axonometric Direction	17			
4.4	LC11 - Vjetar pritisakajući	18			
4.4.1	Surface Loads	18			





Monika Spajić
Jarunska ulica 2, 10000 Zagreb



Model:
DIPLOMSKI_03_09_2024
model

Date 10.9.2024 Page 2/39
Sheet 1

MODEL

1 Basic Objects

1.1 MATERIALS

Legend
Stiffness modification

Material No.	Material Name	Material Type	Analysis Model	Options
6	Stora Enso (40 mm) Orthotropic Linear Elastic (Surfaces)	Timber	Orthotropic Linear Elastic (Surfaces)	☒
7	C 35/40 beton	Concrete	Isotropic Linear Elastic	
8	GL32h Isotropic Linear Elastic	Timber	Isotropic Linear Elastic	☒
9	S355 Isotropic Linear Elastic	Steel	Isotropic Linear Elastic	
10	Stora Enso (30 mm) Orthotropic Linear Elastic (Surfaces)	Timber	Orthotropic Linear Elastic (Surfaces)	☒
11	Stora Enso (20 mm) Orthotropic Linear Elastic (Surfaces)	Timber	Orthotropic Linear Elastic (Surfaces)	☒

1.2 SECTIONS

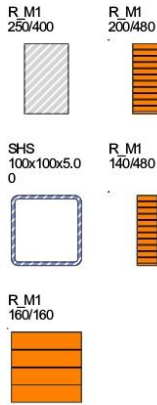

Section No.	Material No.	Section Type	Manufacturing Type	I_x [cm ⁴]	I_y [cm ⁴]	I_z [cm ⁴]	Overall Dimensions		
				A [cm ²]	A _y [cm ²]	A _z [cm ²]	b [mm]	h [mm]	
1	7	R_M1 250/400 7 - C 35/40 beton	Parametric - Massive I	127345.16	133333.33	52083.33	250.0	400.0	
				1000.00	833.33	833.33			
2	8	R_M1 200/480 8 - GL32h	Parametric - Massive I	94484.39	184320.00	32000.00	200.0	480.0	
				960.00	800.00	800.00			
3	9	SHS 100x100x5.00 9 - S355	Standardized - Steel	Cold formed	440.51	271.02	271.02	100.0	100.0
					18.35	8.05	8.05		
4	8	R_M1 140/480 8 - GL32h	Parametric - Massive I	3594.151	129024.00	10976.00	140.0	480.0	
				672.00	560.00	560.00			
5	8	R_M1 160/160 8 - GL32h	Parametric - Massive I	9229.65	546.133	546.133	160.0	160.0	
				256.00	213.33	213.33			

1.3 THICKNESSES

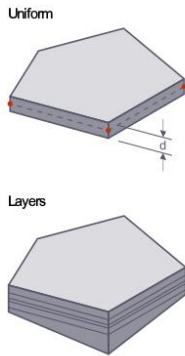

Thick. No.	Type	Assigned to Surface No.	Material	Symbol	Thickness Value	Unit	Nodes	Direction
2	CLT-200 Layers	18-21,23-34,42-45,49-52,57,262-264,268-270,293,302,303,306,313,362,366,674-679						
3	CLT-140 Layers	14,16,17,22,35,38,46,47,54-56,60-62,67,68,70-77,81,84,86,87,90,93,96,99,105,106,108,109,111,112,114,115,117,118,120,121,123-126,130,131,133-135,141,179-181,185,186,191-193,195,197,198,200,201,204,206,207,209,210,212,213,215,216,218,219,222,225,226,228-230,233,237,250,253,255,258,265-267,272,274,278-284,286-290,294,298,300,301,304,305,316,318,320,324,327,329-335,341,347,348,357,358,417-422,424-427,432-461,464-497,506-512,515,518,519,521-524,526-539,543-547,549-563,567-572,603-609,613-621,628,631-637,657,658,665,672,673,680-689,695-726,730-744,784-790,793-801,803,804,806-813						
4	BETON-ZIDOM Uniform	1,	7	d	200.0	mm		





Monika Spajić
Jarunska ulica 2, 10000 Zagreb



Model:
DIPLOMSKI_03_09_2024
model

Date 10.9.2024 Page 3/39
Sheet 1

MODEL

1.3 THICKNESSES

Thick. No.	Type	Assigned to Surface No.	Material	Symbol	Thickness			Direction
					Value	Unit	Nodes	
		2,4-8,10,12,13,15,36,37,39-41,53,58,59,78-80,82,137,140,239,242,244,246,259,271,276,277,285,307-311,314,399,412,416,428-431,462,463,500-505,514,516,517,525,540-542,564,566,588,611,612,622,623,642,654,660,664,666-668,690-694,727-729,759,760						
5	CLT-240-PLOČA Layers	3,9,11,48,63-66,69,83,85,91,92,94,95,97,98,100-104,107,110,113,116,119,122,127-129,132,136,138,139,142-178,182-184,187-190,194,196,199,202,203,205,208,211,214,217,220,221,223,224,227,231,232,234-236,238,240,241,243,245,247-249,251,252,254,256,257,260,261,273,275,291,292,295-297,299,312,315,317,319,321-323,325,326,328,336-340,342-346,349-356,359-361,363-365,367-398,400-402,404-411,413-415,423,498,499,513,520,548,565,573-587,589-602,610,624-627,629,630,638-641,643-653,655,656,659,661-663,669-671,745-758,761-783,791,792,802,805						

1.3.1 THICKNESSES - LAYER INFO

Thick. No.	Total Thickness d [mm]	Total Weight g [N/m²]	Direction of Main Thickness	Comment
2	200.0	1000.0	90.00	
3	140.0	700.0	0.00	
5	240.0	1200.0	0.00	

1.3.2 THICKNESSES - LAYERS

Thick. No.	Layer No.	Object	Material	Thickness t [mm]	Rotation β [deg]	Number of Int. Points	Spec. W. g [N/m²]	Weight g [N/m²]
2	1	Directly	6	40.0	90.00	9	5000.0	200.0
	2	Directly	6	40.0	0.00	9	5000.0	200.0
	3	Directly	6	40.0	90.00	9	5000.0	200.0
	4	Directly	6	40.0	0.00	9	5000.0	200.0
	5	Directly	6	40.0	90.00	9	5000.0	200.0
3	1	Directly	10	30.0	0.00	9	5000.0	150.0
	2	Directly	10	30.0	90.00	9	5000.0	150.0
	3	Directly	11	20.0	0.00	9	5000.0	100.0
	4	Directly	10	30.0	90.00	9	5000.0	150.0
	5	Directly	10	30.0	0.00	9	5000.0	150.0
5	1	Directly	10	30.0	0.00	9	5000.0	150.0
	2	Directly	6	40.0	90.00	9	5000.0	200.0
	3	Directly	10	30.0	0.00	9	5000.0	150.0
	4	Directly	6	40.0	90.00	9	5000.0	200.0
	5	Directly	10	30.0	0.00	9	5000.0	150.0
	6	Directly	6	40.0	90.00	9	5000.0	200.0
	7	Directly	10	30.0	0.00	9	5000.0	150.0

1.3.3 THICKNESSES - OPTIONS FOR CLT

Thick. No.	Name	Symbol	Value	Unit
2	Design for failure of net section and failure in glued contact surface is enabled.		<input type="checkbox"/>	
3	Design for failure of net section and failure in glued contact surface is enabled.		<input type="checkbox"/>	
5	Design for failure of net section and failure in glued contact surface is enabled.		<input type="checkbox"/>	



Monika Spajić
Jarunska ulica 2, 10000 Zagreb



Model:
DIPLOMSKI_03_09_2024
model

Date 10.9.2024 Page 5/39
Sheet 1

MODEL

1.5 **MODEL, IN AXONOMETRIC DIRECTION**

In Axonometric Direction

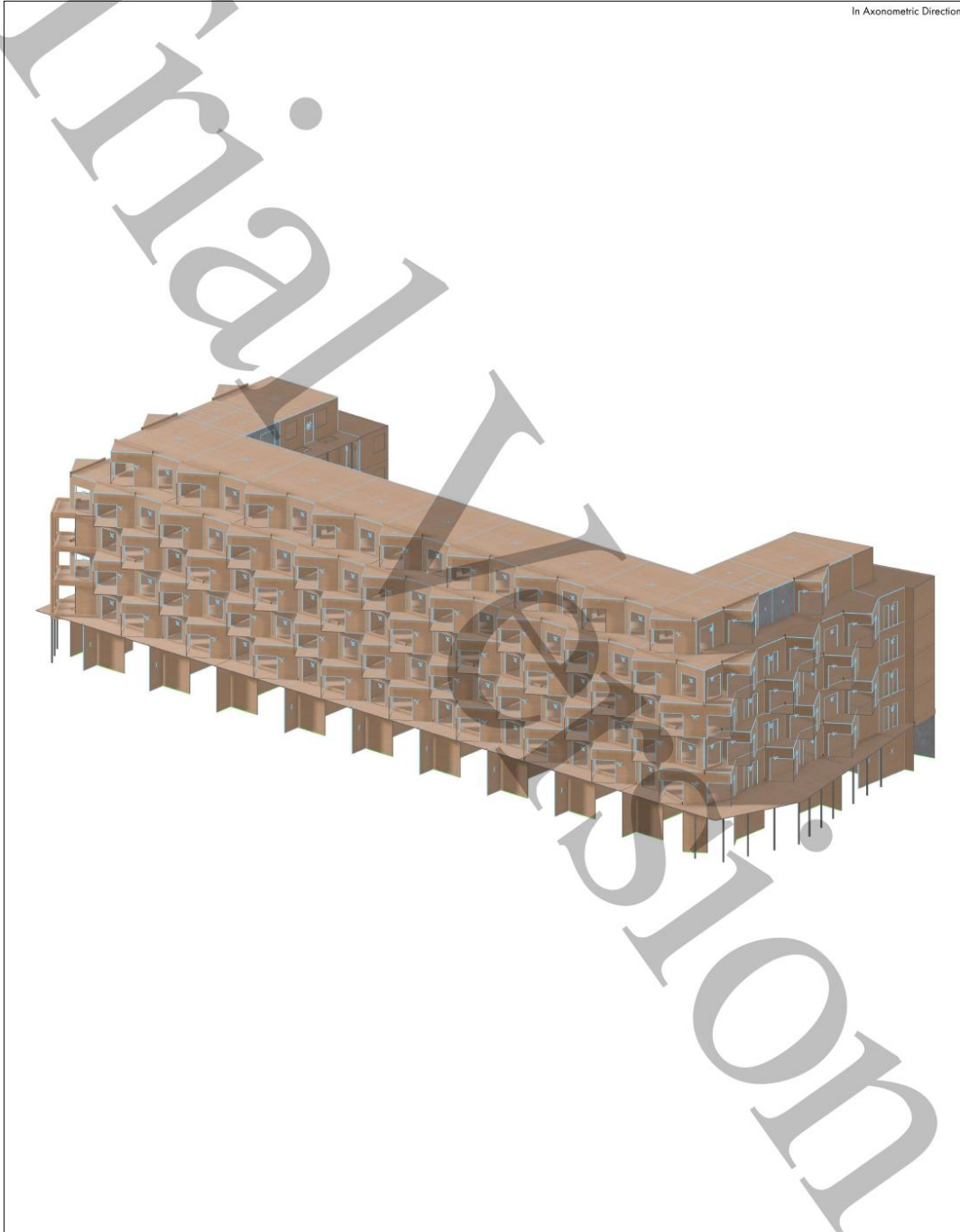

Monika Spajić
Jarunska ulica 2, 10000 Zagreb



Model:
DIPLOMSKI_03_09_2024
model

Date 10.9.2024 Page 6/39
Sheet 1

MODEL

1.6 **MODEL, IN AXONOMETRIC DIRECTION**

In Axonometric Direction





Monika Spajić
Jarunska ulica 2, 10000 Zagreb



Model:
DIPLOMSKI_03_09_2024
model

Date 10.9.2024 Page 7/39
Sheet 1

MODEL

2 Load Cases & Combinations

2.1 LOAD CASES

Legend
+ Accidental torsion

LC No.	Settings	Value	Unit	To Solve	Options
1	Self-weight Analysis type Associated standard Static analysis settings Action category Self-weight - Factor in direction X Self-weight - Factor in direction Y Self-weight - Factor in direction Z Load duration Self-weight mode for geotechnical analysis	Static Analysis EN 1990 Timber CEN 2010-04 SA1 - Geometrically linear Newton-Raphson Permanent 0.000 0.000 1.000 Permanent Normal	- - -	<input checked="" type="checkbox"/>	
2	Dodatno stalno Analysis type Associated standard Static analysis settings Action category Load duration Self-weight mode for geotechnical analysis	Static Analysis EN 1990 Timber CEN 2010-04 SA1 - Geometrically linear Newton-Raphson Permanent/Imposed Permanent Normal		<input checked="" type="checkbox"/>	
3	Uporabno Analysis type Associated standard Static analysis settings Action category Load duration Factor Phi Self-weight mode for geotechnical analysis	Static Analysis EN 1990 Timber CEN 2010-04 SA1 - Geometrically linear Newton-Raphson Imposed loads - category A: domestic, residential areas Medium-term Roofs Normal		<input checked="" type="checkbox"/>	
4	Snjeg Analysis type Associated standard Static analysis settings Action category Load duration Self-weight mode for geotechnical analysis	Static Analysis EN 1990 Timber CEN 2010-04 SA1 - Geometrically linear Newton-Raphson Snow/ice loads - H <= 1000 m Medium-term Normal		<input checked="" type="checkbox"/>	
9	Potres Analysis type Associated standard Modal analysis settings Import masses from Action category Self-weight mode for geotechnical analysis	Modal Analysis EN 1990 Timber CEN 2010-04 MOS1 - #20 Lanczos CO127 Seismic actions Normal		<input checked="" type="checkbox"/>	
10	Spektar Analysis type Associated standard Spectral analysis settings Import modal analysis from Action category Load duration Self-weight mode for geotechnical analysis	Response Spectrum Analysis EN 1990 Timber CEN 2010-04 SPS1 - SRSS Scaled Sum 30.00 % LC9 Seismic actions Instantaneous Normal		<input checked="" type="checkbox"/>	<input checked="" type="checkbox"/>
11	Vjetar pritiskajući Analysis type Associated standard Static analysis settings Action category Load duration Self-weight mode for geotechnical analysis	Static Analysis EN 1990 Timber CEN 2010-04 SA1 - Geometrically linear Newton-Raphson Wind Short-term Normal		<input checked="" type="checkbox"/>	
12	Vjetar odližući Analysis type Associated standard Static analysis settings Action category Load duration Self-weight mode for geotechnical analysis	Static Analysis EN 1990 Timber CEN 2010-04 SA1 - Geometrically linear Newton-Raphson Wind Short-term Normal		<input checked="" type="checkbox"/>	





Monika Spajić
Jarunska ulica 2, 10000 Zagreb



Model:
DIPLOMSKI_03_09_2024
model

Date 10.9.2024 Page 8/39
Sheet 1

MODEL

2.2 **STATIC ANALYSIS SETTINGS**

Settings No.	Description	Symbol	Value	Unit
1	Geometrically linear Newton-Raphson			
	Analysis type		Geometrically linear	
	Iterative method for nonlinear analysis		Newton-Raphson	
	Maximum number of iterations		100	
	Number of load increments		1	
	Modify standard precision and tolerance settings	<input type="checkbox"/>		
	Ignore all nonlinearities	<input type="checkbox"/>		
	Modify loading by multiplier factor	<input type="checkbox"/>		
	Displacements due to member load of type 'Pipe internal pressure' (Bourdon effect)	<input type="checkbox"/>		
	Method for equation system		Direct	
	Plate bending theory		Mindlin	
	Activate mass conversion to load	<input type="checkbox"/>		
	Asymmetric direct solver	<input checked="" type="checkbox"/>		
	Equilibrium for undeformed structure	<input type="checkbox"/>		
	Stability check based on deformation rate	<input type="checkbox"/>		
2	Second-order (P-Δ) Picard 100 1			
	Analysis type		Second-order (P-Δ)	
	Iterative method for nonlinear analysis		Picard	
	Maximum number of iterations		100	
	Number of load increments		1	
	Modify standard precision and tolerance settings	<input type="checkbox"/>		
	Ignore all nonlinearities	<input type="checkbox"/>		
	Modify loading by multiplier factor	<input type="checkbox"/>		
	Consider favorable effect due to tension in members	<input checked="" type="checkbox"/>		
	Displacements due to member load of type 'Pipe internal pressure' (Bourdon effect)	<input type="checkbox"/>		
	Refer internal forces to deformed structure	<input checked="" type="checkbox"/>		
	Refer internal forces to deformed structure for axial forces	<input checked="" type="checkbox"/>		
	Refer internal forces to deformed structure for shear forces	<input checked="" type="checkbox"/>		
	Refer internal forces to deformed structure for moments	<input checked="" type="checkbox"/>		
	Method for equation system		Direct	
	Plate bending theory		Mindlin	
	Activate mass conversion to load	<input type="checkbox"/>		
	Asymmetric direct solver	<input checked="" type="checkbox"/>		
	Equilibrium for undeformed structure	<input type="checkbox"/>		
	Stability check based on deformation rate	<input type="checkbox"/>		

2.3 **MODAL ANALYSIS SETTINGS**

Settings No.	Description	Symbol	Value	Unit
1	#20 Lanczos			
	Number of modes method		User-Defined	
	Number of modes		20	
	Solution method		Lanczos	
	Mass matrix type		Consistent	
	Acting masses in X-direction enabled	Ux	<input checked="" type="checkbox"/>	
	Acting masses in Y-direction enabled	Uy	<input checked="" type="checkbox"/>	
	Acting masses in Z-direction enabled	Uz	<input checked="" type="checkbox"/>	
	Acting masses about X-axis enabled	φx	<input type="checkbox"/>	
	Acting masses about Y-axis enabled	φy	<input type="checkbox"/>	
	Acting masses about Z-axis enabled	φz	<input type="checkbox"/>	
	Mass conversion type		Z-components of loads	
	Neglect masses		No neglection	
2	f _{me} : 30.00 % Root of characteristic polynomial			
	Number of modes method		Automatic, to reach effective modal mass factors	
	Effective modal mass factor	f _{me}	30.00 %	
	Solution method		Root of characteristic polynomial	
	Mass matrix type		Consistent	
	Acting masses in X-direction enabled	Ux	<input checked="" type="checkbox"/>	
	Acting masses in Y-direction enabled	Uy	<input checked="" type="checkbox"/>	
	Acting masses in Z-direction enabled	Uz	<input checked="" type="checkbox"/>	
	Acting masses about X-axis enabled	φx	<input checked="" type="checkbox"/>	
	Acting masses about Y-axis enabled	φy	<input checked="" type="checkbox"/>	
	Acting masses about Z-axis enabled	φz	<input checked="" type="checkbox"/>	
	Mass conversion type		Z-components of loads	
	Neglect masses		No neglection	

Monika Spajić
Jarunska ulica 2, 10000 Zagreb



Model:
DIPLOMSKI_03_09_2024
model

Date 10.9.2024 Page 9/39
Sheet 1

MODEL

2.4 SPECTRAL ANALYSIS SETTINGS

Settings No.	Description	Symbol	Value	Unit
1	SRSS Scaled Sum 30.00 %			
	Combination rule for periodic responses	SRSS		
	Use equivalent linear combination	<input type="checkbox"/>		
	Signed results using dominant mode	<input type="checkbox"/>		
	Save results of all selected modes	<input checked="" type="checkbox"/>		
	Combination rule for directional components	Scaled Sum	30.00 %	
	Combination rule for directional components			
	Consider independent directions in envelope results	<input type="checkbox"/>		

2.5 COMBINATION WIZARDS

Wizard No.	Settings	Value
1	Load combinations SA2 - Second-order (P-Δ) Picard 100 1	
	Assigned to	DS 1-4
	Generate combinations	Load combinations (non-linear analysis)
	Static analysis settings	SA2 - Second-order (P-Δ) Picard 100 1
	Consider imperfection case	<input checked="" type="checkbox"/>
	Consider initial state	<input type="checkbox"/>
	Structure modification enabled	<input type="checkbox"/>
	Generate same combinations without imperfection case	<input type="checkbox"/>
	User-defined action combinations	<input type="checkbox"/>
	Favorable permanent actions	<input type="checkbox"/>
	Reduce number of generated combinations	<input type="checkbox"/>
	Assigned to	DS 1-4
	Generate combinations	Load combinations (non-linear analysis)
	Static analysis settings	SA2 - Second-order (P-Δ) Picard 100 1
	Consider imperfection case	<input checked="" type="checkbox"/>
	Consider initial state	<input type="checkbox"/>
	Structure modification enabled	<input type="checkbox"/>
	Generate same combinations without imperfection case	<input type="checkbox"/>
	User-defined action combinations	<input type="checkbox"/>
	Favorable permanent actions	<input type="checkbox"/>
	Reduce number of generated combinations	<input type="checkbox"/>
2	Result combinations	
	Assigned to	DS 5
	Generate combinations	Result combinations (linear analysis)
	Consider imperfection case	<input checked="" type="checkbox"/>
	Generate as permanent superposition	<input checked="" type="checkbox"/>
	User-defined action combinations	<input type="checkbox"/>
	Favorable permanent actions	<input type="checkbox"/>
	Assigned to	DS 5
	Generate combinations	Result combinations (linear analysis)
	Consider imperfection case	<input type="checkbox"/>
	User-defined action combinations	<input type="checkbox"/>
	Favorable permanent actions	<input type="checkbox"/>

2.5.1 COMBINATION WIZARDS - INITIAL STATE ITEMS

Wizard No.	Definition Type	Case Object
1	Load combinations SA2 - Second-order (P-Δ) Picard 100 1	
2	Result combinations	





Monika Spajić
Jarunska ulica 2, 10000 Zagreb



Model:
DIPLOMSKI_03_09_2024
model

Date 10.9.2024 Page 10/39
Sheet 1

MODEL

2.6 RESPONSE SPECTRA | DIAGRAM

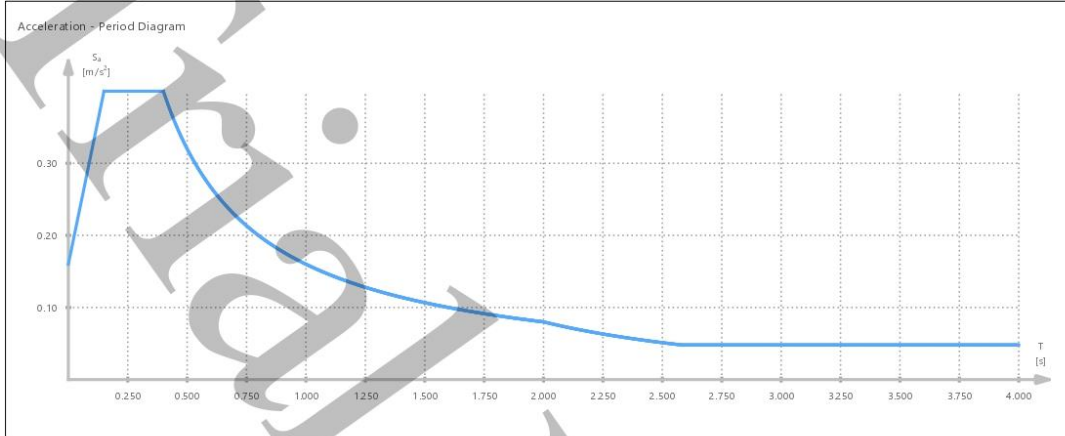

3 Load Wizards

3.1 WIND PROFILES

Profile No.	Profile Type Definition Type	Assigned To Load Zone	Δ_z [m]	Level z [m]	Velocity v [m/s]	Turb. Intensity I [%]
1	According to Standard - EN 1991 CEN 2015-09			0.000	33.65	17.21
	According to Standard - EN 1991 CEN 2015-09			1.245	34.57	16.59
				2.491	37.46	14.88
				3.736	39.14	14.03
				4.981	40.33	13.49
				6.227	41.25	13.09
				7.472	42.00	12.79
				8.717	42.63	12.54
				9.963	43.17	12.33
				11.208	43.66	12.16
				12.453	44.09	12.00
				13.699	44.48	11.87
				14.944	44.83	11.75
			16.189	45.16	11.64	
			17.435	45.46	11.54	
			18.680	45.74	11.45	

3.1.1 WIND PROFILE - PARAMETERS

Profile No.	Description	Symbol	Value	Unit
1	According to Standard - EN 1991 CEN 2015-09			
	Parameters			
	Terrain category		Category 0	
	Structure height	h	18.680	m
	Air density	ρ	1.25	kg/m ³
	Wind velocity			
	Consider mean wind velocity		<input type="checkbox"/>	
	Fundamental wind velocity	$v_{b,0}$	25.00	m/s
	Turbulence intensity			
	Uniform turbulence intensity		<input type="checkbox"/>	
	Coefficients			
	Orography factor	C_o	1.00	-
	Directional factor	C_{dir}	1.00	-
	Seasonal factor	C_{season}	1.00	-
	Turbulence factor	k	1.00	-
Terrain factor				



Monika Spajić
Jarunska ulica 2, 10000 Zagreb



Model:
DIPLOMSKI_03_09_2024
model

Date 10.9.2024 Page 11/39
Sheet 1

MODEL

3.1.1 WIND PROFILE - PARAMETERS

Profile No.	Description	Symbol	Value	Unit
	Manual definition of terrain factor		<input type="checkbox"/>	
	Terrain factor	k _t	0.16	–
	Velocity pressure			
	Basic velocity pressure	q _b	0.39	kN/m ²

4 Loads

4.1 LC2 - Dodatno stalno

4.1.1 SURFACE LOADS

LC2: Dodatno stalno G_q

Load Type 'Force' | Load Distribution 'Uniform'

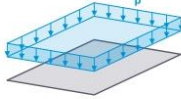

Load No.	Surfaces No.	Load Type	Load Distribution	Coord. System	Load Direction	Symbol	Parameters Value	Unit
1	3,	Force	Uniform	1	Z _A	p	-1.50	kN/m ²
2	11,48,63,64,66,69,1 49,153,155,159,161, 163,165,166,168,16 9,310,311,314,317,3 49-356,360,363,364 ,382-396,412,414,5 14,639,642,646-648 ,651,652,655,659,67 0,671,802	Force	Uniform	1	Z _A	p	1.50	kN/m ²
3	83,85,91,92,94,95,9 7,98,100-104,107,11 0,113,116,119,122,1 27-129,132,136,138 ,139,142-148,150-1 52,154,156-158,160 ,162,164,167,170-1 78,182-184,187-190 ,194,196,199,202,20 3,205,208,211,214,2 17,220,221,223,224, 227,231,232,234-23 6,238,240,241,243,2 45,247-249,251,252 ,254,256,257,260,26 1,273,275,291,292,2 95-297,299,312,315 ,319,321-323,325,3 26,328,336-340,342 -346,359,361,365,3 67-381,397,398,400 402,404-411,413,41 5,423,498,499,513,5 20,548,565,573-587 ,589-602,610,624-6 27,629,630,638,641, 643-645,649,650,65 3,656,661-663,669, 745-758,761-783,79 1,792,805	Force	Uniform	1	Z _A	p	1.50	kN/m ²



Monika Spajić
Jarunska ulica 2, 10000 Zagreb



Model:
DIPLOMSKI_03_09_2024
model

Date 10.9.2024 Page 12/39
Sheet 1

MODEL

4.1.2 LC2: LOADING, IN AXONOMETRIC DIRECTION

LC2 - Dodatno stalno
Loads [kN/m²]

In Axonometric Direction

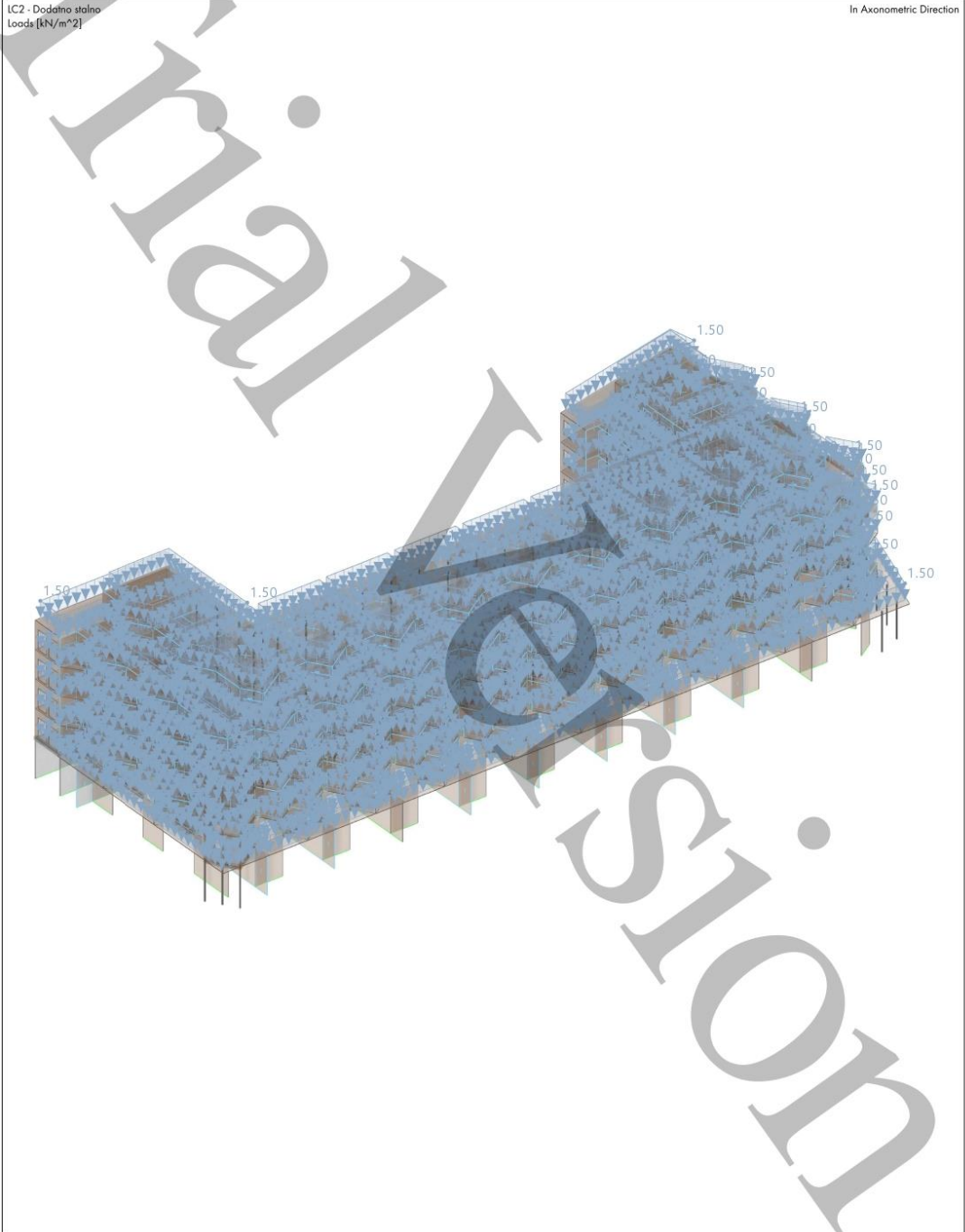



Monika Spajić
Jarunska ulica 2, 10000 Zagreb



Model:
DIPLOMSKI_03_09_2024
model

Date 10.9.2024 Page 13/39
Sheet 1

LOADS

4.2 LC3 - Uporabno

4.2.1 SURFACE LOADS

LC3: Uporabno

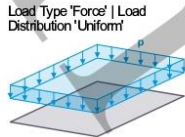

Load No.	Surfaces No.	Load Type	Load Distribution	Coord. System	Load Direction	Symbol	Parameters Value	Unit
1	387-390,392,394,396	Force	Uniform	1	Z _A	p	2.00	kN/m ²
3	640	Force	Uniform	1	Z _A	p	4.00	kN/m ²
4	9,652	Force	Uniform	1	Z _A	p	4.00	kN/m ²
5	63	Force	Uniform	1	Z _A	p	4.00	kN/m ²
6	375	Force	Uniform	1	Z _A	p	2.00	kN/m ²
7	345,359,367,415,423,498,499,513,520,565,574,587,589-596,601,610,625,638	Force	Uniform	1	Z _A	p	4.00	kN/m ²
8	164,170,173,177,183,187,194,202,208,217,223,227,231,236	Force	Uniform	1	Z _A	p	4.00	kN/m ²
9	600	Force	Uniform	1	Z _A	p	4.00	kN/m ²
10	662	Force	Uniform	1	Z _A	p	2.00	kN/m ²
11	240,243,247,251,254,257,261,275,312,319,325,326,337-339,342	Force	Uniform	1	Z _A	p	4.00	kN/m ²
12	3,11,48,153,155,159,161,163,165,166,363,364,382-386,391,393,395,514	Force	Uniform	1	Z _A	p	4.00	kN/m ²
13	761	Force	Uniform	1	Z _A	p	4.00	kN/m ²
14	414	Force	Uniform	1	Z _A	p	4.00	kN/m ²
15	772	Force	Uniform	1	Z _A	p	4.00	kN/m ²
16	762	Force	Uniform	1	Z _A	p	4.00	kN/m ²
17	64,66,69,149,168,169	Force	Uniform	1	Z _A	p	4.00	kN/m ²
18	765,767-771	Force	Uniform	1	Z _A	p	4.00	kN/m ²
19	763	Force	Uniform	1	Z _A	p	4.00	kN/m ²
20	764	Force	Uniform	1	Z _A	p	4.00	kN/m ²
21	381	Force	Uniform	1	Z _A	p	4.00	kN/m ²
22	575,578	Force	Uniform	1	Z _A	p	4.00	kN/m ²
23	370,373,376-380,408,409,411	Force	Uniform	1	Z _A	p	4.00	kN/m ²
24	597,598	Force	Uniform	1	Z _A	p	4.00	kN/m ²
25	626	Force	Uniform	1	Z _A	p	4.00	kN/m ²
26	372	Force	Uniform	1	Z _A	p	2.00	kN/m ²
27	627	Force	Uniform	1	Z _A	p	2.00	kN/m ²
28	410	Force	Uniform	1	Z _A	p	4.00	kN/m ²
31	83,97,101,102,104,107,113,116,122,127,129,132,138,139,143,145,146,148,150-152,158	Force	Uniform	1	Z _A	p	4.00	kN/m ²
32	777-783	Force	Uniform	1	Z _A	p	4.00	kN/m ²
34	745-758	Force	Uniform	1	Z _A	p	0.60	kN/m ²
35	689	Force	Uniform	1	Z _A	p	0.60	kN/m ²
36	776	Force	Uniform	1	Z _A	p	4.00	kN/m ²
37	85,91,92,95	Force	Uniform	1	Z _A	p	4.00	kN/m ²
38	94,98,100,103,110,119,128,136,142,147,154,157,160	Force	Uniform	1	Z _A	p	2.00	kN/m ²
39	668	Force	Uniform	1	Z _A	p	4.00	kN/m ²
40	162,167,171,174,176,182,188,190,199,205,214,221,224,232,235	Force	Uniform	1	Z _A	p	4.00	kN/m ²
41	576,577,579-586,599	Force	Uniform	1	Z _A	p	4.00	kN/m ²
42	144,172,175,178,184,189,196,203,211,220,234,573,602	Force	Uniform	1	Z _A	p	2.00	kN/m ²
43	666	Force	Uniform	1	Z _A	p	4.00	kN/m ²
44	249,252,256,260,273,291,315,322,328,340,624,656	Force	Uniform	1	Z _A	p	2.00	kN/m ²
45	238	Force	Uniform	1	Z _A	p	2.00	kN/m ²
46	792	Force	Uniform	1	Z _A	p	2.00	kN/m ²
47	241,245,248	Force	Uniform	1	Z _A	p	2.00	kN/m ²
48	292,295-297,299,32	Force	Uniform	1	Z _A	p	2.00	kN/m ²





Monika Spajić
Jarunska ulica 2, 10000 Zagreb



Model:
DIPLOMSKI_03_09_2024
model

Date 10.9.2024 Page 14/39
Sheet 1

LOADS

4.2.1

SURFACE LOADS

LC3: Uporabno Q1 A

Load No.	Surfaces No.	Load Type	Load Distribution	Coord. System	Load Direction	Symbol	Parameters Value	Unit
49	1,323 629,630,641,643-64 5,649,650	Force	Uniform	1	Z _x	p	2.00	kN/m ²
50	336	Force	Uniform	1	Z _x	p	2.00	kN/m ²
51	653	Force	Uniform	1	Z _x	p	2.00	kN/m ²
52	661,663	Force	Uniform	1	Z _x	p	2.00	kN/m ²
53		Force	Uniform	1	Z _x	p	2.00	kN/m ²
54	343,344,346,365,36 8,369,397,398,400- 402,404-407,413,54 8,805	Force	Uniform	1	Z _x	p	2.00	kN/m ²
55	371,374	Force	Uniform	1	Z _x	p	2.00	kN/m ²
56	314,317,349-356,36 0,647,648,651,655,6 59,670,671	Force	Uniform	1	Z _x	p	2.00	kN/m ²
57	412,639,642,646	Force	Uniform	1	Z _x	p	2.00	kN/m ²
58	802	Force	Uniform	1	Z _x	p	2.00	kN/m ²
59	310	Force	Uniform	1	Z _x	p	4.00	kN/m ²
60	399	Force	Uniform	1	Z _x	p	4.00	kN/m ²
61	667	Force	Uniform	1	Z _x	p	4.00	kN/m ²
62	588	Force	Uniform	1	Z _x	p	4.00	kN/m ²
63	660	Force	Uniform	1	Z _x	p	4.00	kN/m ²
64	311	Force	Uniform	1	Z _x	p	4.00	kN/m ²
65	664	Force	Uniform	1	Z _x	p	4.00	kN/m ²
66	654	Force	Uniform	1	Z _x	p	4.00	kN/m ²
67	156	Force	Uniform	1	Z _x	p	0.60	kN/m ²
68	773-775	Force	Uniform	1	Z _x	p	4.00	kN/m ²



Monika Spajić
Jarunska ulica 2, 10000 Zagreb



Model:
DIPLOMSKI_03_09_2024
model

Date 10.9.2024 Page 15/39
Sheet 1

MODEL

4.2.2 LC3: LOADING, IN AXONOMETRIC DIRECTION

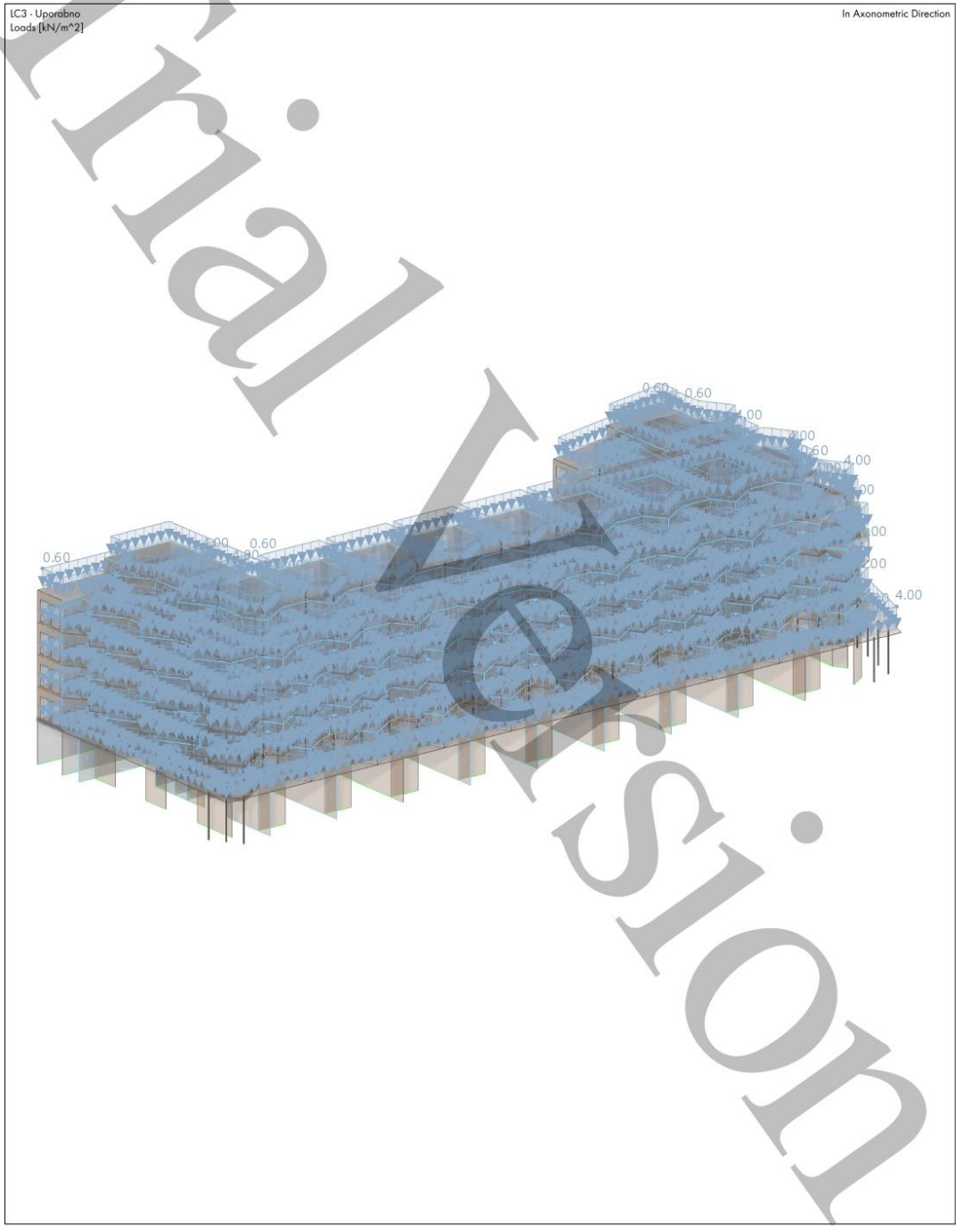

Monika Spajić
Jarunska ulica 2, 10000 Zagreb



Model:
DIPLOMSKI_03_09_2024
model

Date 10.9.2024 Page 16/39
Sheet 1

LOADS

4.3 LC4 - Snijeg

4.3.1

SURFACE LOADS

LC4: Snijeg Qs

Load Type 'Force' | Load Distribution 'Uniform'

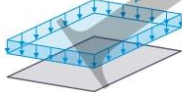

Load No.	Surfaces No.	Load Type	Load Distribution	Coord. System	Load Direction	Symbol	Parameters Value	Unit
1	83,85,91,92,95,97,101,102,104,107,113,116,122,127,129,132,138,139,143,145,146,148,150-152,156,158,164,170,173,177,183,187,194,202,208,217,223,227,231,236,575,578,669,745-758,776-783	Force	Uniform	1	Zx	p	1.00	kN/m ²
2	3,11,48,153,155,159,161,163,165,166,240,243,251,254,257,261,275,312,319,325,337-339,342,345,359,361,363,364,367,370,382-386,391,393,395,415,498,499,514,565,587,590,592,594,596,601,638	Force	Uniform	1	Zx	p	1.00	kN/m ²



Monika Spajić
Jarunska ulica 2, 10000 Zagreb



Model:
DIPLOMSKI_03_09_2024
model

Date 10.9.2024 Page 17/39
Sheet 1

MODEL

4.3.2 LC4: LOADING, IN AXONOMETRIC DIRECTION

LC4 - Snijeg
Loads [kN/m²]

In Axonometric Direction

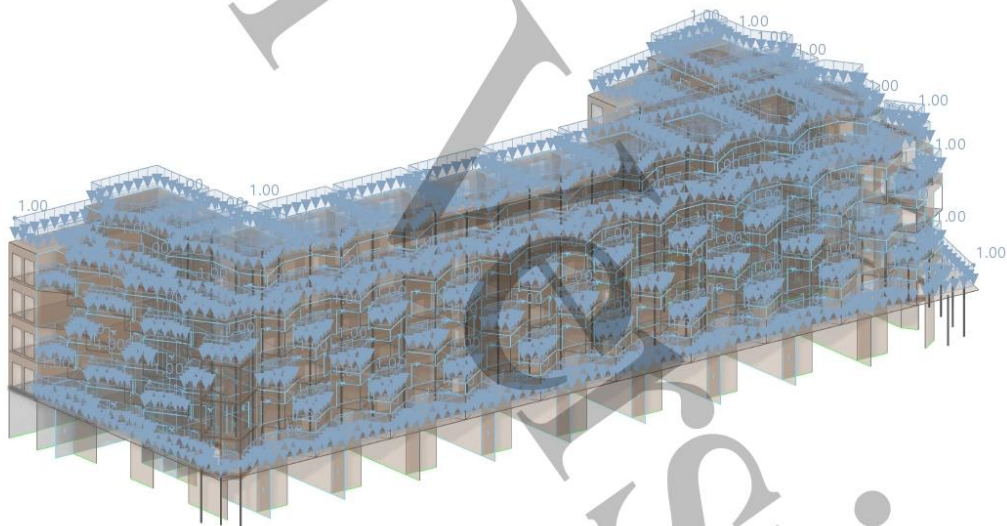



Monika Spajić
Jarunska ulica 2, 10000 Zagreb



Model:
DIPLOMSKI_03_09_2024
model

Date 10.9.2024 Page 18/39
Sheet 1

LOADS

4.4 LC11 - Vjetar pritiskajući

4.4.1 **SURFACE LOADS** **LC11: Vjetar pritiskajući** Qw

Load No.	Surfaces No.	Load Type	Load Distribution	Coord. System	Load Direction	Symbol	Parameters Value	Unit
1	85,91,92,95	Force	Uniform	1	Z _A	p	-0.53	kN/m ²
2	83,97,669,745-747	Force	Uniform	1	Z _A	p	-0.23	kN/m ²
3	101,102,104,107,11 3,116,122,127,129,1 32,138,139,143,145, 146,148,150-152,15 6,158,748-758,776- 783	Force	Uniform	1	Z _A	p	0.30	kN/m ²
4	417	Force	Uniform	1	X _A	p	0.65	kN/m ²
5	512	Force	Linear in Z	5	U _A	n ₁ p ₁ r ₂ p ₂	2287 0.65 3257 0.65	kN/m ² kN/m ² kN/m ² kN/m ²
6	469	Force	Linear in Z	5	U _A	n ₁ p ₁ r ₂ p ₂	2289 0.65 1418 0.65	kN/m ² kN/m ² kN/m ² kN/m ²
7	266	Force	Linear in Z	5	U _A	n ₁ p ₁ r ₂ p ₂	2289 0.65 1418 0.65	kN/m ² kN/m ² kN/m ² kN/m ²
8	67,71,186,192,419,4 22,471,473,658	Force	Linear in Z	5	U _A	n ₁ p ₁ r ₂ p ₂	2289 0.65 1418 0.65	kN/m ² kN/m ² kN/m ² kN/m ²
9	468	Force	Linear in Z	5	V _A	n ₁ p ₁ r ₂ p ₂	2289 0.65 1418 0.65	kN/m ² kN/m ² kN/m ² kN/m ²
10	68,70,185,191,420,4 21,470,472,657	Force	Linear in Z	5	V _A	n ₁ p ₁ r ₂ p ₂	2289 0.65 1418 0.65	kN/m ² kN/m ² kN/m ² kN/m ²
11	14,60,72,179,267,27 4,280,347,348,465,5 15,568,569,606,607	Force	Uniform	1	X _A	p	0.65	kN/m ²
12	49,51,135,264,290,2 98,316,341,366,461, 530,533,534,544,56 1-563,608,609,637, 725,732,737	Force	Uniform	1	X _A	p	0.12	kN/m ²
13	511	Force	Linear in Z	5	V _A	n ₁ p ₁ r ₂ p ₂	1606 0.12 2436 0.12	kN/m ² kN/m ² kN/m ² kN/m ²
14	130,133,222,225,22 8,265,457,459,491,4 92,494	Force	Linear in Z	5	V _A	n ₁ p ₁ r ₂ p ₂	1606 0.12 2436 0.12	kN/m ² kN/m ² kN/m ² kN/m ²
15	497	Force	Linear in Z	5	U _A	n ₁ p ₁ r ₂ p ₂	2655 0.12 2663 0.12	kN/m ² kN/m ² kN/m ² kN/m ²
16	131,134,226,233,35 7,358,458,460,493,5 70,571	Force	Linear in Z	5	U _A	n ₁ p ₁ r ₂ p ₂	2655 0.12 2663 0.12	kN/m ² kN/m ² kN/m ² kN/m ²



Monika Spajić
Jarunska ulica 2, 10000 Zagreb



Model:
DIPLOMSKI_03_09_2024
model

Date 10.9.2024 Page 19/39
Sheet 1

LOADS

4.4.1

SURFACE LOADS

LC11: Vjetar pritiskajući Qw

Load No.	Surfaces No.	Load Type	Load Distribution	Coord. System	Load Direction	Symbol	Parameters Value	Unit
17	3, 11,153,155,159,161, 163,165,166,363,364,382-386,391,393,395	Force	Uniform	1	Z _A	p	0.30	kN/m ²
18	262,268,269	Force	Uniform	1	X _A	p	0.65	kN/m ²
19	425	Force	Linear in Z	5	V _F	p ₁ p ₂	2305 3046	0.53 0.53 kN/m ²
20	74	Force	Linear in Z	5	V _F	p ₁ p ₂	2309 1758	0.53 0.53 kN/m ²
21	76,106,109,112,195, 198,201,204,426,442,444,446,475,477,479,480	Force	Linear in Z	5	V _F	p ₁ p ₂	2309 1758	0.23 0.23 kN/m ²
22	115,118,121,124,210,216,219,448,450,452,454,482,484,486, 488,490,799,801	Force	Linear in Z	5	V _F	p ₁ p ₂	2309 1758	0.23 0.23 kN/m ²
23	427	Force	Linear in Z	5	U _F	p ₁ p ₂	2315 3102	-0.23 -0.23 kN/m ²
24	193,474	Force	Linear in Z	5	U _F	p ₁ p ₂	2315 3102	-0.53 -0.53 kN/m ²
25	77,105,108,197,200, 427,441,443,476,478,700,703	Force	Linear in Z	5	U _F	p ₁ p ₂	2315 3102	-0.23 -0.23 kN/m ²
26	111,114,117,120,123, 126,206,209,212,215,218,445,447,451,453,481,483,485,487, 489,603,604,706,709,712,715,718,721	Force	Linear in Z	5	U _F	p ₁ p ₂	2315 3102	-0.12 -0.12 kN/m ²
27	697	Force	Linear in Z	5	U _F	p ₁ p ₂	2315 3102	-0.53 -0.53 kN/m ²
28	698	Force	Linear in Z	5	V _F	p ₁ p ₂	2315 3102	0.53 0.53 kN/m ²
29	81,701,704,707,710, 713,716,722	Force	Linear in Z	5	V _F	p ₁ p ₂	2315 3102	0.23 0.23 kN/m ²
30	699	Force	Uniform	1	Y _A	p	0.29	kN/m ²
31	125,281-284,286-288	Force	Uniform	1	Y _A	p	0.29	kN/m ²





Monika Spajić
Jarunska ulica 2, 10000 Zagreb



Model:
DIPLOMSKI_03_09_2024
model

Date 10.9.2024 Page 20/39
Sheet 1

LOADS

4.4.1

SURFACE LOADS

LC11: Vjetar pritiskajući Qw

Load No.	Surfaces No.	Load Type	Load Distribution	Coord. System	Load Direction	Symbol	Parameters Value	Unit
32	9,324,327,329-335, 455,510,521-524,52 6-529,549,551-558, 702,705,708,711,71 4,717,720 4,	Force	Uniform	1	Y _A	p	-0.53	kN/m ²
33	61,180,418,466,682 17,690,691,793	Force	Uniform	1	X _A	p	0.65	kN/m ²
34	313,620,621,672-67 4	Force	Uniform	1	Y _A	p	-0.29	kN/m ²
35	689,695,726,743,74 4,804	Force	Uniform	1	Y _A	p	-0.29	kN/m ²
36	207,272,318,506,54 3,547,550,572,615- 619,628,675-681,68 5,696,719,733,738- 742	Force	Uniform	1	Y _A	p	-0.12	kN/m ²
37	53,62,276,277,516,5 17	Force	Uniform	1	Y _A	p	-0.12	kN/m ²
38	21,27-32,34,44	Force	Uniform	1	Y _A	p	0.29	kN/m ²
39	2, 5,8,78,93,181,278,4 28,438,467,518,566, 567,605,622,686,69 3	Force	Uniform	1	X _A	p	0.12	kN/m ²
40		Force	Uniform	1	X _A	p	-0.65	kN/m ²
41	39,57,75,99,270,300 ,305,307,416,440,53 6,539,540,611,613,7 29,735	Force	Uniform	1	X _A	p	0.65	kN/m ²



Monika Spajić
Jarunska ulica 2, 10000 Zagreb



Model:
DIPLOMSKI_03_09_2024
model

Date 10.9.2024 Page 21/39
Sheet 1

MODEL

4.4.2 LC11: LOADING, IN AXONOMETRIC DIRECTION

LC11 - Vjetar pritiskajući
Loads [kN/m²]

In Axonometric Direction

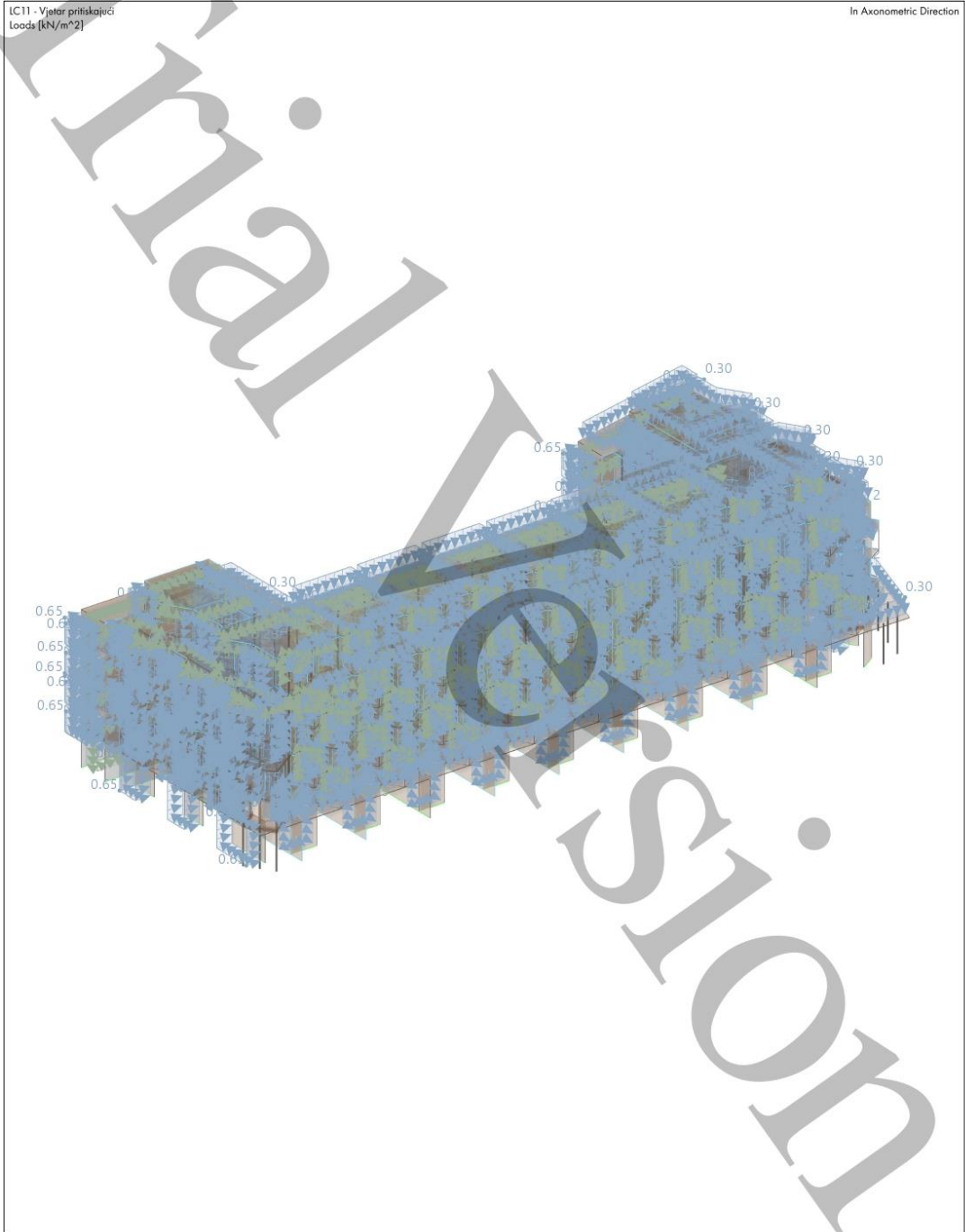



Monika Spajić
Jarunska ulica 2, 10000 Zagreb



Model:
DIPLOMSKI_03_09_2024
model

Date 10.9.2024 Page 22/39
Sheet 1

LOADS

4.5 LC12 - Vjetar odličući

4.5.1

SURFACE LOADS

LC12: Vjetar odličući

Gw

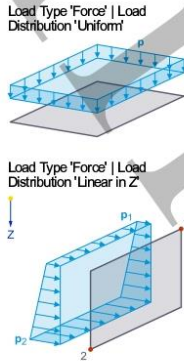

Load No.	Surfaces No.	Load Type	Load Distribution	Coord. System	Load Direction	Symbol	Parameters Value	Unit
1	92,97,102,107,116,127,132,139,146,158,223,231,232,578	Force	Uniform	1	Z _A	p	-0.82	kN/m ²
2	96,156,669,745-758,776-783	Force	Uniform	1	Z _A	p	-0.53	kN/m ²
3	475	Force	Uniform	5	V _P	p	-0.35	kN/m ²
4	74,76,81,106,109,112,115,118,121,124,195,198,210,213,216,219,265,425,426,442,444,446,448,450,452,454,477,479,480,482,484,486,488,490,511,698,701,704,707,710,713,716,722,786,799	Force	Uniform	5	V _P	p	-0.35	kN/m ²
6	77,105,108,111,114,117,120,123,126,193,197,200,206,209,212,215,218,427,441,443,445,447,449,451,453,456,474,476,478,481,483,485,487,489,603,604,700,703,706,709,712,715,718,721	Force	Uniform	5	U _P	p	0.35	kN/m ²
7	125,258,281-284,286-289,324,327,329-334,455,510,521-524,526-529,549,551-558,699,702,705,708,711,714,717,720,797	Force	Uniform	1	Y _A	p	-0.35	kN/m ²
8	207,272,318,506,543,547,550,572,615-621,628,672,673,680,681,685,689,695,698,719,726,733,738-744,804	Force	Uniform	1	Y _A	p	-0.41	kN/m ²
9	313,674-679	Force	Uniform	1	Y _A	p	-0.41	kN/m ²
10	469	Force	Linear in Z	5	U _P	n ₁ p ₁ n ₂ p ₂	2574 0.59 2580 0.59	kN/m ²
11	67,186,266,419,471,512,658,684,688	Force	Linear in Z	5	U _P	n ₁ p ₁ n ₂ p ₂	2574 0.59 2580 0.59	kN/m ²
12	71,192,422,473,697	Force	Linear in Z	5	U _P	n ₁ p ₁ n ₂ p ₂	2574 0.82 2580 0.82	kN/m ²
13	472	Force	Linear in Z	5	V _P	n ₁ p ₁ n ₂ p ₂	2574 0.82 2580 0.82	kN/m ²
14	191,424	Force	Linear in Z	5	V _P	n ₁ p ₁ n ₂ p ₂	2574 0.82 2580 0.82	kN/m ²
15	68,70,185,420,421,468,470,657,683,687	Force	Linear in Z	5	V _P	n ₁ p ₁ n ₂ p ₂	2574 0.53 2580 0.53	kN/m ²
16	14,17,60,72,179,267	Force	Uniform	1	X _A	p	0.59	kN/m ²





Monika Spajić
Jarunska ulica 2, 10000 Zagreb



Model:
DIPLOMSKI_03_09_2024
model

Date 10.9.2024 Page 23/39
Sheet 1

LOADS

4.5.1

SURFACE LOADS

LC12: Vjetar odižući Qw

Load No.	Surfaces No.	Load Type	Load Distribution	Coord. System	Load Direction	Symbol	Parameters Value	Unit
17	,274,280,347,348,41 7,465,515,568,569,6 06,607,690,691,793 130,133,225,228,45 7,459,492,494,730	Force	Linear in Z	5	V _F	n ₁	2438	
							p ₁	0.59 kN/m ²
							r ₂	3180
							p ₂	0.59 kN/m ²
18	222,491,723	Force	Linear in Z	5	V _F	n ₁	2438	
							p ₁	0.82 kN/m ²
							r ₂	3180
							p ₂	0.82 kN/m ²
19	570	Force	Linear in Z	5	U _F	n ₁	2438	
							p ₁	0.82 kN/m ²
							r ₂	3180
							p ₂	0.82 kN/m ²
20	357,358,571,724	Force	Linear in Z	5	U _F	n ₁	2438	
							p ₁	0.82 kN/m ²
							r ₂	3180
							p ₂	0.82 kN/m ²
21	131,134,226,233,46 0,493,497,731	Force	Linear in Z	5	U _F	n ₁	2438	
							p ₁	0.59 kN/m ²
							r ₂	3180
							p ₂	0.59 kN/m ²
22	49,51,135,230,264,2 90,298,316,341,461, 496,530,531,533,53 4,544,561-563,608, 609,637,725,727,73 2,737,803	Force	Uniform	1	X _F	p	0.59	kN/m ²
23	363,364	Force	Uniform	1	Z _F	p	-0.53	kN/m ²
							24	4, 53,61,62,180,276,27 7,418,466,516,517,6 82
25	39,57,75,99,270,300 ,305,307,416,440,53 6,539,540,611,613,7 29,735,736	Force	Uniform	1	X _A	p		
							26	2, 5,8,78,93,181,278,4 28,438,467,518,566, 567,605,622,686,69 3
27		Force	Uniform	1	X _A	p		



Monika Spajić
Jarunska ulica 2, 10000 Zagreb



Model:
DIPLOMSKI_03_09_2024
model

Date 10.9.2024 Page 24/39
Sheet 1

MODEL

4.5.2 LC12: LOADING, IN AXONOMETRIC DIRECTION

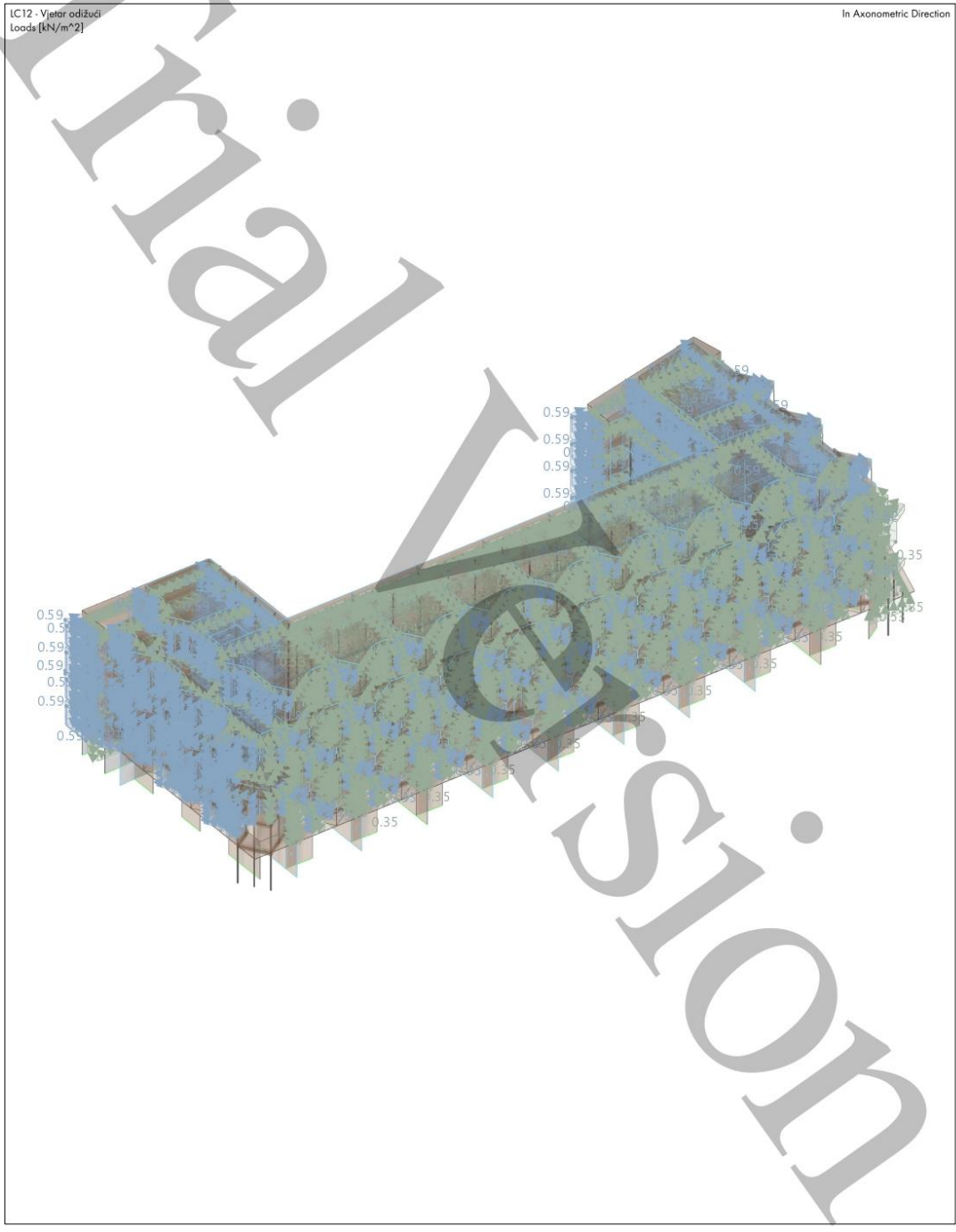



Monika Spajić
Jarunska ulica 2, 10000 Zagreb



Model:
DIPLOMSKI_03_09_2024
model

Date 10.9.2024 Page 25/39
Sheet 1

MODEL

5 Dynamic Loads

5.1 RESPONSE SPECTRA

RS No.	Definition Type	Comment
1	According to Standard - EN 1998-1 CEN 2013-05	
2	According to Standard - EN 1998-1 CEN 2013-05	

5.1.1 RESPONSE SPECTRA - PARAMETERS

RS No.	Parameter	Symbol	Value	Unit	Reference
1	According to Standard - EN 1998-1 CEN 2013-05				
	Type of spectrum		Design Spectrum		
	Spectrum shape		Horizontal		
	Spectrum direction				
	Spectrum type		1		
	Ground type		A		
	Earthquake action				
	Reference peak ground acceleration	a_{gR}	0.24	m/s ²	
	Importance class		II		
	Importance factor Class II	γ_I	1.000	--	4.2.5(5)P
	Design ground acceleration Horizontal	a_g	0.24	m/s ²	
	Factors				
	Behavior factor	q	1.500	--	
	Limit value	β	0.200	--	
	Ground type parameters				
	Soil factor Ground type A	S	1.000	--	3.2.2.2(2)P, Tab. 3.2
	Control period Ground type A	T_B	0.150	s	3.2.2.2(2)P, Tab. 3.2
	Control period Ground type A	T_C	0.400	s	3.2.2.2(2)P, Tab. 3.2
	Control period Ground type A	T_D	2.000	s	3.2.2.2(2)P, Tab. 3.2
	Maximum period	T_{max}	4.000	s	
2	According to Standard - EN 1998-1 CEN 2013-05				
	Type of spectrum		Design Spectrum		
	Spectrum shape		Horizontal		
	Spectrum direction				
	Spectrum type		1		
	Ground type		A		
	Earthquake action				
	Reference peak ground acceleration	a_{gR}	0.24	m/s ²	
	Importance class		II		
	Importance factor Class II	γ_I	1.000	--	4.2.5(5)P
	Design ground acceleration Horizontal	a_g	0.24	m/s ²	
	Factors				
	Behavior factor	q	1.500	--	
	Limit value	β	0.200	--	
	Ground type parameters				
	Soil factor Ground type A	S	1.000	--	3.2.2.2(2)P, Tab. 3.2
	Control period Ground type A	T_B	0.150	s	3.2.2.2(2)P, Tab. 3.2
	Control period Ground type A	T_C	0.400	s	3.2.2.2(2)P, Tab. 3.2
	Control period Ground type A	T_D	2.000	s	3.2.2.2(2)P, Tab. 3.2
	Maximum period	T_{max}	4.000	s	

6 Static Analysis Results



Monika Spajić
Jarunska ulica 2, 10000 Zagreb



Model:
DIPLOMSKI_03_09_2024
model

Date 10.9.2024 Page 26/39
Sheet 1

MODEL

6.1 CO10: BASIC INTERNAL FORCES N_x IN AXONOMETRIC DIRECTION

Static Analysis

CO10 - 1.35 * LC1 + 1.35 * LC2 + 1.50 * LC3 + 0.75 * LC4 + 0.90 * LC12
Static Analysis
Axial Forces n_x [kN/m]

In Axonometric Direction

Surfaces Internal Forces Basic Internal Forces n_x [kN/m]	Percentage
49860.500	0.00 %
42787.300	0.00 %
35714.100	0.00 %
28640.900	0.00 %
21567.700	0.00 %
14494.500	0.00 %
7421.340	0.00 %
348.139	100.00 %
-6725.060	0.00 %
-13798.300	0.00 %
-20871.500	0.00 %
-27944.700	0.00 %

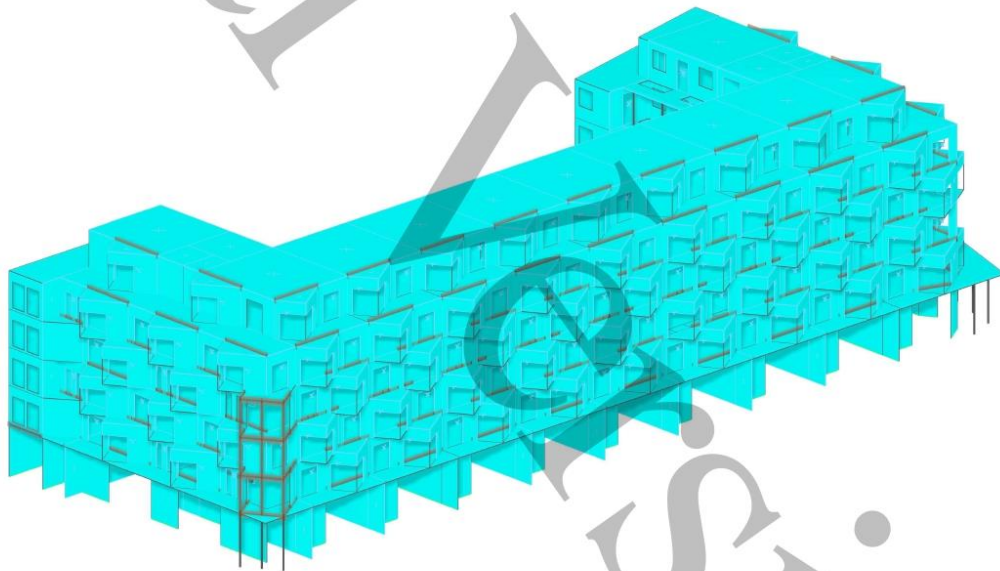

max n_x : 49860.500 | min n_x : -27944.700 kN/m



Monika Spajić
Jarunska ulica 2, 10000 Zagreb



Model:
DIPLOMSKI_03_09_2024
model

Date 10.9.2024 Page 27/39
Sheet 1

MODEL

6.2 CO10: BASIC INTERNAL FORCES M_x IN AXONOMETRIC DIRECTION

Static Analysis

CO10 - 1.35 * LC1 + 1.35 * LC2 + 1.50 * LC3 + 0.75 * LC4 + 0.90 * LC12
Static Analysis
Moments m_x [kNm/m]

In Axonometric Direction

Surfaces Internal Forces	Basic Internal Forces	m_x [kNm/m]	%
		242.382	0.00 %
		208.561	0.00 %
		174.740	0.00 %
		140.919	0.00 %
		107.099	0.00 %
		73.278	0.00 %
		39.457	0.00 %
		5.636	13.45 %
		-28.185	86.47 %
		-62.006	0.08 %
		-95.827	0.00 %
		-129.648	0.00 %

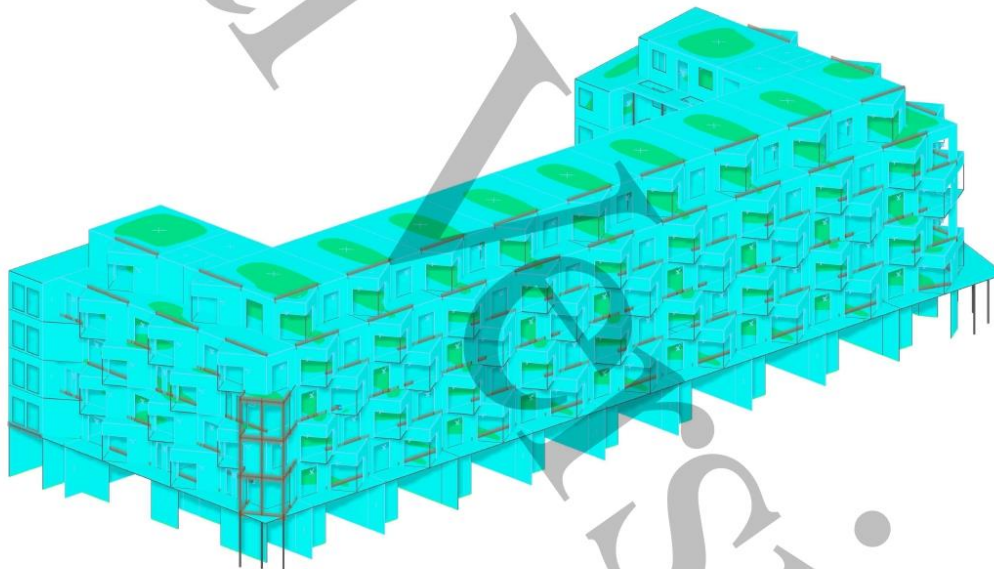

max m_x : 242.382 | min m_x : -129.648 kNm/m



Monika Spajić
Jarunska ulica 2, 10000 Zagreb



Model:
DIPLOMSKI_03_09_2024
model

Date 10.9.2024 Page 28/39
Sheet 1

MODEL

6.3 **CO10: BASIC INTERNAL FORCES M_y , IN AXONOMETRIC DIRECTION**

Static Analysis

CO10 - 1.35 * LC1 + 1.35 * LC2 + 1.50 * LC3 + 0.75 * LC4 + 0.90 * LC12
Static Analysis
Moments m_y [kNm/m]

In Axonometric Direction

Surfaces Internal Forces	Basic Internal Forces	
m_y [kNm/m]		
69.879	0.00 %	
40.006	1.22 %	
10.132	98.69 %	
-19.742	0.09 %	
-49.616	0.00 %	
-79.490	0.00 %	
-109.364	0.00 %	
-139.237	0.00 %	
-169.111	0.00 %	
-198.985	0.00 %	
-228.859	0.00 %	
-258.733	0.00 %	

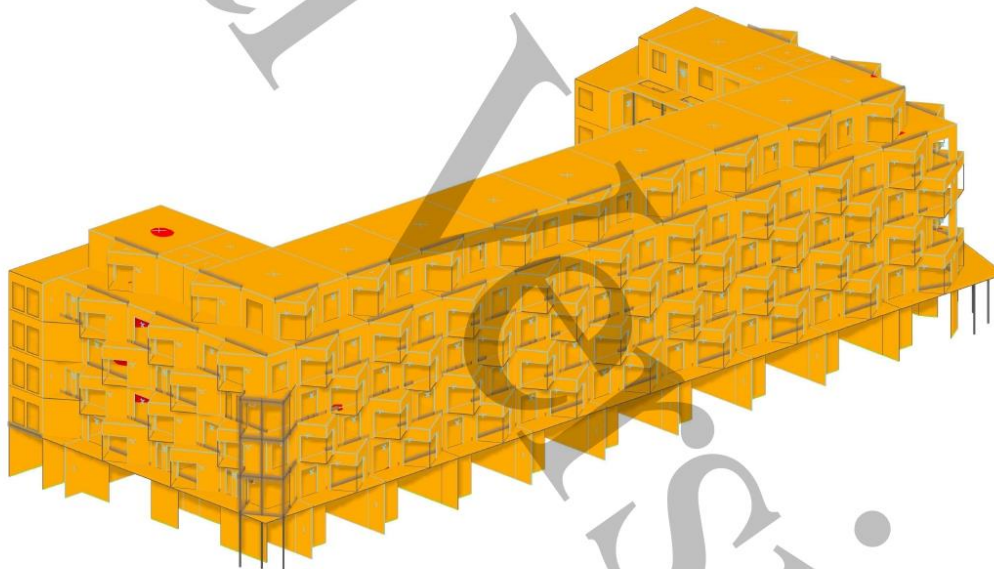

max m_y : 69.879 | min m_y : -258.733 kNm/m





Monika Spajić
Jarunska ulica 2, 10000 Zagreb



Model:
DIPLOMSKI_03_09_2024
model

Date 10.9.2024 Page 29/39
Sheet 1

MODEL

6.4 CO10: BASIC INTERNAL FORCES N_y , IN AXONOMETRIC DIRECTION

Static Analysis

CO10 - 1.35 * LC1 + 1.35 * LC2 + 1.50 * LC3 + 0.75 * LC4 + 0.90 * LC12
Static Analysis
Axial Forces n_y [kN/m]

In Axonometric Direction

Surfaces Internal Forces Basic Internal Forces n_y [kN/m]	Color	Percentage
31322.400	Red	0.00 %
27351.300	Red-Orange	0.00 %
23380.100	Orange	0.00 %
19409.000	Yellow-Orange	0.00 %
15437.800	Yellow	0.00 %
11466.600	Yellow-Green	0.00 %
7495.490	Green	0.00 %
3524.340	Light Green	0.00 %
-446.821	Cyan	100.00 %
-4417.980	Blue-Cyan	0.00 %
-8389.130	Blue	0.00 %
-12360.300	Dark Blue	0.00 %

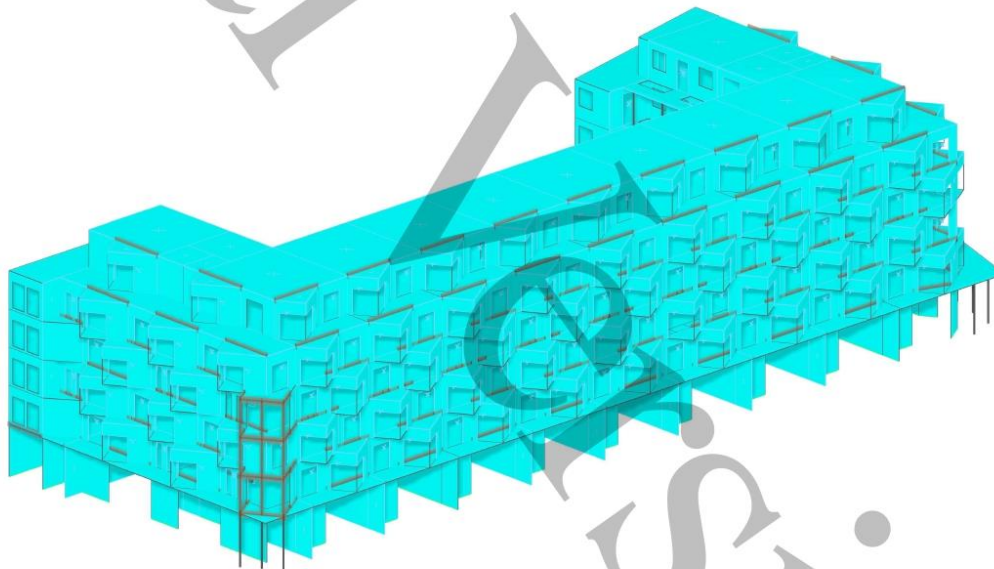

max n_y : 31322.400 | min n_y : -12360.300 kN/m



Monika Spajić
Jarunska ulica 2, 10000 Zagreb



Model:
DIPLOMSKI_03_09_2024
model

Date 10.9.2024 Page 30/39
Sheet 1

MODEL

6.5 CO80: GLOBAL DEFORMATIONS [u], IN AXONOMETRIC DIRECTION

Static Analysis

CO80 - LC1 + LC2 + 0.70 * LC3 + 0.50 * LC4 + LC12
Static Analysis
Displacements [u] [mm]

In Axonometric Direction

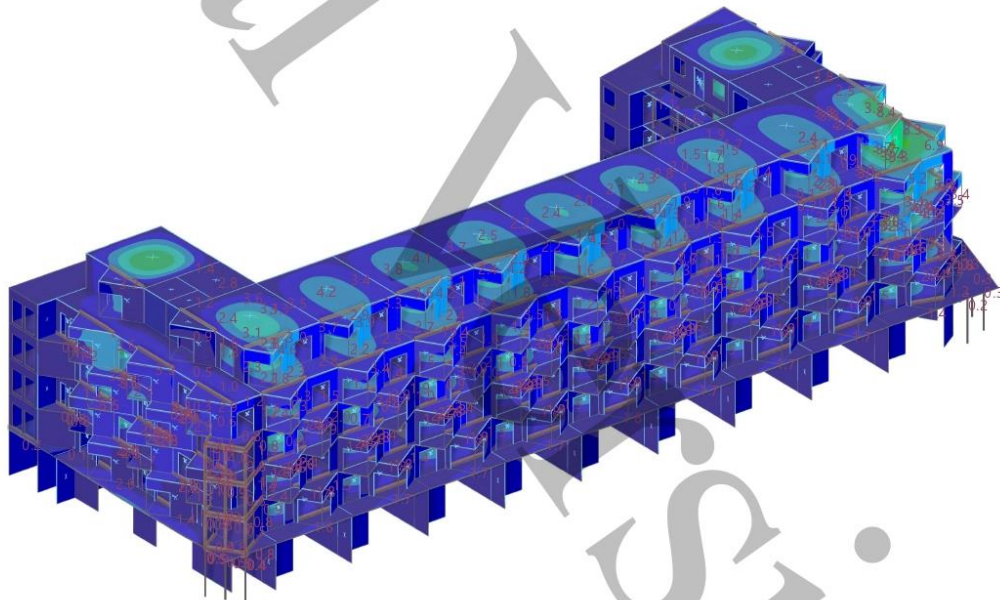
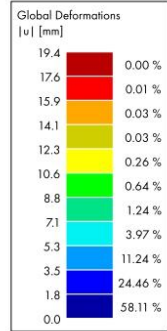

max [u] : 19.4 | min [u] : 0.0 mm



Monika Spajić
Jarunska ulica 2, 10000 Zagreb



Model:
DIPLOMSKI_03_09_2024
model

Date 10.9.2024 Page 31/39
Sheet 1

MODEL

6.6 **RC4: ENVELOPE VALUES - MAX AND MIN VALUES, FORCES v_z , IN AXONOMETRIC DIRECTION** Static Analysis

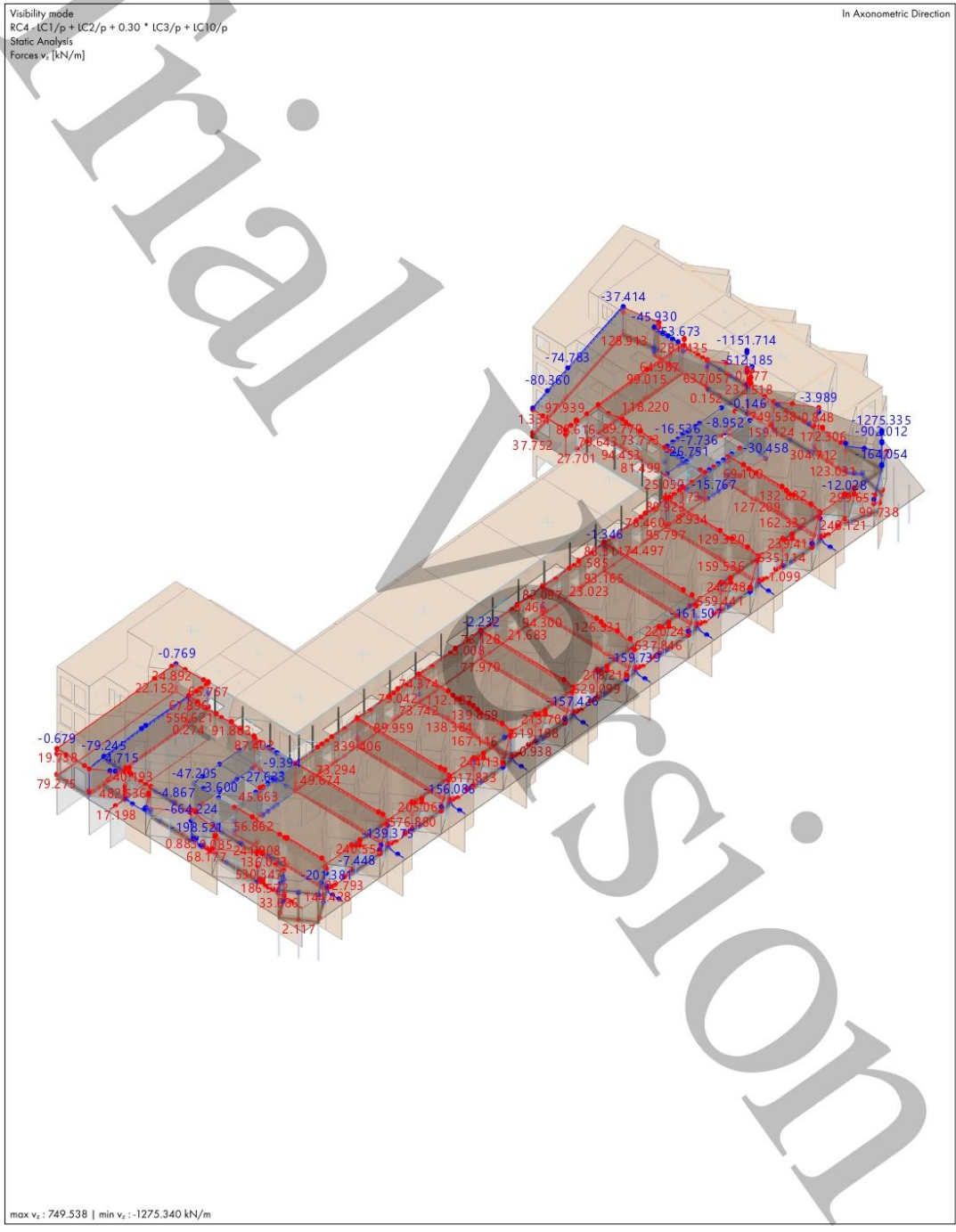



Monika Spajić
Jarunska ulica 2, 10000 Zagreb



Model:
DIPLOMSKI_03_09_2024
model

Date 10.9.2024 Page 32/39
Sheet 1

MODEL

6.7 RC4: ENVELOPE VALUES - MAX AND MIN VALUES, FORCES N, IN AXONOMETRIC DIRECTION

Static Analysis

Visibility mode
RC4 - IC1/p + IC2/p + 0.30 * IC3/p + IC10/p
Static Analysis
Forces n [kN/m]

In Axonometric Direction

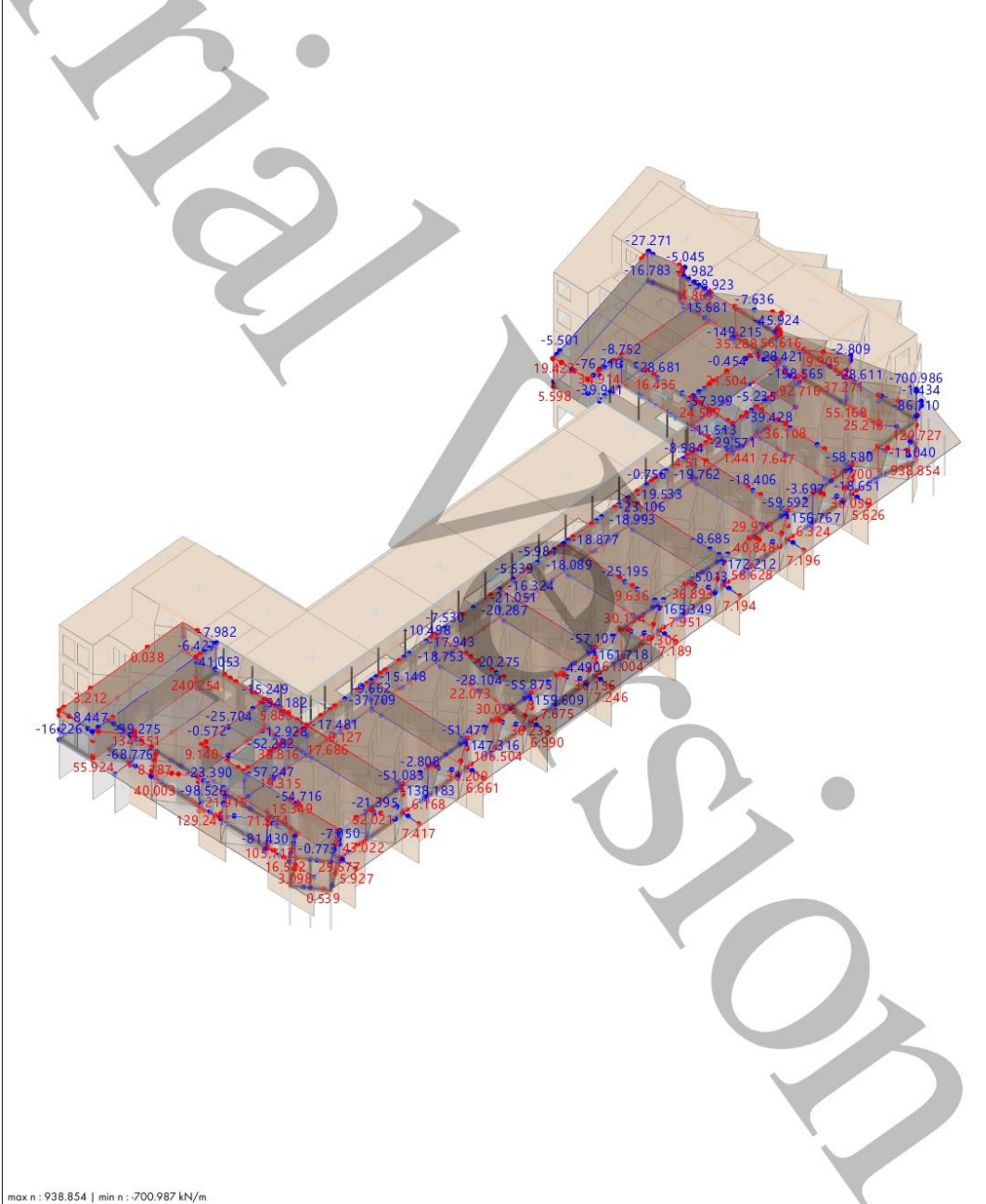

Monika Spajić
Jarunska ulica 2, 10000 Zagreb



Model:
DIPLOMSKI_03_09_2024
model

Date 10.9.2024 Page 33/39
Sheet 1

MODEL

6.8 RC4: ENVELOPE VALUES - MAX AND MIN VALUES, FORCES V_y , IN AXONOMETRIC DIRECTION

Static Analysis

Visibility mode
RC4 - IC1/p + IC2/p + 0.30 * IC3/p + IC10/p
Static Analysis
Forces v_y [kN/m]

In Axonometric Direction

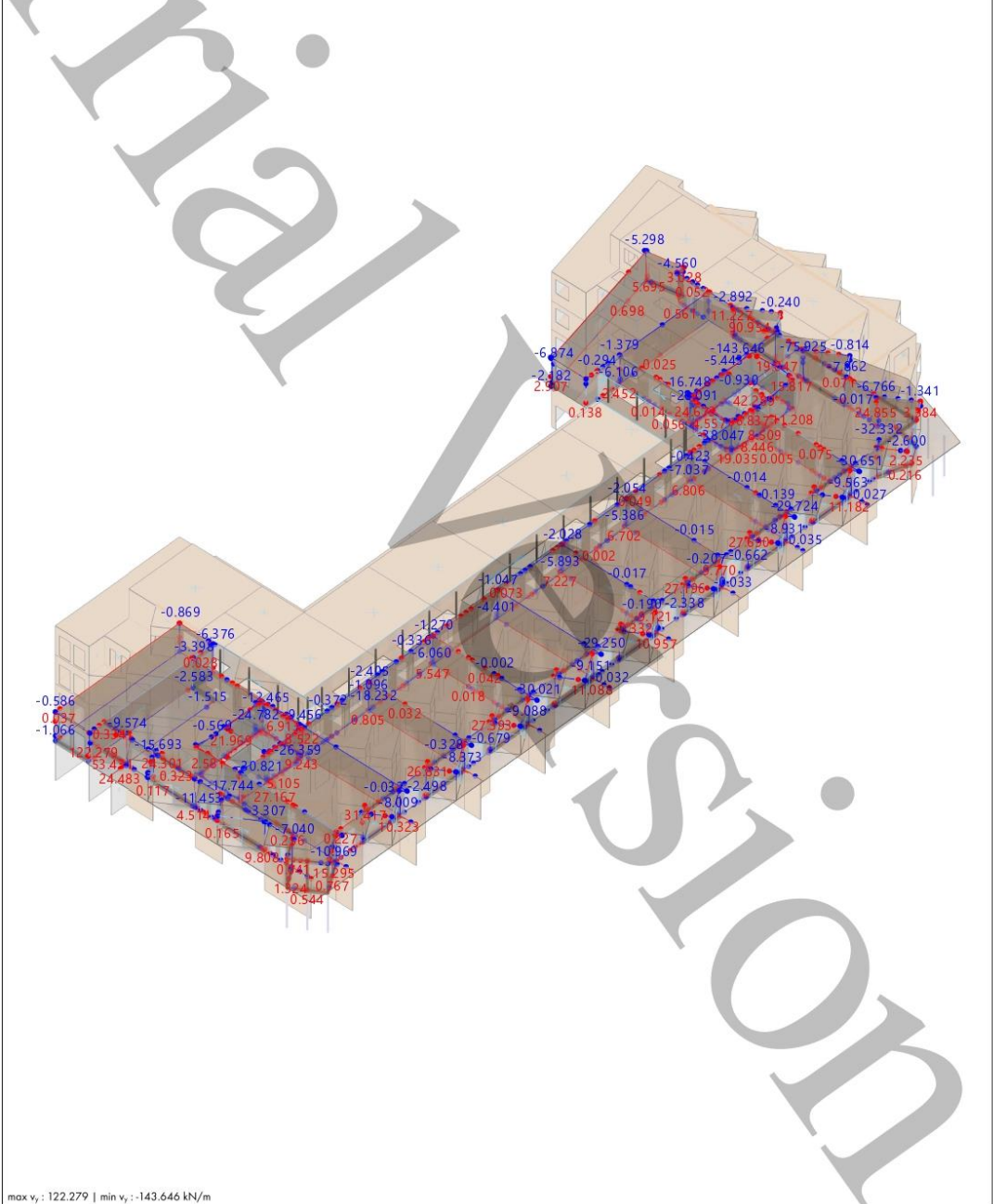



Monika Spajić
Jarunska ulica 2, 10000 Zagreb



Model:
DIPLOMSKI_03_09_2024
model

Date: 10.9.2024 Page: 34/39
Sheet: 1

MODEL

7 Modal Analysis Results

7.1 NATURAL FREQUENCIES

Modal Analysis

Mode No.	Eigenvalue λ [1/s ²]	Angular Frequency ω [rad/s]	Natural Frequency f [Hz]	Natural Period T [s]
1	989.615	31.458	5.007	0.200
2	1196.244	34.587	5.505	0.182
3	1401.971	37.443	5.959	0.168
4	1612.895	40.161	6.392	0.156
5	1631.275	40.389	6.428	0.156
6	1995.460	44.671	7.110	0.141
7	2136.357	46.221	7.356	0.136
8	2196.768	46.870	7.460	0.134
9	2209.125	47.001	7.480	0.134
10	2216.327	47.078	7.493	0.133
11	2376.699	48.751	7.759	0.129
12	2872.780	53.598	8.530	0.117
13	2940.677	54.228	8.631	0.116
14	2979.164	54.582	8.687	0.115
15	2989.215	54.674	8.702	0.115
16	3013.283	54.893	8.737	0.114
17	3079.868	55.497	8.833	0.113
18	3101.487	55.691	8.863	0.113
19	3111.952	55.785	8.878	0.113
20	3115.814	55.819	8.884	0.113

7.2 EFFECTIVE MODAL MASSES

Modal Analysis

Mode No.	Modal Mass M_i [kg]	Transl. Eff. Modal Mass [kg]			Rotat. Eff. Modal Mass [kgm ²]			Transl. Eff. Modal Mass Factor [-]			Rotat. Eff. Modal Mass Factor [-]		
		m_{mx}	m_{my}	m_{mz}	$m_{\theta x}$	$m_{\theta y}$	$m_{\theta z}$	f_{mx}	f_{my}	f_{mz}	$f_{\theta x}$	$f_{\theta y}$	$f_{\theta z}$
1	519387.3	707.8	1493310.0	1096.8	19337300.00	111325.00	1.68e+08	0.000	0.609	0.000	0.083	0.000	0.105
2	451201.7	731660.0	90554.2	148.8	1633450.00	5392700.00	5.71e+08	0.299	0.037	0.000	0.008	0.004	0.356
3	349717.2	740738.0	74261.1	190.5	1596830.00	12857500.00	2.96e+08	0.302	0.030	0.000	0.008	0.008	0.186
4	15.0	7.1	10.1	0.0	2768.82	3796.16	712.45	0.000	0.000	0.000	0.000	0.000	0.000
5	15.0	5.8	6.7	0.1	1577.86	2044.66	1773.52	0.000	0.000	0.000	0.000	0.000	0.000
6	763.2	0.0	100.3	3670.2	16.24	174960.00	18302.10	0.000	0.000	0.001	0.000	0.000	0.000
7	807.2	23.3	164.6	4175.6	287.35	1109.09	14440.60	0.000	0.000	0.002	0.000	0.000	0.000
8	996.0	3.7	81.6	1502.9	97.31	30938.00	12495.60	0.000	0.000	0.001	0.000	0.000	0.000
9	929.2	0.0	1.4	15.7	5.47	8188.49	252.70	0.000	0.000	0.000	0.000	0.000	0.000
10	831.0	0.0	1.9	367.9	23.58	9155.78	268.39	0.000	0.000	0.000	0.000	0.000	0.000
11	214711.5	5943.6	69614.0	28.9	715641.00	198551.00	15559100.00	0.002	0.028	0.000	0.003	0.000	0.010
12	11236.9	3.9	2.2	167.8	5881.81	90921.90	206.43	0.000	0.000	0.000	0.000	0.000	0.000
13	6839.4	2.1	290.1	24086.4	902697.00	21472400.00	198001.00	0.000	0.000	0.010	0.004	0.014	0.000
14	4133.0	34.8	361.2	29505.0	700241.00	24873500.00	190070.00	0.000	0.000	0.012	0.003	0.016	0.000
15	4502.5	0.4	5.2	106.2	2173.37	89269.80	3923.52	0.000	0.000	0.000	0.000	0.000	0.000
16	11793.6	597.5	606.4	16023.4	1068290.00	17473900.00	300791.00	0.000	0.000	0.007	0.005	0.011	0.000
17	8424.7	0.0	26.5	6727.4	256884.00	5807710.00	13850.80	0.000	0.000	0.003	0.001	0.004	0.000
18	4707.8	2.9	29.8	53.9	2503.85	51193.50	9777.14	0.000	0.000	0.000	0.000	0.000	0.000
19	1396.14	2.3	65.5	354.1	21102.00	542697.00	56458.10	0.000	0.000	0.000	0.000	0.000	0.000
20	4089.0	0.1	0.0	726.5	28057.90	629708.00	4.35	0.000	0.000	0.000	0.000	0.000	0.000
Σ	1609062.4	1479730.0	1729500.0	88948.2	26275900.00	89520900.00	1.05e+09	0.604	0.706	0.036	0.126	0.059	0.656
Σ_i		2450400.0	2450400.0	2450400.0	2.09e+08	1.52e+09	1.61e+09						
%		60.39 %	70.58 %	3.63 %	12.57 %	5.87 %	65.62 %						

7.3 EFFECTIVE MODAL MASSES - EQUIVALENT MASS PER UNIT LENGTH

Modal Analysis

Mode No.	Modal Mass M_i [kg]
1	519387.3
2	451201.7
3	349717.2
4	15.0
5	15.0
6	763.2
7	807.2
8	996.0
9	929.2
10	831.0
11	214711.5
12	11236.9
13	6839.4
14	4133.0
15	4502.5





Monika Spajić
 Jarunska ulica 2, 10000 Zagreb



Model:
 DIPLOMSKI_03_09_2024
 model

Date 10.9.2024 Page 35/39
 Sheet 1

RESULTS

7.3 EFFECTIVE MODAL MASSES - EQUIVALENT MASS PER UNIT LENGTH

Modal Analysis

Mode No.	Modal Mass M [kg]
16	11793.6
17	8424.7
18	4707.8
19	13961.4
20	4089.0
Σ	1609062.4
ΣM _i	
%	



Monika Spajić
Jarunska ulica 2, 10000 Zagreb



Model:
DIPLOMSKI_03_09_2024
model

Date 10.9.2024 Page 36/39
Sheet 1

MODEL

7.4 LC9: MODE SHAPE |U|, IN AXONOMETRIC DIRECTION

Modal Analysis

LC9 - Potras
Modal Analysis
Mode No. 1 - 5.007 Hz
Normalized Displacements |u|

In Axonometric Direction

Mode Shape u [-]	Percentage
1.00000	4.10 %
0.90909	7.35 %
0.81818	4.01 %
0.72727	8.82 %
0.63636	6.57 %
0.54545	7.60 %
0.45455	6.04 %
0.36364	14.19 %
0.27273	10.36 %
0.18182	17.36 %
0.09091	13.60 %
0.00000	

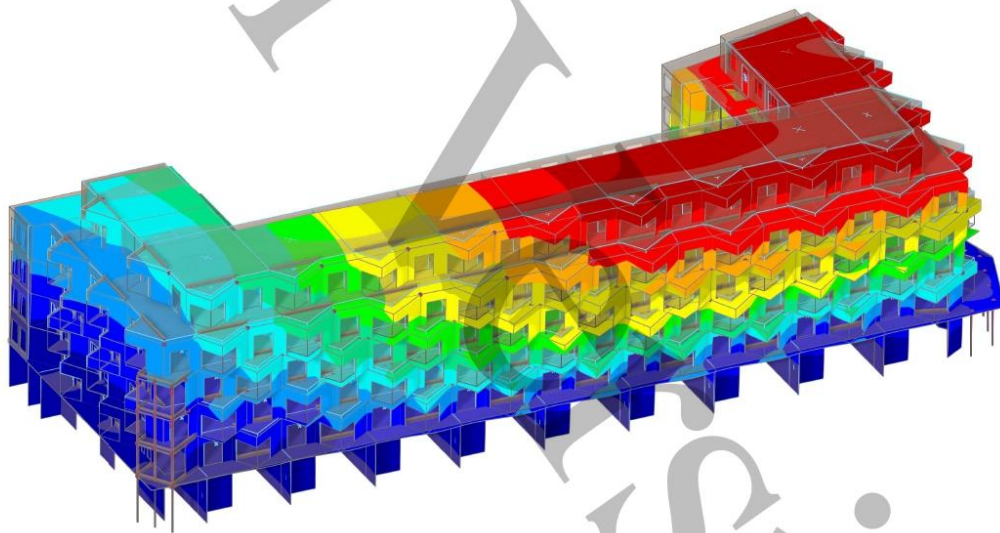

max |u| : 1.00000 | min |u| : 0.00000



Monika Spajić
Jarunska ulica 2, 10000 Zagreb



Model:
DIPLOMSKI_03_09_2024
model

Date 10.9.2024 Page 37/39
Sheet 1

MODEL

7.5 LC9: MODE SHAPE |U|, IN AXONOMETRIC DIRECTION

Modal Analysis

LC9 - Potras
Modal Analysis
Mode No. 2 - 5.505 Hz
Normalized Displacements |u|

In Axonometric Direction

Mode Shape u [-]	Percentage
1.00000	0.64 %
0.90909	2.56 %
0.81818	5.92 %
0.72727	8.95 %
0.63636	10.40 %
0.54545	11.79 %
0.45455	11.27 %
0.36364	11.63 %
0.27273	9.92 %
0.18182	15.17 %
0.09091	11.76 %
0.00000	

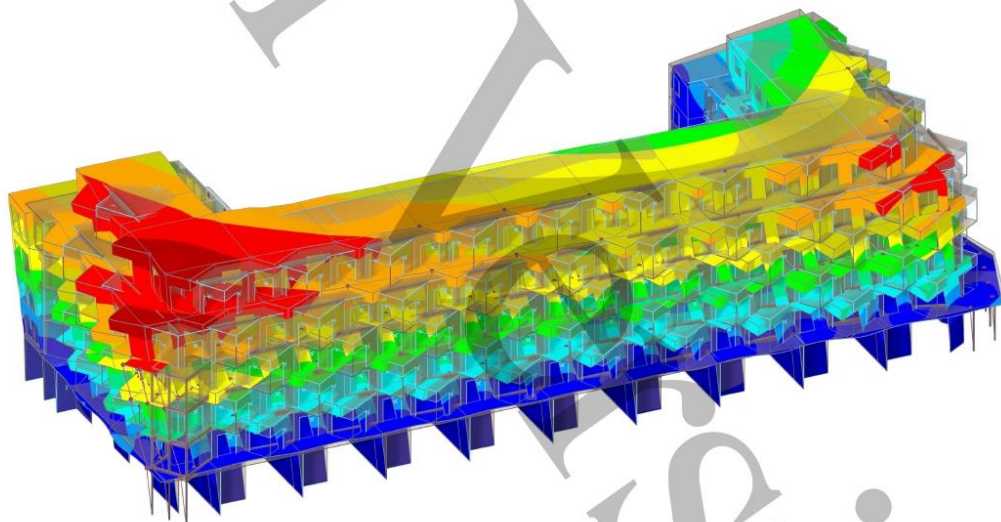

max |u| : 1.00000 | min |u| : 0.00000



Monika Spajić
Jarunska ulica 2, 10000 Zagreb



Model:
DIPLOMSKI_03_09_2024
model

Date 10.9.2024 Page 38/39
Sheet 1

MODEL

7.6 LC9: MODE SHAPE |U|, IN AXONOMETRIC DIRECTION

Modal Analysis

LC9 - Potras
Modal Analysis
Mode No. 3 - 5.959 Hz
Normalized Displacements |u|

In Axonometric Direction

Mode Shape u [-]	Percentage
1.00000	0.00 %
0.90909	1.23 %
0.81818	3.29 %
0.72727	4.32 %
0.63636	9.99 %
0.54545	11.79 %
0.45455	13.04 %
0.36364	14.03 %
0.27273	12.76 %
0.18182	12.13 %
0.09091	17.43 %
0.00000	

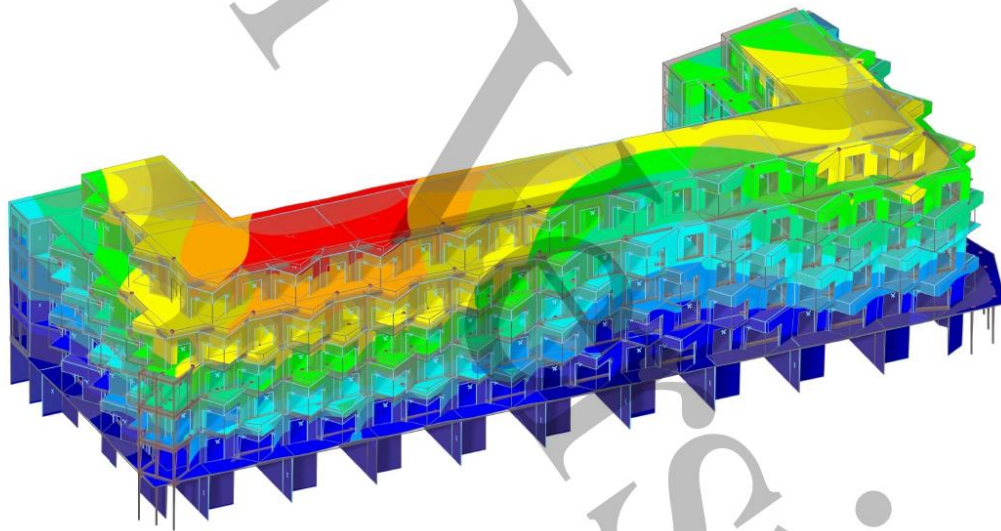

max |u| : 1.00000 | min |u| : 0.00000



Monika Spajić
Jarunska ulica 2, 10000 Zagreb



Model:
DIPLOMSKI_03_09_2024
model

Date 10.9.2024 Page 39/39
Sheet 1

MODEL

7.7 LC9: MODE SHAPE |U|, IN AXONOMETRIC DIRECTION

Modal Analysis

LC9 - Potras
Modal Analysis
Mode No. 4 - 6.392 Hz
Normalized Displacements |u|

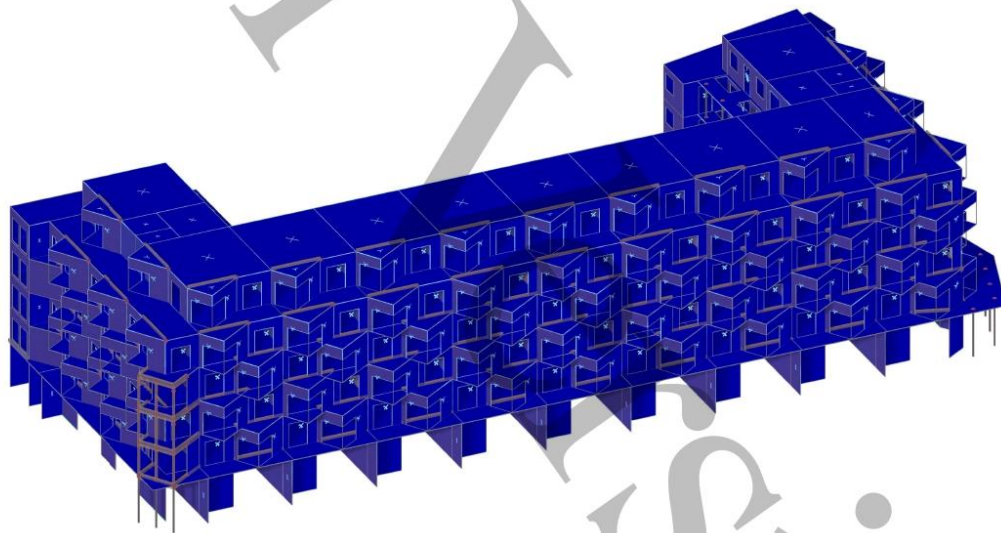
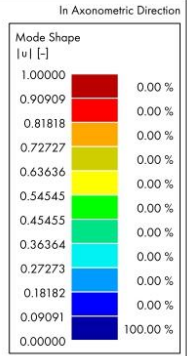

max |u| : 1.00000 | min |u| : 0.00000



3.5. Dimenzioniranje – Dlubal RFEM

3.5.1.1. Dimenzioniranje elemenata (grede i stupovi - GL32h)

Monika Spojić
Jarunska ulica 2, 10000 Zagreb



Model:

DIPLOMSKI_03_09_2024

model

Date 11.9.2024 Page 1/10

Sheet 1

MODEL

CONTENTS

1	Basic Objects	2	2.3	Fire Resistance Configurations	4
1.1	Materials	2	2.3.1	Fire Resistance Configurations - Settings - Members	5
1.2	Sections	2	2.4	Results	5
1.2.1	Sections - Information	2	2.4.1	Design Ratios on Members by Section	5
2	Timber Design	2	2.5	Member No. 96 DS1 CO6 1.251 m Left Side Stress Point No. 7 ST1600.01	7
2.1	Ultimate Configurations	2	2.6	Member No. 220 DS1 CO6 0.000 m Stress Point No. 4 SP3100	9
2.1.1	Ultimate Configurations - Settings - Members	3	2.7	Member No. 312 DS1 CO6 0.044 m Stress Point No. 4 SP2100	10
2.2	Serviceability Configurations	3			
2.2.1	Serviceability Configurations - Settings - Members	4			





Monika Spajić
Jarunska ulica 2, 10000 Zagreb



Model:
DIPLOMSKI_03_09_2024
model

Date 11.9.2024 Page 2/10
Sheet 1

MODEL

1 Basic Objects

1.1 MATERIALS

Legend
 Stiffness modification

Material No.	Material Name	Material Type	Analysis Model	Options
6	Stora Enso (40 mm) Orthotropic Linear Elastic (Surfaces)	Timber	Orthotropic Linear Elastic (Surfaces)	<input checked="" type="checkbox"/>
7	C 35/40 beton	Concrete	Isotropic Linear Elastic	
8	GL32h Isotropic Linear Elastic	Timber	Isotropic Linear Elastic	<input checked="" type="checkbox"/>
9	S355 Isotropic Linear Elastic	Steel	Isotropic Linear Elastic	
10	Stora Enso (30 mm) Orthotropic Linear Elastic (Surfaces)	Timber	Orthotropic Linear Elastic (Surfaces)	<input checked="" type="checkbox"/>
11	Stora Enso (20 mm) Orthotropic Linear Elastic (Surfaces)	Timber	Orthotropic Linear Elastic (Surfaces)	<input checked="" type="checkbox"/>

1.2 SECTIONS

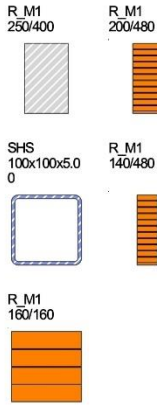

Section No.	Material No.	Section Type	Manufacturing Type	I_x [cm ⁴]	I_y [cm ⁴]	I_z [cm ⁴]	Overall Dimensions	
				A [cm ²]	A_y [cm ²]	A_z [cm ²]	b [mm]	h [mm]
1	7	R_M1 250/400 7 - C 35/40 beton	Parametric - Massive I	127345.16	133333.33	52063.33	250.0	400.0
				1000.00	833.33	833.33		
2	8	R_M1 200/480 8 - GL32h	Parametric - Massive I	94484.39	184320.00	32000.00	200.0	480.0
				960.00	800.00	800.00		
3	9	SHS 100x100x5.0 9 - S355	Standardized - Cold formed Steel	440.51	271.02	271.02	100.0	100.0
				18.35	8.05	8.05		
4	8	R_M1 140/480 8 - GL32h	Parametric - Massive I	35841.51	129024.00	10976.00	140.0	480.0
				672.00	560.00	560.00		
5	8	R_M1 160/160 8 - GL32h	Parametric - Massive I	9229.65	5461.33	5461.33	160.0	160.0
				256.00	213.33	213.33		

1.2.1 SECTIONS - INFORMATION

Legend
 Thin-walled model
 Warping stiffness deactivated

Section No.	Principal Axes α [deg]	Warping I_w [cm ⁶]	Combination Type	Corrugated S. W. b [mm]	Worn out w [%]	T. Reduction [-]	Options	Comment
1	R_M1 250/400 7 - C 35/40 beton 0.00						<input checked="" type="checkbox"/>	
2	R_M1 200/480 8 - GL32h 0.00						<input checked="" type="checkbox"/>	
3	SHS 100x100x5.0 9 - S355 0.00						<input checked="" type="checkbox"/>	
4	R_M1 140/480 8 - GL32h 0.00						<input checked="" type="checkbox"/>	
5	R_M1 160/160 8 - GL32h 0.00						<input checked="" type="checkbox"/>	

2 Timber Design

2.1 ULTIMATE CONFIGURATIONS

Config. No.	Name	Members	Member Sets	Assigned to			
				Surfaces	Surface Sets	Shear Walls	Deep Beams
1	Default	All	All	3, 9, 11, 14, 16, 35, 38, 42-52, 54-57, 60-77, 81, 8	All		





Monika Spajić
Jarunska ulica 2, 10000 Zagreb



Model:
DIPLOMSKI_03_09_2024
model

Date 11.9.2024 Page 3/10
Sheet 1

TIMBER

2.1 ULTIMATE CONFIGURATIONS

Config. No.	Name	Members	Member Sets	Assigned to			
				Surfaces	Surface Sets	Shear Walls	Deep Beams
				3-87,90-136,1 38,139,141-2 38,240,241,2 43,245,247-2 58,260-270,2 72-275,278-2 84,286-306,3 12,313,315-3 98,400-402,4 04-411,413-4 15,417-427,4 32-461,464-4 99,506-513,5 15,518-524,5 26-539,543-5 63,565,567-5 87,589-610,6 13-621,624-6 41,643-653,6 55-659,661-6 63,665,669-6 89,695-726,7 30-758,761-8 13			

2.1.1 ULTIMATE CONFIGURATIONS - SETTINGS - MEMBERS

Config. No.	Description	Symbol	Value	Unit
1	Default			
	General			
	<input checked="" type="checkbox"/> Perform stability design			
	Limit Values for Special Cases			
	Tension ($\sigma_{t,0,d} / f_{t,0,d}$)	$\eta_{t,lim}$	0.001	--
	Compression ($\sigma_{c,0,d} / f_{c,0,d}$)	$\eta_{c,lim}$	0.001	--
	Shear ($\tau_{v,0,d} / f_{v,0,d}$)	$\eta_{v,lim}$	0.001	--
	Shear ($\tau_{t,0,d} / f_{t,0,d}$)	$\eta_{t,lim}$	0.001	--
	Torsion ($t_{t,0,d} / f_{t,0,d}$)	$\eta_{t,lim}$	0.010	--
	Bending ($\sigma_{m,0,d} / f_{m,0,d}$)	$\eta_{m,lim}$	0.001	--
	Bending ($\sigma_{m,0,d} / f_{m,0,d}$)	$\eta_{m,lim}$	0.001	--
	Curved and Saddle Members			
	<input checked="" type="checkbox"/> Perpendicular tension design of curved members			
	<input checked="" type="checkbox"/> Perpendicular tension design of saddle members			
	Cut-to-Grain Angle Limit			
	Allow further design if angle does not exceed limit	$ \alpha \leq$	24.00	deg
	System Strength Acc. to 6.6			
	<input type="checkbox"/> Consider system strength factor			
	Settings for Stability Design			
	Stiffness Reduction			
	<input type="checkbox"/> Reduction of stiffness with coefficient $1/(1+k_{st})$ acc. to DIN EN 1995-1-1			
	Position of Positive Transverse Load Application			
	Vertical position			
	<input checked="" type="radio"/> On section edge (destabilizing effect)			
	<input type="radio"/> At shear point			
	<input type="radio"/> At center point			
	<input type="radio"/> On section edge (stabilizing effect)			
	<input type="checkbox"/> Reduction of effective length by 0.5h acc. to Tab. 6.1 (stabilizing effect)			

2.2 SERVICEABILITY CONFIGURATIONS

Config. No.	Name	Members	Member Sets	Assigned to			
				Surfaces	Surface Sets	Shear Walls	Deep Beams
1	Default	All	All	3, 9,11,14,16-35 ,38,42-52,54- 57,60-77,81,8 3-87,90-136,1 38,139,141-2	All		



Monika Spajić
Jarunska ulica 2, 10000 Zagreb



Model:
DIPLOMSKI_03_09_2024
model

Date 11.9.2024 Page 4/10
Sheet 1

TIMBER

2.2 SERVICEABILITY CONFIGURATIONS

Config. No.	Name	Members	Member Sets	Assigned to			
				Surfaces	Surface Sets	Shear Walls	Deep Beams
				38,240,241,2 43,245,247-2 58,260-270,2 72-275,278-2 84,286-306,3 12,313,315-3 98,400-402,4 04-411,413-4 15,417-427,4 32-461,464-4 99,506-513,5 15,518-524,5 26-539,543-5 63,565,567-5 87,589-610,6 13-621,624-6 41,643-653,6 55-659,661-6 63,665,669-6 89,695-726,7 30-758,761-8 13			

2.2.1 SERVICEABILITY CONFIGURATIONS - SETTINGS - MEMBERS

Config. No.	Description	Symbol	Value	Unit
1	Default			
	Serviceability Limits to Be Checked			
	<input checked="" type="checkbox"/> Characteristic			
	<input checked="" type="checkbox"/> Quasi-permanent 1			
	<input checked="" type="checkbox"/> Quasi-permanent 2			
	Serviceability Limits (Deflections) Acc. to 7.2			
	Beam limits			
	Characteristic	L /	300	--
	Quasi-permanent 1	L /	250	--
	Quasi-permanent 2	L /	150	--
	Cantilever limits			
	Characteristic	L _c /	150	--
	Quasi-permanent 1	L _c /	125	--
	Quasi-permanent 2	L _c /	75	--
	Vibration Design			
	Vibration design	W _{inst,lim}	10.0	mm

2.3 FIRE RESISTANCE CONFIGURATIONS

Config. No.	Name	Members	Member Sets	Assigned to			
				Surfaces	Surface Sets	Shear Walls	Deep Beams
1	Default	All	All	3, 9,11,14,16-35 ,38,42-52,54- 57,60-77,81,8 3-87,90-136,1 38,139,141-2 38,240,241,2 43,245,247-2 58,260-270,2 72-275,278-2 84,286-306,3 12,313,315-3 98,400-402,4 04-411,413-4 15,417-427,4 32-461,464-4 99,506-513,5 15,518-524,5 26-539,543-5 63,565,567-5 87,589-610,6 13-621,624-6 41,643-653,6 55-659,661-6	All		



Monika Spajić
Jarunska ulica 2, 10000 Zagreb



Model:
DIPLOMSKI_03_09_2024
model

Date 11.9.2024 Page 5/10
Sheet 1

TIMBER

2.3 FIRE RESISTANCE CONFIGURATIONS

Config. No.	Name	Members	Member Sets	Assigned to			
				Surfaces	Surface Sets	Shear Walls	Deep Beams
				63,665,669-6 89,695-726,7 30-758,761-8 13			

2.3.1 FIRE RESISTANCE CONFIGURATIONS - SETTINGS - MEMBERS

Config. No.	Description	Symbol	Value	Unit
1	Default			
	Fire Design Settings			
	Required time of fire resistance	t	90	min
	Fire exposure (not for circular sections)			
	<input checked="" type="checkbox"/> Top (-z)			
	<input checked="" type="checkbox"/> Left (-y)			
	<input checked="" type="checkbox"/> Right (+y)			
	<input checked="" type="checkbox"/> Bottom (+z)			

2.4 Results

2.4.1 DESIGN RATIOS ON MEMBERS BY SECTION

Timber Design

Section No.	Member No.	Location x [m]	Stress Point No.	Design Situation	Loading No.	Design Check		Description	
						Ratio η [-]	Type		
2	R_M1 200/480 8 - GL32h								
	119	0.671		DS5	RC1	0.000	SP0100.00	Section Proof Negligible internal forces	
	121	0.818	1	DS1	CO6	0.007	SP1100.00	Section Proof Tension along grain acc. to 6.1.2	
		2.454	1	DS1	CO6	0.011	SP1200.00	Section Proof Compression along grain acc. to 6.1.4	
	312	0.044	4	DS1	CO6	0.383	SP2100.00	Section Proof Shear due to torsion acc. to 6.1.8	
	120	0.546	4	DS1	CO6	0.347	SP3100.00	Section Proof Shear in z-axis acc. to 6.1.7 Rectangular section	
	546	0.000	5	DS1	CO6	0.016	SP3200.00	Section Proof Shear in y-axis acc. to 6.1.7 Rectangular section	
	114	1.526	1	DS1	CO6	0.146	SP4100.00	Section Proof Bending about y-axis acc. to 6.1.6	
	117	3.356	1	DS5	RC4	0.002	SP4200.00	Section Proof Bending about z-axis acc. to 6.1.6	
	120	0.000	3	DS1	CO6	0.111	SP4300.00	Section Proof Biaxial bending acc. to 6.1.6	
	116	2.158	7	DS1	CO4	0.167	SP5100.00	Section Proof Bending about y-axis and tensile axial force acc. to 6.2.3	
	117	3.356	3	DS5	RC4	0.003	SP5200.00	Section Proof Bending about z-axis and tensile axial force acc. to 6.2.3	
	116	3.776	7	DS1	CO4	0.077	SP5300.00	Section Proof Biaxial bending and tensile axial force acc. to 6.2.3	
	108	1.918	1	DS1	CO6	0.117	SP6100.00	Section Proof Bending about y-axis and compressive axial force acc. to 6.2.4	
	113	0.000	3	DS1	CO6	0.004	SP6200.00	Section Proof Bending about z-axis and compressive axial force acc. to 6.2.4	
	114	0.509	3	DS1	CO6	0.080	SP6300.00	Section Proof Biaxial bending and compressive axial force acc. to 6.2.4	
	113	0.000	1	DS5	RC2	0.002	ST1300.00	Stability Axial compression with buckling about both axes acc. to 6.3.2	
	109	1.918	1	DS1	CO6	0.118	ST1600.01	Stability Bending about y-axis and compression with buckling about both axes acc. to 6.3.2	
	113	0.000	3	DS1	CO6	0.009	ST1600.02	Stability Bending about z-axis and compression with buckling about both axes acc. to 6.3.2	
	114	0.509	3	DS1	CO6	0.082	ST1600.03	Stability Biaxial bending and compression with buckling about both axes acc. to 6.3.2	
116	2.158	1	DS1	CO4	0.164	ST2100.00	Stability Flexural member without compression force Bending about y-axis acc. to 6.3.3		
111	1.918	1	DS1	CO6	0.016	ST3100.00	Stability Bending about y-axis and compression acc. to 6.3.3		
102	0.000		DS2	CO43	0.000	SE0100.01	Serviceability Negligible deflection Combination of actions 'Characteristic'		
			DS3	CO85	0.000	SE0100.02	Serviceability Negligible deflection Combination of actions 'Quasi-permanent 1'		
116	2.158	1	DS2	CO56	0.119	SE1200.01	Serviceability Combination of actions 'Characteristic' z-direction acc. to 7.2		
			DS3	CO98	0.141	SE1200.02	Serviceability Combination of actions 'Quasi-permanent 1' z-direction acc. to 7.2		
4	R_M1 140/480 8 - GL32h								
	229	3.390		DS1	CO27	0.000	SP0100.00	Section Proof Negligible internal forces	
	432	4.316	1	DS1	CO6	0.039	SP1100.00	Section Proof Tension along grain acc. to 6.1.2	
	433	0.000	1	DS1	CO6	0.043	SP1200.00	Section Proof Compression along grain acc. to 6.1.4	
	513	0.000	4	DS1	CO6	0.369	SP2100.00	Section Proof Shear due to torsion acc. to 6.1.8	
	220	0.000	4	DS1	CO6	0.963	SP3100.00	Section Proof Shear in z-axis acc. to 6.1.7 Rectangular section	
	544	0.056	2	DS1	CO6	0.458	SP3200.00	Section Proof Shear in y-axis acc. to 6.1.7 Rectangular section	
	160	0.000	1	DS1	CO3	0.232	SP4100.00	Section Proof Bending about y-axis acc. to 6.1.6	
	162	0.307	1	DS1	CO15	0.006	SP4200.00	Section Proof Bending about z-axis acc. to 6.1.6	
	161	0.070	3	DS1	CO6	0.329	SP4300.00	Section Proof Biaxial bending acc. to 6.1.6	
	432	3.836	1	DS1	CO9	0.278	SP5100.00	Section Proof Bending about y-axis and tensile axial force acc. to 6.2.3	
527	1.753	3	DS1	CO14	0.020	SP5200.00	Section Proof Bending about z-axis and tensile axial force acc. to 6.2.3		





Monika Spajić
Jarunska ulica 2, 10000 Zagreb



Model:
DIPLOMSKI_03_09_2024
model

Date 11.9.2024 Page 6/10
Sheet 1

TIMBER

2.4.1 DESIGN RATIOS ON MEMBERS BY SECTION

Timber Design

Section No.	Member No.	Location x [m]	Stress Point No.	Design Situation	Loading No.	Design Check		Description
						Ratio η [-]	Type	
4	432	4.316	1	DS1	CO6	0.403	SP5300.00	Section Proof Biaxial bending and tensile axial force acc. to 6.2.3
	201	0.226	1	DS1	CO6	0.203	SP6100.00	Section Proof Bending about y-axis and compressive axial force acc. to 6.2.4
	544	0.000	3	DS1	CO20	0.026	SP6200.00	Section Proof Bending about z-axis and compressive axial force acc. to 6.2.4
	433	0.000	9	DS1	CO18	0.484	SP6300.00	Section Proof Biaxial bending and compressive axial force acc. to 6.2.4
	242	3.328	1	DS1	CO6	0.019	ST1300.00	Stability Axial compression with buckling about both axes acc. to 6.3.2
	430	2.422	1	DS1	CO18	0.221	ST1600.01	Stability Bending about y-axis and compression with buckling about both axes acc. to 6.3.2
		4.359	3	DS1	CO9	0.123	ST1600.02	Stability Bending about z-axis and compression with buckling about both axes acc. to 6.3.2
	433	0.000	9	DS1	CO6	0.525	ST1600.03	Stability Biaxial bending and compression with buckling about both axes acc. to 6.3.2
	432	4.316	7	DS1	CO6	0.363	ST2100.00	Stability Flexural member without compression force Bending about y-axis acc. to 6.3.3
	433	0.000	7	DS1	CO6	0.360	ST3100.00	Stability Bending about y-axis and compression acc. to 6.3.3
	122	0.000		DS2	CO43	0.000	SE0100.01	Serviceability Negligible deflection Combination of actions 'Characteristic'
				DS3	CO85	0.000	SE0100.02	Serviceability Negligible deflection Combination of actions 'Quasi-permanent 1'
	429	2.606		DS2	CO51	0.004	SE1100.01	Serviceability Combination of actions 'Characteristic' y-direction acc. to 7.2
				DS3	CO93	0.005	SE1100.02	Serviceability Combination of actions 'Quasi-permanent 1' y-direction acc. to 7.2
	241	2.158		DS2	CO51	0.196	SE1200.01	Serviceability Combination of actions 'Characteristic' z-direction acc. to 7.2
			DS3	CO93	0.220	SE1200.02	Serviceability Combination of actions 'Quasi-permanent 1' z-direction acc. to 7.2	
5	96	0.000	1	DS1	CO6	0.116	SP1200.00	Section Proof Compression along grain acc. to 6.1.4
	217	1.251	4	DS1	CO6	0.032	SP3100.00	Section Proof Shear in z-axis acc. to 6.1.7 Rectangular section
	219	1.480	2	DS1	CO6	0.031	SP3200.00	Section Proof Shear in y-axis acc. to 6.1.7 Rectangular section
	96	1.251	7	DS1	CO6	0.018	SP6100.00	Section Proof Bending about y-axis and compressive axial force acc. to 6.2.4
	218	2.086	1	DS1	CO6	0.023	SP6200.00	Section Proof Bending about z-axis and compressive axial force acc. to 6.2.4
	217	2.920	7	DS1	CO6	0.161	SP6300.00	Section Proof Biaxial bending and compressive axial force acc. to 6.2.4
	97	2.336	1	DS1	CO7	0.100	ST1300.00	Stability Axial compression with buckling about both axes acc. to 6.3.2
	96	1.251	7	DS1	CO6	0.163	ST1600.01	Stability Bending about y-axis and compression with buckling about both axes acc. to 6.3.2
	97	2.336	1	DS1	CO6	0.144	ST1600.02	Stability Bending about z-axis and compression with buckling about both axes acc. to 6.3.2
		0.000	7	DS1	CO6	0.285	ST1600.03	Stability Biaxial bending and compression with buckling about both axes acc. to 6.3.2
	96	0.000		DS2	CO43	0.000	SE0100.01	Serviceability Negligible deflection Combination of actions 'Characteristic'
				DS3	CO85	0.000	SE0100.02	Serviceability Negligible deflection Combination of actions 'Quasi-permanent 1'
	97	1.168		DS2	CO52	0.040	SE1100.01	Serviceability Combination of actions 'Characteristic' y-direction acc. to 7.2
				DS3	CO94	0.044	SE1100.02	Serviceability Combination of actions 'Quasi-permanent 1' y-direction acc. to 7.2
				DS2	CO52	0.057	SE1200.01	Serviceability Combination of actions 'Characteristic' z-direction acc. to 7.2
			DS3	CO94	0.063	SE1200.02	Serviceability Combination of actions 'Quasi-permanent 1' z-direction acc. to 7.2	





Monika Spajić
Jarunska ulica 2, 10000 Zagreb



Model:
DIPLOMSKI_03_09_2024
model

Date 11.9.2024 Page 7/10
Sheet 1

MODEL

2.5 MEMBER NO. 96 | DS1 | CO6 | 1.251 M | LEFT SIDE | STRESS POINT NO. 7 | ST1600.01

Timber Design

Design Check ST1600.01 | EN 1995 | CEN | 2014-05

Stability

Bending about y-axis and compression with buckling about both axes acc. to 6.3.2

$$f_{c,0,d} = k_{mod} \cdot \frac{f_{c,0,k}}{\gamma_M}$$

$$= 0,80 \cdot \frac{32.000 \text{ N/mm}^2}{1,25}$$

$$= 20.480 \text{ N/mm}^2$$

2.4.1, Eq. 2.14

$$f_{m,y,d} = k_{mod} \cdot \frac{f_{m,y,k}}{\gamma_M}$$

$$= 0,80 \cdot \frac{32.000 \text{ N/mm}^2}{1,25}$$

$$= 20.480 \text{ N/mm}^2$$

2.4.1, Eq. 2.14

$$\lambda_y = \frac{L_{cr,y}}{i_y}$$

$$= \frac{2.920 \text{ m}}{46,2 \text{ mm}}$$

$$= 63,22$$

$$\lambda_z = \frac{L_{cr,z}}{i_z}$$

$$= \frac{2.920 \text{ m}}{46,2 \text{ mm}}$$

$$= 63,22$$

$$\lambda_{rel,y} = \frac{\lambda_y}{\pi} \cdot \sqrt{\frac{f_{c,0,k}}{E_{0,05,y}}}$$

$$= \frac{63,22}{\pi} \cdot \sqrt{\frac{32.000 \text{ N/mm}^2}{11800,0 \text{ N/mm}^2}}$$

$$= 1,05$$

6.3.2, Eq. 6.21

$$\lambda_{rel,z} = \frac{\lambda_z}{\pi} \cdot \sqrt{\frac{f_{c,0,k}}{E_{0,05,z}}}$$

$$= \frac{63,22}{\pi} \cdot \sqrt{\frac{32.000 \text{ N/mm}^2}{11800,0 \text{ N/mm}^2}}$$

$$= 1,05$$

6.3.2, Eq. 6.22

$$\lambda_{rel,y} > 0,3 \text{ or } \lambda_{rel,z} > 0,3$$

$$k_y = 0,5 \cdot \left(1 + \beta_c \cdot (\lambda_{rel,y} - 0,3) + (\lambda_{rel,y})^2 \right)$$

$$= 0,5 \cdot \left(1 + 0,10 \cdot (1,05 - 0,3) + (1,05)^2 \right)$$

$$= 1,09$$

6.3.2, Eq. 6.27

$$k_z = 0,5 \cdot \left(1 + \beta_c \cdot (\lambda_{rel,z} - 0,3) + (\lambda_{rel,z})^2 \right)$$

$$= 0,5 \cdot \left(1 + 0,10 \cdot (1,05 - 0,3) + (1,05)^2 \right)$$

$$= 1,09$$

6.3.2, Eq. 6.28

$$k_{c,y} = \frac{1}{k_y + \sqrt{(k_y)^2 - (\lambda_{rel,y})^2}}$$

$$= \frac{1}{1,09 + \sqrt{(1,09)^2 - (1,05)^2}}$$

$$= 0,73$$

6.3.2, Eq. 6.25

$$k_{c,z} = \frac{1}{k_z + \sqrt{(k_z)^2 - (\lambda_{rel,z})^2}}$$

$$= \frac{1}{1,09 + \sqrt{(1,09)^2 - (1,05)^2}}$$

$$= 0,73$$

6.3.2, Eq. 6.26



Monika Spajić
Jarunska ulica 2, 10000 Zagreb



Model:
DIPLOMSKI_03_09_2024
model

Date 11.9.2024 Page 8/10
Sheet 1

MODEL

2.5 MEMBER NO. 96 | DS1 | CO6 | 1.251 M | LEFT SIDE | STRESS POINT NO. 7 | ST1600.01

Timber Design

$$\eta_1 = \frac{\frac{\sigma_{c,0,d}}{k_{c,y} \cdot f_{c,0,d}} + \frac{\sigma_{m,y,d}}{f_{m,y,d}}}{\frac{-2.367 \text{ N/mm}^2}{0.73 \cdot 20.480 \text{ N/mm}^2} + \frac{-0.098 \text{ N/mm}^2}{20.480 \text{ N/mm}^2}}$$

$$= 0.163$$

Eq. 6.23

$$\eta_2 = \frac{\frac{\sigma_{c,0,d}}{k_{c,z} \cdot f_{c,0,d}} + k_m \cdot \frac{\sigma_{m,y,d}}{f_{m,y,d}}}{\frac{-2.367 \text{ N/mm}^2}{0.73 \cdot 20.480 \text{ N/mm}^2} + 0.70 \cdot \frac{-0.098 \text{ N/mm}^2}{20.480 \text{ N/mm}^2}}$$

$$= 0.162$$

Eq. 6.24

$$\eta = \max(\eta_1, \eta_2)$$

$$= \max(0.163, 0.162)$$

$$= 0.163$$

6.3.2

$$\eta = 0.163 \leq 1 \quad \checkmark$$

- $f_{c,0,d}$ Design compressive strength
- k_{mod} Modification factor
- $f_{c,0,k}$ Characteristic compressive strength
- γ_M Partial factor
- $f_{m,y,d}$ Design bending strength
- $f_{m,y,k}$ Characteristic bending strength
- λ_y Slenderness ratio
- $L_{cr,y}$ Equivalent member length
- i_y Radius of gyration
- λ_z Slenderness ratio
- $L_{cr,z}$ Equivalent member length
- i_z Radius of gyration
- $\lambda_{rel,y}$ Relative slenderness ratio
- $E_{0,05,y}$ Modulus of elasticity
- $\lambda_{rel,z}$ Relative slenderness ratio
- $E_{0,05,z}$ Modulus of elasticity
- k_y Instability factor
- β_c Straightness factor
- k_z Instability factor
- $k_{c,y}$ Instability factor
- $k_{c,z}$ Instability factor
- η_1 Design ratio 1
- $\sigma_{c,0,d}$ Design compressive stress
- $\sigma_{m,y,d}$ Design bending stress
- η_2 Design ratio 2
- k_m Redistribution factor





Monika Spajić
Jarunska ulica 2, 10000 Zagreb



Model:
DIPLOMSKI_03_09_2024
model

Date 11.9.2024 Page 9/10
Sheet 1

MODEL

2.6 MEMBER NO. 220 | DS1 | CO6 | 0.000 M | STRESS POINT NO. 4 | SP3100

Timber Design

Design Check SP3100 | EN 1995 | CEN | 2014-05

Section Proof
Shear in z-axis acc. to 6.1.7 | Rectangular section

$$f_{v,z,d} = k_{mod} \cdot \frac{f_{v,z,k}}{\gamma_M}$$

$$= 0,80 \cdot \frac{3.500 \text{ N/mm}^2}{1,25}$$

$$= 2.240 \text{ N/mm}^2$$

$$\tau_{xz,d} = \frac{\tau_{xz}}{k_{Cr}}$$

$$= \frac{1.446 \text{ N/mm}^2}{0,67}$$

$$= 2.158 \text{ N/mm}^2$$

$$\eta = \frac{|\tau_{xz,d}|}{f_{v,z,d}}$$

$$= \frac{2.158 \text{ N/mm}^2}{2.240 \text{ N/mm}^2}$$

$$= 0.963$$

$\eta = 0.963 \leq 1$ ✓

2.4.1, Eq. 2.14

6.1.7, Eq. 6.13

- $f_{v,z,d}$ Design shear strength
- k_{mod} Modification factor
- $f_{v,z,k}$ Characteristic shear strength
- γ_M Partial factor
- $\tau_{xz,d}$ Design shear stress
- τ_{xz} Shear stress
- k_{Cr} Crack influence factor





Monika Spajić
Jarunska ulica 2, 10000 Zagreb



Model:
DIPLOMSKI_03_09_2024
model

Date 11.9.2024 Page 10/10
Sheet 1

MODEL

2.7 MEMBER NO. 312 | DS1 | CO6 | 0.044 M | STRESS POINT NO. 4 | SP2100

Timber Design

Design Check SP2100 | EN 1995 | CEN | 2014-05

Section Proof
Shear due to torsion acc. to 6.1.8

$$f_{v,z,d} = k_{mod} \cdot \frac{f_{v,z,k}}{\gamma_M}$$

$$= 0,80 \cdot \frac{3.500 \text{ N/mm}^2}{1,25}$$

$$= 2.240 \text{ N/mm}^2$$

2.4.1, Eq. 2.14

$$f_{v,y,d} = k_{mod} \cdot \frac{f_{v,y,k}}{\gamma_M}$$

$$= 0,80 \cdot \frac{3.500 \text{ N/mm}^2}{1,25}$$

$$= 2.240 \text{ N/mm}^2$$

2.4.1, Eq. 2.14

$$\eta = \frac{\tau_{tor,d}}{k_{shape} \cdot f_{v,d}}$$

$$= \frac{0.960 \text{ N/mm}^2}{1,12 \cdot 2.240 \text{ N/mm}^2}$$

$$= 0.383$$

6.1.8, Eq. 6.14

$\eta = 0.383 \leq 1$ ✓

- $f_{v,z,d}$ Design shear strength
- k_{mod} Modification factor
- $f_{v,z,k}$ Characteristic shear strength
- γ_M Partial factor
- $f_{v,y,d}$ Design shear strength
- $f_{v,y,k}$ Characteristic shear strength
- $\tau_{tor,d}$ Design torsional stress
- k_{shape} Torsion factor
- $f_{v,d}$ Design shear strength





3.5.1.2. Dimenzioniranje CLT zidnih panela (d=20 cm i d=14 cm)

Monika Spajić
Jarunska ulica 2, 10000 Zagreb



Model:
DIPLOMSKI_03_09_2024
model

Date 11.9.2024 Page 1/8
Sheet 1

MODEL

CONTENTS

1	Basic Objects	2	2.3	Fire Resistance Configurations	4
1.1	Materials	2	2.3.1	Fire Resistance Configurations - Settings - Surfaces	4
1.2	Sections	2	2.4	Results	5
1.2.1	Sections - Information	2	2.4.1	Design Ratios on Surfaces by Thickness	5
2	Timber Design	2	2.5	Surface No. 572 DS3 CO90 Mesh Node No. 50007 Element No. 50988 SE5000.02	6
2.1	Ultimate Configurations	2	2.6	Surface No. 572 DS1 CO6 Mesh Node No. 50005 Element No. 50985 UL6100	7
2.1.1	Ultimate Configurations - Settings - Surfaces	3	2.7	Surface No. 676 DS1 CO6 Mesh Node No. 56094 Element No. 58579 UL1300	8
2.2	Serviceability Configurations	3			
2.2.1	Serviceability Configurations - Settings - Surfaces	4			



Monika Spajić
Jarunska ulica 2, 10000 Zagreb



Model:
DIPLOMSKI_03_09_2024
model

Date 11.9.2024 Page 2/8
Sheet 1

MODEL

1 Basic Objects

1.1 MATERIALS

Legend
 Stiffness modification

Material No.	Material Name	Material Type	Analysis Model	Options
6	Stora Enso (40 mm) Orthotropic Linear Elastic (Surfaces)	Timber	Orthotropic Linear Elastic (Surfaces)	<input checked="" type="checkbox"/>
7	C 35/40 beton	Concrete	Isotropic Linear Elastic	
8	GL32h Isotropic Linear Elastic	Timber	Isotropic Linear Elastic	<input checked="" type="checkbox"/>
9	S355 Isotropic Linear Elastic	Steel	Isotropic Linear Elastic	
10	Stora Enso (30 mm) Orthotropic Linear Elastic (Surfaces)	Timber	Orthotropic Linear Elastic (Surfaces)	<input checked="" type="checkbox"/>
11	Stora Enso (20 mm) Orthotropic Linear Elastic (Surfaces)	Timber	Orthotropic Linear Elastic (Surfaces)	<input checked="" type="checkbox"/>

1.2 SECTIONS

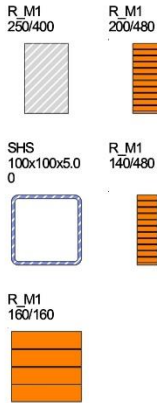

Section No.	Material No.	Section Type	Manufacturing Type	I_x [cm ⁴]	I_y [cm ⁴]	I_z [cm ⁴]	Overall Dimensions b [mm]	h [mm]
1	7	R_M1 250/400 7 - C 35/40 beton	Parametric - Massive I	127345.16	133333.33	52063.33	250.0	400.0
				1000.00	833.33	833.33		
2	8	R_M1 200/480 8 - GL32h	Parametric - Massive I	94484.39	184320.00	32000.00	200.0	480.0
				960.00	800.00	800.00		
3	9	SHS 100x100x5.0 9 - S355	Standardized - Cold formed Steel	440.51	271.02	271.02	100.0	100.0
				18.35	8.05	8.05		
4	8	R_M1 140/480 8 - GL32h	Parametric - Massive I	35841.51	129024.00	10976.00	140.0	480.0
				672.00	560.00	560.00		
5	8	R_M1 160/160 8 - GL32h	Parametric - Massive I	9229.65	5461.33	5461.33	160.0	160.0
				256.00	213.33	213.33		

1.2.1 SECTIONS - INFORMATION

Legend
 Thin-walled model
 Warping stiffness deactivated

Section No.	Principal Axes α [deg]	Warping I_w [cm ⁶]	Combination Type	Corrugated S. W. b [mm]	Worn out w [%]	T. Reduction [-]	Options	Comment
1	R_M1 250/400 7 - C 35/40 beton 0.00						<input checked="" type="checkbox"/>	
2	R_M1 200/480 8 - GL32h 0.00						<input checked="" type="checkbox"/>	
3	SHS 100x100x5.0 9 - S355 0.00						<input checked="" type="checkbox"/>	
4	R_M1 140/480 8 - GL32h 0.00						<input checked="" type="checkbox"/>	
5	R_M1 160/160 8 - GL32h 0.00						<input checked="" type="checkbox"/>	

2 Timber Design

2.1 ULTIMATE CONFIGURATIONS

Config. No.	Name	Members	Member Sets	Assigned to			
				Surfaces	Surface Sets	Shear Walls	Deep Beams
1	Default	All	All	3, 9,11,14,16,35,38,42-52,54-57,60-77,81,8	All		





Monika Spajić
Jarunska ulica 2, 10000 Zagreb



Model:
DIPLOMSKI_03_09_2024
model

Date 11.9.2024 Page 3/8
Sheet 1

TIMBER

2.1 ULTIMATE CONFIGURATIONS

Config. No.	Name	Members	Member Sets	Assigned to			
				Surfaces	Surface Sets	Shear Walls	Deep Beams
				3-87,90-136,1 38,139,141-2 38,240,241,2 43,245,247-2 58,260-270,2 72-275,278-2 84,286-306,3 12,313,315-3 98,400-402,4 04-411,413-4 15,417-427,4 32-461,464-4 99,506-513,5 15,518-524,5 26-539,543-5 63,565,567-5 87,589-610,6 13-621,624-6 41,643-653,6 55-659,661-6 63,665,669-6 89,695-726,7 30-758,761-8 13			

2.1.1 ULTIMATE CONFIGURATIONS - SETTINGS - SURFACES

Config. No.	Description	Symbol	Value	Unit
1	Default			
	Limit Values for Special Cases			
	Tension ($\sigma_{t,0,d} / f_{t,0,d}$)	$\eta_{t,0,lim}$	0.001	--
	Tension perpendicular ($\sigma_{t,90,d} / f_{t,90,d}$)	$\eta_{t,90,lim}$	0.001	--
	Compression ($\sigma_{c,0,d} / f_{c,0,d}$)	$\eta_{c,0,lim}$	0.001	--
	Compression perpendicular ($\sigma_{c,90,d} / f_{c,90,d}$)	$\eta_{c,90,lim}$	0.001	--
	Shear in yz-plane ($\tau_{yz} / f_{v,yz,d}$)	$\eta_{yz,lim}$	0.001	--
	Shear in xz-plane ($\tau_{xz} / f_{v,xz,d}$)	$\eta_{xz,lim}$	0.001	--
	Shear in xy-plane ($\tau_{xy} / f_{v,xy,d}$)	$\eta_{xy,lim}$	0.001	--
	Shear on net section ($T_{net} / f_{v,net,d}$)	$\eta_{net,lim}$	0.001	--
	Equivalent torsion ($T_{tor} / f_{v,tor,d}$)	$\eta_{tor,lim}$	0.001	--
	Bending ($\sigma_{b,0,d} / f_{m,0,d}$)	$\eta_{b,0,lim}$	0.001	--
	Bending perpendicular ($\sigma_{b,90,d} / f_{m,90,d}$)	$\eta_{b,90,lim}$	0.001	--
	System Strength			
	<input type="checkbox"/> Consider system strength factor			

2.2 SERVICEABILITY CONFIGURATIONS

Config. No.	Name	Members	Member Sets	Assigned to			
				Surfaces	Surface Sets	Shear Walls	Deep Beams
1	Default	All	All	3, 9,11,14,16-35 ,38,42-52,54- 57,60-77,81,8 3-87,90-136,1 38,139,141-2 38,240,241,2 43,245,247-2 58,260-270,2 72-275,278-2 84,286-306,3 12,313,315-3 98,400-402,4 04-411,413-4 15,417-427,4 32-461,464-4 99,506-513,5 15,518-524,5 26-539,543-5 63,565,567-5 87,589-610,6 13-621,624-6 41,643-653,6 55-659,661-6 63,665,669-6	All		





Monika Spajić
Jarunska ulica 2, 10000 Zagreb



Model:
DIPLOMSKI_03_09_2024
model

Date 11.9.2024 Page 4/8
Sheet 1

TIMBER

2.2 SERVICEABILITY CONFIGURATIONS

Config. No.	Name	Members	Member Sets	Assigned to			
				Surfaces	Surface Sets	Shear Walls	Deep Beams
				89,695-726,7 30-758,761-8 13			

2.2.1 SERVICEABILITY CONFIGURATIONS - SETTINGS - SURFACES

Config. No.	Description	Symbol	Value	Unit
1	Default			
	Serviceability Limits to Be Checked			
	<input checked="" type="checkbox"/> Characteristic			
	<input checked="" type="checkbox"/> Quasi-permanent 1			
	<input checked="" type="checkbox"/> Quasi-permanent 2			
	Serviceability Limits (Deflections) Acc. to 7.2			
	Limit for double-supported surface			
	Characteristic	L/	300	--
	Quasi-permanent 1	L/	250	--
	Quasi-permanent 2	L/	150	--
	Limit for cantilever surface			
	Characteristic	L _c /	150	--
	Quasi-permanent 1	L _c /	125	--
	Quasi-permanent 2	L _c /	75	--
	Vibration Design			
	Vibration design	W _{lim}	5.0	mm

2.3 FIRE RESISTANCE CONFIGURATIONS

Config. No.	Name	Members	Member Sets	Assigned to			
				Surfaces	Surface Sets	Shear Walls	Deep Beams
1	Default	All	All	3, 9,11,14,16-35 ,38,42-52,54- 57,60-77,81,8 3-87,90-136,1 38,139,141-2 38,240,241,2 43,245,247-2 58,260-270,2 72-275,278-2 84,286-306,3 12,313,315-3 98,400-402,4 04-411,413-4 15,417-427,4 32-461,464-4 99,506-513,5 15,518-524,5 26-539,543-5 63,565,567-5 87,589-610,6 13-621,624-6 41,643-653,6 55-659,661-6 63,665,669-6 89,695-726,7 30-758,761-8 13	All		

2.3.1 FIRE RESISTANCE CONFIGURATIONS - SETTINGS - SURFACES

Config. No.	Description	Symbol	Value	Unit
1	Default			
	Fire Design Settings			
	Required time of fire resistance	t	90	min
	<input type="radio"/> Wall			
	<input checked="" type="radio"/> Ceiling			
	<input type="radio"/> Heat-proof adhesive of cross-laminated timber layers			
	<input checked="" type="radio"/> Non-heat-proof adhesive of cross-laminated timber layers			
	Coefficient increasing charring rate of inner layers	k _φ	2.00	--





Monika Spajić
Jarunska ulica 2, 10000 Zagreb



Model:
DIPLOMSKI_03_09_2024
model

Date 11.9.2024 Page 5/8
Sheet 1

TIMBER

2.3.1 FIRE RESISTANCE CONFIGURATIONS - SETTINGS - SURFACES

Config. No.	Description	Symbol	Value	Unit
	<input type="checkbox"/> User-defined coefficient of layer thickness with zero strength			
	Thickness to omit fire reduced layer		3.0	mm
Fire exposure				
	<input type="checkbox"/> Top (-z)			
	<input checked="" type="checkbox"/> Bottom (+z)			
	<input checked="" type="checkbox"/> Consider non-heat-proof adhesive from bottom			
	<input type="checkbox"/> Initial fire protection from bottom (+z)			

2.4 Results

2.4.1 DESIGN RATIOS ON SURFACES BY THICKNESS

Timber Design

Thick. No.	Surface No.	Point No.	Point Coordinates [m]			Design Situation	Loading No.	Layer No.	Side	Design Check		Description
			X	Y	Z				Ratio η [-]	Type		
2	CLT-200 676	56103	46.906	22.955	-3.651	DS1	CO1	1	Top	0.000	✓	UL0100.00 Ultimate Limit State Negligible stresses
		56074	45.536	22.955	-2.400	DS1	CO6	1	Top	0.071	✓	UL1100.00 Ultimate Limit State Tension along grain
		56094	47.696	22.955	-1.700	DS1	CO6	2	Top	0.246	✓	UL1300.00 Ultimate Limit State Compression along grain
		91	42.836	22.955	0.000	DS1	CO6	3	Top	0.164	✓	UL3010.00 Ultimate Limit State Shear in yz-plane
			42.836	22.955	0.000	DS1	CO6	2	Bottom	0.043	✓	UL3020.00 Ultimate Limit State Shear in xz-plane
			42.836	22.955	0.000	DS1	CO6	1	Top	0.166	✓	UL3110.00 Ultimate Limit State Shear in xy-plane Failure mechanism 1
		56065	43.676	22.955	0.000	DS1	CO6	4	Top	0.009	✓	UL3400.00 Ultimate Limit State Shear in xz-plane and xy-plane
		95	50.036	22.955	0.000	DS1	CO6	2	Top	0.059	✓	UL4100.00 Ultimate Limit State Bending along grain
		56074	45.536	22.955	-2.400	DS1	CO10	1	Top	0.069	✓	UL5100.00 Ultimate Limit State Bending and tension along grain
		56094	47.696	22.955	-1.700	DS1	CO10	2	Top	0.234	✓	UL6100.00 Ultimate Limit State Bending and compression along grain
		91	42.836	22.955	0.000	DS2	CO43			0.000	✓	SE0500.00 Serviceability Negligible deflections
		56077	46.496	22.955	-1.920	DS2	CO80			0.049	✓	SE5000.01 Serviceability Combination of actions 'Characteristic' Deflection in z-direction
			46.496	22.955	-1.920	DS3	CO122			0.042	✓	SE5000.02 Serviceability Combination of actions 'Quasi-permanent 1' Deflection in z-direction
3	CLT-140 572	50014	48.412	22.955	-6.480	DS1	CO23	2	Middle	0.000	✓	UL0100.00 Ultimate Limit State Negligible stresses
		5759	42.836	22.955	-7.000	DS1	CO6	2	Top	0.101	✓	UL1100.00 Ultimate Limit State Tension along grain
		50016	43.197	22.955	-6.013	DS1	CO6	1	Top	0.204	✓	UL1300.00 Ultimate Limit State Compression along grain
		92	42.836	22.955	-4.080	DS1	CO6	2	Top	0.050	✓	UL3010.00 Ultimate Limit State Shear in yz-plane
			42.836	22.955	-4.080	DS1	CO6	3	Middle	0.015	✓	UL3020.00 Ultimate Limit State Shear in xz-plane
		1073	45.936	22.955	-4.080	DS1	CO6	5	Bottom	0.141	✓	UL3110.00 Ultimate Limit State Shear in xy-plane Failure mechanism 1
			45.936	22.955	-4.080	DS1	CO6	5	Middle	0.016	✓	UL3400.00 Ultimate Limit State Shear in xz-plane and xy-plane
		15818	44.903	22.955	-4.080	DS1	CO4	1	Top	0.059	✓	UL4100.00 Ultimate Limit State Bending along grain
		5759	42.836	22.955	-7.000	DS1	CO6	2	Top	0.107	✓	UL5100.00 Ultimate Limit State Bending and tension along grain
		50005	47.945	22.955	-5.547	DS1	CO6	1	Top	0.231	✓	UL6100.00 Ultimate Limit State Bending and compression along grain
		92	42.836	22.955	-4.080	DS2	CO43			0.000	✓	SE0500.00 Serviceability Negligible deflections
		50007	48.412	22.955	-5.080	DS2	CO48			0.065	✓	SE5000.01 Serviceability Combination of actions 'Characteristic' Deflection in z-direction
			48.412	22.955	-5.080	DS3	CO90			0.078	✓	SE5000.02 Serviceability Combination of actions 'Quasi-permanent 1' Deflection in z-direction





Monika Spajić
Jarunska ulica 2, 10000 Zagreb



Model:
DIPLOMSKI_03_09_2024
model

Date: 11.9.2024 Page: 6/8
Sheet: 1

MODEL

2.5 **SURFACE NO. 572 | D53 | CO90 | MESH NODE NO. 50007 | ELEMENT NO. 50988 | SE5000.02** Timber Design

Design Check SE5000.02 | EN 1995 | CEN | 2014-05

Serviceability
Combination of actions 'Quasi-permanent 1' | Deflection in z-direction

Design situation: Quasi-permanent 1
Surface type: Double-supported

$$w_{fin,limit,z} = \frac{l}{l/w_{fin,limit,z}}$$

$$= \frac{3.101 \text{ m}}{250}$$

$$= 12.4 \text{ mm}$$

$$\eta = \frac{|w_{fin,z}|}{w_{fin,limit,z}}$$

$$= \frac{|1.0 \text{ mm}|}{12.4 \text{ mm}}$$

$$= 0.078$$

$\eta = 0.078 \leq 1$ ✓

- $w_{fin,limit,z}$ Limit value of deflection
- l Reference length
- $l / w_{fin,limit,z}$ Limit value criterion
- $w_{fin,z}$ Deflection

Monika Spajić
Jarunska ulica 2, 10000 Zagreb



Model:
DIPLOMSKI_03_09_2024
model

Date 11.9.2024 Page 7/8
Sheet 1

MODEL

2.6 SURFACE NO. 572 | DS1 | CO6 | MESH NODE NO. 50005 | ELEMENT NO. 50985 | UL6100

Timber Design

Design Check UL6100 | EN 1995 | CEN | 2014-05

Ultimate Limit State
Bending and compression along grain

$$f_{c,0,d} = k_{mod} \cdot \frac{f_{c,0,k}}{\gamma_M}$$

$$= 0,80 \cdot \frac{21.000 \text{ N/mm}^2}{1,20}$$

$$= 14.000 \text{ N/mm}^2$$

$$f_{m,0,d} = k_{mod} \cdot \frac{f_{m,0,k}}{\gamma_M}$$

$$= 0,80 \cdot \frac{24.000 \text{ N/mm}^2}{1,20}$$

$$= 16.000 \text{ N/mm}^2$$

$$\eta = \frac{|\sigma_{c,0,d}|}{f_{c,0,d}} + \frac{|\sigma_{b,0,d}|}{f_{m,0,d}}$$

$$= \frac{|-2.680 \text{ N/mm}^2|}{14.000 \text{ N/mm}^2} + \frac{|-0.632 \text{ N/mm}^2|}{16.000 \text{ N/mm}^2}$$

$$= 0.231$$

$\eta = 0.231 \leq 1$ ✓

- $f_{c,0,d}$ Design compressive strength along grain
- k_{mod} Modification factor
- $f_{c,0,k}$ Characteristic compressive strength along grain
- γ_M Partial factor
- $f_{m,0,d}$ Design bending strength along grain
- $f_{m,0,k}$ Characteristic bending strength along grain
- $\sigma_{c,0,d}$ Design compressive stress along grain
- $\sigma_{b,0,d}$ Design bending stress along grain



Monika Spajić
Jarunska ulica 2, 10000 Zagreb



Model:
DIPLOMSKI_03_09_2024
model

Date 11.9.2024 Page 8/8
Sheet 1

MODEL

2.7 SURFACE NO. 676 | DS1 | CO6 | MESH NODE NO. 56094 | ELEMENT NO. 58579 | UL1300

Timber Design

Design Check UL1300 | EN 1995 | CEN | 2014-05

Ultimate Limit State
Compression along grain

$$f_{c,0,d} = k_{mod} \cdot \frac{f_{c,0,k}}{\gamma_M}$$

$$= 0,80 \cdot \frac{21.000 \text{ N/mm}^2}{1,20}$$

$$= 14.000 \text{ N/mm}^2$$

$$\eta = \frac{|\sigma_{c,0,d}|}{f_{c,0,d}}$$

$$= \frac{|-3.448 \text{ N/mm}^2|}{14.000 \text{ N/mm}^2}$$

$$= 0,246$$

$$\eta = 0,246 \leq 1 \quad \checkmark$$

- $f_{c,0,d}$ Design compressive strength along grain
- k_{mod} Modification factor
- $f_{c,0,k}$ Characteristic compressive strength along grain
- γ_M Partial factor
- $\sigma_{c,0,d}$ Design compressive stress along grain



3.5.1.3. Dimenzioniranje elemenata (S355) – čelični stupovi

Monika Spajić
Jarunska ulica 2, 10000 Zagreb



Model:
DIPLOMSKI_03_09_2024
model

Date 11.9.2024 Page 1/9
Sheet 1

MODEL

CONTENTS

1	Steel Design	2	1.4	Fire Resistance Configurations	3
1.1	Sections	2	1.4.1	Fire Resistance Configurations - Settings	3
1.2	Ultimate Configurations	2	1.5	Results	4
1.2.1	Ultimate Configurations - Settings	2	1.5.1	Design Ratios on Members by Section	4
1.3	Serviceability Configurations	3	1.6	Member No. 33 DS1 CO9 0.000 m SP1200	5
1.3.1	Serviceability Configurations - Settings	3	1.7	Member No. 33 DS1 CO9 0.000 m ST1300	6
			1.8	Member No. 33 DS1 CO9 0.000 m ST1100	8



Monika Spajić
Jarunska ulica 2, 10000 Zagreb



Model:
DIPLOMSKI_03_09_2024
model

Date 11.9.2024 Page 2/9
Sheet 1

STEEL

1 Steel Design

1.1 SECTIONS

Legend
 Thin-walled model
 Warping stiffness deactivated

Section No.	Name	Material	To Design	Section Type	Use Other Section for Design	Section Classification	Options
1	R_M1 250/400	7	<input checked="" type="checkbox"/>	Parametric - Massive I	<input type="checkbox"/>	Class 3	<input type="checkbox"/>
2	R_M1 200/480	8	<input checked="" type="checkbox"/>	Parametric - Massive I	<input type="checkbox"/>	Class 3	<input type="checkbox"/>
3	SHS 100x100x5.00	9	<input checked="" type="checkbox"/>	Standardized - Steel	<input type="checkbox"/>	Automatically	<input checked="" type="checkbox"/>
4	R_M1 140/480	8	<input checked="" type="checkbox"/>	Parametric - Massive I	<input type="checkbox"/>	Class 3	<input type="checkbox"/>
5	R_M1 160/160	8	<input checked="" type="checkbox"/>	Parametric - Massive I	<input type="checkbox"/>	Class 3	<input type="checkbox"/>

1.2 ULTIMATE CONFIGURATIONS

Config. No.	Name	Members	Member Sets	Shear Walls	Deep beams
1	Default	All	All	All	All

1.2.1 ULTIMATE CONFIGURATIONS - SETTINGS

Config. No.	Description	Symbol	Value	Unit
1	Default			
	General			
	<input checked="" type="checkbox"/> Perform stability design			
	Limit Values for Special Cases			
	Tension ($N_{t,Ed} / N_{t,Rd}$)	η_t	0.001	-
	Compression ($N_{c,Ed} / N_{c,Rd}$)	η_c	0.001	-
	Shear ($V_{d,Ed} / V_{d,Rd}$)	η_v	0.001	-
	Shear ($V_{t,Ed} / V_{t,Rd}$)	η_s	0.001	-
	Shear stress due to torsion ($\tau_{t,Ed} / \tau_{t,Rd}$)	η_{τ}	0.010	-
	Bending about major axis ($M_{y,Ed} / M_{y,Rd}$)	η_{ly}	0.001	-
	Bending about minor axis ($M_{z,Ed} / M_{z,Rd}$)	η_{lz}	0.001	-
	Thin-Walled Analysis			
	Maximum number of iterations	η_{max}	3	
	Maximum difference between iterations	δ_{max}	1.00	%
	<input type="checkbox"/> Neglect bending moments due to the shift of the centroid			
	<input type="checkbox"/> Consider effective widths according to EN 1993-1-5, Annex E			
	Options			
	Elastic design			
	<input type="checkbox"/> Elastic design (also for class 1 and class 2 sections)			
	<input type="checkbox"/> Use verification acc. to equation 6.1 for elastic design			
	Plastic design			
	<input type="checkbox"/> Use linear interaction acc. to 6.2.1(7) for section check for M+N			
	Design of Cold-Formed Sections Acc. to EN 1993-1-3			
	<input checked="" type="checkbox"/> Perform design of cold-formed sections			
	Forming factor k acc. to 3.2.2(3)			
	<input type="checkbox"/> Use elastic design acc. to 6.1.6			
	<input type="checkbox"/> Consider web as stiffened acc. to Tab. 6.1			
	<input checked="" type="checkbox"/> Determine local transverse resistance of web acc. to 6.1.7			
	Limiting inclination of principal axes acc. to 6.2.4(2)	α_{lim}	0.00	deg
	Design of Shear Buckling Acc. to EN 1993-1-5			
	<input checked="" type="checkbox"/> Perform design of shear buckling			
	Stability Analyses with Second-Order Internal Forces			
	<input type="checkbox"/> Use γ_{M1} for determination of the section resistance			
	Settings for Stability Design			
	Calculation Method			
	Equivalent member method (effective lengths)			
	Structure Type acc. to Table B.3			
	<input type="checkbox"/> Sway y-y ($C_{my} = 0.9$)			
	<input type="checkbox"/> Sway z-z ($C_{mz} = 0.9$)			
	2D - General method (4 degrees of freedom)			
	<input checked="" type="checkbox"/> Enable also for non-I-sections			
	<input type="checkbox"/> Extension methods			
	Include Second-Order Effects Acc. to 5.2.2(4) by Increasing Bending Moment About			
	<input type="checkbox"/> Major y-axis			
	<input type="checkbox"/> Minor z-axis			





Monika Spajić
Jarunska ulica 2, 10000 Zagreb



Model:
DIPLOMSKI_03_09_2024
model

Date 11.9.2024 Page 3/9
Sheet 1

STEEL

1.2.1 **ULTIMATE CONFIGURATIONS - SETTINGS**

Config. No.	Description	Symbol	Value	Unit
	Position of Positive Transverse Load Application			
	Vertical position			
	<input checked="" type="radio"/> On profile edge (destabilizing effect)			
	<input type="radio"/> At shear point			
	<input type="radio"/> At center point			
	<input type="radio"/> On profile edge (stabilizing effect)			
	Parameters for Lateral-Torsional Buckling			
	6.3.2.3 Determine lateral-torsional buckling curves for 6.3.2 and 6.3.3			
	<input type="radio"/> Always according to Eq. 6.56 General case (conservative)			
	<input checked="" type="radio"/> If possible, according to Eq. 6.57, otherwise according to Eq. 6.56			
	<input checked="" type="checkbox"/> Use factor f for modification of χ_{LT} acc. to 6.3.2.3(2)			
	6.3.3(4) Parameters k_{yy} , k_{zz} , k_{y1} , k_{z1}			
	Determine interaction factors for 6.3.3(4) according to			
	<input type="radio"/> Method 1 acc. to Annex A			
	<input checked="" type="radio"/> Method 2 acc. to Annex B			
	Lateral-Torsional Buckling of Hollow Sections			
	<input checked="" type="checkbox"/> Perform design for non-circular doubly symmetric hollow sections			
	Stability Design of Cold-Formed Sections Acc. to EN 1993-1-3			
	<input checked="" type="checkbox"/> Design of bending with axial force acc. to 6.2.5(2) or 6.3			

1.3 **SERVICEABILITY CONFIGURATIONS**

Config. No.	Name	Members	Assigned to		
			Member Sets	Shear Walls	Deep beams
1	Default	All	All	All	All

1.3.1 **SERVICEABILITY CONFIGURATIONS - SETTINGS**

Config. No.	Description	Symbol	Value	Unit
1	Default			
	Serviceability Limits (Deflections) Acc. to 7.2			
	Beam limits - action combination (Table A 1.4 of EN 1990)			
	Characteristic	L/	300	-
	Frequent	L/	200	-
	Quasi-permanent	L/	200	-
	Cantilever limits - action combination (Table A 1.4 of EN 1990)			
	Characteristic	L _c /	150	-
	Frequent	L _c /	100	-
	Quasi-permanent	L _c /	100	-
	Vibration Design			
	Vibration design	$w_{rel,lim}$	5.0	mm
	Limitation of Web Breathing			
	<input type="checkbox"/> Design as steel bridge structure acc. to EN 1993-2, 7.4			

1.4 **FIRE RESISTANCE CONFIGURATIONS**

Config. No.	Name	Members	Assigned to		
			Member Sets	Shear Walls	Deep beams
1	Default	All	All	All	All

1.4.1 **FIRE RESISTANCE CONFIGURATIONS - SETTINGS**

Config. No.	Description	Symbol	Value	Unit
1	Default			
	Definition of Temperature			
	Define final temperature		Analytically	
	Fire design settings			
	Required time of fire resistance	$t_{f,req}$	45	min
	Fire exposure		All Sides	
	Time interval of analysis	Δt	5.000	s
	Fire protection			
	<input type="checkbox"/> Set fire protection parameters			





Monika Spajić
Jarunska ulica 2, 10000 Zagreb



Model:
DIPLOMSKI_03_09_2024
model

Date 11.9.2024 Page 4/9
Sheet 1

STEEL

1.4.1 FIRE RESISTANCE CONFIGURATIONS - SETTINGS

Config. No.	Description	Symbol	Value	Unit
	Temperature curve for determination of temperature of gases			
	Temperature curve			
	<input checked="" type="radio"/> Standard temperature-time curve <input type="radio"/> External fire curve <input type="radio"/> Hydrocarbon curve			
	Coefficient of heat transfer by convection	α_c	25	W·m ⁻² ·K ⁻¹
	Thermal actions for temperature analysis			
	Configuration factor	ϕ	1.000	-
	<input type="checkbox"/> Galvanized surface of carbon steel member			
	Surface emissivity of carbon steel member	ϵ_m	0.700	-
	Surface emissivity of stainless steel member	ϵ_m	0.400	-
	Emissivity of fire	ϵ_f	1.000	-

1.5 Results

1.5.1 DESIGN RATIOS ON MEMBERS BY SECTION

Steel Design

Section No.	Member No.	Location x [m]	Stress Point No.	Design Situation	Loading No.	Design Check Ratio η [-]	Type	Description
3	<input type="checkbox"/> SHS 100x100x5.000	100x100x5.000	9 - S355	DS1	CO1	0.000	SP0100.00	Section Proof Negligible internal forces
				DS1	CO1	0.001	SP1100.00	Section Proof Tension acc. to EN 1993-1-1, 6.2.3
				DS1	CO9	0.267	SP1200.00	Section Proof Compression acc. to EN 1993-1-1, 6.2.4
				DS1	CO14	0.005	SP4100.03	Section Proof Bending about y-axis acc. to EN 1993-1-1, 6.2.5 Plastic design
				DS1	CO6	0.003	SP5100.03	Section Proof Bending about z-axis acc. to EN 1993-1-1, 6.2.5 Plastic design
				DS1	CO14	0.000	SP6500.01	Section Proof Biaxial bending, axial force and shear acc. to EN 1993-1-1, 6.2.9.1 and 6.2.10 Plastic design
				DS1	CO30	0.003	SP6500.02	Section Proof Bending about y-axis, axial force and shear acc. to EN 1993-1-1, 6.2.9.1 and 6.2.10 Plastic design
				DS5	RC4	0.018	SP6500.03	Section Proof Bending about z-axis, axial force and shear acc. to EN 1993-1-1, 6.2.9.1 and 6.2.10 Plastic design
				DS5	RC1	0.000	SP6500.04	Section Proof Biaxial bending and shear acc. to EN 1993-1-1, 6.2.9.1 and 6.2.10 Plastic design
				DS1	CO9	0.756	ST1100.00	Stability Flexural buckling about principal y-axis acc. to EN 1993-1-1, 6.3.1
				DS1	CO9	0.756	ST1300.00	Stability Flexural buckling about principal z-axis acc. to EN 1993-1-1, 6.3.1
				DS1	CO9	0.075	ST3100.00	Stability Bending and buckling about principal axes acc. to EN 1993-1-1, 6.3.3
				DS2	CO43	0.000	SE0100.00	Serviceability Negligible deflections
				DS2	CO76	0.005	SE1100.00	Serviceability Deflections in z-direction
DS2	CO48	0.005	SE1200.00	Serviceability Deflections in y-direction				





Monika Spajić
Jarunska ulica 2, 10000 Zagreb



Model:
DIPLOMSKI_03_09_2024
model

Date 11.9.2024 Page 5/9
Sheet 1

MODEL

1.6 MEMBER NO. 33 | DS1 | CO9 | 0.000 M | SP1200

Steel Design

Design Check SP1200 | EN 1993 | CEN | 2015-06

Section Proof
Compression acc. to EN 1993-1-1, 6.2.4

$$N_{c,Rd} = A \cdot \frac{f_y}{\gamma_{M0}}$$

$$= 18.35 \text{ cm}^2 \cdot \frac{355.000 \text{ N/mm}^2}{1.00}$$

$$= 651.51 \text{ kN}$$

$$\eta_N = \frac{N_{c,Ed}}{N_{c,Rd}}$$

$$= \frac{173.93 \text{ kN}}{651.51 \text{ kN}}$$

$$= 0.267$$

$$\eta = \eta_N$$

$$= 0.267$$

$$\eta = 0.267 \leq 1 \quad \checkmark$$

- $N_{c,Rd}$ Design axial force resistance
- A Sectional area
- f_y Yield strength
- γ_{M0} Partial factor
- η_N Design component for N
- $N_{c,Ed}$ Design compression force

Eq. 6.10

6.2.4, Eq. 6.9





Monika Spajić
Jarunska ulica 2, 10000 Zagreb



Model:
DIPLOMSKI_03_09_2024
model

Date 11.9.2024 Page 6/9
Sheet 1

MODEL

1.7 MEMBER NO. 33 | DS1 | CO9 | 0.000 M | ST1300

Steel Design

Design Check ST1300 | EN 1993 | CEN | 2015-06

Stability
Flexural buckling about principal z-axis acc. to EN 1993-1-1, 6.3.1

$$N_{cr,z} = \frac{(\pi)^2 \cdot E \cdot I_z}{(L_{cr,z})^2}$$

$$= \frac{(\pi)^2 \cdot 210000.000 \text{ N/mm}^2 \cdot 271.02 \text{ cm}^4}{(4.080 \text{ m})^2}$$

$$= 337.44 \text{ kN}$$

$$\bar{\lambda}_z = \sqrt{\frac{A \cdot f_y}{N_{cr,z}}}$$

$$= \sqrt{\frac{18.35 \text{ cm}^2 \cdot 355.000 \text{ N/mm}^2}{337.44 \text{ kN}}}$$

$$= 1.390$$

$$\eta_{N_{cr,z}} = \gamma_{M1} \cdot \frac{N_{c,Ed}}{N_{cr,z}}$$

$$= 1.00 \cdot \frac{173.93 \text{ kN}}{337.44 \text{ kN}}$$

$$= 0.515$$

$$\Phi_z = 0.5 \cdot \left[1 + \alpha_z \cdot (\bar{\lambda}_z - 0.2) + (\bar{\lambda}_z)^2 \right]$$

$$= 0.5 \cdot \left[1 + 0.490 \cdot (1.390 - 0.2) + (1.390)^2 \right]$$

$$= 1.757$$

$$\chi_z = \frac{1}{\Phi_z + \sqrt{(\Phi_z)^2 - (\bar{\lambda}_z)^2}}$$

$$= \frac{1}{1.757 + \sqrt{(1.757)^2 - (1.390)^2}}$$

$$= 0.35$$

$$N_{b,z,Rd} = \chi_z \cdot A \cdot \frac{f_y}{\gamma_{M1}}$$

$$= 0.35 \cdot 18.35 \text{ cm}^2 \cdot \frac{355.000 \text{ N/mm}^2}{1.00}$$

$$= 230.07 \text{ kN}$$

$$\eta = \frac{N_{c,Ed}}{N_{b,z,Rd}}$$

$$= \frac{173.93 \text{ kN}}{230.07 \text{ kN}}$$

$$= 0.756$$

$\eta = 0.756 \leq 1$ ✓

- $N_{cr,z}$ Elastic critical force
- E Modulus of elasticity
- I_z Moment of inertia
- $L_{cr,z}$ Buckling length
- $\bar{\lambda}_z$ Non-dimensional slenderness
- A Sectional area
- f_y Yield strength
- $\eta_{N_{cr,z}}$ Criterion $N_{Ed} / N_{cr,z}$
- γ_{M1} Partial factor
- $N_{c,Ed}$ Design compression force
- Φ_z Value to determine reduction factor χ
- α_z Imperfection factor
- χ_z Reduction factor
- $N_{b,z,Rd}$ Design buckling resistance of a compression member

6.3.1.2(1)
6.3.1.3(1)
6.3.1.2(4)
6.3.1.2(1)
6.3.1.2(1), Eq. 6.49
6.3.1.1(3)
6.3.1





Monika Spajić
Jarunska ulica 2, 10000 Zagreb



Model:
DIPLOMSKI_03_09_2024
model

Date 11.9.2024 Page 8/9
Sheet 1

MODEL

1.8 MEMBER NO. 33 | DS1 | CO9 | 0.000 M | ST1100

Steel Design

Design Check ST1100 | EN 1993 | CEN | 2015-06

Stability
Flexural buckling about principal y-axis acc. to EN 1993-1-1, 6.3.1

$$N_{cr,y} = (\pi)^2 \cdot E \cdot \frac{I_y}{(l_{cr,y})^2}$$

$$= (\pi)^2 \cdot 210000.000 \text{ N/mm}^2 \cdot \frac{271.02 \text{ cm}^4}{(4.080 \text{ m})^2}$$

$$= 337.44 \text{ kN}$$

$$\bar{\lambda}_y = \sqrt{\frac{A \cdot f_y}{N_{cr,y}}}$$

$$= \sqrt{\frac{18.35 \text{ cm}^2 \cdot 355.000 \text{ N/mm}^2}{337.44 \text{ kN}}}$$

$$= 1.390$$

$$\eta_{N_{cr,y}} = \gamma_{M1} \cdot \frac{N_{c,Ed}}{N_{cr,y}}$$

$$= 1.00 \cdot \frac{173.93 \text{ kN}}{337.44 \text{ kN}}$$

$$= 0.515$$

$$\Phi_y = 0.5 \cdot \left[1 + \alpha_y \cdot (\bar{\lambda}_y - 0.2) + (\bar{\lambda}_y)^2 \right]$$

$$= 0.5 \cdot \left[1 + 0.490 \cdot (1.390 - 0.2) + (1.390)^2 \right]$$

$$= 1.757$$

$$\chi_y = \frac{1}{\Phi_y + \sqrt{(\Phi_y)^2 - (\bar{\lambda}_y)^2}}$$

$$= \frac{1}{1.757 + \sqrt{(1.757)^2 - (1.390)^2}}$$

$$= 0.35$$

$$N_{b,y,Rd} = \chi_y \cdot A \cdot \frac{f_y}{\gamma_{M1}}$$

$$= 0.35 \cdot 18.35 \text{ cm}^2 \cdot \frac{355.000 \text{ N/mm}^2}{1.00}$$

$$= 230.07 \text{ kN}$$

$$\eta = \frac{N_{c,Ed}}{N_{b,y,Rd}}$$

$$= \frac{173.93 \text{ kN}}{230.07 \text{ kN}}$$

$$= 0.756$$

$\eta = 0.756 \leq 1$ ✓

- $N_{cr,y}$ Elastic critical force
- E Modulus of elasticity
- I_y Moment of inertia
- $l_{cr,y}$ Buckling length
- $\bar{\lambda}_y$ Non-dimensional slenderness
- A Sectional area
- f_y Yield strength
- $\eta_{N_{cr,y}}$ Criterion $N_{Ed} / N_{cr,y}$
- γ_{M1} Partial factor
- $N_{c,Ed}$ Design compression force
- Φ_y Value to determine reduction factor χ
- α_y Imperfection factor
- χ_y Reduction factor for buckling
- $N_{b,y,Rd}$ Design buckling resistance of a compression member

6.3.1.2(1)

6.3.1.3(1)

6.3.1.2(4)

6.3.1.2(1)

6.3.1.2(1), Eq. 6.49

6.3.1.1(3)

6.3.1



3.6. Dimenzioniranje CLT panela (d=22 cm) – Stora Enso

3.6.1. Dimenzioniranje međukatne konstrukcije – kontinuirana ploča preko 2 raspona



Diplomski rad
Međukatna ploča
Monika Spajić

1/12
08/09/2024

System

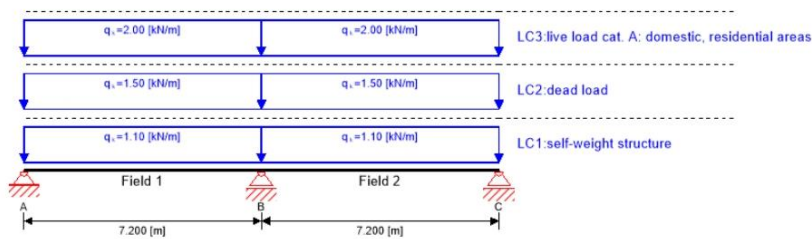

Global utilization ratio

99%

ULS 33% ULS Fire 26% SLS 56% Vibration 99% Support 10%

Product data

Section: CLT 220 L7s - 2

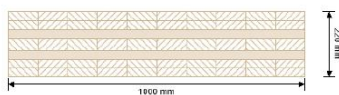

Layer	Thickness	Orientation	Material
1	30.0 mm	0°	C24 spruce ETA (2022)
2	30.0 mm	0°	C24 spruce ETA (2022)
3	30.0 mm	90°	C24 spruce ETA (2022)
4	40.0 mm	0°	C24 spruce ETA (2022)
5	30.0 mm	90°	C24 spruce ETA (2022)
6	30.0 mm	0°	C24 spruce ETA (2022)
7	30.0 mm	0°	C24 spruce ETA (2022)
t_{CLT}	220.0 mm		

Section Fire: CLT 220 L7s - 2

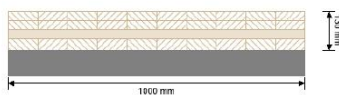

Layer	Thickness	Orientation	Material
1	30.0 mm	0°	C24 spruce ETA (2022)
2	30.0 mm	0°	C24 spruce ETA (2022)
3	30.0 mm	90°	C24 spruce ETA (2022)
4	40.0 mm	0°	C24 spruce ETA (2022)
t_{CLT}	130.0 mm		



Diplomski rad
Međukatna ploča
Monika Spajić

2/12
08/09/2024

Section Fire: CLT 220 L7s - 2

Fire resistance class: R 90

Time **90 min**

Fire protection layering:
no additional fire protection

k_0	d_0	$d_{char,0,h}$	$d_{ef,h}$	$d_{char,0,v}$	$d_{ef,v}$
[-]	[mm]	[mm]	[mm]	[mm]	[mm]
1	7	82.0	89.0	0.0	0.0

Material values

Material	$f_{m,k}$	$f_{t0,k}$	$f_{t,90,k}$	$f_{c,0,k}$	$f_{c,90,k}$	$f_{v,k}$	$f_{r,k \text{ min}}$	$E_{0,mean}$	G_{mean}	$G_{r,mean}$
	[N/mm ²]	[N/mm ²]	[N/mm ²]	[N/mm ²]	[N/mm ²]	[N/mm ²]	[N/mm ²]	[N/mm ²]	[N/mm ²]	[N/mm ²]
C24 spruce ETA (2022)	24.00	14.00	0.12	21.00	2.50	4.00	1.25	12,000.00	690.00	50.00

Load

Load case groups

Load case category	Type	Duration	K_{mod}	γ_{inf}	γ_{sup}	ψ_0	ψ_1	ψ_2
LC1 self-weight structure	G	permanent	0.6	1	1.35	1	1	1
LC2 dead load	G	permanent	0.6	1	1.35	1	1	1
LC3 live load cat. A: domestic, residential areas	Q	medium term	0.8	0	1.5	0.7	0.5	0.3

LC1: self-weight structure

continuous load

Field	Load at start
	[kN/m]
1	1.10
2	1.10

LC2: dead load



Diplomski rad
Međukatna ploča
Monika Spajić

3/12
08/09/2024

continuous load

Field	Load at start [kN/m]
1	1.50
2	1.50

LC3: live load cat. A: domestic, residential areas

continuous load

Field	Load at start [kN/m]
1	2.00
2	2.00

ULS Combinations

	Combination rule
LC01	$1.35/1.00 * LC1 + 1.35/1.00 * LC2$
LC02	$1.35/1.00 * LC1 + 1.35/1.00 * LC2 + 1.50/0.00 * LC3$

ULS Combinations Fire

	Combination rule
LC03	$1.00/1.00 * LC1 + 1.00/1.00 * LC2$
LC04	$1.00/1.00 * LC1 + 1.00/1.00 * LC2 + 1.00/0.00 * 0.30 * LC3$

SLS Characteristic Combination

	Combination rule
LC05	$1.00/1.00 * LC1 + 1.00/1.00 * LC2$
LC06	$1.00/1.00 * LC1 + 1.00/1.00 * LC2 + 1.00/0.00 * LC3$

SLS Quasi-permanent Combination

	Combination rule
LC07	$1.00/1.00 * LC1 + 1.00/1.00 * LC2$



Diplomski rad
 Međukatna ploča
 Monika Spajić

4/12
 08/09/2024

SLS Quasi-permanent Combination

Combination rule

LCO8 $1.00/1.00 * LC1 + 1.00/1.00 * LC2 + 1.00/0.00 * 0.30 * LC3$

Ultimate limit state (ULS) - design results

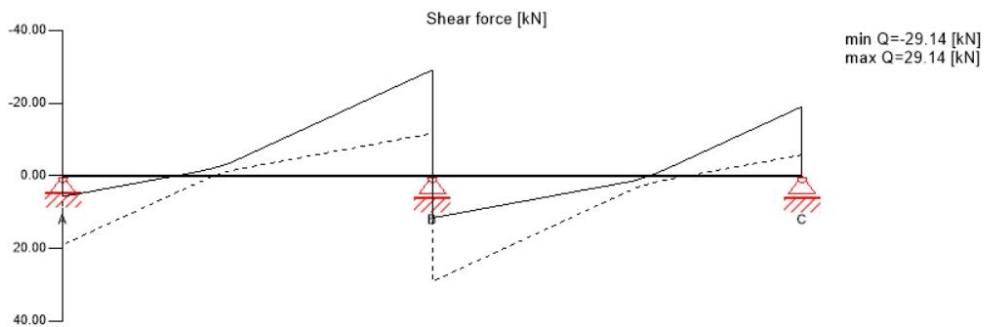
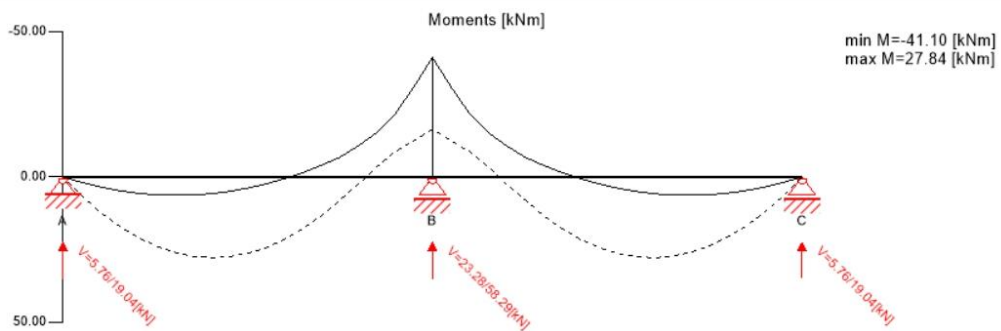

ULS Flexural design

Field	Dist. [m]	$f_{m,k}$ [N/mm ²]	γ_m [-]	k_{mod} [-]	$k_{sys,y}$ [-]	$f_{m,y,d}$ [N/mm ²]	$M_{y,d}$ [kNm]	$\sigma_{m,y,d}$ [N/mm ²]	Ratio	
1	7.2	24.00	1.25	0.80	1.10	16.90	-41.10	5.59	33%	LCO2
2	0.0	24.00	1.25	0.80	1.10	16.90	-41.10	5.59	33%	LCO2

© 2024 - Calculatis by Stora Enso - Version 7.10.0
 Any use of results of the software is only allowed, if the results have been verified and approved regarding completeness and correctness by a project structural/building physics engineer. For more information see the Terms of Use.



Diplomski rad
 Međukatna ploča
 Monika Spajić

5/12
 08/09/2024

ULS Shear analysis

Field	Dist. [m]	$f_{v,k}$ [N/mm ²]	γ_m [-]	k_{mod} [-]	$f_{v,d}$ [N/mm ²]	V_d [kN]	$\tau_{v,d}$ [N/mm ²]	Ratio	
1	7.2	4.00	1.25	0.80	2.56	-29.14	0.18	7%	LCO2
2	0.0	4.00	1.25	0.80	2.56	29.14	0.18	7%	LCO2

ULS Rolling shear

Field	Dist. [m]	$f_{r,k}$ [N/mm ²]	γ_m [-]	k_{mod} [-]	$f_{r,d}$ [N/mm ²]	V_d [kN]	$\tau_{r,d}$ [N/mm ²]	Ratio	
1	7.2	1.15	1.25	0.80	0.74	-29.14	0.17	23%	LCO2
2	0.0	1.15	1.25	0.80	0.74	29.14	0.17	23%	LCO2

Stress diagram

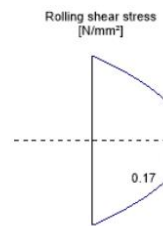
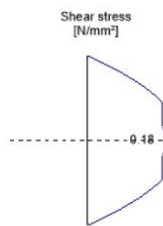
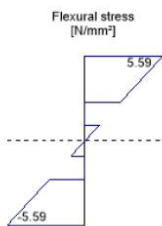



Diplomski rad
 Međukatna ploča
 Monika Spajić

6/12
 08/09/2024

Flexural stress analysis					
$M_{y,d}$	=	-41.10	kNm	$f_{m,k}$	= 24.00 N/mm ²
$M_{z,d}$	=	0.00	kNm	$f_{m,k,z}$	= 24.00 N/mm ²
$N_{t,d}$	=	0.00	kN	γ_m	= 1.25 -
				K_{mod}	= 0.80 -
				$K_{sys,y}$	= 1.10 -
				$k_{h,m,y}$	= 1.00 -
				$k_{h,m,z}$	= 1.00 -
				k_i	= 1.00 -
$\sigma_{t,d}$	=	0.00	N/mm ²	$f_{t,0,d}$	= 8.96 N/mm ²
$\sigma_{m,y,d}$	=	5.59	N/mm ²	$f_{m,y,d}$	= 16.90 N/mm ²
$\sigma_{m,z,d}$	=	0.00	N/mm ² <	$f_{m,z,d}$	= 0.00 N/mm ² ✓
Utilization ratio					33%
Shear stress analysis					
V_d	=	-29.14	kN	$f_{v,k}$	= 4.00 N/mm ²
				γ_m	= 1.25 -
				K_{mod}	= 0.80 -
				$k_{h,v}$	= 0.00 -
$\tau_{v,d}$	=	0.18	N/mm ² <	$f_{v,d}$	= 2.56 N/mm ² ✓
Utilization ratio					7%
Rolling shear analysis					
V_d	=	-29.14	kN	$f_{r,k}$	= 1.15 N/mm ²
				γ_m	= 1.25 -
				K_{mod}	= 0.80 -
$\tau_{r,d}$	=	0.17	N/mm ² <	$f_{r,d}$	= 0.74 N/mm ² ✓
Utilization ratio					23%

© 2024 - Calculatis by Stora Enso - Version 7.10.0
 Any use of results of the software is only allowed, if the results have been verified and approved regarding completeness and correctness by a project structural/building physics engineer. For more information see the Terms of Use.



Diplomski rad
 Međukatna ploča
 Monika Spajić

7/12
 08/09/2024

Ultimate limit state (ULS) fire design - results

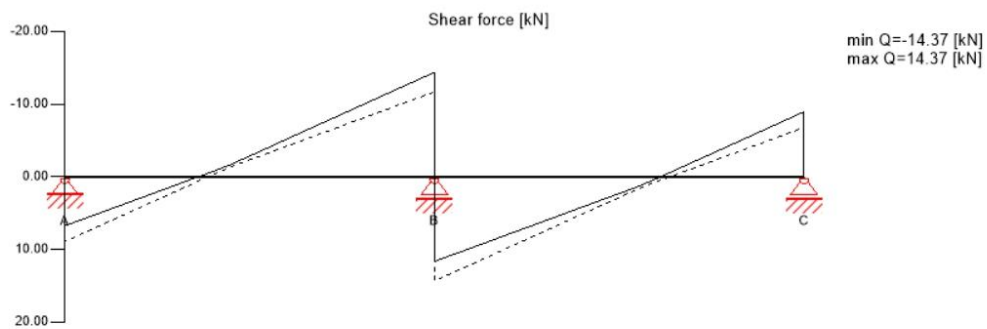
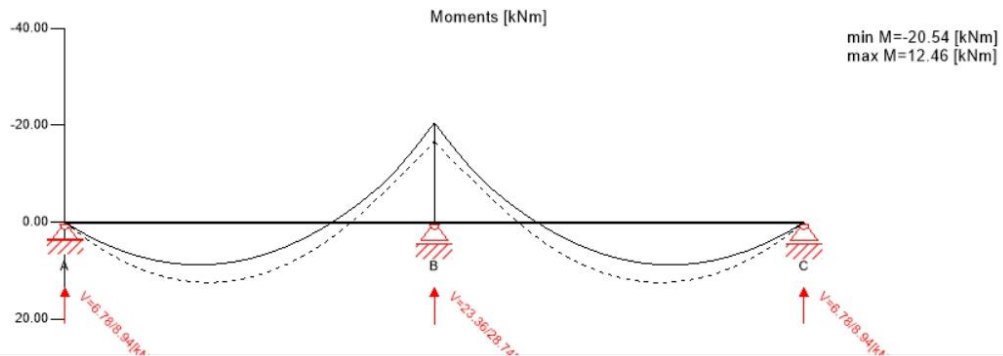

ULS Fire Flexural design

Field	Dist.	$f_{m,k}$	γ_m	k_{mod}	$k_{sys,y}$	k_{fi}	$f_{m,y,d}$	$M_{y,d}$	$\sigma_{m,y,d}$	Ratio	
	[m]	[N/mm ²]	[-]	[-]	[-]	[-]	[N/mm ²]	[kNm]	[N/mm ²]		
1	7.2	24.00	1.00	1.00	1.10	1.15	30.36	-20.54	-7.89	26%	LCO4
2	0.0	24.00	1.00	1.00	1.10	1.15	30.36	-20.54	-7.89	26%	LCO4

ULS Fire Shear analysis

Field	Dist.	$f_{v,k}$	γ_m	k_{mod}	k_{fi}	$f_{v,d}$	V_d	$\tau_{v,d}$	Ratio	
	[m]	[N/mm ²]	[-]	[-]	[-]	[N/mm ²]	[kN]	[N/mm ²]		
1	7.2	4.00	1.00	1.00	1.15	4.60	-14.37	0.16	3%	LCO4
2	0.0	4.00	1.00	1.00	1.15	4.60	14.37	0.16	3%	LCO4

© 2024 - Calculatis by Stora Enso - Version 7.10.0
 Any use of results of the software is only allowed, if the results have been verified and approved regarding completeness and correctness by a project structural/building physics engineer. For more information see the Terms of Use.



Diplomski rad
 Međukatna ploča
 Monika Spajić

8/12
 08/09/2024

ULS Fire Rolling shear

Field	Dist. [m]	$f_{r,k}$ [N/mm ²]	γ_m [-]	k_{mod} [-]	k_{ff} [-]	$f_{r,d}$ [N/mm ²]	V_d [kN]	$T_{r,d}$ [N/mm ²]	Ratio	
1	7.2	1.15	1.00	1.00	1.15	1.32	-14.37	0.16	12%	LCO4
2	0.0	1.15	1.00	1.00	1.15	1.32	14.37	0.16	12%	LCO4

Stress diagram

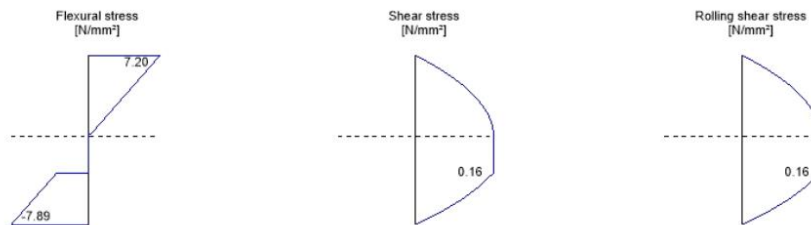

Flexural stress analysis Fire

$M_{y,d} =$	-20.54	kNm	$f_{m,k} =$	24.00	N/mm ²
$M_{z,d} =$	0.00	kNm	$f_{m,k,z} =$	24.00	N/mm ²
$N_{l,d} =$	0.00	kN	$\gamma_m =$	1.00	-
			$k_{mod} =$	1.00	-
			$k_{sys,y} =$	1.10	-
			$k_{h,m,y} =$	1.00	-
			$k_{h,m,z} =$	1.00	-
			$k_1 =$	1.00	-
			$k_{ff} =$	1.15	-
$\sigma_{t,d} =$	0.00	N/mm ²	$f_{t,0,d} =$	16.10	N/mm ²
$\sigma_{m,y,d} =$	-7.89	N/mm ²	$f_{m,y,d} =$	30.36	N/mm ²
$\sigma_{m,z,d} =$	0.00	N/mm ²	$f_{m,z,d} =$	0.00	N/mm ² ✓

Utilization ratio

26%



Diplomski rad
 Međukatna ploča
 Monika Spajić

9/12
 08/09/2024

Shear stress analysis Fire					
$V_d =$	-14.37	kN	$f_{v,k} =$	4.00	N/mm ²
			$\gamma_m =$	1.00	-
			$k_{mod} =$	1.00	-
			$k_{h,v} =$	0.00	-
			$k_{fl} =$	1.15	-
$T_{v,d} =$	0.16	N/mm ²	$f_{v,d} =$	4.60	N/mm ² ✓
Utilization ratio					3%

Rolling shear analysis Fire					
$V_d =$	-14.37	kN	$f_{r,k} =$	1.15	N/mm ²
			$\gamma_m =$	1.00	-
			$k_{mod} =$	1.00	-
			$k_{fl} =$	1.15	-
$T_{r,d} =$	0.16	N/mm ²	$f_{r,d} =$	1.32	N/mm ² ✓
Utilization ratio					12%

Service limit state design (SLS) - design results

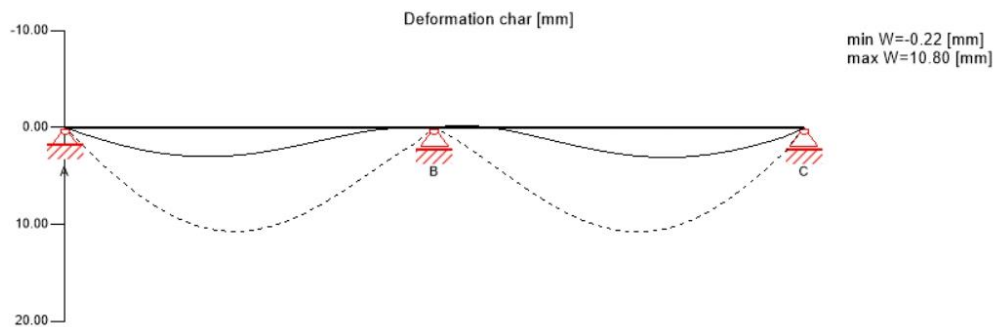

© 2024 - Calculatis by Stora Enso - Version 7.10.0
 Any use of results of the software is only allowed, if the results have been verified and approved regarding completeness and correctness by a project structural/building physics engineer. For more information see the Terms of Use.



Diplomski rad
 Međukatna ploča
 Monika Spajić

10/12
 08/09/2024

Service limit state design (SLS) - design results

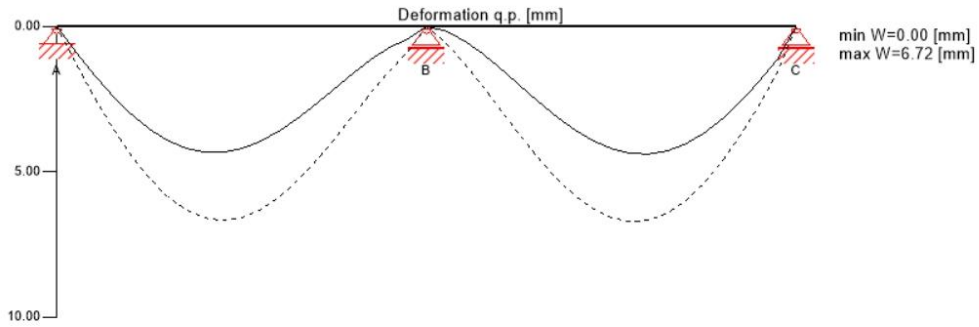

$w_{inst} = w[char]$

Field	K_{def}	Limit	w_{limit}	$w_{calc.}$	Ratio
		[-]	[mm]	[mm]	
1	0.8	L/300	24.0	10.7	45%
2	0.8	L/300	24.0	10.8	45%

$w_{fin} = w[char] + w[q.p.] * k_{def}$

Field	K_{def}	Limit	w_{limit}	$w_{calc.}$	Ratio
		[-]	[mm]	[mm]	
1	0.8	L/250	28.8	16.1	56%
2	0.8	L/250	28.8	16.2	56%

$w_{net,fin} = w[q.p.] + w[q.p.] * k_{def}$

Field	K_{def}	Limit	w_{limit}	$w_{calc.}$	Ratio
		[-]	[mm]	[mm]	
1	0.8	L/300	24.0	12.0	50%
2	0.8	L/300	24.0	12.1	50%

© 2024 - Calculatis by Stora Enso - Version 7.10.0
 Any use of results of the software is only allowed, if the results have been verified and approved regarding completeness and correctness by a project structural/building physics engineer. For more information see the Terms of Use.



Diplomski rad
 Međukatna ploča
 Monika Spajić

11/12
 08/09/2024

Vibration analysis

General

Total mass	38.17 [t]
Tributary width	3.6 [m]
Stiffness Longitudinal direction	9712.0 [kNm ²]
Stiffness Cross direction	936.0 [kNm ²]
Modal damping	4.0 [%]
α	0.1 [-]
Man weight	700.0 [N]
Modal mass	6947.8 [kg]

Analysis

Criterion	Calc.	Class I	Class II	Class I	Class II	Cl. I	Cl. II
Frequency criterion min	5.802 [Hz]	4.5 [Hz]	4.5 [Hz]	78 %	78 %	✓	✓
Frequency criterion	5.802 [Hz]	8.0 [Hz]	6.0 [Hz]	138 %	103 %		
Acceleration criterion	0.049 [m/s ²]	0.05 [m/s ²]	0.1 [m/s ²]	99 %	49 %	✓	✓
Stiffness criterion	0.22 [mm]	0.25 [mm]	0.5 [mm]	88 %	44 %	✓	✓

Support design

Nr.	Type	Width [mm]	Area [cm ²]	k_{mod} [-]	γ_m [-]	$k_{c,90}$ [-]	$f_{c,k}$ [N/mm ²]	$f_{c,d}$ [N/mm ²]	V_{max} [kN]	V_{min} [kN]	$\sigma_{c,90,d}$ [N/mm ²]	Ratio
A	Rigid plate	140	1700.00	0.80	1.25	1.50	2.50	2.40	19.04	0.00	0.11	LCO2 5%
B	Rigid plate	140	2000.00	0.80	1.25	1.80	2.50	2.88	58.29	0.00	0.29	LCO2 10%
C	Rigid plate	140	1700.00	0.80	1.25	1.50	2.50	2.40	19.04	0.00	0.11	LCO2 5%

Support reaction

Load case category	k_{mod}	A_V	B_V	C_V
			[kN]	
self-weight structure	0.6	3.00	9.85	3.00
		3.00	9.85	3.00
dead load	0.6	4.08	13.43	4.08
		4.08	13.43	4.08
live load cat. A: domestic, residential areas	0.8	6.32	17.91	6.32
		-0.88	0.00	-0.88

Reference documents for this analysis

English title	Description
EN 338	EN 338 - Structural timber ? Strength classes



Diplomski rad
Međukatna ploča
Monika Spajić

12/12
08/09/2024

Reference documents for this analysis

English title	Description
EN 1995-1-1	EN 1995-1-1 - Eurocode 5: Design of timber structures - Part 1-1: General - Common rules and rules for buildings
ETA-14/0349	European Technical Assessment ETA-14/0349
Expertise Rolling shear - no edge gluing, H.J. Blass	Expertise on Rolling shear for CLT
EN 1995-1-2	EN 1995-1-2 - Eurocode 5 — Design of timber structures — Part 1-2: General — Structural fire design
Technical expertise 122/2011/02: analysis of load bearing capacity and separation performance of CLT elements	Verification of the load bearing capacity and the insulation criterion of CLT structures with Stora Enso CLT
Technical expertise 2434/2012 - BB: failure time of gypsum fire boards (GKF) according to ON B 3410	Expertise on failure time of gypsum wall fire boards according to ON B3410 and gypsum wall boards type DF according to EN 520
EN 1990	EN 1990 - Eurocode 5: Basis of structural design
ÖNorm B 1995-1-1 NA	ÖNORM EN 1995-1-1 - Austria - National Annex – Nationally determined parameters – Eurocode 5: Design of timber structures – Part 1-1: General-Common rules and rules for buildings
ÖNorm B 1995-1-2 NA	ÖNORM EN 1995-1-2 - Austria - National Annex - Eurocode 5: Design of timber structures ? Part 1-2: General ? Structural fire design ? National specifications concerning ÖNORM EN 1995-1-2, national comments and national supplements
Fire safety in timber buildings - technical guideline for Europe	Fire safety in timber buildings - technical guideline for Europe; publishes by SP Technical Research Institute of Sweden
National specifications concerning ÖNORM EN 1995-1-2, national comments and national supplements, chapter 12	ÖNORM EN 1995-1-2 - National specifications concerning ÖNORM EN 1995-1-2, national comments and national supplements, chapter 12
Expertise Rolling shear, H.J. Blass	Expertise on rolling shear strength and rolling shear modulus of CLT panels
ÖNORM EN 1995-1-1_NA, chapter 7.3	ÖNORM EN 1995-1-1 - Austria - National Annex – Nationally determined parameters – Eurocode 5: Design of timber structures – Part 1-1: General-Common rules and rules for buildings; chapter 7.3

Disclaimer

The software was created to assist engineers in their daily business. The software is an engineering software that is dealing with a very complex matter of structural analysis and building physics analysis. Therefore, this software shall only be operated by skilled, experienced engineers, with a deep understanding of structural engineering and building physics related to timber structures. The user of the software is obliged to check all input values, no matter if they were given by the user or given by default by the software and all results for plausibility. The use of the results of the software should not be relied upon as the basis for any decision or action. Any use of results of the software is only allowed, if the results have been verified and approved regarding completeness and correctness by a project structural/building physics engineer. The user has the possibility to make print-outs from the software. Any modification of those are not allowed. Stora Enso Wood Products GmbH does not assume any warranty regarding the software. The software has been developed with utmost diligence, nevertheless Stora Enso Wood Products GmbH, neither expressly nor implicitly, provides any warranty in terms of accuracy, validity, timeliness and completeness of information and data created by the software. Stora Enso Wood Products GmbH does also not assume any warranty for the general usability of the software, its suitability for a special purpose or for the compatibility of the software with the ones of third party producers or providers. Stora Enso Wood Products GmbH is only liable for damages caused by gross negligence or intent through Stora Enso Wood Products GmbH; the liability for slight negligence is excluded. This does not apply to personal injury. Under the aforementioned conditions Stora Enso Wood Products GmbH is as well not liable for operational failures or the loss of programs and/or data of the user's data processing system. Applicable Law: These terms of use shall be governed by the laws of Austria excluding however any conflict of laws rules and any laws regarding the Convention of the International Sale of Goods (CISG).

© 2024 - Calculatis by Stora Enso - Version 7.10.0

Any use of results of the software is only allowed, if the results have been verified and approved regarding completeness and correctness by a project structural/building physics engineer. For more information see the Terms of Use.



3.6.2. Dimenzioniranje međukatne konstrukcije – konzola



Diplomski rad
 Međukatna ploča - konzola
 Monika Spajić

1/12
 08/09/2024

System

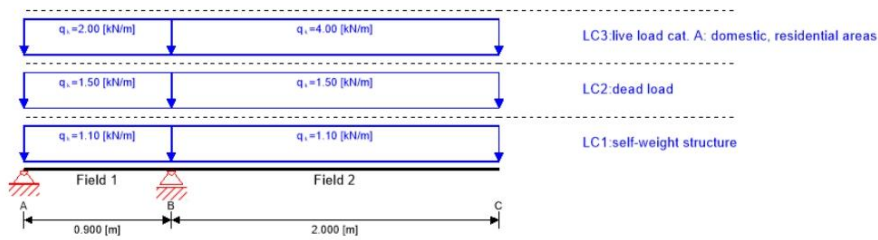

Global utilization ratio

38%

ULS 19% ULS Fire 10% SLS 38% Vibration 21% Support 7%

Product data

Section: CLT 220 L7s - 2

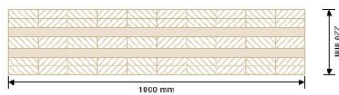

Layer	Thickness	Orientation	Material
1	30.0 mm	0°	C24 spruce ETA (2022)
2	30.0 mm	0°	C24 spruce ETA (2022)
3	30.0 mm	90°	C24 spruce ETA (2022)
4	40.0 mm	0°	C24 spruce ETA (2022)
5	30.0 mm	90°	C24 spruce ETA (2022)
6	30.0 mm	0°	C24 spruce ETA (2022)
7	30.0 mm	0°	C24 spruce ETA (2022)
t_{CLT}	220.0 mm		

Section Fire: CLT 220 L7s - 2

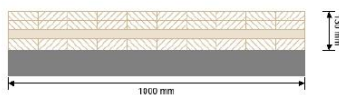

Layer	Thickness	Orientation	Material
1	30.0 mm	0°	C24 spruce ETA (2022)
2	30.0 mm	0°	C24 spruce ETA (2022)
3	30.0 mm	90°	C24 spruce ETA (2022)
4	40.0 mm	0°	C24 spruce ETA (2022)
t_{CLT}	130.0 mm		

© 2024 - Calculatis by Stora Enso - Version 7.10.0
 Any use of results of the software is only allowed, if the results have been verified and approved regarding completeness and correctness by a project structural/building physics engineer. For more information see the Terms of Use.



Diplomski rad
Međukatna ploča - konzola
Monika Spajić

2/12
08/09/2024

Section Fire: CLT 220 L7s - 2

Fire resistance class: R 90

Time **90 min**

Fire protection layering:
no additional fire protection

k_0	d_0	$d_{char,0,h}$	$d_{ef,h}$	$d_{char,0,v}$	$d_{ef,v}$
[-]	[mm]	[mm]	[mm]	[mm]	[mm]
1	7	82.0	89.0	0.0	0.0

Material values

Material	$f_{m,k}$	$f_{t0,k}$	$f_{t,90,k}$	$f_{c,0,k}$	$f_{c,90,k}$	$f_{v,k}$	$f_{r,k \min}$	$E_{0,mean}$	G_{mean}	$G_{r,mean}$
	[N/mm ²]	[N/mm ²]	[N/mm ²]	[N/mm ²]	[N/mm ²]	[N/mm ²]	[N/mm ²]	[N/mm ²]	[N/mm ²]	[N/mm ²]
C24 spruce ETA (2022)	24.00	14.00	0.12	21.00	2.50	4.00	1.25	12,000.00	690.00	50.00

Load

Load case groups

Load case category	Type	Duration	K_{mod}	γ_{inf}	γ_{sup}	ψ_0	ψ_1	ψ_2
LC1 self-weight structure	G	permanent	0.6	1	1.35	1	1	1
LC2 dead load	G	permanent	0.6	1	1.35	1	1	1
LC3 live load cat. A: domestic, residential areas	Q	medium term	0.8	0	1.5	0.7	0.5	0.3

LC1: self-weight structure

continuous load

Field	Load at start
	[kN/m]
1	1.10
2	1.10

LC2: dead load



Diplomski rad
Međukatna ploča - konzola
Monika Spajić

3/12
08/09/2024

continuous load

Field	Load at start [kN/m]
1	1.50
2	1.50

LC3:live load cat. A: domestic, residential areas

continuous load

Field	Load at start [kN/m]
1	2.00
2	4.00

ULS Combinations

	Combination rule
LC01	$1.35/1.00 * LC1 + 1.35/1.00 * LC2$
LC02	$1.35/1.00 * LC1 + 1.35/1.00 * LC2 + 1.50/0.00 * LC3$

ULS Combinations Fire

	Combination rule
LC03	$1.00/1.00 * LC1 + 1.00/1.00 * LC2$
LC04	$1.00/1.00 * LC1 + 1.00/1.00 * LC2 + 1.00/0.00 * 0.30 * LC3$

SLS Characteristic Combination

	Combination rule
LC05	$1.00/1.00 * LC1 + 1.00/1.00 * LC2$
LC06	$1.00/1.00 * LC1 + 1.00/1.00 * LC2 + 1.00/0.00 * LC3$

SLS Quasi-permanent Combination

	Combination rule
LC07	$1.00/1.00 * LC1 + 1.00/1.00 * LC2$



Diplomski rad
 Međukatna ploča - konzola
 Monika Spajić

4/12
 08/09/2024

SLS Quasi-permanent Combination

Combination rule

LCO8 1.00/1.00 * LC1 + 1.00/1.00 * LC2 + 1.00/0.00 * 0.30 * LC3

Ultimate limit state (ULS) - design results

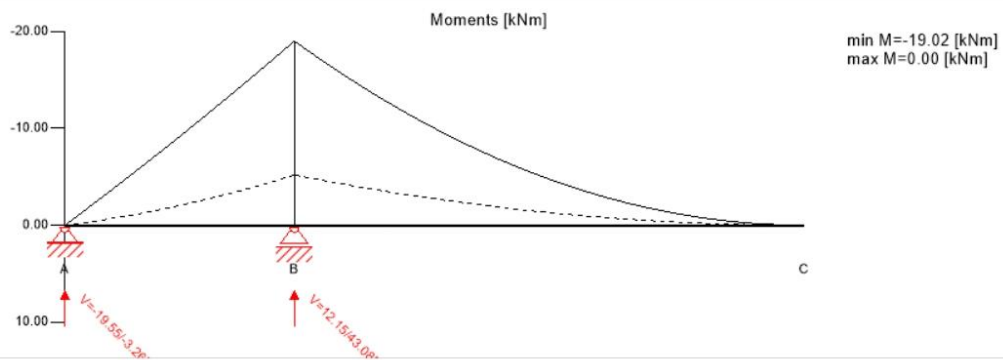

ULS Flexural design

Field	Dist.	$f_{m,k}$	γ_m	k_{mod}	$k_{sys,y}$	$f_{m,y,d}$	$M_{y,d}$	$\sigma_{m,y,d}$	Ratio	
	[m]	[N/mm ²]	[-]	[-]	[-]	[N/mm ²]	[kNm]	[N/mm ²]		
1	0.9	24.00	1.25	0.80	1.10	16.90	-19.02	2.59	15%	LCO2
2	0.0	24.00	1.25	0.80	1.10	16.90	-19.02	2.59	15%	LCO2

© 2024 - Calculatis by Stora Enso - Version 7.10.0
 Any use of results of the software is only allowed, if the results have been verified and approved regarding completeness and correctness by a project structural/building physics engineer. For more information see the Terms of Use.



Diplomski rad
 Međukatna ploča - konzola
 Monika Spajić

5/12
 08/09/2024

ULS Shear analysis

Field	Dist. [m]	$f_{v,k}$ [N/mm ²]	γ_m [-]	k_{mod} [-]	$f_{v,d}$ [N/mm ²]	V_d [kN]	$\tau_{v,d}$ [N/mm ²]	Ratio	
1	0.9	4.00	1.25	0.80	2.56	-24.06	0.15	6%	LCO2
2	0.0	4.00	1.25	0.80	2.56	19.02	0.12	5%	LCO2

ULS Rolling shear

Field	Dist. [m]	$f_{r,k}$ [N/mm ²]	γ_m [-]	k_{mod} [-]	$f_{r,d}$ [N/mm ²]	V_d [kN]	$\tau_{r,d}$ [N/mm ²]	Ratio	
1	0.9	1.15	1.25	0.80	0.74	-24.06	0.14	19%	LCO2
2	0.0	1.15	1.25	0.80	0.74	19.02	0.11	15%	LCO2

Stress diagram

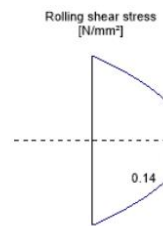
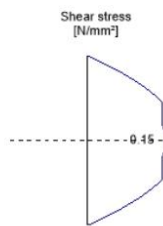
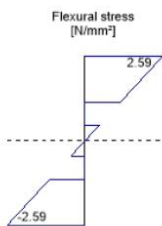



Diplomski rad
Međukatna ploča - konzola
Monika Spajić

6/12
08/09/2024

Flexural stress analysis					
$M_{y,d}$ =	-19.02	kNm	$f_{m,k}$ =	24.00	N/mm ²
$M_{z,d}$ =	0.00	kNm	$f_{m,k,z}$ =	24.00	N/mm ²
$N_{t,d}$ =	0.00	kN	γ_m =	1.25	-
			K_{mod} =	0.80	-
			$K_{sys,y}$ =	1.10	-
			$K_{h,m,y}$ =	1.00	-
			$K_{h,m,z}$ =	1.00	-
			k_t =	1.00	-
$\sigma_{t,d}$ =	0.00	N/mm ²	$f_{t,0,d}$ =	8.96	N/mm ²
$\sigma_{m,y,d}$ =	2.59	N/mm ²	$f_{m,y,d}$ =	16.90	N/mm ²
$\sigma_{m,z,d}$ =	0.00	N/mm ²	$f_{m,z,d}$ =	0.00	N/mm ² ✓
Utilization ratio					15%
Shear stress analysis					
V_d =	-24.06	kN	$f_{v,k}$ =	4.00	N/mm ²
			γ_m =	1.25	-
			K_{mod} =	0.80	-
			$K_{h,v}$ =	0.00	-
$\tau_{v,d}$ =	0.15	N/mm ²	$f_{v,d}$ =	2.56	N/mm ² ✓
Utilization ratio					6%
Rolling shear analysis					
V_d =	-24.06	kN	$f_{r,k}$ =	1.15	N/mm ²
			γ_m =	1.25	-
			K_{mod} =	0.80	-
$\tau_{r,d}$ =	0.14	N/mm ²	$f_{r,d}$ =	0.74	N/mm ² ✓
Utilization ratio					19%



Diplomski rad
 Međukatna ploča - konzola
 Monika Spajić

7/12
 08/09/2024

Ultimate limit state (ULS) fire design - results

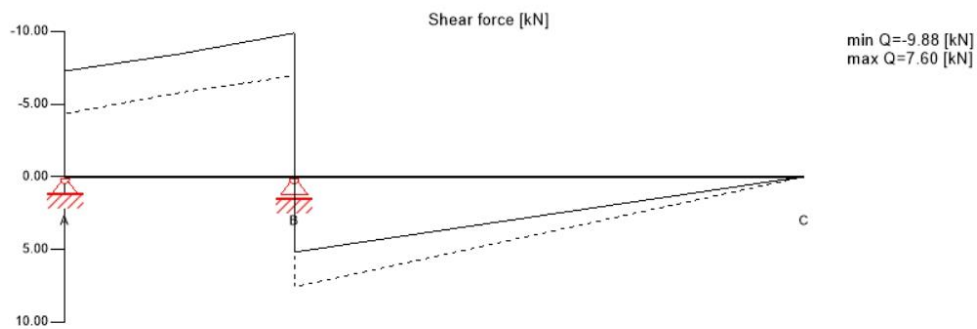
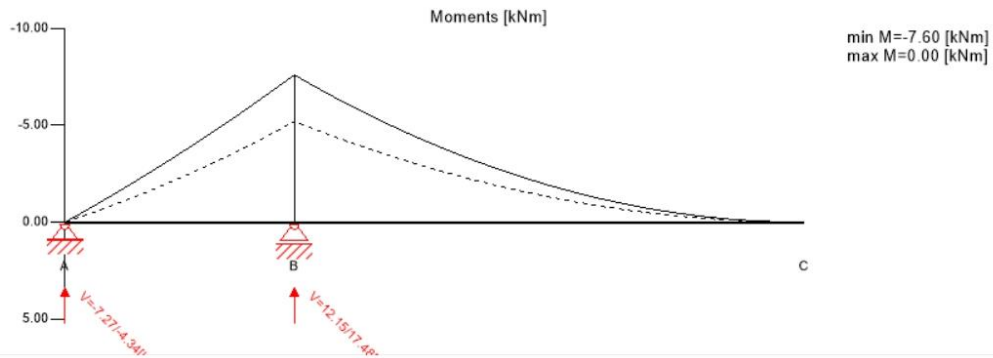

ULS Fire Flexural design

Field	Dist. [m]	$f_{m,k}$ [N/mm ²]	γ_m [-]	k_{mod} [-]	$k_{sys,y}$ [-]	k_{fi} [-]	$f_{m,y,d}$ [N/mm ²]	$M_{y,d}$ [kNm]	$\sigma_{m,y,d}$ [N/mm ²]	Ratio	
1	0.9	24.00	1.00	1.00	1.10	1.15	30.36	-7.60	-2.92	10%	LCO4
2	0.0	24.00	1.00	1.00	1.10	1.15	30.36	-7.60	-2.92	10%	LCO4

ULS Fire Shear analysis

Field	Dist. [m]	$f_{v,k}$ [N/mm ²]	γ_m [-]	k_{mod} [-]	k_{fi} [-]	$f_{v,d}$ [N/mm ²]	V_d [kN]	$\tau_{v,d}$ [N/mm ²]	Ratio	
1	0.9	4.00	1.00	1.00	1.15	4.60	-9.88	0.11	2%	LCO4
2	0.0	4.00	1.00	1.00	1.15	4.60	7.60	0.08	2%	LCO4

© 2024 - Calculatis by Stora Enso - Version 7.10.0
 Any use of results of the software is only allowed, if the results have been verified and approved regarding completeness and correctness by a project structural/building physics engineer. For more information see the Terms of Use.



Diplomski rad
 Međukatna ploča - konzola
 Monika Spajić

8/12
 08/09/2024

ULS Fire Rolling shear

Field	Dist. [m]	$f_{r,k}$ [N/mm ²]	γ_m [-]	k_{mod} [-]	k_{ff} [-]	$f_{r,d}$ [N/mm ²]	V_d [kN]	$T_{r,d}$ [N/mm ²]	Ratio	
1	0.9	1.15	1.00	1.00	1.15	1.32	-9.88	0.11	8%	LCO4
2	0.0	1.15	1.00	1.00	1.15	1.32	7.60	0.08	6%	LCO4

Stress diagram

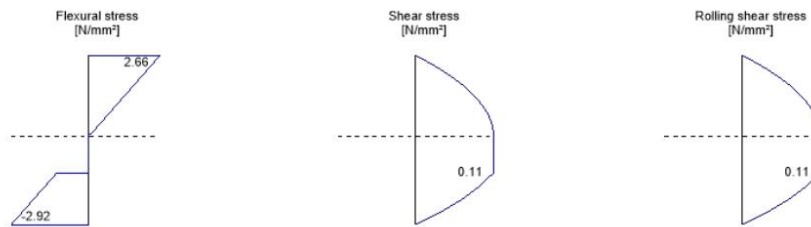

Flexural stress analysis Fire

$M_{y,d} =$	-7.60	kNm	$f_{m,k} =$	24.00	N/mm ²
$M_{z,d} =$	0.00	kNm	$f_{m,k,z} =$	24.00	N/mm ²
$N_{l,d} =$	0.00	kN	$\gamma_m =$	1.00	-
			$k_{mod} =$	1.00	-
			$k_{sys,y} =$	1.10	-
			$k_{h,m,y} =$	1.00	-
			$k_{h,m,z} =$	1.00	-
			$k_1 =$	1.00	-
			$k_{ff} =$	1.15	-
$\sigma_{t,d} =$	0.00	N/mm ²	$f_{t,0,d} =$	16.10	N/mm ²
$\sigma_{m,y,d} =$	-2.92	N/mm ²	$f_{m,y,d} =$	30.36	N/mm ²
$\sigma_{m,z,d} =$	0.00	N/mm ²	$f_{m,z,d} =$	0.00	N/mm ² ✓

Utilization ratio

10%



Diplomski rad
 Međukatna ploča - konzola
 Monika Spajić

9/12
 08/09/2024

Shear stress analysis Fire					
$V_d =$	-9.88	kN	$f_{v,k} =$	4.00	N/mm ²
			$\gamma_m =$	1.00	-
			$k_{mod} =$	1.00	-
			$k_{h,v} =$	0.00	-
			$k_{fl} =$	1.15	-
$T_{v,d} =$	0.11	N/mm ²	$f_{v,d} =$	4.60	N/mm ² ✓
Utilization ratio					2%

Rolling shear analysis Fire					
$V_d =$	-9.88	kN	$f_{r,k} =$	1.15	N/mm ²
			$\gamma_m =$	1.00	-
			$k_{mod} =$	1.00	-
			$k_{fl} =$	1.15	-
$T_{r,d} =$	0.11	N/mm ²	$f_{r,d} =$	1.32	N/mm ² ✓
Utilization ratio					8%

Service limit state design (SLS) - design results

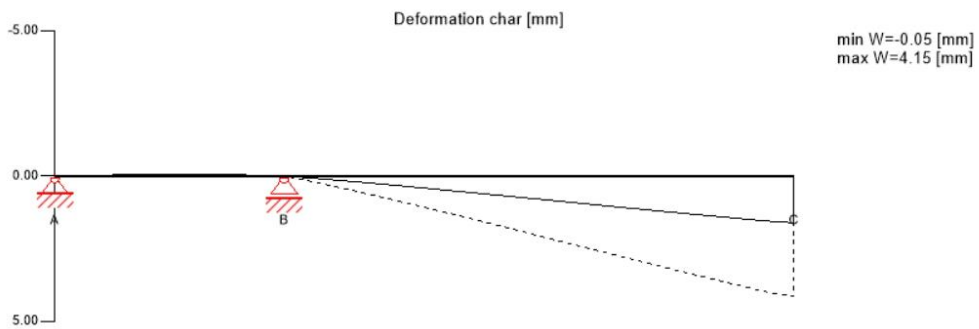

© 2024 - Calculatis by Stora Enso - Version 7.10.0
 Any use of results of the software is only allowed, if the results have been verified and approved regarding completeness and correctness by a project structural/building physics engineer. For more information see the Terms of Use.



Diplomski rad
 Međukatna ploča - konzola
 Monika Spajić

10/12
 08/09/2024

Service limit state design (SLS) - design results

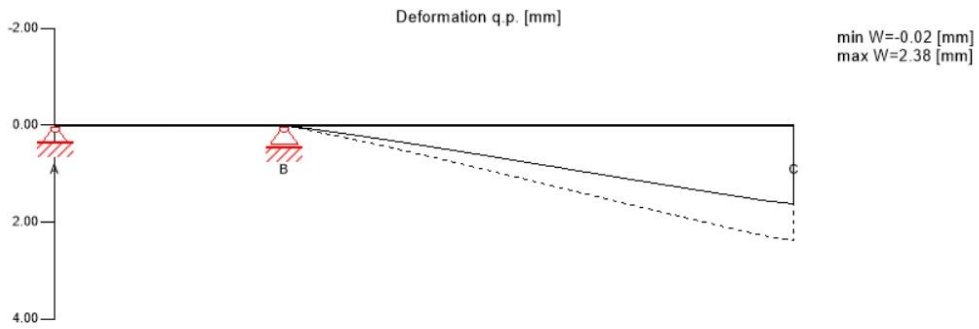

w_{inst} = w[char]

Field	K _{def}	Limit	w _{limit}	w _{calc.}	Ratio
		[-]	[mm]	[mm]	
1	0.8	L/300	3.0	0.0	0%
2	0.8	L/300	13.3	4.1	31%

w_{fin} = w[char] + w[q.p.]*k_{def}

Field	K _{def}	Limit	w _{limit}	w _{calc.}	Ratio
		[-]	[mm]	[mm]	
1	0.8	L/250	3.6	0.0	0%
2	0.8	L/250	16.0	6.1	38%

w_{net,fin} = w[q.p.] + w[q.p.]*k_{def}

Field	K _{def}	Limit	w _{limit}	w _{calc.}	Ratio
		[-]	[mm]	[mm]	
1	0.8	L/300	3.0	0.0	0%
2	0.8	L/300	13.3	4.3	32%

© 2024 - Calculatis by Stora Enso - Version 7.10.0
 Any use of results of the software is only allowed, if the results have been verified and approved regarding completeness and correctness by a project structural/building physics engineer. For more information see the Terms of Use.



Diplomski rad
Međukatna ploča - konzola
Monika Spajić

11/12
08/09/2024

Vibration analysis

General

Total mass	2.23 [t]
Tributary width	1.0 [m]
Stiffness Longitudinal direction	9712.0 [kNm ²]
Stiffness Cross direction	936.0 [kNm ²]
Modal damping	4.0 [%]
α	0.0 [-]
Man weight	700.0 [N]
Modal mass	148.5 [kg]

Analysis

Criterion	Calc.	Class I	Class II	Class I	Class II	Cl. I	Cl. II
Frequency criterion min	21.118 [Hz]	4.5 [Hz]	4.5 [Hz]	21 %	21 %	✓	✓
Frequency criterion	21.118 [Hz]	8.0 [Hz]	6.0 [Hz]	38 %	28 %		
Acceleration criterion	0.005 [m/s ²]	0.05 [m/s ²]	0.1 [m/s ²]	10 %	5 %		
Stiffness criterion	0.017 [mm]	0.25 [mm]	0.5 [mm]	7 %	3 %	✓	✓

Support design

Nr.	Type	Width [mm]	Area [cm ²]	k_{mod} [-]	γ_m [-]	$k_{c,90}$ [-]	$f_{c,k}$ [N/mm ²]	$f_{c,d}$ [N/mm ²]	V_{max} [kN]	V_{min} [kN]	$\sigma_{c,90,d}$ [N/mm ²]	Ratio
A	Rigid plate	140	1700.00	0.60	1.25	1.50	2.50	1.80	0.00	-6.22	0.00	LCO1 0%
B	Rigid plate	140	2000.00	0.80	1.25	1.80	2.50	2.88	43.08	0.00	0.22	LCO2 7%

Support reaction

Load case category	k_{mod}	A_V	B_V
		[kN]	
self-weight structure	0.6	-1.95	5.14
		-1.95	5.14
dead load	0.6	-2.66	7.01
		-2.66	7.01
live load cat. A: domestic, residential areas	0.8	0.90	17.79
		-8.89	0.00

Reference documents for this analysis

English title	Description
EN 338	EN 338 - Structural timber ? Strength classes
EN 1995-1-1	EN 1995-1-1 - Eurocode 5: Design of timber structures - Part 1-1: General - Common rules and rules for buildings



Diplomski rad
Međukatna ploča - konzola
Monika Spajić

12/12
08/09/2024

Reference documents for this analysis

English title	Description
ETA-14/0349	European Technical Assessment ETA-14/0349
Expertise Rolling shear - no edge gluing, H.J. Blass	Expertise on Rolling shear for CLT
EN 1995-1-2	EN 1995-1-2 - Eurocode 5 — Design of timber structures — Part 1-2: General — Structural fire design
Technical expertise 122/2011/02: analysis of load bearing capacity and separation performance of CLT elements	Verification of the load bearing capacity and the insulation criterion of CLT structures with Stora Enso CLT
Technical expertise 2434/2012 - BB: failure time t_f of gypsum fire boards (GKF) according to ON B 3410	Expertise on failure time t_f of gypsum wall fire boards according to ON B3410 and gypsum wall boards type DF according to EN 520
EN 1990	EN 1990 - Eurocode 0 Basis of structural design
ÖNorm B 1995-1-1 NA	ÖNORM EN 1995-1-1 - Austria - National Annex – Nationally determined parameters – Eurocode 5: Design of timber structures – Part 1-1: General-Common rules and rules for buildings
ÖNorm B 1995-1-2 NA	ÖNORM EN 1995-1-2 - Austria - National Annex - Eurocode 5: Design of timber structures ? Part 1-2: General ? Structural fire design ? National specifications concerning ÖNORM EN 1995-1-2, national comments and national supplements
Fire safety in timber buildings - technical guideline for Europe	Fire safety in timber buildings - technical guideline for Europe; publishes by SP Technical Research Institute of Sweden
National specifications concerning ÖNORM EN 1995-1-2, national comments and national supplements, chapter 12	ÖNORM EN 1995-1-2 - National specifications concerning ÖNORM EN 1995-1-2, national comments and national supplements, chapter 12
Expertise Rolling shear, H.J. Blass	Expertise on rolling shear strength and rolling shear modulus of CLT panels
ÖNORM EN 1995-1-1_NA, chapter 7.3	ÖNORM EN 1995-1-1 - Austria - National Annex – Nationally determined parameters – Eurocode 5: Design of timber structures – Part 1-1: General-Common rules and rules for buildings; chapter 7.3

Disclaimer

The software was created to assist engineers in their daily business. The software is an engineering software that is dealing with a very complex matter of structural analysis and building physics analysis. Therefore, this software shall only be operated by skilled, experienced engineers, with a deep understanding of structural engineering and building physics related to timber structures. The user of the software is obliged to check all input values, no matter if they were given by the user or given by default by the software and all results for plausibility. The use of the results of the software should not be relied upon as the basis for any decision or action. Any use of results of the software is only allowed, if the results have been verified and approved regarding completeness and correctness by a project structural/building physics engineer. The user has the possibility to make print-outs from the software. Any modification of those are not allowed. Stora Enso Wood Products GmbH does not assume any warranty regarding the software. The software has been developed with utmost diligence, nevertheless Stora Enso Wood Products GmbH, neither expressly nor implicitly, provides any warranty in terms of accuracy, validity, timeliness and completeness of information and data created by the software. Stora Enso Wood Products GmbH does also not assume any warranty for the general usability of the software, its suitability for a special purpose or for the compatibility of the software with the ones of third party producers or providers. Stora Enso Wood Products GmbH is only liable for damages caused by gross negligence or intent through Stora Enso Wood Products GmbH; the liability for slight negligence is excluded. This does not apply to personal injury. Under the aforementioned conditions Stora Enso Wood Products GmbH is as well not liable for operational failures or the loss of programs and/or data of the user's data processing system. Applicable Law: These terms of use shall be governed by the laws of Austria excluding however any conflict of laws rules and any laws regarding the Convention of the International Sale of Goods (CISG).

© 2024 - Calculatis by Stora Enso - Version 7.10.0

Any use of results of the software is only allowed, if the results have been verified and approved regarding completeness and correctness by a project structural/building physics engineer. For more information see the Terms of Use.

3.6.3. Dimenzioniranje krovne ploče



Diplomski_ploča
Krovna ploča
Monika Spajić

1/13
10/09/2024

System

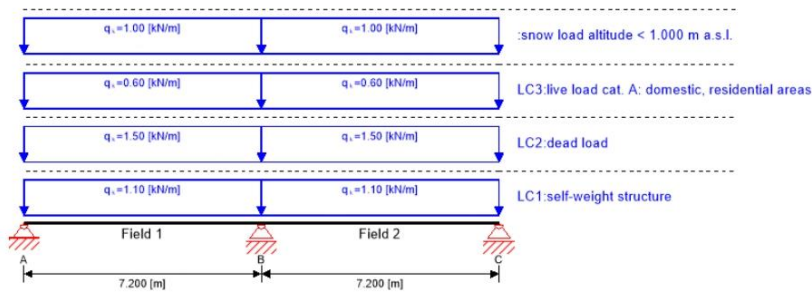

Global utilization ratio

99%

ULS 25% ULS Fire 23% SLS 43% Vibration 99% Support 8%

Product data

Section: CLT 220 L7s - 2

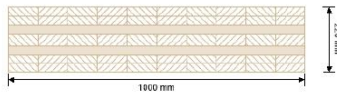

Layer	Thickness	Orientation	Material
1	30.0 mm	0°	C24 spruce ETA (2022)
2	30.0 mm	0°	C24 spruce ETA (2022)
3	30.0 mm	90°	C24 spruce ETA (2022)
4	40.0 mm	0°	C24 spruce ETA (2022)
5	30.0 mm	90°	C24 spruce ETA (2022)
6	30.0 mm	0°	C24 spruce ETA (2022)
7	30.0 mm	0°	C24 spruce ETA (2022)
t_{CLT}	220.0 mm		



Diplomski ploča
Krovna ploča
Monika Spajić

2/13
10/09/2024

Section Fire: CLT 220 L7s - 2

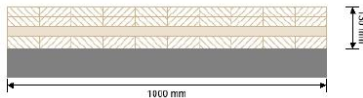

Layer	Thickness	Orientation	Material
1	30.0 mm	0°	C24 spruce ETA (2022)
2	30.0 mm	0°	C24 spruce ETA (2022)
3	30.0 mm	90°	C24 spruce ETA (2022)
4	40.0 mm	0°	C24 spruce ETA (2022)

t_{CLT} **130.0 mm**

Fire resistance class: R 90

Time **90 min**

Fire protection layering:
no additional fire protection

k_0	d_0	$d_{char,0,h}$	$d_{ef,h}$	$d_{char,0,v}$	$d_{ef,v}$
[-]	[mm]	[mm]	[mm]	[mm]	[mm]
1	7	82.0	89.0	0.0	0.0

Material values

Material	$f_{m,k}$	$f_{t0,k}$	$f_{t90,k}$	$f_{c0,k}$	$f_{c90,k}$	$f_{v,k}$	$f_{r,k \text{ min}}$	$E_{0, \text{mean}}$	G_{mean}	$G_{r, \text{mean}}$
	[N/mm ²]	[N/mm ²]	[N/mm ²]	[N/mm ²]	[N/mm ²]	[N/mm ²]	[N/mm ²]	[N/mm ²]	[N/mm ²]	[N/mm ²]
C24 spruce ETA (2022)	24.00	14.00	0.12	21.00	2.50	4.00	1.25	12,000.00	690.00	50.00

Load

Load case groups

Load case category	Type	Duration	K_{mod}	γ_{inf}	γ_{sup}	Ψ_0	Ψ_1	Ψ_2
LC1 self-weight structure	G	permanent	0.6	1	1.35	1	1	1
LC2 dead load	G	permanent	0.6	1	1.35	1	1	1
LC3 live load cat. A: domestic, residential areas	Q	medium term	0.8	0	1.5	0.7	0.5	0.3
snow load altitude < 1.000 m a.s.l.	Q	short term	0.9	0	1.5	0.5	0.2	0

LC1: self-weight structure

continuous load

Field	Load at start
	[kN/m]
1	1.10



Diplomski ploča
Krovna ploča
Monika Spajić

3/13
10/09/2024

continuous load

Field	Load at start [kN/m]
2	1.10

LC2: dead load

continuous load

Field	Load at start [kN/m]
1	1.50
2	1.50

LC3: live load cat. A: domestic, residential areas

continuous load

Field	Load at start [kN/m]
1	0.60
2	0.60

:snow load altitude < 1.000 m a.s.l.

continuous load

Field	Load at start [kN/m]
1	1.00
2	1.00



Diplomski_ploča
Krovna ploča
Monika Spajić

4/13
10/09/2024

ULS Combinations

	Combination rule
LCO1	$1.35/1.00 * LC1 + 1.35/1.00 * LC2$
LCO2	$1.35/1.00 * LC1 + 1.35/1.00 * LC2 + 1.50/0.00 * LC3$
LCO3	$1.35/1.00 * LC1 + 1.35/1.00 * LC2 + 1.50/0.00 * LC3 + 1.50/0.00 * 0.50 *$
LCO4	$1.35/1.00 * LC1 + 1.35/1.00 * LC2 + 1.50/0.00 *$
LCO5	$1.35/1.00 * LC1 + 1.35/1.00 * LC2 + 1.50/0.00 * + 1.50/0.00 * 0.70 * LC3$

ULS Combinations Fire

	Combination rule
LCO6	$1.00/1.00 * LC1 + 1.00/1.00 * LC2$
LCO7	$1.00/1.00 * LC1 + 1.00/1.00 * LC2 + 1.00/0.00 * 0.30 * LC3$
LCO8	$1.00/1.00 * LC1 + 1.00/1.00 * LC2 + 1.00/0.00 * 0.30 * LC3 + 1.00/0.00 * 0.00 *$
LCO9	$1.00/1.00 * LC1 + 1.00/1.00 * LC2 + 1.00/0.00 * 0.00 *$
LCO10	$1.00/1.00 * LC1 + 1.00/1.00 * LC2 + 1.00/0.00 * 0.00 * + 1.00/0.00 * 0.30 * LC3$

SLS Characteristic Combination

	Combination rule
LCO11	$1.00/1.00 * LC1 + 1.00/1.00 * LC2$
LCO12	$1.00/1.00 * LC1 + 1.00/1.00 * LC2 + 1.00/0.00 * LC3 + 1.00/0.00 * 0.50 *$
LCO13	$1.00/1.00 * LC1 + 1.00/1.00 * LC2 + 1.00/0.00 * + 1.00/0.00 * 0.70 * LC3$

SLS Quasi-permanent Combination

	Combination rule
LCO14	$1.00/1.00 * LC1 + 1.00/1.00 * LC2$
LCO15	$1.00/1.00 * LC1 + 1.00/1.00 * LC2 + 1.00/0.00 * 0.30 * LC3 + 1.00/0.00 * 0.00 *$
LCO16	$1.00/1.00 * LC1 + 1.00/1.00 * LC2 + 1.00/0.00 * 0.00 * + 1.00/0.00 * 0.30 * LC3$



Diplomski_ploča
Krovna ploča
Monika Spajić

5/13
10/09/2024

Ultimate limit state (ULS) - design results

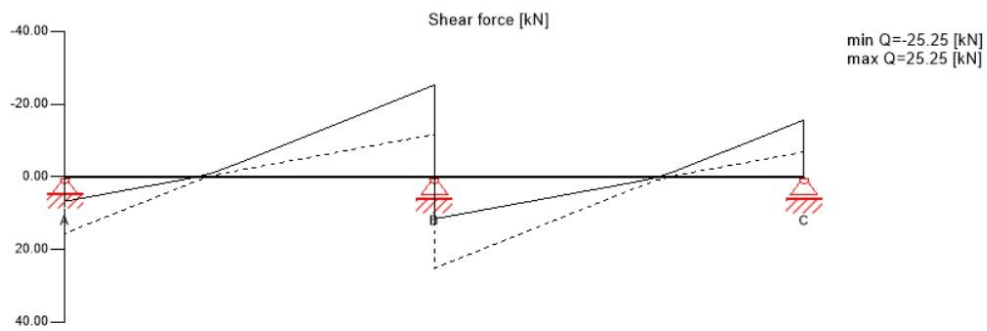
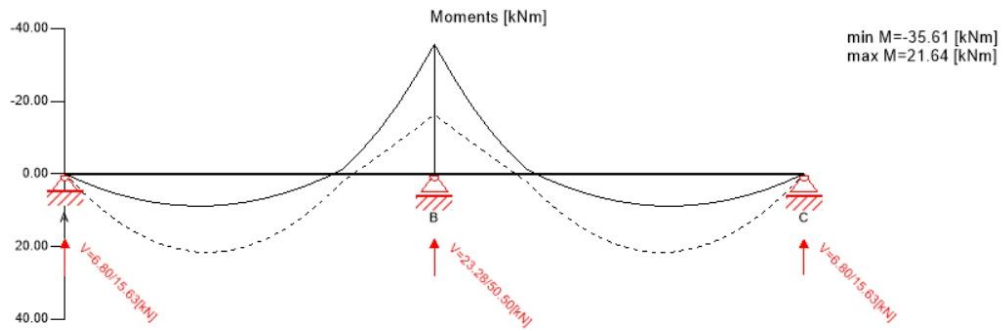

ULS Flexural design

Field	Dist.	$f_{m,k}$	γ_m	k_{mod}	$k_{sys,y}$	$f_{m,y,d}$	$M_{y,d}$	$\sigma_{m,y,d}$	Ratio	
	[m]	[N/mm ²]	[-]	[-]	[-]	[N/mm ²]	[kNm]	[N/mm ²]		
1	7.2	24.00	1.25	0.90	1.10	19.01	-35.61	4.84	25%	LCO5
2	0.0	24.00	1.25	0.90	1.10	19.01	-35.61	4.84	25%	LCO5

ULS Shear analysis

Field	Dist.	$f_{v,k}$	γ_m	k_{mod}	$f_{v,d}$	V_d	$\tau_{v,d}$	Ratio	
	[m]	[N/mm ²]	[-]	[-]	[N/mm ²]	[kN]	[N/mm ²]		
1	7.2	4.00	1.25	0.90	2.88	-25.25	0.16	5%	LCO5
2	0.0	4.00	1.25	0.90	2.88	25.25	0.16	5%	LCO5

© 2024 - Calculatis by Stora Enso - Version 7.10.0
Any use of results of the software is only allowed, if the results have been verified and approved regarding completeness and correctness by a project structural/building physics engineer. For more information see the Terms of Use.



Diplomski ploča
Kont_2_polja_krovna
Monika Spajić

Domusplus

2
Austria
Checker

6/13
10/09/2024

ULS Rolling shear

Field	Dist. [m]	$f_{r,k}$ [N/mm ²]	γ_m [-]	K_{mod} [-]	$f_{r,d}$ [N/mm ²]	V_d [kN]	$\tau_{r,d}$ [N/mm ²]	Ratio	
1	7.2	1.15	1.25	0.90	0.83	-25.25	0.15	18%	LCO5
2	0.0	1.15	1.25	0.90	0.83	25.25	0.15	18%	LCO5

Stress diagram

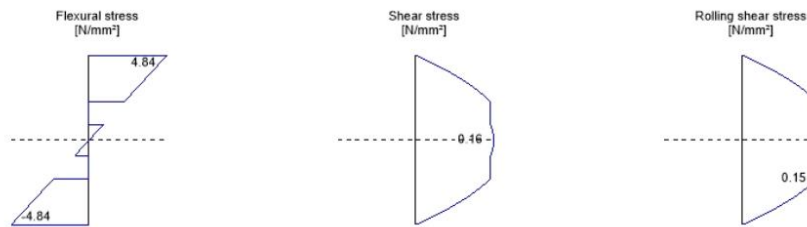

Flexural stress analysis

$M_{y,d} =$	-35.61	kNm	$f_{m,k} =$	24.00	N/mm ²
$M_{z,d} =$	0.00	kNm	$f_{m,k,z} =$	24.00	N/mm ²
$N_{l,d} =$	0.00	kN	$\gamma_m =$	1.25	-
			$K_{mod} =$	0.90	-
			$k_{sys,y} =$	1.10	-
			$K_{h,m,y} =$	1.00	-
			$K_{h,m,z} =$	1.00	-
			$K_1 =$	1.00	-
$\sigma_{t,d} =$	0.00	N/mm ²	$f_{t,0,d} =$	10.08	N/mm ²
$\sigma_{m,y,d} =$	4.84	N/mm ²	$f_{m,y,d} =$	19.01	N/mm ²
$\sigma_{m,z,d} =$	0.00	N/mm ²	$f_{m,z,d} =$	0.00	N/mm ² ✓
Utilization ratio					25%



Diplomski_ploča
Krovna ploča
Monika Spajić

7/13
10/09/2024

Shear stress analysis					
$V_d =$	-25.25	kN	$f_{v,k} =$	4.00	N/mm ²
			$Y_m =$	1.25	-
			$K_{mod} =$	0.90	-
			$K_{h,v} =$	0.00	-
$T_{v,d} =$	0.16	N/mm ²	$f_{v,d} =$	2.88	N/mm ² ✓
Utilization ratio					5%

Rolling shear analysis					
$V_d =$	-25.25	kN	$f_{r,k} =$	1.15	N/mm ²
			$Y_m =$	1.25	-
			$K_{mod} =$	0.90	-
$T_{r,d} =$	0.15	N/mm ²	$f_{r,d} =$	0.83	N/mm ² ✓
Utilization ratio					18%

Ultimate limit state (ULS) fire design - results

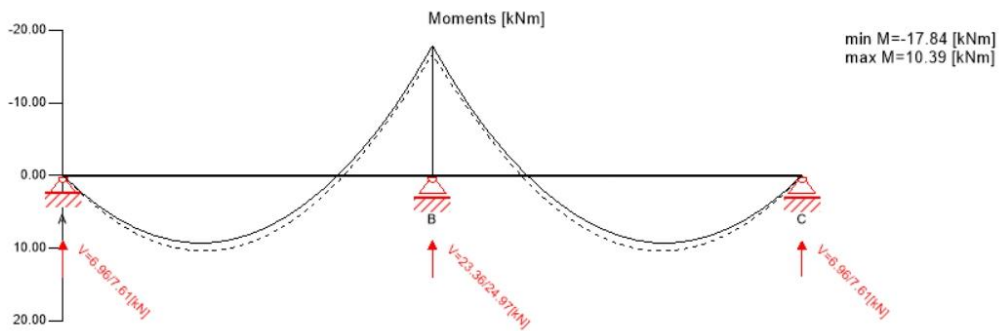

© 2024 - Calculatis by Stora Enso - Version 7.10.0
Any use of results of the software is only allowed, if the results have been verified and approved regarding completeness and correctness by a project structural/building physics engineer. For more information see the Terms of Use.



Diplomski_ploča
Krovna ploča
Monika Spajić

8/13
10/09/2024

Ultimate limit state (ULS) fire design - results

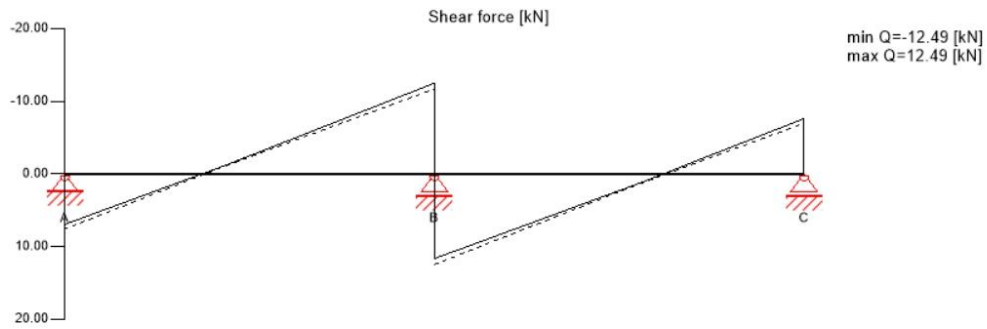

ULS Fire Flexural design

Field	Dist.	$f_{m,k}$	γ_m	k_{mod}	$k_{sys,y}$	k_{fi}	$f_{m,y,d}$	$M_{y,d}$	$\sigma_{m,y,d}$	Ratio	
	[m]	[N/mm ²]	[-]	[-]	[-]	[-]	[N/mm ²]	[kNm]	[N/mm ²]		
1	7.2	24.00	1.00	1.00	1.10	1.15	30.36	-17.84	-6.86	23%	LCO7
2	0.0	24.00	1.00	1.00	1.10	1.15	30.36	-17.84	-6.86	23%	LCO7

ULS Fire Shear analysis

Field	Dist.	$f_{v,k}$	γ_m	k_{mod}	k_{fi}	$f_{v,d}$	V_d	$\tau_{v,d}$	Ratio	
	[m]	[N/mm ²]	[-]	[-]	[-]	[N/mm ²]	[kN]	[N/mm ²]		
1	7.2	4.00	1.00	1.00	1.15	4.60	-12.49	0.14	3%	LCO7
2	0.0	4.00	1.00	1.00	1.15	4.60	12.49	0.14	3%	LCO7

ULS Fire Rolling shear

Field	Dist.	$f_{r,k}$	γ_m	k_{mod}	k_{fi}	$f_{r,d}$	V_d	$\tau_{r,d}$	Ratio	
	[m]	[N/mm ²]	[-]	[-]	[-]	[N/mm ²]	[kN]	[N/mm ²]		
1	7.2	1.15	1.00	1.00	1.15	1.32	-12.49	0.14	10%	LCO7
2	0.0	1.15	1.00	1.00	1.15	1.32	12.49	0.14	10%	LCO7



Diplomski ploča
Krovna ploča
Monika Spajić

9/13
10/09/2024

Stress diagram

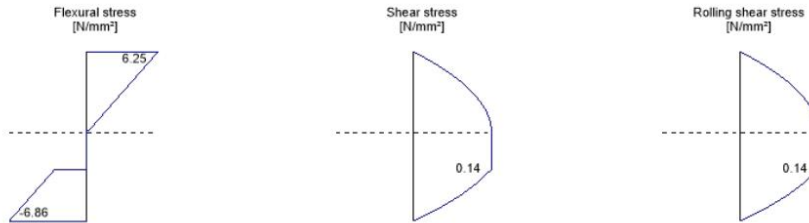

Flexural stress analysis Fire

$M_{y,d}$	=	-17.84	kNm	$f_{m,k}$	=	24.00	N/mm ²
$M_{z,d}$	=	0.00	kNm	$f_{m,k,z}$	=	24.00	N/mm ²
$N_{t,d}$	=	0.00	kN	γ_m	=	1.00	-
				k_{mod}	=	1.00	-
				$k_{sys,y}$	=	1.10	-
				$k_{h,m,y}$	=	1.00	-
				$k_{h,m,z}$	=	1.00	-
				k_i	=	1.00	-
				k_{β}	=	1.15	-
$\sigma_{t,d}$	=	0.00	N/mm ²	$f_{t,0,d}$	=	16.10	N/mm ²
$\sigma_{m,y,d}$	=	-6.86	N/mm ²	$f_{m,y,d}$	=	30.36	N/mm ²
$\sigma_{m,z,d}$	=	0.00	N/mm ²	$f_{m,z,d}$	=	0.00	N/mm ² ✓
Utilization ratio							23%



Diplomski ploča
Krovna ploča
Monika Spajić

10/13
10/09/2024

Shear stress analysis Fire

$V_d =$	-12.49	kN	$f_{v,k} =$	4.00	N/mm ²
			$\gamma_m =$	1.00	-
			$k_{mod} =$	1.00	-
			$k_{h,v} =$	0.00	-
			$k_{fl} =$	1.15	-
$T_{v,d} =$	0.14	N/mm ²	$f_{v,d} =$	4.60	N/mm ² ✓

Utilization ratio

3%

Rolling shear analysis Fire

$V_d =$	-12.49	kN	$f_{r,k} =$	1.15	N/mm ²
			$\gamma_m =$	1.00	-
			$k_{mod} =$	1.00	-
			$k_{fl} =$	1.15	-
$T_{r,d} =$	0.14	N/mm ²	$f_{r,d} =$	1.32	N/mm ² ✓

Utilization ratio

10%

Service limit state design (SLS) - design results

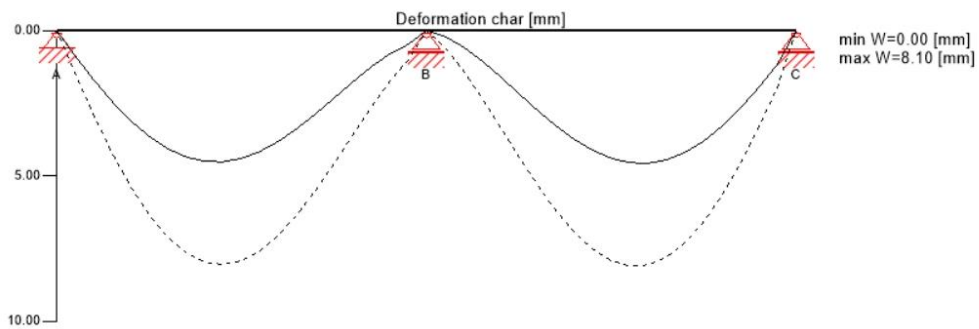



Diplomski ploča
Krovna ploča
Monika Spajić

11/13
10/09/2024

Service limit state design (SLS) - design results

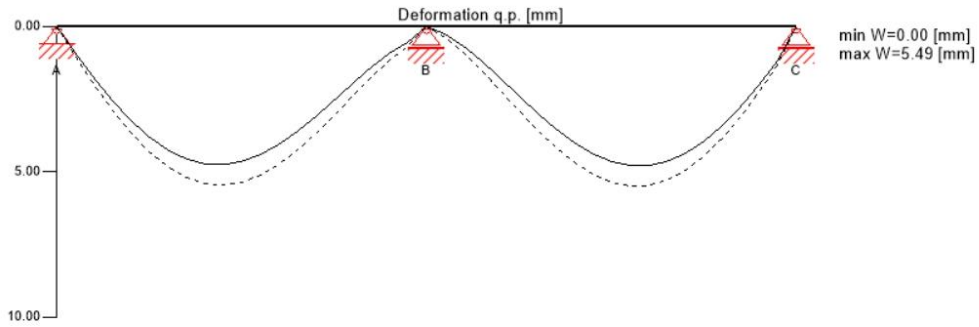

w_{inst} = w[char]

Field	K _{def}	Limit	w _{limit}	w _{calc.}	Ratio
		[-]	[mm]	[mm]	
1	0.8	L/300	24.0	8.1	34%
2	0.8	L/300	24.0	8.1	34%

w_{fin} = w[char] + w[q.p.]*kdef

Field	K _{def}	Limit	w _{limit}	w _{calc.}	Ratio
		[-]	[mm]	[mm]	
1	0.8	L/250	28.8	12.4	43%
2	0.8	L/250	28.8	12.5	43%

w_{net,fin} = w[q.p.] + w[q.p.]*kdef

Field	K _{def}	Limit	w _{limit}	w _{calc.}	Ratio
		[-]	[mm]	[mm]	
1	0.8	L/300	24.0	9.8	41%
2	0.8	L/300	24.0	9.9	41%

© 2024 - Calculatis by Stora Enso - Version 7.10.0
Any use of results of the software is only allowed, if the results have been verified and approved regarding completeness and correctness by a project structural/building physics engineer. For more information see the Terms of Use.



Diplomski_ploča
Krovna ploča
Monika Spajić

12/13
10/09/2024

Vibration analysis

General

Total mass	38.17 [t]
Tributary width	3.6 [m]
Stiffness Longitudinal direction	9712.0 [kNm ²]
Stiffness Cross direction	936.0 [kNm ²]
Modal damping	4.0 [%]
α	0.1 [-]
Man weight	700.0 [N]
Modal mass	6947.8 [kg]

Analysis

Criterion	Calc.	Class I	Class II	Class I	Class II	Cl. I	Cl. II
Frequency criterion min	5.802 [Hz]	4.5 [Hz]	4.5 [Hz]	78 %	78 %	✓	✓
Frequency criterion	5.802 [Hz]	8.0 [Hz]	6.0 [Hz]	138 %	103 %	✓	✓
Acceleration criterion	0.049 [m/s ²]	0.05 [m/s ²]	0.1 [m/s ²]	99 %	49 %	✓	✓
Stiffness criterion	0.22 [mm]	0.25 [mm]	0.5 [mm]	88 %	44 %	✓	✓

Support design

Nr.	Type	Width [mm]	Area [cm ²]	k_{mod} [-]	γ_m [-]	$k_{c,90}$ [-]	$f_{c,k}$ [N/mm ²]	$f_{c,d}$ [N/mm ²]	V_{max} [kN]	V_{min} [kN]	$\sigma_{c,90,d}$ [N/mm ²]	Ratio
A	Rigid plate	140	1700.00	0.90	1.25	1.50	2.50	2.70	15.63	0.00	0.09	LCO5 3%
B	Rigid plate	140	2000.00	0.90	1.25	1.80	2.50	3.24	50.50	0.00	0.25	LCO5 8%
C	Rigid plate	140	1700.00	0.90	1.25	1.50	2.50	2.70	15.63	0.00	0.09	LCO5 3%

Support reaction

Load case category	k_{mod}	A_v	B_v	C_v
		[kN]		
self-weight structure	0.6	3.00	9.85	3.00
		3.00	9.85	3.00
dead load	0.6	4.08	13.43	4.08
		4.08	13.43	4.08
live load cat. A: domestic, residential areas	0.8	1.90	5.37	1.90
		-0.26	0.00	-0.26
snow load altitude < 1.000 m a.s.l.	0.9	2.72	8.95	2.72
		0.00	0.00	0.00



Diplomski_ploča
Krovna ploča
Monika Spajčić

13/13
10/09/2024

Reference documents for this analysis

English title	Description
EN 338	EN 338 - Structural timber ? Strength classes
EN 1995-1-1	EN 1995-1-1 - Eurocode 5: Design of timber structures - Part 1-1: General - Common rules and rules for buildings
ETA-14/0349	European Technical Assessment ETA-14/0349
Expertise Rolling shear - no edge gluing, H.J. Blass	Expertise on Rolling shear for CLT
EN 1995-1-2	EN 1995-1-2 - Eurocode 5 — Design of timber structures — Part 1-2: General — Structural fire design
Technical expertise 122/2011/02: analysis of load bearing capacity and separation performance of CLT elements	Verification of the load bearing capacity and the insulation criterion of CLT structures with Stora Enso CLT
Technical expertise 2434/2012 - BB: failure time tf of gypsum fire boards (GKF) according to ON B 3410	Expertise on failure time tf of gypsum wall fire boards according to ON B3410 and gypsum wall boards type DF according to EN 520
EN 1990	EN 1990 - Eurocode ? Basis of structural design
ÖNorm B 1995-1-1 NA	ÖNORM EN 1995-1-1 - Austria - National Annex – Nationally determined parameters – Eurocode 5: Design of timber structures – Part 1-1: General-Common rules and rules for buildings
ÖNorm B 1995-1-2 NA	ÖNORM EN 1995-1-2 - Austria - National Annex - Eurocode 5: Design of timber structures ? Part 1-2: General ? Structural fire design ? National specifications concerning ÖNORM EN 1995-1-2, national comments and national supplements
Fire safety in timber buildings - technical guideline for Europe	Fire safety in timber buildings - technical guideline for Europe; publishes by SP Technical Research Institute of Sweden
National specifications concerning ÖNORM EN 1995-1-2, national comments and national supplements, chapter 12	ÖNORM EN 1995-1-2 - National specifications concerning ÖNORM EN 1995-1-2, national comments and national supplements, chapter 12
Expertise Rolling shear, H.J. Blass	Expertise on rolling shear strength and rolling shear modulus of CLT panels
ÖNORM EN 1995-1-1_NA, chapter 7.3	ÖNORM EN 1995-1-1 - Austria - National Annex – Nationally determined parameters – Eurocode 5: Design of timber structures – Part 1-1: General-Common rules and rules for buildings; chapter 7.3

Disclaimer

The software was created to assist engineers in their daily business. The software is an engineering software that is dealing with a very complex matter of structural analysis and building physics analysis. Therefore, this software shall only be operated by skilled, experienced engineers, with a deep understanding of structural engineering and building physics related to timber structures. The user of the software is obliged to check all input values, no matter if they were given by the user or given by default by the software and all results for plausibility. The use of the results of the software should not be relied upon as the basis for any decision or action. Any use of results of the software is only allowed, if the results have been verified and approved regarding completeness and correctness by a project structural/building physics engineer. The user has the possibility to make print-outs from the software. Any modification of those are not allowed. Stora Enso Wood Products GmbH does not assume any warranty regarding the software. The software has been developed with utmost diligence, nevertheless Stora Enso Wood Products GmbH, neither expressly nor implicitly, provides any warranty in terms of accuracy, validity, timeliness and completeness of information and data created by the software. Stora Enso Wood Products GmbH does also not assume any warranty for the general usability of the software, its suitability for a special purpose or for the compatibility of the software with the ones of third party producers or providers. Stora Enso Wood Products GmbH is only liable for damages caused by gross negligence or intent through Stora Enso Wood Products GmbH; the liability for slight negligence is excluded. This does not apply to personal injury. Under the aforementioned conditions Stora Enso Wood Products GmbH is as well not liable for operational failures or the loss of programs and/or data of the user's data processing system. Applicable Law. These terms of use shall be governed by the laws of Austria excluding however any conflict of laws rules and any laws regarding the Convention of the International Sale of Goods (CISG).

© 2024 - Calculatis by Stora Enso - Version 7.10.0

Any use of results of the software is only allowed, if the results have been verified and approved regarding completeness and correctness by a project structural/building physics engineer. For more information see the Terms of Use.

3.7. Dimenzioniranje čelične grede (HEA 300) – Stora Enso



Diplomski rad
Čelična greda
Monika Spajić

1/7
08/09/2024

System

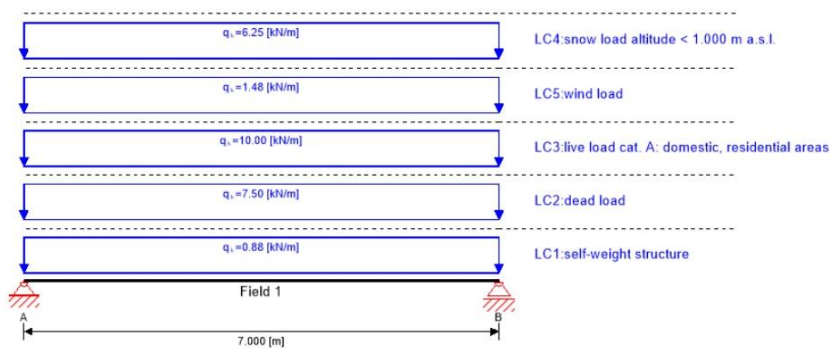

Global utilization ratio		79 %
ULS	50 %	SLS 79 %

Section

Name	Height	Width	t _f	t _w	Area	I _y	I _z	W _y	W _z	I _w	I _d	i _y	i _z	W _{y,pl}	W _{z,pl}
	[mm]	[mm]	[mm]	[mm]	[cm ²]	[cm ⁴]	[cm ⁴]	[cm ³]	[cm ³]	[cm ⁶]	[cm ⁴]	[cm]	[cm]	[cm ³]	[cm ³]
HE-A 300	290	300	14	8.5	112.5	18260	6310	1260	420.6	1200000	85.17	1.274	0.749	1383	641.2

Material values

Material	f _{m,k}	f _{t,0,k}	E _{0,mean}	G _{mean}
	[N/mm ²]	[N/mm ²]	[N/mm ²]	[N/mm ²]
Steel S355	355.00	510.00	210,000.0	80,700.00

Load

Load case groups

Load case category	Type	Duration	K _{mod}	γ _{inf}	γ _{sup}	ψ ₀	ψ ₁	ψ ₂
LC1 self-weight structure	G	permanent	1	1	1.35	1	1	1
LC2 dead load	G	permanent	1	1	1.35	1	1	1

© 2024 - Calculatis by Stora Enso - Version 7.10.0
Any use of results of the software is only allowed, if the results have been verified and approved regarding completeness and correctness by a project structural/building physics engineer. For more information see the Terms of Use.



Diplomski rad
Čelična greda
Monika Spajić

2/7
08/09/2024

Load case groups

Load case category	Type	Duration	K _{mod}	γ _{inf}	γ _{sup}	ψ ₀	ψ ₁	ψ ₂
LC3 live load cat. A: domestic, residential areas	Q	medium term	1	0	1.5	0.7	0.5	0.3
LC4 snow load altitude < 1.000 m a.s.l.	Q	short term	1	0	1.5	0.5	0.2	0
LC5 wind load	Q	short term	1	0	1.5	0.6	0.2	0

LC1: self-weight structure

continuous load

Field	Load at start
	[kN/m]
1	0.88

LC2: dead load

continuous load

Field	Load at start
	[kN/m]
1	7.50

LC3: live load cat. A: domestic, residential areas

continuous load

Field	Load at start
	[kN/m]
1	10.00

LC4: snow load altitude < 1.000 m a.s.l.



Diplomski rad
Čelična greda
Monika Spajić

3/7
08/09/2024

continuous load

Field	Load at start [kN/m]
1	6.25

LC5:wind load

continuous load

Field	Load at start [kN/m]
1	1.48

ULS Combinations

	Combination rule
LC01	$1.35/1.00 * LC1 + 1.35/1.00 * LC2$
LC02	$1.35/1.00 * LC1 + 1.35/1.00 * LC2 + 1.50/0.00 * LC3$
LC03	$1.35/1.00 * LC1 + 1.35/1.00 * LC2 + 1.50/0.00 * LC3 + 1.50/0.00 * 0.50 * LC4$
LC04	$1.35/1.00 * LC1 + 1.35/1.00 * LC2 + 1.50/0.00 * LC3 + 1.50/0.00 * 0.50 * LC4 + 1.50/0.00 * 0.60 * LC5$
LC05	$1.35/1.00 * LC1 + 1.35/1.00 * LC2 + 1.50/0.00 * LC4$
LC06	$1.35/1.00 * LC1 + 1.35/1.00 * LC2 + 1.50/0.00 * LC4 + 1.50/0.00 * 0.70 * LC3$
LC07	$1.35/1.00 * LC1 + 1.35/1.00 * LC2 + 1.50/0.00 * LC4 + 1.50/0.00 * 0.70 * LC3 + 1.50/0.00 * 0.60 * LC5$
LC08	$1.35/1.00 * LC1 + 1.35/1.00 * LC2 + 1.50/0.00 * LC5$
LC09	$1.35/1.00 * LC1 + 1.35/1.00 * LC2 + 1.50/0.00 * LC5 + 1.50/0.00 * 0.70 * LC3$
LC010	$1.35/1.00 * LC1 + 1.35/1.00 * LC2 + 1.50/0.00 * LC5 + 1.50/0.00 * 0.70 * LC3 + 1.50/0.00 * 0.50 * LC4$

ULS Combinations Fire

	Combination rule
LC011	$1.00/1.00 * LC1 + 1.00/1.00 * LC2$
LC012	$1.00/1.00 * LC1 + 1.00/1.00 * LC2 + 1.00/0.00 * 0.30 * LC3$
LC013	$1.00/1.00 * LC1 + 1.00/1.00 * LC2 + 1.00/0.00 * 0.30 * LC3 + 1.00/0.00 * 0.00 * LC4$
LC014	$1.00/1.00 * LC1 + 1.00/1.00 * LC2 + 1.00/0.00 * 0.30 * LC3 + 1.00/0.00 * 0.00 * LC4 + 1.00/0.00 * 0.00 * LC5$

© 2024 - Calculatis by Stora Enso - Version 7.10.0

Any use of results of the software is only allowed, if the results have been verified and approved regarding completeness and correctness by a project structural/building physics engineer. For more information see the Terms of Use.



Diplomski rad
Čelična greda
Monika Spajić

4/7
08/09/2024

ULS Combinations Fire

	Combination rule
LCO15	$1.00/1.00 * LC1 + 1.00/1.00 * LC2 + 1.00/0.00 * 0.00 * LC4$
LCO16	$1.00/1.00 * LC1 + 1.00/1.00 * LC2 + 1.00/0.00 * 0.00 * LC4 + 1.00/0.00 * 0.30 * LC3$
LCO17	$1.00/1.00 * LC1 + 1.00/1.00 * LC2 + 1.00/0.00 * 0.00 * LC4 + 1.00/0.00 * 0.30 * LC3 + 1.00/0.00 * 0.00 * LC5$
LCO18	$1.00/1.00 * LC1 + 1.00/1.00 * LC2 + 1.00/0.00 * 0.00 * LC5$
LCO19	$1.00/1.00 * LC1 + 1.00/1.00 * LC2 + 1.00/0.00 * 0.00 * LC5 + 1.00/0.00 * 0.30 * LC3$
LCO20	$1.00/1.00 * LC1 + 1.00/1.00 * LC2 + 1.00/0.00 * 0.00 * LC5 + 1.00/0.00 * 0.30 * LC3 + 1.00/0.00 * 0.00 * LC4$

SLS Characteristic Combination

	Combination rule
LCO21	$1.00/1.00 * LC1 + 1.00/1.00 * LC2$
LCO22	$1.00/1.00 * LC1 + 1.00/1.00 * LC2 + 1.00/0.00 * LC3 + 1.00/0.00 * 0.50 * LC4 + 1.00/0.00 * 0.60 * LC5$
LCO23	$1.00/1.00 * LC1 + 1.00/1.00 * LC2 + 1.00/0.00 * LC4 + 1.00/0.00 * 0.70 * LC3 + 1.00/0.00 * 0.60 * LC5$
LCO24	$1.00/1.00 * LC1 + 1.00/1.00 * LC2 + 1.00/0.00 * LC5 + 1.00/0.00 * 0.70 * LC3 + 1.00/0.00 * 0.50 * LC4$

SLS Quasi-permanent Combination

	Combination rule
LCO25	$1.00/1.00 * LC1 + 1.00/1.00 * LC2$
LCO26	$1.00/1.00 * LC1 + 1.00/1.00 * LC2 + 1.00/0.00 * 0.30 * LC3 + 1.00/0.00 * 0.00 * LC4 + 1.00/0.00 * 0.00 * LC5$
LCO27	$1.00/1.00 * LC1 + 1.00/1.00 * LC2 + 1.00/0.00 * 0.00 * LC4 + 1.00/0.00 * 0.30 * LC3 + 1.00/0.00 * 0.00 * LC5$
LCO28	$1.00/1.00 * LC1 + 1.00/1.00 * LC2 + 1.00/0.00 * 0.00 * LC5 + 1.00/0.00 * 0.30 * LC3 + 1.00/0.00 * 0.00 * LC4$

Flexural design

Q _{kl} =	3		Comb.	LCO7	
M _{Ed} =	199.21	kNm	M _{Rd} =	447.30	kNm
Ratio	45	%		100	%
		<			✓
Utilization ratio	45%				



Diplomski rad
 Čelična greda
 Monika Spajić

5/7
 08/09/2024

Shear analysis					
QkI =	3		Comb.	LCO7	
V _{Ed} =	113.83	kN	V _{Rd} =	763.47	kN
Ratio	15	%		100	% ✓
Utilization ratio					15%

Flexural design + Shear analysis					
QkI =	3		Comb.	LCO7	
V _{Ed} =	11.38	kN	V _{Rd} =	763.47	kN
M _{Ed} =	197.22	kNm	M _{Rd} =	447.30	kNm
Ratio	44	%		100	% ✓
Utilization ratio					44%

Lateral torsional buckling design					
QkI =	3		Comb.	LCO7	
N _{yEd} =	0.00	kN	N _{yRd} =	0.00	kN
N _{zEd} =	0.00	kN	N _{zRd} =	0.00	kN
M _{yEd} =	199.21	kNm	M _{yRd} =	401.37	kNm
Ratio	50	%		100	% ✓
Utilization ratio					50%

Service limit state design (SLS) - design results

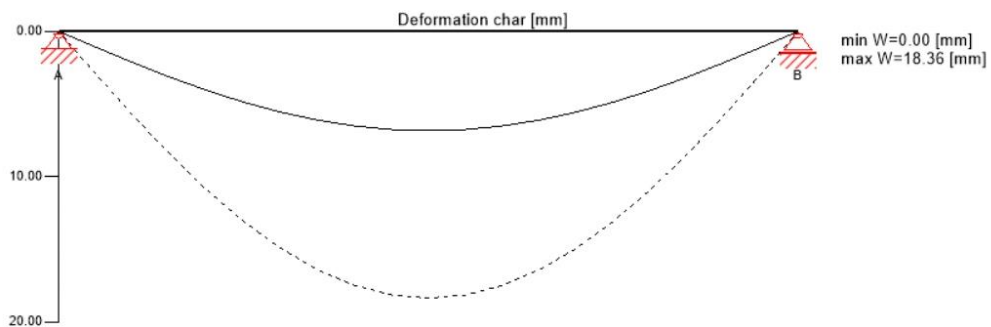

© 2024 - Calculatis by Stora Enso - Version 7.10.0
 Any use of results of the software is only allowed, if the results have been verified and approved regarding completeness and correctness by a project structural/building physics engineer. For more information see the Terms of Use.



Diplomski rad
 Čelična greda
 Monika Spajić

6/7
 08/09/2024

Service limit state design (SLS) - design results

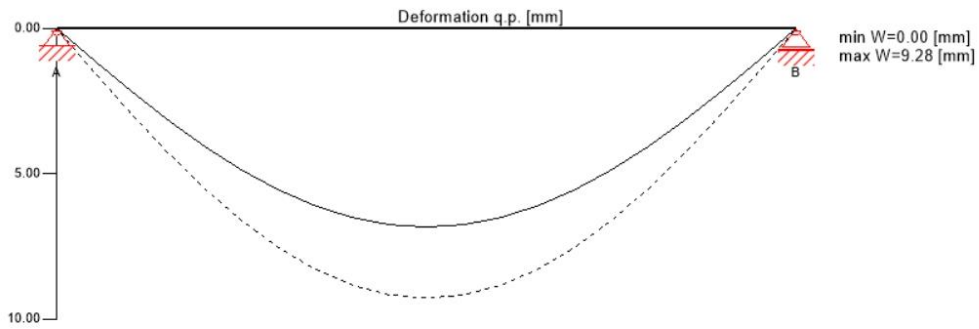

w _{inst} = w[char]				
Field	Limit	w _{limit}	w _{calc.}	Ratio
	[]	[mm]	[mm]	
1	L/300	23.3	18.4	79%

Support reaction			
Load case category	k _{mod}	A _v	B _v
		[kN]	
self-weight structure	1	3.09	3.09
		3.09	3.09
dead load	1	26.25	26.25
		26.25	26.25
live load cat. A: domestic, residential areas	1	35.00	35.00
		0.00	0.00
snow load altitude < 1.000 m a.s.l.	1	21.88	21.88
		0.00	0.00
wind load	1	5.18	5.18
		0.00	0.00

© 2024 - Calculatis by Stora Enso - Version 7.10.0
 Any use of results of the software is only allowed, if the results have been verified and approved regarding completeness and correctness by a project structural/building physics engineer. For more information see the Terms of Use.



Diplomski rad
Čelična greda
Monika Spajčić

7/7
08/09/2024

Reference documents for this analysis

English title	Description
EN 1993-1-1	EN 1993-1-1 - Eurocode 3: Design of steel structures - Part 1-1: General rules and rules for buildings
EN 1990	EN 1990 - Eurocode ? Basis of structural design

Disclaimer

The software was created to assist engineers in their daily business. The software is an engineering software that is dealing with a very complex matter of structural analysis and building physics analysis. Therefore, this software shall only be operated by skilled, experienced engineers, with a deep understanding of structural engineering and building physics related to timber structures. The user of the software is obliged to check all input values, no matter if they were given by the user or given by default by the software and all results for plausibility. The use of the results of the software should not be relied upon as the basis for any decision or action. Any use of results of the software is only allowed, if the results have been verified and approved regarding completeness and correctness by a project structural/building physics engineer. The user has the possibility to make print-outs from the software. Any modification of those are not allowed. Stora Enso Wood Products GmbH does not assume any warranty regarding the software. The software has been developed with utmost diligence, nevertheless Stora Enso Wood Products GmbH, neither expressly nor implicitly, provides any warranty in terms of accuracy, validity, timeliness and completeness of information and data created by the software. Stora Enso Wood Products GmbH does also not assume any warranty for the general usability of the software, its suitability for a special purpose or for the compatibility of the software with the ones of third party producers or providers. Stora Enso Wood Products GmbH is only liable for damages caused by gross negligence or intent through Stora Enso Wood Products GmbH; the liability for slight negligence is excluded. This does not apply to personal injury. Under the aforementioned conditions Stora Enso Wood Products GmbH is as well not liable for operational failures or the loss of programs and/or data of the user's data processing system. Applicable Law. These terms of use shall be governed by the laws of Austria excluding however any conflict of laws rules and any laws regarding the Convention of the International Sale of Goods (CISG).

3.8. Proračun karakterističnih spojeva – Stora Enso

3.8.1.1. Detalj A – spoj grede (GL32h) s međukatnom pločom (CLT)



Diplomski rad
Spoj grede s međukatnom konstrukcijom
Monika Spajić

1/4
10/09/2024

Connection

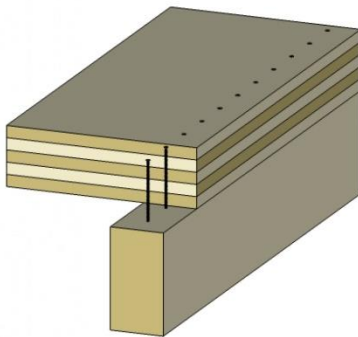

F_x	7.772	kN/m
F_y	12.674	kN/m
K_{mod}	0.8	-
Material 1	C24 spruce ETA (2022)	
ρ_k	3.85	kN/m ³
Panel 1	CLT 220 L7s - 2	
Orientation cover layer	X direction	
Material 2	C24 spruce	
ρ_k	3.5	kN/m ³
Connector type	Rothoblaas TBS	
Connectors	8/300	
Setup	Vertical	
Diameter	8	mm
Head diameter	19	mm
Length	300	mm
Thread length	100	mm
Pre-drilled	x	
Timber beam width	140	mm
Timber beam height	480	mm

Analysis				
Analysis	Existing	Limit	Unit	Utilization
Width 1	140	72	mm	51%
Width 2	140	72	mm	51%
Thickness 1	220	42	mm	19%
Thickness 2	80	45	mm	56%
F_v	2434.387	2434.387	N	100%
Count	6.107	25	Count / Im	24%



Diplomski rad
 Spoj grede s međukatnom konstrukcijom
 Monika Spajić

2/4
 10/09/2024

Structural system

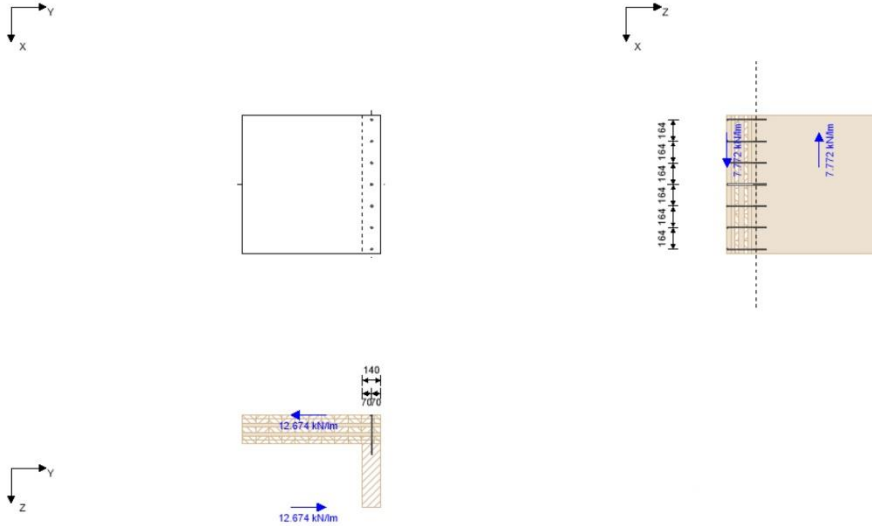

Minimum spacing						
Name	$a_{1,min}$	$a_{2,min}$	$a_{3c,min}$	$a_{3t,min}$	$a_{4c,min}$	$a_{4t,min}$
	[mm]	[mm]	[mm]	[mm]	[mm]	[mm]
CLT top	32	20	48	48	20	48
Timber beam bottom	40	32	32	80	24	24

Result in layers

Element 1						
X	Thick	Typ	α	l_{eff}	$l_{eff,v}$	$F_{ax,Rk}$
[mm]	[mm]		[°]	[mm]	[mm]	[N]
0	30	L	90	0	0	0
30	30	L	90	0	0	0
60	30	C	90	0	0	0
90	40	L	90	0	0	0
130	30	C	90	0	0	0
160	30	L	90	0	0	0
190	10	L	90	0	0	0
200	15	L	90	15	15	1515
215	5	L	90	0	0	0

© 2024 - Calculatis by Stora Enso - Version 7.10.0
 Any use of results of the software is only allowed, if the results have been verified and approved regarding completeness and correctness by a project structural/building physics engineer. For more information see the Terms of Use.



Diplomski rad
 Spoj grede s međukatnom konstrukcijom
 Monika Spajić

3/4
 10/09/2024

Results

b _{1,min}	b _{2,min}	f _{h,k,1}	f _{h,k,2}	β	t _{pen,1}	t _{pen,2}	l _{eff,1}	l _{eff,2}	t _{1,req}	t _{2,req}	F _{ax,Rk1}	F _{ax,Rk2}
[mm]	[mm]	[N/mm ²]	[N/mm ²]	[-]	[mm]	[mm]	[mm]	[mm]	[mm]	[mm]	[N]	[N]
72	72	21.21	19.68	1.08	220.00	80.00	15.00	65.00	42	45	1515.24	6084.00

Results

M _{y,Rk}	F _{ax,Rk}	F _{head,Rk}	F _{tens,Rk}	F _{kl,Rk}	F _{v,Rk}	F _{v,Rd}	F _{v,Ed}	F _{ax,Rd}	F _{ax,Ed}	Count	Count _{max}	a _{eff}
[Nmm]	[N]	[N]	[kN]	[kN]	[N]	[N]	[kN/m]	[N]	[kN/m]	[Stk/m]	[Stk/m]	[mm]
20057.48	4048.27	4048.27	20.100	0.000	3955.88	2434.39	14.87	2491.24	0.00	6.11	25.00	164

Reference documents for this analysis

English title	Description
EN 338	EN 338 - Structural timber ? Strength classes
EN 1995-1-1	EN 1995-1-1 - Eurocode 5: Design of timber structures - Part 1-1: General - Common rules and rules for buildings
EN 1990	EN 1990 - Eurocode ? Basis of structural design
ÖNorm B 1995-1-1 NA	ÖNORM EN 1995-1-1 - Austria - National Annex – Nationally determined parameters – Eurocode 5: Design of timber structures – Part 1-1: General-Common rules and rules for buildings
ÖNorm B 1995-1-2 NA	ÖNORM EN 1995-1-2 - Austria - National Annex - Eurocode 5: Design of timber structures ? Part 1-2: General ? Structural fire design ? National specifications concerning ÖNORM EN 1995-1-2, national comments and national supplements
ETA-11/0030	ETA-11/0030 European Technical Approval; Rothoblaas; Self-tapping screws for use in timber structures
ETA-12/0063	SFS intec AG; Self-tapping screws for use in timber constructions
ETA-12/0062	SFA intec AG; ETA-12/0062; selftapping screws for use in timber constructions
ETA-11/0086	GH Various Angle Brackets
ETA-09/0322	GH Various Angle Brackets
ETA-11/0496	Rotho Blaas TITAN Angle Brackets
ETA-11/0190	selftaping screw by Würth
ETA-12/0373	Schmid - Screws for use in timber constructions
ETA-12/0114	SPAX - Screws for use in timber constructions

© 2024 - Calculatis by Stora Enso - Version 7.10.0
 Any use of results of the software is only allowed, if the results have been verified and approved regarding completeness and correctness by a project structural/building physics engineer. For more information see the Terms of Use.



Diplomski rad
Spoj grede s međukatnom konstrukcijom
Monika Spajić

4/4
10/09/2024

Reference documents for this analysis

English title	Description
ETA-21/0670	Simpson Strong-Tie® Structural screws SWW, SWC, TTUFS, TTSFS and TTZNFS
ETA-13/0796	Simpson Strong-Tie® screws ESCR/ESCR-S, ESCRC/ESCRC-S, ESCRS, ESCRFTC, ESCRFT/FTZ, ESCRHD/HRD, ESCRT2R, SSTA and ESCRH
ETA-20/0773	Würth - DENEb Angle Brackets and plate connectors
ETA-08/0183	Würth - Typ A + Typ V Angle Bracket
ETA-14/0274	Würth - Hold down and storey connector

Disclaimer

The software was created to assist engineers in their daily business. The software is an engineering software that is dealing with a very complex matter of structural analysis and building physics analysis. Therefore, this software shall only be operated by skilled, experienced engineers, with a deep understanding of structural engineering and building physics related to timber structures. The user of the software is obliged to check all input values, no matter if they were given by the user or given by default by the software and all results for plausibility. The use of the results of the software should not be relied upon as the basis for any decision or action. Any use of results of the software is only allowed, if the results have been verified and approved regarding completeness and correctness by a project structural/building physics engineer. The user has the possibility to make print-outs from the software. Any modification of those are not allowed. Stora Enso Wood Products GmbH does not assume any warranty regarding the software. The software has been developed with utmost diligence, nevertheless Stora Enso Wood Products GmbH, neither expressly nor implicitly, provides any warranty in terms of accuracy, validity, timeliness and completeness of information and data created by the software. Stora Enso Wood Products GmbH does also not assume any warranty for the general usability of the software, its suitability for a special purpose or for the compatibility of the software with the ones of third party producers or providers. Stora Enso Wood Products GmbH is only liable for damages caused by gross negligence or intent through Stora Enso Wood Products GmbH; the liability for slight negligence is excluded. This does not apply to personal injury. Under the aforementioned conditions Stora Enso Wood Products GmbH is as well not liable for operational failures or the loss of programs and/or data of the user's data processing system.
Applicable Law: These terms of use shall be governed by the laws of Austria excluding however any conflict of laws rules and any laws regarding the Convention of the International Sale of Goods (CISG).

Mjerodavni odabrani razmak je 150 mm.

3.8.1.2. Detalj B – spoj međukatne konstrukcije (CLT) sa zidnim panelima (CLT)



Diplomski rad
Spoj CLT panela na CLT zidne panele
Monika Spajić

1/4
10/09/2024

Connection

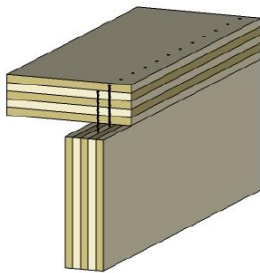

F_x	5.848	kN/m
F_y	6.656	kN/m
K_{mod}	0.8	-
Material 1	C24 spruce ETA (2022)	
ρ_k	3.85	kN/m ³
Panel 1	CLT 220 L7s - 2	
Orientation cover layer	X direction	
Material 2	C24 spruce ETA (2022)	
ρ_k	3.85	kN/m ³
Panel 2	CLT 140 L5s	
Orientation cover layer	✓	
Connector type	Rothoblaas HBS	
Connectors	10/360	
Setup	Vertical	
Diameter	10	mm
Head diameter	18.25	mm
Length	360	mm
Thread length	100	mm
Connector positions	x	
Pre-drilled	x	

Analysis

Analysis	Existing	Limit	Unit	Utilization
Width 1	140	120	mm	86%
Width 2	140	120	mm	86%
Thickness 1	220	47	mm	22%
Thickness 2	140	102	mm	73%
F_v	2419.803	2419.803	N	100%
Count	3.661	10	Count / lm	37%
Splitting stress analysis unreinforced	0.136	1.947	N/mm ²	7%



Diplomski rad
 Spoj CLT panela na CLT zidne panele
 Monika Spajić

2/4
 10/09/2024

Structural system

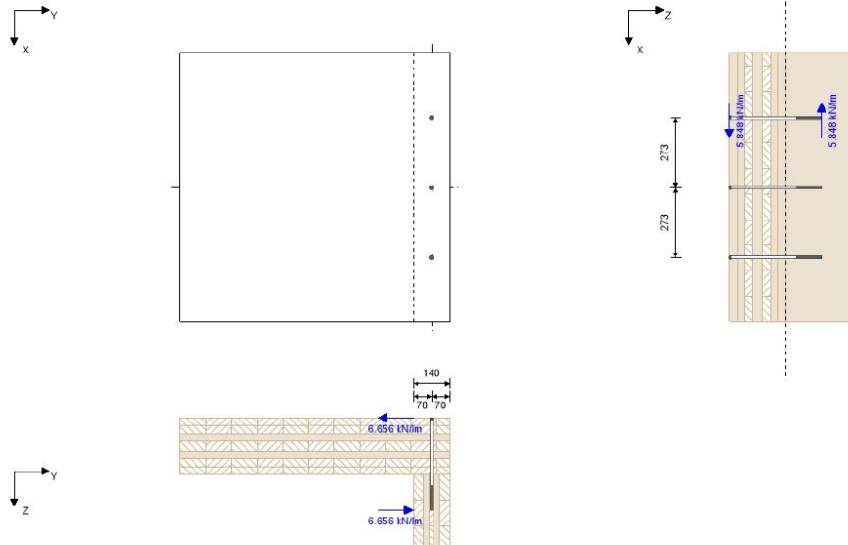

Minimum spacing

Name	$a_{1,min}$ [mm]	$a_{2,min}$ [mm]	$a_{3c,min}$ [mm]	$a_{3y,min}$ [mm]	$a_{4c,min}$ [mm]	$a_{4t,min}$ [mm]
CLT top	40	25	60	60	25	60
CLT bottom	100	40	70	120	30	60

Result in layers

Element 1

X [mm]	Thick [mm]	Typ	α [°]	l_{eff} [mm]	$l_{eff,v}$ [mm]	$F_{ax,Rk}$ [N]
0	30	L	90	0	0	0
30	30	L	90	0	0	0
60	30	C	90	0	0	0
90	40	L	90	0	0	0
130	30	C	90	0	0	0
160	30	L	90	0	0	0
190	30	L	90	0	0	0

© 2024 - Calculatis by Stora Enso - Version 7.10.0
 Any use of results of the software is only allowed, if the results have been verified and approved regarding completeness and correctness by a project structural/building physics engineer. For more information see the Terms of Use.



Diplomski rad
Spoj CLT panela na CLT zidne panele
Monika Spajić

3/4
10/09/2024

Results												
b _{1,min}	b _{2,min}	f _{h,k,1}	f _{h,k,2}	β	t _{pen,1}	t _{pen,2}	l _{eff,1}	l _{eff,2}	t _{1,req}	t _{2,req}	F _{ax,Rk1}	F _{ax,Rk2}
[mm]	[mm]	[N/mm ²]	[N/mm ²]	[-]	[mm]	[mm]	[mm]	[mm]	[mm]	[mm]	[N]	[N]
120	120	18.97	6.32	3.00	220.00	140.00	0.00	100.00	47	102	0.00	12627.00

Results												
M _{y,Rk}	F _{ax,Rk}	F _{head,Rk}	F _{tens,Rk}	F _{ti,Rk}	F _{v,Rk}	F _{v,Rd}	F _{v,Ed}	F _{ax,Rd}	F _{ax,Ed}	Count	Count _{max}	a _{eff}
[Nmm]	[N]	[N]	[kN]	[kN]	[N]	[N]	[kN/m]	[N]	[kN/m]	[Stk/m]	[Stk/m]	[mm]
35829.64	3734.97	3734.97	31.400	0.000	3932.18	2419.80	8.86	2298.45	0.00	3.66	10.00	273

Reference documents for this analysis	
English title	Description
EN 338	EN 338 - Structural timber ? Strength classes
EN 1995-1-1	EN 1995-1-1 - Eurocode 5: Design of timber structures - Part 1-1: General - Common rules and rules for buildings
EN 1990	EN 1990 - Eurocode ? Basis of structural design
ÖNorm B 1995-1-1 NA	ÖNORM EN 1995-1-1 - Austria - National Annex – Nationally determined parameters – Eurocode 5: Design of timber structures – Part 1-1: General-Common rules and rules for buildings
ÖNorm B 1995-1-2 NA	ÖNORM EN 1995-1-2 - Austria - National Annex - Eurocode 5: Design of timber structures ? Part 1-2: General ? Structural fire design ? National specifications concerning ÖNORM EN 1995-1-2, national comments and national supplements
ETA-11/0030	ETA-11/0030 European Technical Approval; Rothoblaas; Self-tapping screws for use in timber structures
ETA-12/0063	SFS intec AG; Self-tapping screws for use in timber constructions
ETA-12/0062	SFA intec AG; ETA-12/0062; selftapping screws for use in timber constructions
ETA-11/0086	GH Various Angle Brackets
ETA-09/0322	GH Various Angle Brackets
ETA-11/0496	Rotho Blaas TITAN Angle Brackets
ETA-11/0190	selftaping screw by Würth
ETA-12/0373	Schmid - Screws for use in timber constructions
ETA-12/0114	SPAX - Screws for use in timber constructions



Diplomski rad
Spoj CLT panela na CLT zidne panele
Monika Spajić

4/4
10/09/2024

Reference documents for this analysis

English title	Description
ETA-21/0670	Simpson Strong-Tie® Structural screws SWW, SWC, TTUFS, TTSFS and TTZNFS
ETA-13/0796	Simpson Strong-Tie® screws ESCR/ESCR-S, ESCRC/ESCRC-S, ESCRS, ESCRFTC, ESCRFT/FTZ, ESCRHD/HRD, ESCRT2R, SSTA and ESCRH
ETA-20/0773	Würth - DENEK Angle Brackets and plate connectors
ETA-08/0183	Würth - Typ A + Typ V Angle Bracket
ETA-14/0274	Würth - Hold down and storey connector

Disclaimer

The software was created to assist engineers in their daily business. The software is an engineering software that is dealing with a very complex matter of structural analysis and building physics analysis. Therefore, this software shall only be operated by skilled, experienced engineers, with a deep understanding of structural engineering and building physics related to timber structures. The user of the software is obliged to check all input values, no matter if they were given by the user or given by default by the software and all results for plausibility. The use of the results of the software should not be relied upon as the basis for any decision or action. Any use of results of the software is only allowed, if the results have been verified and approved regarding completeness and correctness by a project structural/building physics engineer. The user has the possibility to make print-outs from the software. Any modification of those are not allowed. Stora Enso Wood Products GmbH does not assume any warranty regarding the software. The software has been developed with utmost diligence, nevertheless Stora Enso Wood Products GmbH, neither expressly nor implicitly, provides any warranty in terms of accuracy, validity, timeliness and completeness of information and data created by the software. Stora Enso Wood Products GmbH does also not assume any warranty for the general usability of the software, its suitability for a special purpose or for the compatibility of the software with the ones of third party producers or providers. Stora Enso Wood Products GmbH is only liable for damages caused by gross negligence or intent through Stora Enso Wood Products GmbH; the liability for slight negligence is excluded. This does not apply to personal injury. Under the aforementioned conditions Stora Enso Wood Products GmbH is as well not liable for operational failures or the loss of programs and/or data of the user's data processing system. Applicable Law: These terms of use shall be governed by the laws of Austria excluding however any conflict of laws rules and any laws regarding the Convention of the International Sale of Goods (CISG).

Mjerodavni odabrani razmak je 200 mm.

3.8.1.3. Detalj C – spoj zidnih panela (CLT) vertikalno



Diplomski rad
Spoj zidnih CLT panela vertikalno
Monika Spajić

1/2
10/09/2024

Connection

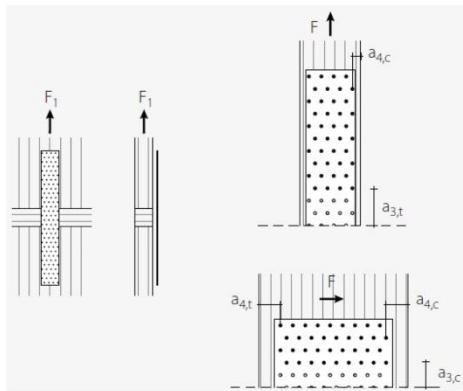

F_1	43.31	kN
K_{mod}	0.8	-
Connectors	LBV160400 / Nail 4,0x60	
Space		mm

Design F_1

$F_{k,1} =$	43.3	kN		$R_{k,1,Holz} =$		kN
				$\gamma_m =$	1.3	-
				$k_{mod} =$	0.80	-
$F_{d,1} =$	43.3	kN	<	$R_{d,1} =$	57.0	kN ✓

Utilization ratio 76%

Reference documents for this analysis

English title	Description
EN 338	EN 338 - Structural timber ? Strength classes
EN 1995-1-1	EN 1995-1-1 - Eurocode 5: Design of timber structures - Part 1-1: General - Common rules and rules for buildings
EN 1990	EN 1990 - Eurocode ? Basis of structural design
ÖNorm B 1995-1-1 NA	ÖNORM EN 1995-1-1 - Austria - National Annex – Nationally determined parameters – Eurocode 5: Design of timber structures – Part 1-1: General-Common rules and rules for buildings
ÖNorm B 1995-1-2 NA	ÖNORM EN 1995-1-2 - Austria - National Annex - Eurocode 5: Design of timber structures ? Part 1-2: General ? Structural fire design ? National specifications concerning ÖNORM EN 1995-1-2, national comments and national supplements
ETA-11/0030	ETA-11/0030 European Technical Approval; Rothoblaas; Self-tapping screws for use in timber structures
ETA-12/0063	SFS intec AG; Self-tapping screws for use in timber constructions

© 2024 - Calculatis by Stora Enso - Version 7.10.0

Any use of results of the software is only allowed, if the results have been verified and approved regarding completeness and correctness by a project structural/building physics engineer. For more information see the Terms of Use.



Diplomski rad
Spoj zidnih CLT panela vertikalno
Monika Spajić

2/2
10/09/2024

Reference documents for this analysis

English title	Description
ETA-12/0062	SFA intec AG; ETA-12/0062; selftapping screws for use in timber constructions
ETA-11/0086	GH Various Angle Brackets
ETA-09/0322	GH Various Angle Brackets
ETA-11/0496	Rotho Blaas TITAN Angle Brackets
ETA-11/0190	selftaping screw by Würth
ETA-12/0373	Schmid - Screws for use in timber constructions
ETA-12/0114	SPAX - Screws for use in timber constructions
ETA-21/0670	Simpson Strong-Tie® Structural screws SWW, SWC, TTUFS, TTSFS and TTZNFS
ETA-13/0796	Simpson Strong-Tie® screws ESCR/ESCR-S, ESCRC/ESCRC-S., ESCRS, ESCRFTC, ESCRFT/FTZ, ESCRHD/HRD, ESCRT2R, SSTA and ESCRH
ETA-20/0773	Würth - DENEK Angle Brackets and plate connectors
ETA-08/0183	Würth - Typ A + Typ V Angle Bracket
ETA-14/0274	Würth - Hold down and storey connector

Disclaimer

The software was created to assist engineers in their daily business. The software is an engineering software that is dealing with a very complex matter of structural analysis and building physics analysis. Therefore, this software shall only be operated by skilled, experienced engineers, with a deep understanding of structural engineering and building physics related to timber structures. The user of the software is obliged to check all input values, no matter if they were given by the user or given by default by the software and all results for plausibility. The use of the results of the software should not be relied upon as the basis for any decision or action. Any use of results of the software is only allowed, if the results have been verified and approved regarding completeness and correctness by a project structural/building physics engineer. The user has the possibility to make print-outs from the software. Any modification of those are not allowed. Stora Enso Wood Products GmbH does not assume any warranty regarding the software. The software has been developed with utmost diligence, nevertheless Stora Enso Wood Products GmbH, neither expressly nor implicitly, provides any warranty in terms of accuracy, validity, timeliness and completeness of information and data created by the software. Stora Enso Wood Products GmbH does also not assume any warranty for the general usability of the software, its suitability for a special purpose or for the compatibility of the software with the ones of third party producers or providers. Stora Enso Wood Products GmbH is only liable for damages caused by gross negligence or intent through Stora Enso Wood Products GmbH, the liability for slight negligence is excluded. This does not apply to personal injury. Under the aforementioned conditions Stora Enso Wood Products GmbH is as well not liable for operational failures or the loss of programs and/or data of the user's data processing system. Applicable Law: These terms of use shall be governed by the laws of Austria excluding however any conflict of laws rules and any laws regarding the Convention of the International Sale of Goods (CISG).

© 2024 - Calculatis by Stora Enso - Version 7.10.0

Any use of results of the software is only allowed, if the results have been verified and approved regarding completeness and correctness by a project structural/building physics engineer. For more information see the Terms of Use.

3.8.1.4. Detalj D – spoj panela međukatne konstrukcije (CLT) međusobno u ravnini



Diplomski rad
Spoj CLT panela međusobno u ravnini
Monika Spajić

1/4
10/09/2024

Connection

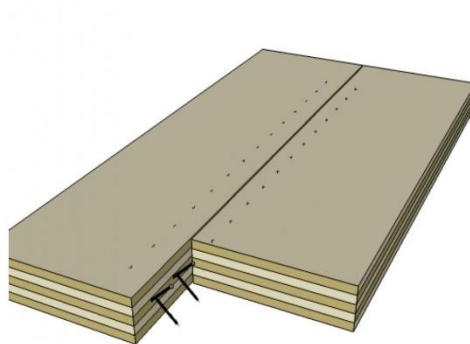

F_x	8.442	kN/m
F_y	4.265	kN/m
F_z	11.545	kN/m
K_{mod}	0.8	-
Material 1	C24 spruce ETA (2022)	
p_k	3.85	kN/m ³
Panel 1	CLT 220 L7s - 2	
Orientation cover layer	X direction	
Connector type	Rothoblaas VGS	
Connectors	11/200	
Setup	45° / 135° alternating	
Diameter	11	mm
Head diameter	19.3	mm
Length	200	mm
Thread length	190	mm
Pre-drilled	x	

Analysis

Analysis	Existing	Limit	Unit	Utilization
Thickness 1	100	60	mm	60%
Thickness 2	100	60	mm	60%
F_v	2324.887	4786.041	N	49%
F_{ax}	6157.485	7044.453	N	87%
Combination	1	1	-	100%
Count	3.631	4.228	Count / lm	86%



Diplomski rad
 Spoj CLT panela međusobno u ravnini
 Monika Spajić

2/4
 10/09/2024

Structural system

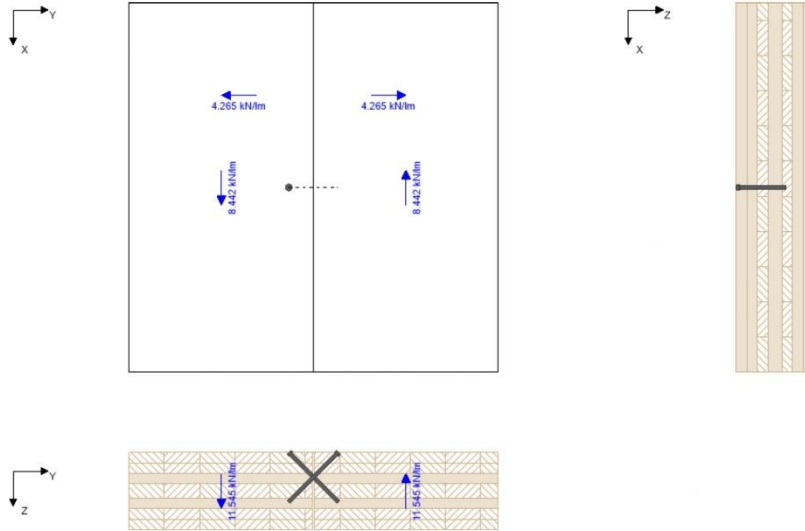

Minimum spacing

Name	a _{1,min} [mm]	a _{2,min} [mm]	a _{3c,min} [mm]	a _{3t,min} [mm]	a _{4c,min} [mm]	a _{4t,min} [mm]
CLT left	55	28	66	66	44	66
CLT right	55	28	66	66	44	66

Result in layers

Element 1							Element 2						
X	Thick	Typ	α	l _{eff}	l _{eff,v}	F _{ax,Rk}	X	Thick	Typ	α	l _{eff}	l _{eff,v}	F _{ax,Rk}
[mm]	[mm]		[°]	[mm]	[mm]	[N]	[mm]	[mm]		[°]	[mm]	[mm]	[N]
0	7	L	90	0	0	0	0	30	L	90	0	0	0
7	23	L	90	32.4	22.9	4504	30	30	L	90	0	0	0
30	30	L	90	42.4	30	5893	60	14	C	45	0	0	0
60	7	C	45	10.1	7.2	1281	74	16	C	45	22.3	15.8	2813
67	23	C	45	0	0	0	90	40	L	90	56.6	40	7857
90	40	L	90	0	0	0	130	4	C	45	6.2	4.4	777
130	30	C	45	0	0	0	134	26	C	45	0	0	0
160	30	L	90	0	0	0	160	30	L	90	0	0	0
190	30	L	90	0	0	0	190	30	L	90	0	0	0

© 2024 - Calculatis by Stora Enso - Version 7.10.0
 Any use of results of the software is only allowed, if the results have been verified and approved regarding completeness and correctness by a project structural/building physics engineer. For more information see the Terms of Use.



Diplomski rad
Spoj CLT panela međusobno u ravnini
Monika Spajić

3/4
10/09/2024

Results

$b_{1,min}$	$b_{2,min}$	$f_{h,k,1}$	$f_{h,k,2}$	β	$t_{pen,1}$	$t_{pen,2}$	$l_{eff,1}$	$l_{eff,2}$	$t_{1,req}$	$t_{2,req}$	$F_{ax,Rk1}$	$F_{ax,Rk2}$
[mm]	[mm]	[N/mm ²]	[N/mm ²]	[-]	[mm]	[mm]	[mm]	[mm]	[mm]	[mm]	[N]	[N]
0	0	18.09	18.09	1.00	100.00	100.00	85.00	85.00	60	60	11678.1	11447.23

Results

$M_{y,Rk}$	$F_{ax,Rk}$	$F_{head,Rk}$	$F_{tens,Rk}$	$F_{hi,Rk}$	$F_{v,Rk}$	$F_{v,Rd}$	$F_{v,Ed}$	$F_{ax,Rd}$	$F_{ax,Ed}$	Count	Count _{max}	a_{eff}
[Nmm]	[N]	[N]	[kN]	[kN]	[N]	[N]	[kN/m]	[N]	[kN/m]	[Stk/m]	[Stk/m]	[mm]
45905.37	11447.23	0.00	38.000	20.612	7777.32	4786.04	8.44	7044.45	22.36	3.63	4.23	275

Reference documents for this analysis

English title	Description
EN 338	EN 338 - Structural timber ? Strength classes
EN 1995-1-1	EN 1995-1-1 - Eurocode 5: Design of timber structures - Part 1-1: General - Common rules and rules for buildings
EN 1990	EN 1990 - Eurocode ? Basis of structural design
ÖNorm B 1995-1-1 NA	ÖNORM EN 1995-1-1 - Austria - National Annex – Nationally determined parameters – Eurocode 5: Design of timber structures – Part 1-1: General-Common rules and rules for buildings
ÖNorm B 1995-1-2 NA	ÖNORM EN 1995-1-2 - Austria - National Annex - Eurocode 5: Design of timber structures ? Part 1-2: General ? Structural fire design ? National specifications concerning ÖNORM EN 1995-1-2, national comments and national supplements
ETA-11/0030	ETA-11/0030 European Technical Approval; Rothoblaas; Self-tapping screws for use in timber structures
ETA-12/0063	SFS intec AG; Self-tapping screws for use in timber constructions
ETA-12/0062	SFA intec AG; ETA-12/0062; selftapping screws for use in timber constructions
ETA-11/0086	GH Various Angle Brackets
ETA-09/0322	GH Various Angle Brackets
ETA-11/0496	Rotho Blaas TITAN Angle Brackets
ETA-11/0190	selftaping screw by Würth
ETA-12/0373	Schmid - Screws for use in timber constructions
ETA-12/0114	SPAX - Screws for use in timber constructions



Diplomski rad
Spoj CLT panela međusobno u ravnini
Monika Spajić

4/4
10/09/2024

Reference documents for this analysis

English title	Description
ETA-21/0670	Simpson Strong-Tie® Structural screws SWW, SWC, TTUFS, TTSFS and TTZNFS
ETA-13/0796	Simpson Strong-Tie® screws ESCR/ESCR-S, ESCRC/ESCRC-S, ESCRS, ESCRFTC, ESCRFT/FTZ, ESCRHD/HRD, ESCRT2R, SSTA and ESCRH
ETA-20/0773	Würth - DENEb Angle Brackets and plate connectors
ETA-08/0183	Würth - Typ A + Typ V Angle Bracket
ETA-14/0274	Würth - Hold down and storey connector

Disclaimer

The software was created to assist engineers in their daily business. The software is an engineering software that is dealing with a very complex matter of structural analysis and building physics analysis. Therefore, this software shall only be operated by skilled, experienced engineers, with a deep understanding of structural engineering and building physics related to timber structures. The user of the software is obliged to check all input values, no matter if they were given by the user or given by default by the software and all results for plausibility. The use of the results of the software should not be relied upon as the basis for any decision or action. Any use of results of the software is only allowed, if the results have been verified and approved regarding completeness and correctness by a project structural/building physics engineer. The user has the possibility to make print-outs from the software. Any modification of those are not allowed. Stora Enso Wood Products GmbH does not assume any warranty regarding the software. The software has been developed with utmost diligence, nevertheless Stora Enso Wood Products GmbH, neither expressly nor implicitly, provides any warranty in terms of accuracy, validity, timeliness and completeness of information and data created by the software. Stora Enso Wood Products GmbH does also not assume any warranty for the general usability of the software, its suitability for a special purpose or for the compatibility of the software with the ones of third party producers or providers. Stora Enso Wood Products GmbH is only liable for damages caused by gross negligence or intent through Stora Enso Wood Products GmbH; the liability for slight negligence is excluded. This does not apply to personal injury. Under the aforementioned conditions Stora Enso Wood Products GmbH is as well not liable for operational failures or the loss of programs and/or data of the user's data processing system.
Applicable Law: These terms of use shall be governed by the laws of Austria excluding however any conflict of laws rules and any laws regarding the Convention of the International Sale of Goods (CISG).

Mjerodavni maksimalni razmak spojnih sredstava je 200 mm.

3.8.1.5. Detalj E – spoj zidnih panela (CLT) s AB zidom



Diplomski rad
Spoj CLT panela s betonskim zidom
Monika Spajčić

1/3
10/09/2024

Connection

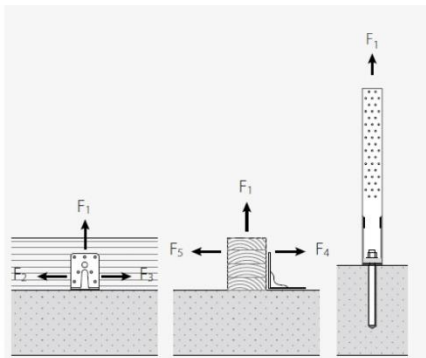

F_1	6.211	kN
F_{23}	6.991	kN
F_{45}	4.206	kN
k_{mod}	0.8	-
Connectors	AG922 / Nail CNA 4,0x50	
ϕ_{45}		mm

Design F_1					
$F_{k,1}$	=	6.2	kN		
				$R_{k,1,Holz}$	= 15.3 kN
				$R_{k,1,Stahl}$	= kN
				γ_m	= 1.3 -
				k_{mod}	= 0.80 -
$F_{d,1}$	=	6.2	kN	<	$R_{d,1}$ = 9.4 kN ✓
Utilization ratio					66%

Design F_{23}					
$F_{k,23}$	=	7.0	kN		
				$R_{k,23,Holz}$	= 24.1 kN
				γ_m	= 1.3 -
				k_{mod}	= 0.80 -
$F_{d,23}$	=	7.0	kN	<	$R_{d,23}$ = 14.8 kN ✓
Utilization ratio					47%



Diplomski rad
Spoj CLT panela s betonskim zidom
Monika Spajić

2/3
10/09/2024

Design F_{45}					
$F_{k,45} =$	4.2	kN	$R_{k,45,Holz} =$	24.8	kN
			$\gamma_m =$	1.3	-
			$k_{mod} =$	0.80	-
$F_{d,45} =$	4.2	kN	$R_{d,45} =$	15.3	kN ✓
Utilization ratio					28%

Design forces for anchorage to concrete

Design values, having "in" in the index refer to an inner anchor position
Design values, having "out" in the index refer to an outer anchor position
See technical approvals and assessment documents

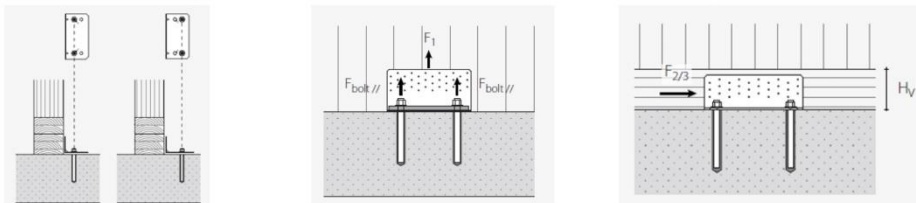

Reference documents for this analysis

English title	Description
EN 338	EN 338 - Structural timber ? Strength classes
EN 1995-1-1	EN 1995-1-1 - Eurocode 5: Design of timber structures - Part 1-1: General - Common rules and rules for buildings
EN 1990	EN 1990 - Eurocode ? Basis of structural design
ÖNorm B 1995-1-1 NA	ÖNORM EN 1995-1-1 - Austria - National Annex – Nationally determined parameters – Eurocode 5: Design of timber structures – Part 1-1: General-Common rules and rules for buildings
ÖNorm B 1995-1-2 NA	ÖNORM EN 1995-1-2 - Austria - National Annex - Eurocode 5: Design of timber structures ? Part 1-2: General ? Structural fire design ? National specifications concerning ÖNORM EN 1995-1-2, national comments and national supplements
ETA-11/0030	ETA-11/0030 European Technical Approval; Rothoblaas; Self-tapping screws for use in timber structures
ETA-12/0063	SFS intec AG; Self-tapping screws for use in timber constructions
ETA-12/0062	SFA intec AG; ETA-12/0062; selftapping screws for use in timber constructions

© 2024 - Calculatis by Stora Enso - Version 7.10.0
Any use of results of the software is only allowed, if the results have been verified and approved regarding completeness and correctness by a project structural/building physics engineer. For more information see the Terms of Use.



Diplomski rad
Spoj CLT panela s betonskim zidom
Monika Spajić

3/3
10/09/2024

Reference documents for this analysis

English title	Description
ETA-11/0086	GH Various Angle Brackets
ETA-09/0322	GH Various Angle Brackets
ETA-11/0496	Rotho Blaas TITAN Angle Brackets
ETA-11/0190	selftaping screw by Würth
ETA-12/0373	Schmid - Screws for use in timber constructions
ETA-12/0114	SPAX - Screws for use in timber constructions
ETA-21/0670	Simpson Strong-Tie® Structural screws SWW, SWC, TTUFS, TTSFS and TTZNFS
ETA-13/0796	Simpson Strong-Tie® screws ESCR/ESCR-S, ESCRC/ESCRC-S., ESCRS, ESCRFTC, ESCRFT/FTZ, ESCRHD/HRD, ESCRT2R, SSTA and ESCRH
ETA-20/0773	Würth - DENEb Angle Brackets and plate connectors
ETA-08/0183	Würth - Typ A + Typ V Angle Bracket
ETA-14/0274	Würth - Hold down and storey connector

Disclaimer

The software was created to assist engineers in their daily business. The software is an engineering software that is dealing with a very complex matter of structural analysis and building physics analysis. Therefore, this software shall only be operated by skilled, experienced engineers, with a deep understanding of structural engineering and building physics related to timber structures. The user of the software is obliged to check all input values, no matter if they were given by the user or given by default by the software and all results for plausibility. The use of the results of the software should not be relied upon as the basis for any decision or action. Any use of results of the software is only allowed, if the results have been verified and approved regarding completeness and correctness by a project structural/building physics engineer. The user has the possibility to make print-outs from the software. Any modification of those are not allowed. Stora Enso Wood Products GmbH does not assume any warranty regarding the software. The software has been developed with utmost diligence, nevertheless Stora Enso Wood Products GmbH, neither expressly nor implicitly, provides any warranty in terms of accuracy, validity, timeliness and completeness of information and data created by the software. Stora Enso Wood Products GmbH does also not assume any warranty for the general usability of the software, its suitability for a special purpose or for the compatibility of the software with the ones of third party producers or providers. Stora Enso Wood Products GmbH is only liable for damages caused by gross negligence or intent through Stora Enso Wood Products GmbH; the liability for slight negligence is excluded. This does not apply to personal injury. Under the aforementioned conditions Stora Enso Wood Products GmbH is as well not liable for operational failures or the loss of programs and/or data of the user's data processing system.

Applicable Law: These terms of use shall be governed by the laws of Austria excluding however any conflict of laws rules and any laws regarding the Convention of the International Sale of Goods (CISG).

3.8.1.6. Detalj F – spoj međukatne konstrukcije (CLT) na čeličnu gredu



Diplomski rad
Spoj CLT panela na čeličnu gredu
Monika Spajčić

1/4
10/09/2024

Connection

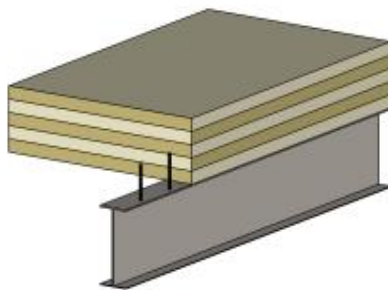

F_x	39.61	kN/m
F_z	7.59	kN/m
K_{rest}	0.8	-
Material 1	Steel S355	
ρ_s		kN/m ³
Material 2	C24 spruce ETA (2022)	
ρ_s	3.85	kN/m ³
Panel 2	CLT 220 L7s - 2	
Orientation cover layer	✓	
Connector type	Rothoblaas HBS	
Connectors	10/140	
Diameter	10	mm
Head diameter	18.25	mm
Length	140	mm
Thread length	60	mm
Number of rows	2	
Steel element width	300	mm
Steel element thickness	14	mm

Analysis

Analysis	Existing	Limit	Unit	Utilization
Width 2	300	100	mm	33%
Thickness 2	126	32	mm	25%
F_v	4543.161	4661.69	N	97%
F_x	870.553	3885.229	N	22%
Combination	1	1	-	100%
Count	8.719	50	Count / m	17%



Diplomski rad
 Spoj CLT panela na čeličnu gredu
 Monika Spajić

2/4
 10/09/2024

Structural system

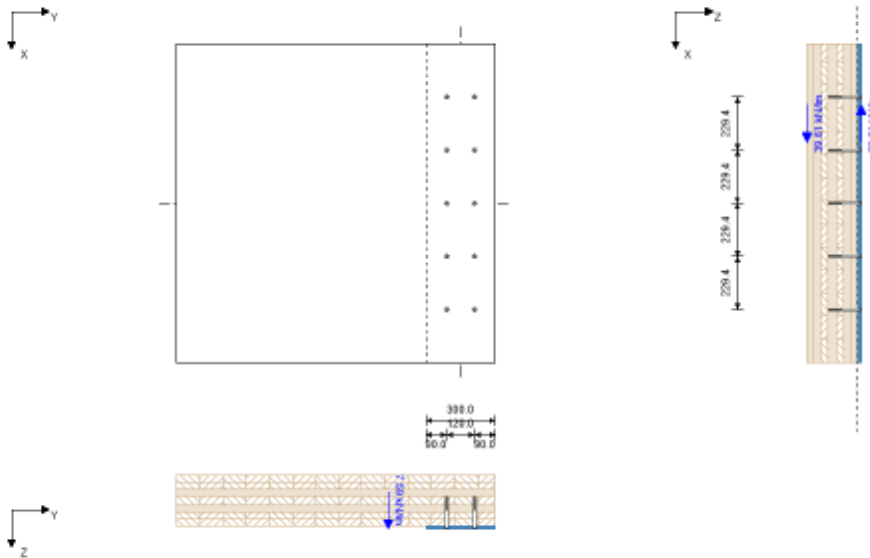

Minimum spacing						
Name	$a_{1,min}$	$a_{2,min}$	$a_{3c,min}$	$a_{3,min}$	$a_{4c,min}$	$a_{4,min}$
	[mm]	[mm]	[mm]	[mm]	[mm]	[mm]
CLT	40	25	60	60	25	60

Result in layers

Element 2						
X	Thick	Typ	α	l_{ef}	$l_{ef,v}$	$F_{ax,Rk}$
[mm]	[mm]		[°]	[mm]	[mm]	[N]
0	5	L	90	0	0	0
5	25	L	90	25	25	3157
30	25	L	90	25	25	3157
55	5	L	90	0	0	0
60	30	C	90	0	0	0
90	40	L	90	0	0	0
130	30	C	90	0	0	0
160	30	L	90	0	0	0
190	30	L	90	0	0	0

© 2024 - Calculatis by Stora Enso - Version 7.10.0
 Any use of results of the software is only allowed, if the results have been verified and approved regarding completeness and correctness by a project structural/building physics engineer. For more information see the Terms of Use.



Diplomski rad
 Spoj CLT panela na čeličnu gredu
 Monika Spajić

3/4
 10/09/2024

Results													
$b_{1,min}$	$b_{2,min}$	$f_{t,k,1}$	$f_{t,k,2}$	β	$t_{pen,1}$	$t_{pen,2}$	$l_{eR,1}$	$l_{eR,2}$	$t_{1,req}$	$t_{2,req}$	$F_{ax,Rk1}$	$F_{ax,Rk2}$	
[mm]	[mm]	[N/mm ²]	[N/mm ²]	[-]	[mm]	[mm]	[mm]	[mm]	[mm]	[mm]	[N]	[N]	
0	100	0.00	18.97	0.00	14.00	126.00	0.00	50.00	0	32	0.00	6313.50	

Results													
$M_{y,Rk}$	$F_{ax,Rk}$	$F_{head,Rk}$	$F_{tens,Rk}$	$F_{t,Rk}$	$F_{v,Rk}$	$F_{v,Rd}$	$F_{v,Ed}$	$F_{ax,Rd}$	$F_{ax,Ed}$	Count	Count _{max}	δ_{rel}	
[Nmm]	[N]	[N]	[kN]	[kN]	[N]	[N]	[kN/lm]	[N]	[kN/lm]	[Stk/m]	[Stk/m]	[mm]	
35829.64	6313.50	0.00	31.400	0.000	7575.25	4661.69	39.61	3885.23	7.59	8.72	50.00	229	

Reference documents for this analysis	
English title	Description
EN 338	EN 338 - Structural timber ? Strength classes
EN 1995-1-1	EN 1995-1-1 - Eurocode 5: Design of timber structures - Part 1-1: General ? Common rules and rules for buildings
EN 1990	EN 1990 - Eurocode ? Basis of structural design
ÖNorm B 1995-1-1 NA	ÖNORM EN 1995-1-1 - Austria - National Annex – Nationally determined parameters – Eurocode 5: Design of timber structures – Part 1-1: General-Common rules and rules for buildings
ÖNorm B 1995-1-2 NA	ÖNORM EN 1995-1-2 - Austria - National Annex - Eurocode 5: Design of timber structures ? Part 1-2: General ? Structural fire design ? National specifications concerning ÖNORM EN 1995-1-2, national comments and national supplements
ETA-11/0030	ETA-11/0030 European Technical Approval; Rothoblaas; Self-tapping screws for use in timber structures
ETA-12/0063	SFS intec AG; Self-tapping screws for use in timber constructions
ETA-12/0062	SFA intec AG; ETA-12/0062; selftapping screws for use in timber constructions
ETA-11/0086	GH Various Angle Brackets
ETA-09/0322	GH Various Angle Brackets
ETA-11/0496	Rotho Blaas TITAN Angle Brackets
ETA-11/0190	selftaping screw by Würth
ETA-12/0373	Schmid - Screws for use in timber constructions
ETA-12/0114	SPAX - Screws for use in timber constructions

© 2024 - Calculatis by Stora Enso - Version 7.10.0
 Any use of results of the software is only allowed, if the results have been verified and approved regarding completeness and correctness by a project structural/building physics engineer. For more information see the Terms of Use.



Diplomski rad
Spoj CLT panela na čeličnu gredu
Monika Spajčić

4/4
10/09/2024

Reference documents for this analysis

English title	Description
ETA-21/0670	Simpson Strong-Tie® Structural screws SWW, SWC, TTUFS, TTSFS and TTZNFS
ETA-13/0796	Simpson Strong-Tie® screws ESCR/ESCR-S, ESCRC/ESCRC-S, ESCRS, ESCRFTC, ESCRFT/FTZ, ESCRHD/HRD, ESCRT2R, SSTA and ESCRH
ETA-20/0773	Würth - DENEK Angle Brackets and plate connectors
ETA-08/0183	Würth - Typ A + Typ V Angle Bracket
ETA-14/0274	Würth - Hold down and storey connector

Disclaimer

The software was created to assist engineers in their daily business. The software is an engineering software that is dealing with a very complex matter of structural analysis and building physics analysis. Therefore, this software shall only be operated by skilled, experienced engineers, with a deep understanding of structural engineering and building physics related to timber structures. The user of the software is obliged to check all input values, no matter if they were given by the user or given by default by the software and all results for plausibility. The use of the results of the software should not be relied upon as the basis for any decision or action. Any use of results of the software is only allowed, if the results have been verified and approved regarding completeness and correctness by a project structural/building physics engineer. The user has the possibility to make print-outs from the software. Any modification of those are not allowed. Stora Enso Wood Products GmbH does not assume any warranty regarding the software. The software has been developed with utmost diligence, nevertheless Stora Enso Wood Products GmbH, neither expressly nor implicitly, provides any warranty in terms of accuracy, validity, timeliness and completeness of information and data created by the software. Stora Enso Wood Products GmbH does also not assume any warranty for the general usability of the software, its suitability for a special purpose or for the compatibility of the software with the ones of third party producers or providers. Stora Enso Wood Products GmbH is only liable for damages caused by gross negligence or intent through Stora Enso Wood Products GmbH; the liability for slight negligence is excluded. This does not apply to personal injury. Under the aforementioned conditions Stora Enso Wood Products GmbH is as well not liable for operational failures or the loss of programs and/or data of the user's data processing system. Applicable Law: These terms of use shall be governed by the laws of Austria excluding however any conflict of laws rules and any laws regarding the Convention of the International Sale of Goods (CISG).

Mjerodavni odabrani razmak spojnih sredstava je 200 mm.

4. ZAKLJUČAK

Kroz ovaj diplomski rad sam stekla bolje razumijevanje i osobno iskustvo u projektiranju drvenih konstrukcija, posebno križnolameliranog drva (CLT) i lameliranog drva (LLD). Projekt mi je omogućio da uvidim, ne samo tehničke aspekte inovativnih materijala, već i njihove potencijale u oblikovanju budućnosti građevinske industrije.

Prvi dojam koji sam dobila u radu s drvom, kao građevinskim materijalom, je da nudi jedinstvenu kombinaciju ekološke održivosti, energetske učinkovitosti i estetske privlačnosti. Njegovo korištenje u konstrukcijama, ne samo da doprinosi smanjenju emisije CO₂, već i omogućava bržu i manje energetske intenzivnu gradnju u usporedbi s tradicionalnim materijalima poput betona i čelika. Ovi materijali, iako su se dugo vremena smatrali standardom u građevinskoj industriji, imaju svoje limite koje drvo može prevladati, poput bržeg vremena gradnje i manjeg ekološkog utjecaja.

Na taj način, ne samo da možemo unaprijediti tehniku gradnje, već i pridonijeti stvaranju održivijih i ekološki prihvatljivijih građevinskih praksi za buduće generacije.

Zaključno, rad na ovom projektu mi je pokazao da je istraživanje i primjena novih materijala ključ za napredak i poboljšanje građevinskih metoda. Važno je da ne ostanemo zatvoreni u okvirima tradicionalnih materijala kao što su beton i čelik. Kao i u svakom aspektu života, kako bismo unaprijedili nešto, u ovom slučaju govorimo o gradnji i izboru građevinskih materijala, potrebno je dati priliku nečemu novom da bismo mogli unaprijediti postojeće. Samo kroz kontinuirano istraživanje i primjenu novih materijala možemo postići značajna poboljšanja u kvaliteti i održivosti građevinskih projekata.

Vjerujem da će daljnje istraživanje i razvoj drvenih konstrukcija dovesti do još većih inovacija u građevinskoj industriji, omogućujući nam da stvaramo bolje, održivije i učinkovitije konstrukcije.

POPIS LITERATURE

- [1] Jeleč, M., Varevac, D., Rajčić, V.: Križno lamelirano drvo (CLT) - pregled stanja područja, *GRAĐEVINAR*, 70 (2018) 2, pp. 75-95, doi: <https://doi.org/10.14256/JCE.2071.2017>
- [2] Bjelanović, A., Rajčić, V.: Drvene konstrukcije prema europskim normama. Hrvatska Sveučilišna naklada : Građevinski fakultet Sveučilišta u Zagrebu, Zagreb, 2005.
- [3] <http://seizkarta.gfz.hr/karta.php>.
- [4] Plates and connectors for timber, Rothoblaas
- [5] Brandner, R., Flatscher, G., Ringhofer, A., Schickhofer, G., & Thiel, A. (2016). Cross laminated timber (CLT): overview and development. *European Journal of Wood and Wood Products*, 74(3). <https://doi.org/10.1007/s00107-015-0999-5>
- [6] <https://www.wsp.com/en-gl/projects/55-southbank>
- [7] <https://radman-homes.eu/clt-gradnja-sto-je-i-koje-su-prednosti/>

POPIS SLIKA

- Slika 1.1. Oslobađanje CO₂ – konvencionalna gradnja / drvena gradnja*
- Slika 1.2. Slaganje lamela u CLT panelu ovisno o vrsti elementa za koji je korišten*
- Slika 1.3. Postupak proizvodnje CLT elementa*
- Slika 1.4. Geometrijske karakteristike CLT elementa za djelovanje okomito na ravninu elementa (lijevo) i djelovanje u ravnini elementa (desno)*
- Slika 1.5. Mjøstårnet u Norveškoj – vanjski dizajn i stepenište*
- Slika 1.6. Hoho toranj u Beču, Austrija*
- Slika 1.7. Southbank building – Melbourne, Australija*
- Slika 3.1. Pogled na konstrukciju - sjeverozapad*
- Slika 3.2. Pogled na konstrukciju – jug*
- Slika 3.3. Detalj vanjskih prolaza između stanova na južnoj i istaka zidova na sjevernoj strani*
- Slika 3.4. Prikaz modela – Dlubal RFEM*
- Slika 3.5. Prikaz modela – Dlubal RFEM*
- Slika 3.3.1. Karta snježnih područja*
- Slika 3.3.2. Karakteristična opterećenja snijegom za snježna područja i pripadajuće nadmorske visine*
- Slika 3.3.3. Karta osnovne brzine vjetra*
- Slika 3.3.4. Koeficijent izloženosti*
- Slika 3.3.5. Koeficijenti vanjskog tlaka za vertikalne zidove građevina pravokutnog tlocrta*
- Slika 3.3.6. Koeficijenti vanjskog tlaka za ravne krovove*
- Slika 3.3.7. Opterećenje vjetrom [kN/m²]: Slučaj 1 – transverzalni tlak, cpi = + 0,2*
- Slika 3.3.8. Opterećenje vjetrom [kN/m²]: Slučaj 2 – transverzalni tlak, cpi = - 0,3*
- Slika 3.3.9. Opterećenje vjetrom [kN/m²]: Slučaj 3 – longitudinalni tlak, cpi = + 0,2*
- Slika 3.3.10. Opterećenje vjetrom [kN/m²]: Slučaj 4 – longitudinalni tlak, cpi = - 0,3*
- Slika 3.3.11. Prikaz povratnih perioda i ubrzanja tla za odabranu lokaciju*
- Slika 3.3.12. Elastični spektar odziva Tipa 1*
- Slika 3.3.13. Odabrani faktor ponašanja za drvene konstrukcije prema HRN EN 1998-1*

PRILOZI

001 – Tlocrt prizemlja, MJ 1:200

002 – Tlocrt 1.kata MJ 1:200

003 – Tlocrt 2.kata MJ 1:200

004 – Tlocrt 3.kata MJ 1:200

005 – Tlocrt 4. kata MJ 1:200

006 – Tlocrt 5.kata MJ 1:200

007 – Plan pozicija panela prizemlja MJ 1:200

008 – Plan pozicija panela 1. i 3. kata MJ 1:200

009 – Plan pozicija panela 2. kata MJ 1:200

010 – Plan pozicija panela 4. kata MJ 1:200

011 – Plan pozicija panela 5. kata - krova MJ 1:200

012 – Plan pozicija prizemlja MJ 1:200

013 – Plan pozicija 1. i 3. kata MJ 1:200

014 – Plan pozicija 2. i 4. kata MJ 1:200

015 – Plan pozicija 5. kata MJ 1:200

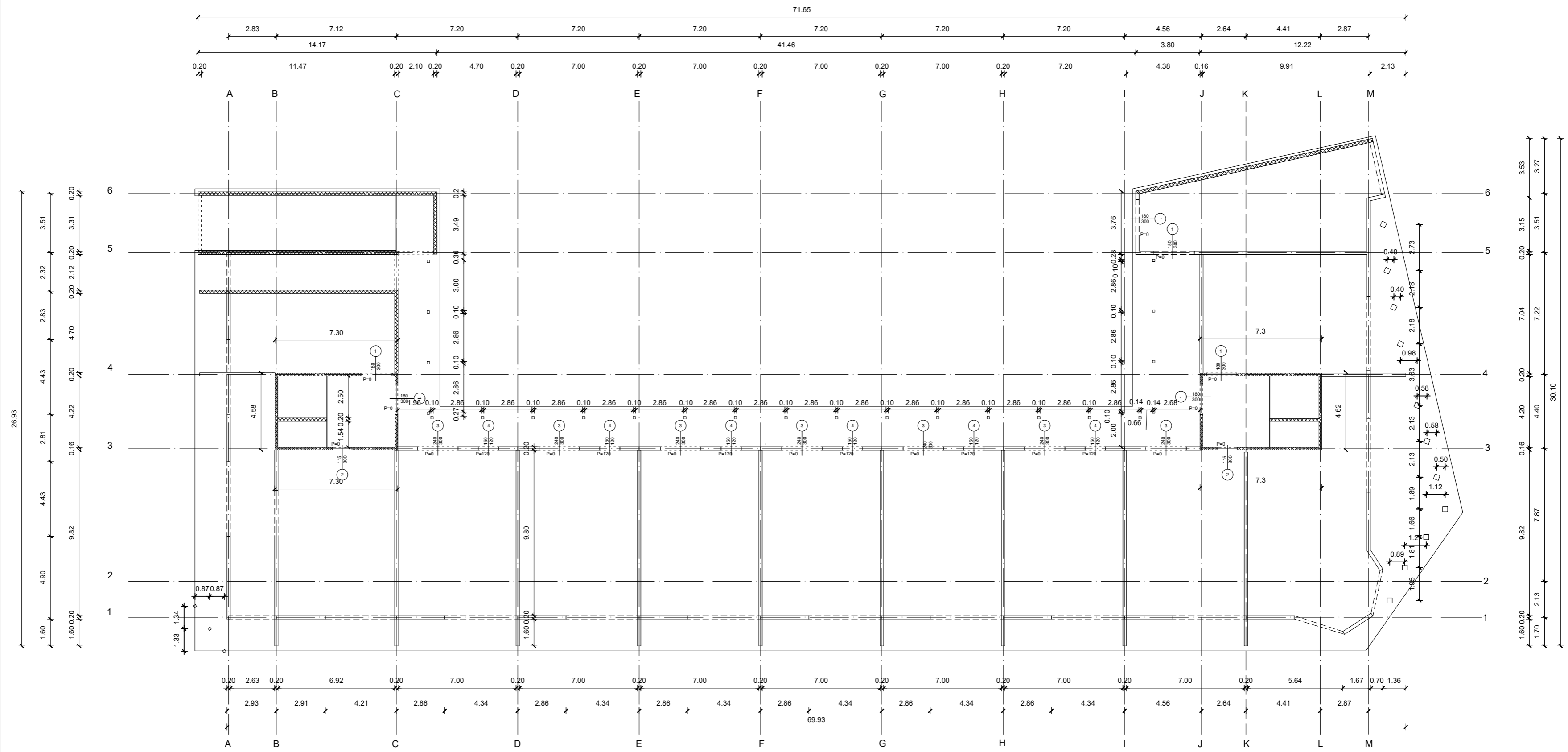

SVEUČILIŠTE U ZAGREBU GRAĐEVINSKI FAKULTET		DIPLOMSKI RAD	
Razina obrade:	Projekt konstrukcije	Kolegij:	Drvene konstrukcije 2.
Građevina:	Stambeno poslovna zgrada P + 5 od CLT-a	Akad. godina:	2023./2024.
Sadržaj nacrt:	Tlocrt prizemlja	Datum:	17.09.2024.
Mentorica:	prof.dr.sc. Vlatka Rajčić	Mjerilo:	1:200
Izradila:	Monika Spajić	Broj nacrt:	001

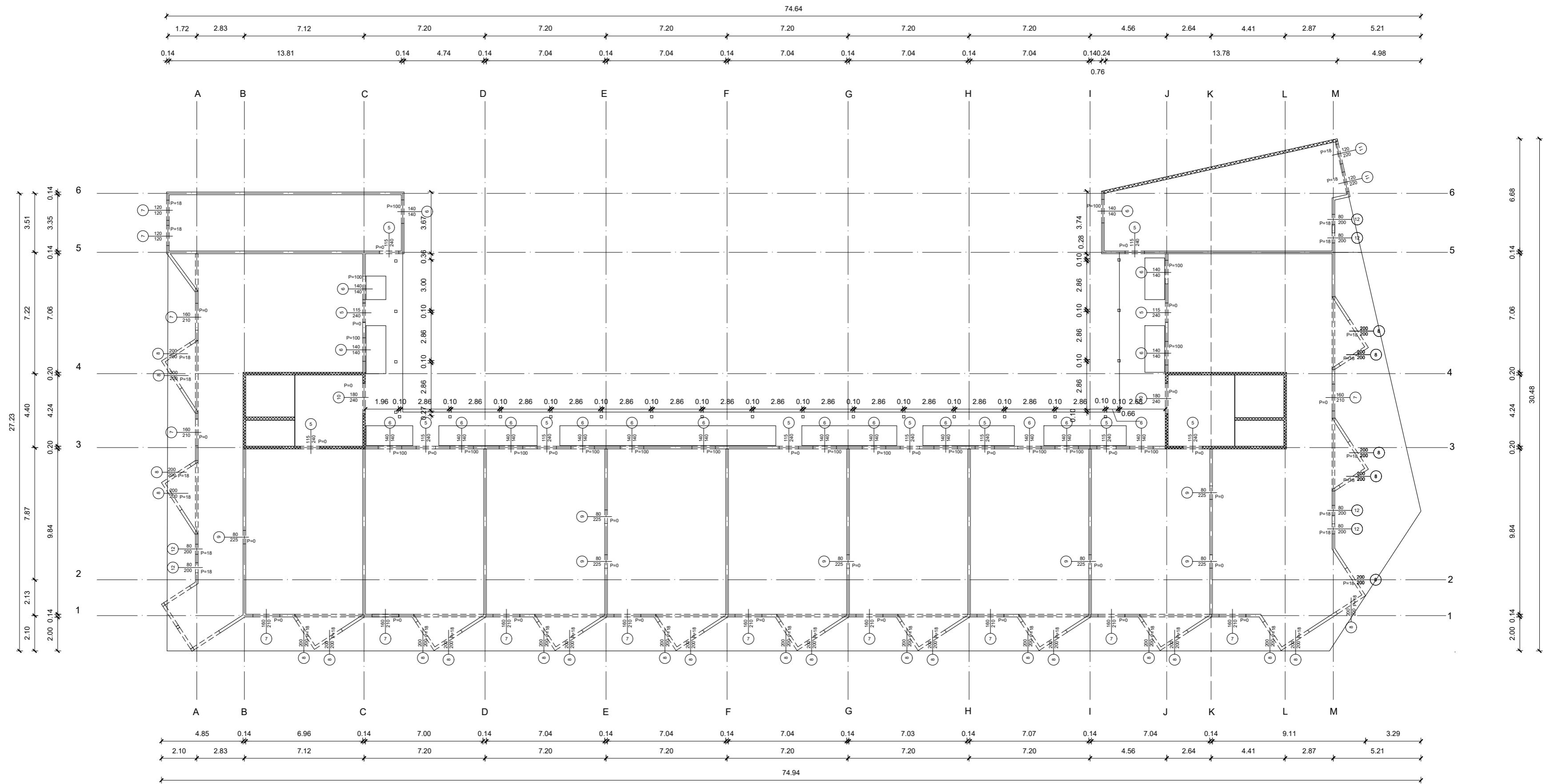

SVEUČILIŠTE U ZAGREBU GRAĐEVINSKI FAKULTET		DIPLOMSKI RAD	
Razina obrade:	Projekt konstrukcije	Kolegij:	Drvene konstrukcije 2.
Građevina:	Stambeno poslovna zgrada P + 5 od CLT-a	Akad. godina:	2023./2024.
Sadržaj nacрта:	Tloctrt 1. kata	Datum:	17.09.2024.
Mentorica:	prof.dr.sc. Vlatka Rajčić	Mjerilo:	1:200
Izradila:	Monika Spajić	Broj nacрта:	002

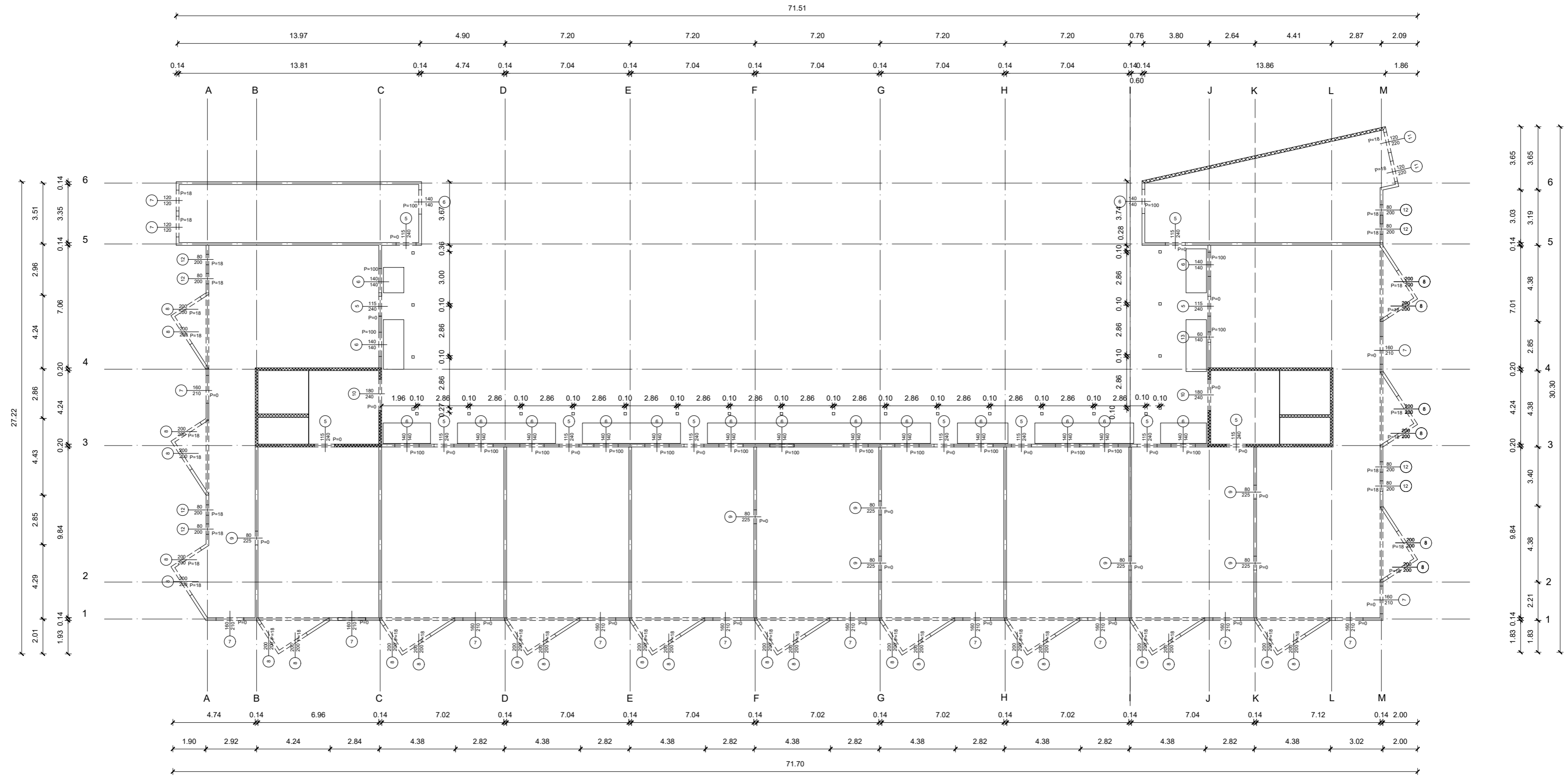

SVEUČILIŠTE U ZAGREBU GRAĐEVINSKI FAKULTET		DIPLOMSKI RAD	
Razina obrade:	Projekt konstrukcije	Kolegij:	Drvene konstrukcije 2.
Građevina:	Stambeno poslovna zgrada P + 5 od CLT-a	Akad. godina:	2023./2024.
Sadržaj nacрта:	Tlocrt 2. kata	Datum:	17.09.2024.
Mentorica:	prof.dr.sc. Vlatka Rajčić	Mjerilo:	1:200
Izradila:	Monika Spajić	Broj nacрта:	003

71.51

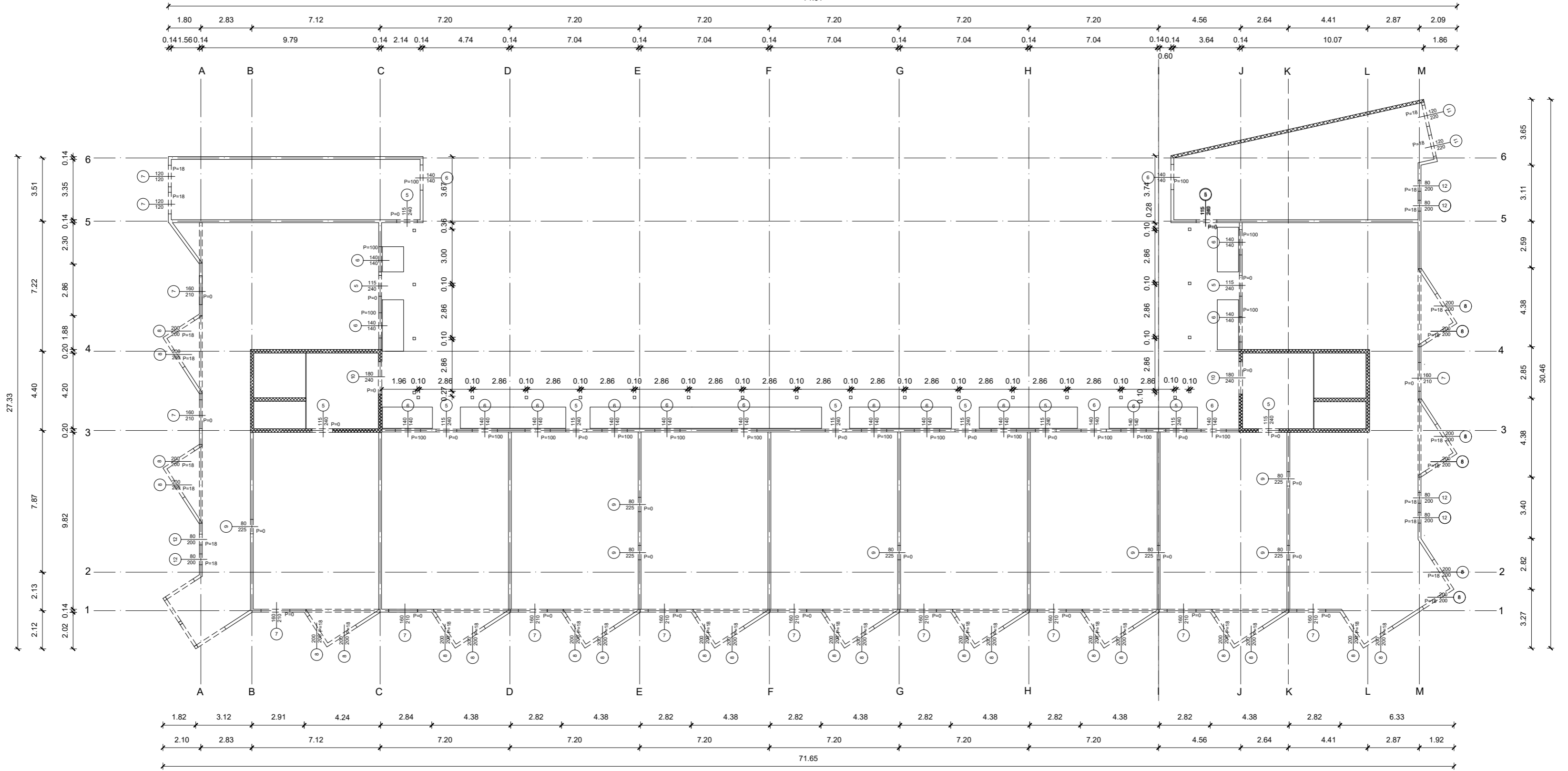

SVEUČILIŠTE U ZAGREBU GRAĐEVINSKI FAKULTET		DIPLOMSKI RAD	
Razina obrade:	Projekt konstrukcije	Kolegij:	Drvene konstrukcije 2.
Građevina:	Stambeno poslovna zgrada P + 5 od CLT-a	Akad. godina:	2023./2024.
Sadržaj nacрта:	Tlocrt 3. kata	Datum:	17.09.2024.
Mentorica:	prof.dr.sc. Vlatka Rajčić	Mjerilo:	1:200
Izradila:	Monika Spajić	Broj nacрта:	004

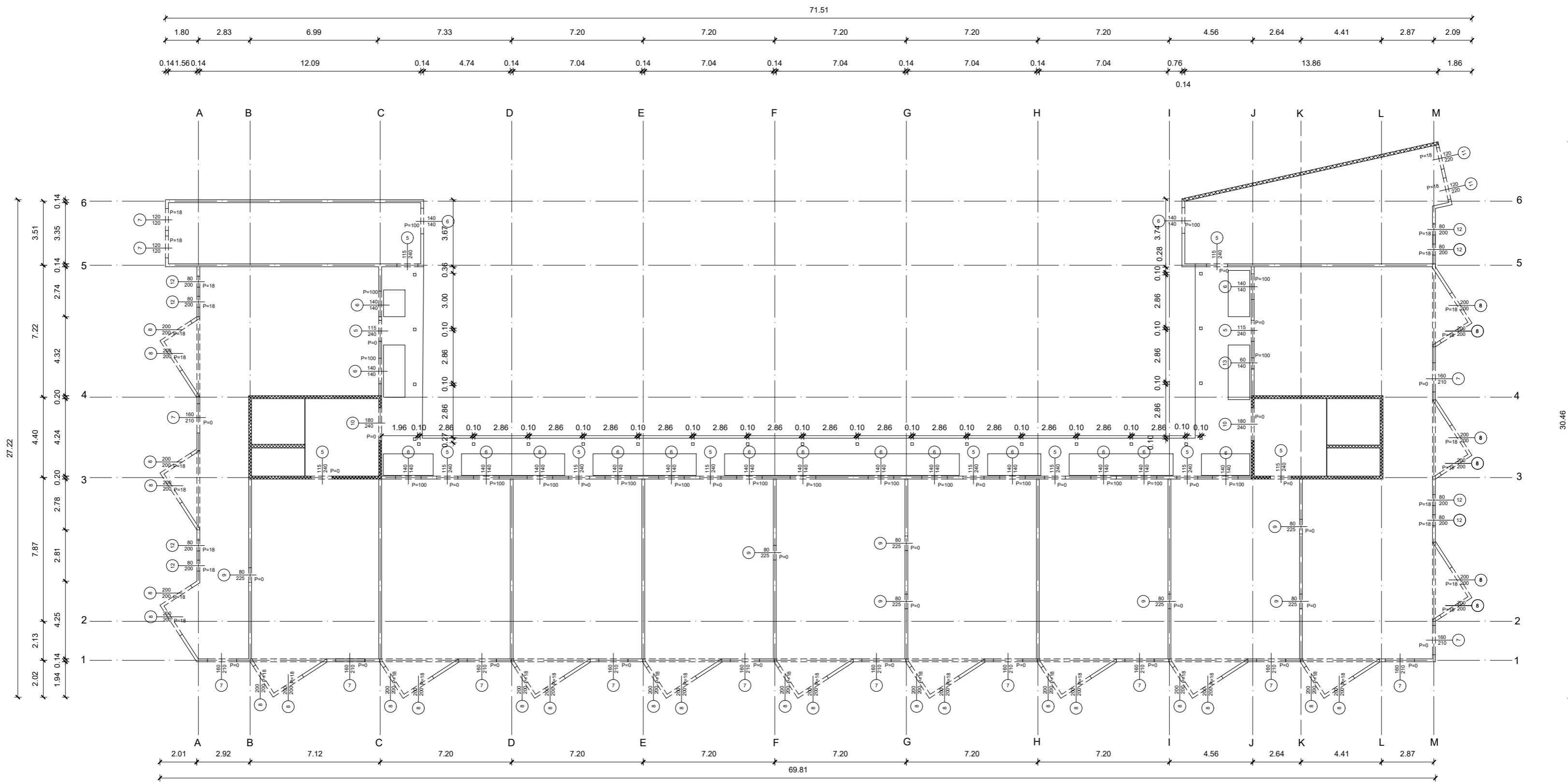

SVEUČILIŠTE U ZAGREBU GRAĐEVINSKI FAKULTET		DIPLOMSKI RAD	
Razina obrade:	Projekt konstrukcije	Kolegij:	Drvene konstrukcije 2.
Građevina:	Stambeno poslovna zgrada P + 5 od CLT-a	Akad. godina:	2023./2024.
Sadržaj nacрта:	Tloct 4. kata	Datum:	17.09.2024.
Mentorica:	prof.dr.sc. Vlatka Rajčić	Mjerilo:	1:200
Izradila:	Monika Spajić	Broj nacрта:	005

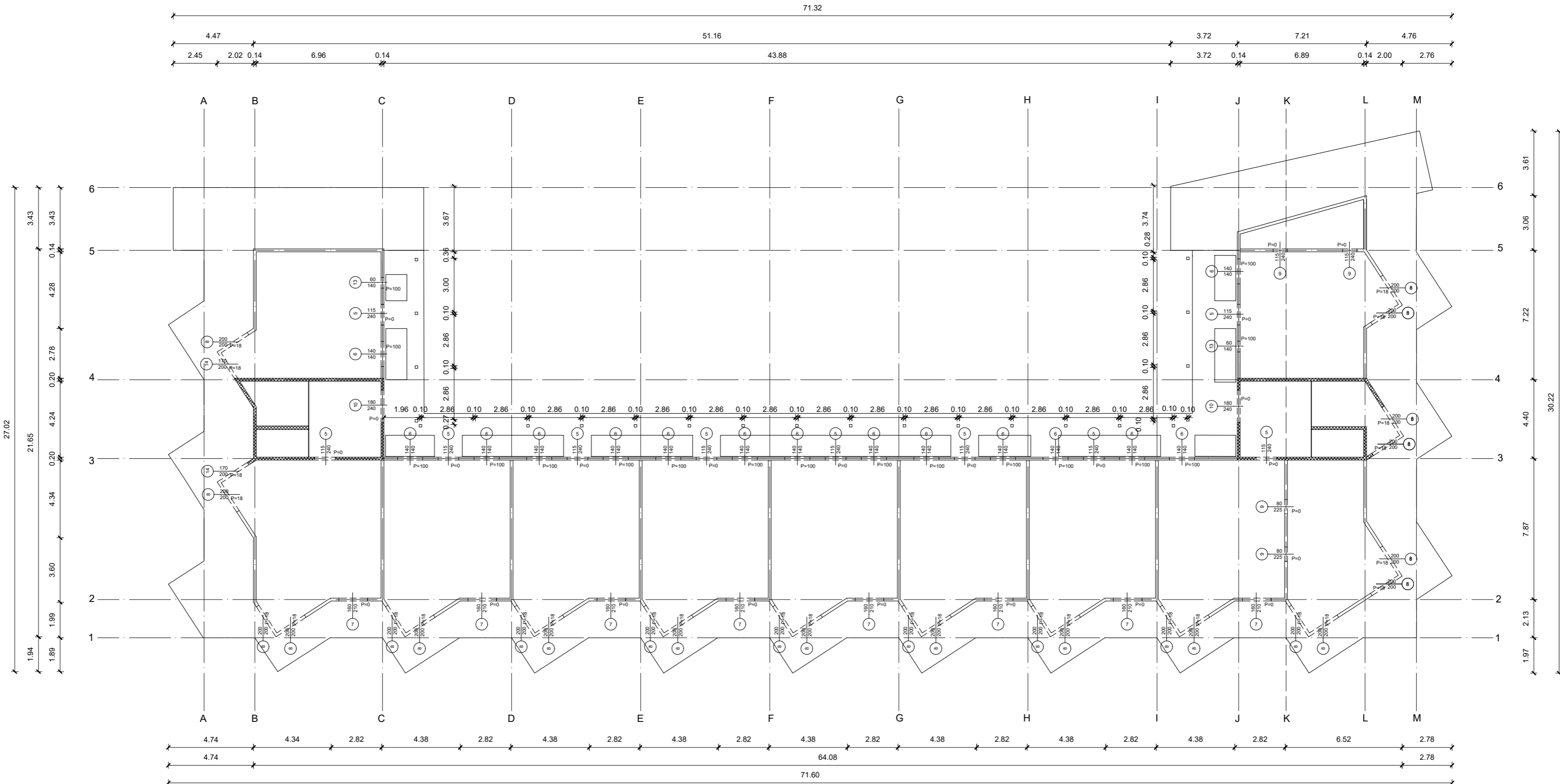

SVEUČILIŠTE U ZAGREBU GRAĐEVINSKI FAKULTET		DIPLOMSKI RAD	
Razina obrade:	Projekt konstrukcije	Kolegij:	Drvene konstrukcije 2.
Građevina:	Stambeno poslovna zgrada P + 5 od CLT-a	Akad. godina:	2023./2024.
Sadržaj nacrt:	Tlocrt 5.kata	Datum:	17.09.2024.
Mentorica:	prof.dr.sc. Vlatka Rajčić	Mjerilo:	1:200
Izradila:	Monika Spajić	Broj nacrt:	006

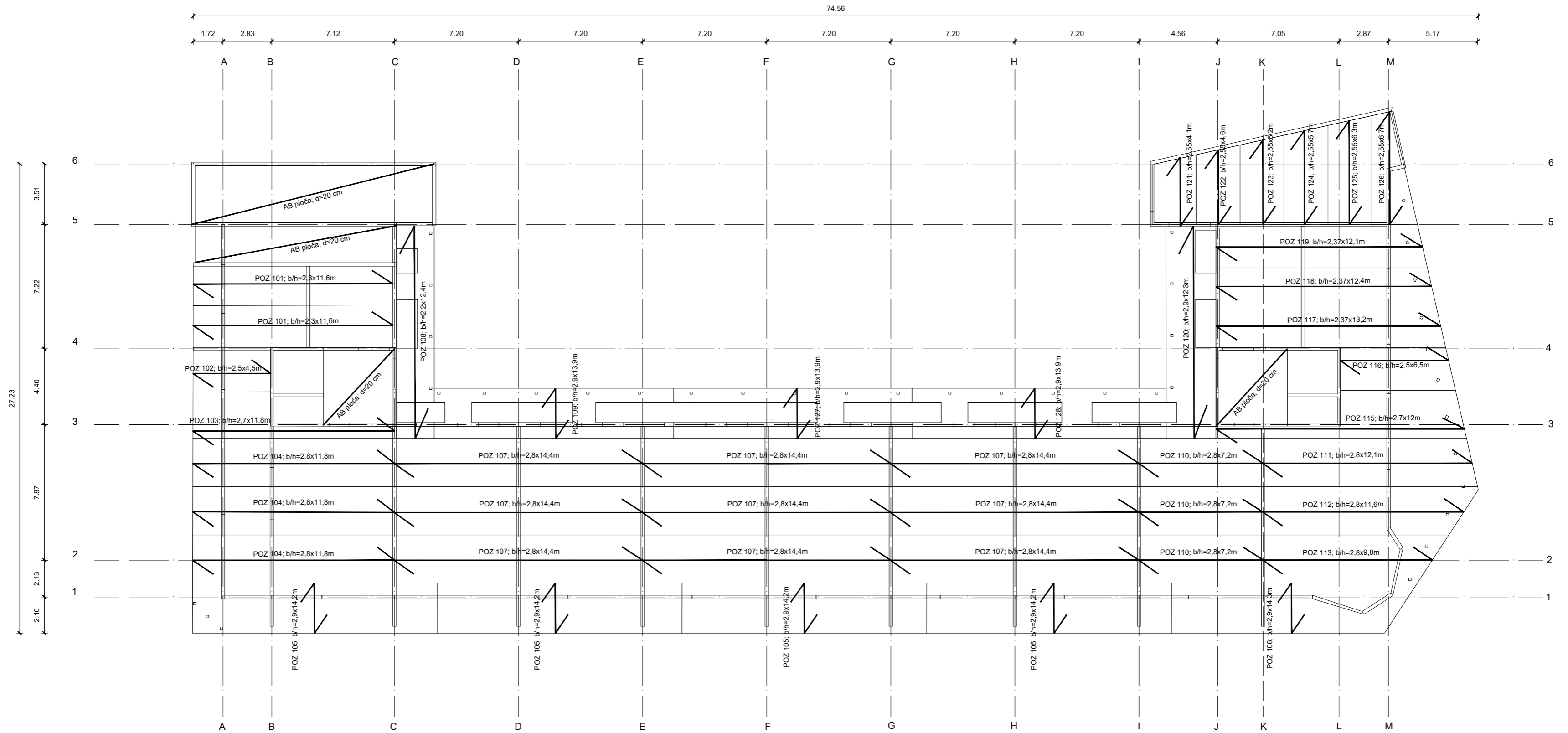

POZ 101-128
CLT međukatni paneli - d = 220 mm; 7 slojeva; C24

	30 mm
	30 mm
	30 mm
	40 mm
	30 mm
	30 mm
	30 mm

SVEUČILIŠTE U ZAGREBU GRAĐEVINSKI FAKULTET		DIPLOMSKI RAD	
Razina obrade:	Projekt konstrukcije	Kolegij:	Drvene konstrukcije 2.
Građevina:	Stambeno poslovna zgrada P + 5 od CLT-a	Akad. godina:	2023./2024.
Sadržaj nacрта:	Plan pozicija panela prizemlja	Datum:	17.09.2024.
Mentorica:	prof.dr.sc. Vlatka Rajčić	Mjerilo:	1:200
Izradila:	Monika Spajić	Broj nacрта:	007

71.27

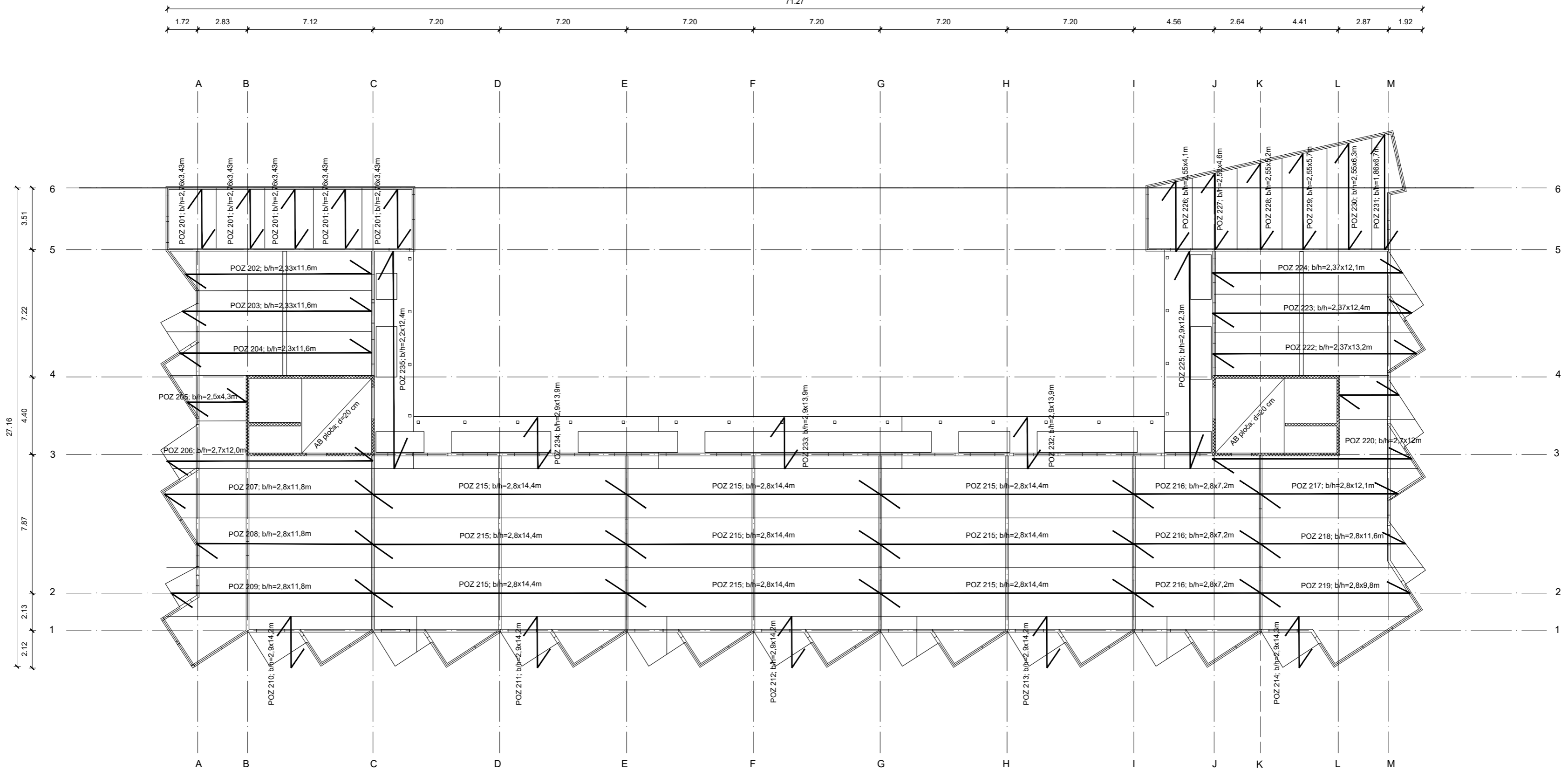

POZ 201-235
CLT međukatni paneli - d = 220 mm; 7 slojeva; C24

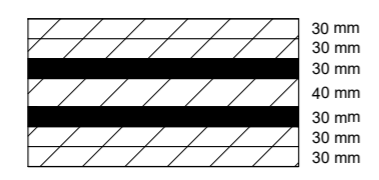

SVEUČILIŠTE U ZAGREBU GRAĐEVINSKI FAKULTET		DIPLOMSKI RAD	
Razina obrade:	Projekt konstrukcije	Kolegij:	Drvene konstrukcije 2.
Građevina:	Stambeno poslovna zgrada P + 5 od CLT-a	Akad. godina:	2023./2024.
Sadržaj nacрта:	Plan pozicija panela 1. i 3. kata	Datum:	17.09.2024.
Mentorica:	prof.dr.sc. Vlatka Rajčić	Mjerilo:	1:200
Izradila:	Monika Spajić	Broj nacрта:	008

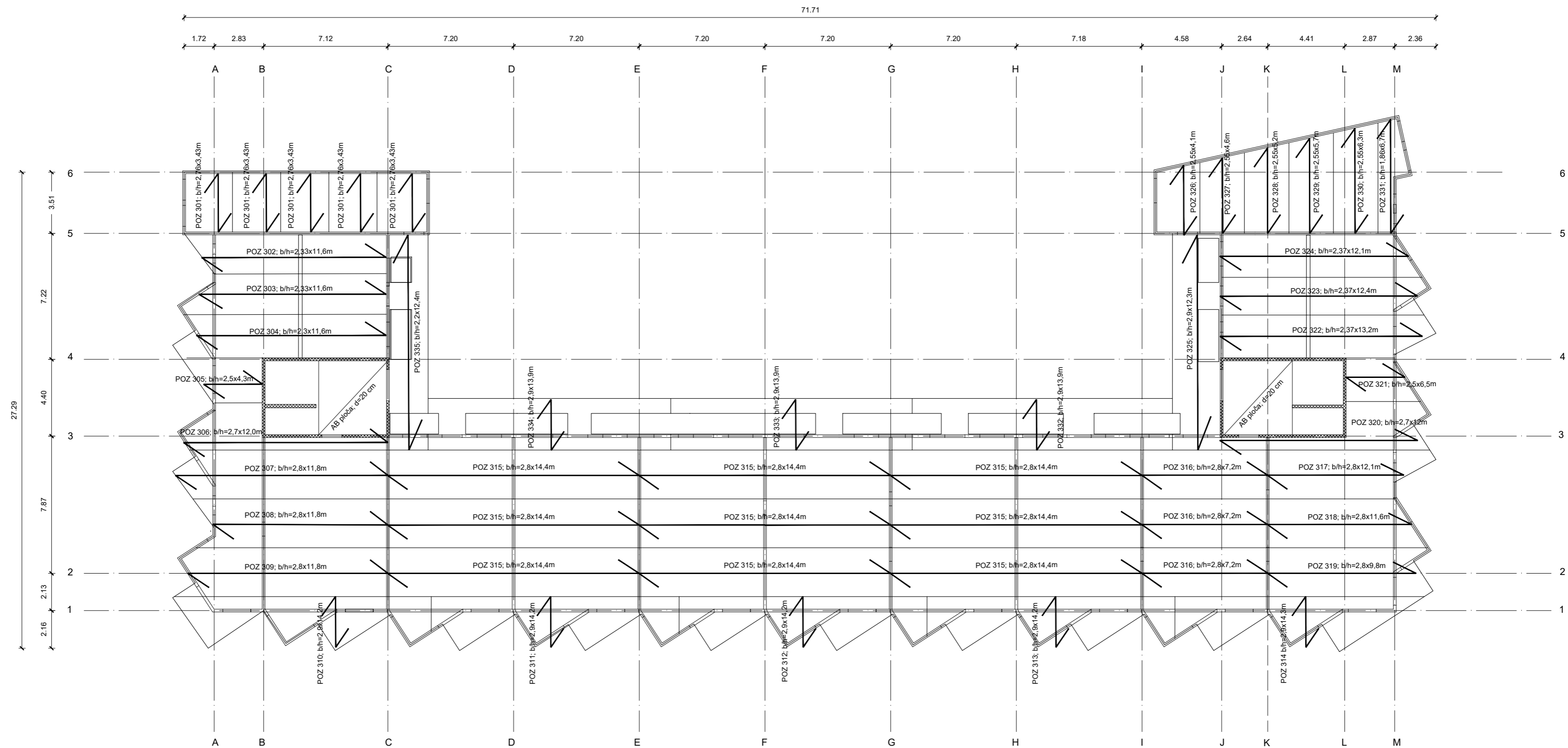

POZ 301-335
CLT međukatni paneli - d = 220 mm; 7 slojeva; C24

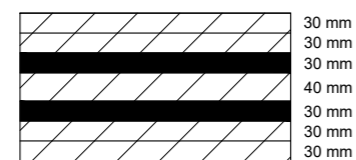

SVEUČILIŠTE U ZAGREBU GRAĐEVINSKI FAKULTET		DIPLOMSKI RAD	
Razina obrade:	Projekt konstrukcije	Kolegij:	Drvene konstrukcije 2.
Građevina:	Stambeno poslovna zgrada P + 5 od CLT-a	Akad. godina:	2023./2024.
Sadržaj nacрта:	Plan pozicija panela 2. kata	Datum:	17.09.2024.
Mentorica:	prof.dr.sc. Vlatka Rajčić	Mjerilo:	1:200
Izradila:	Monika Spajić	Broj nacрта:	009

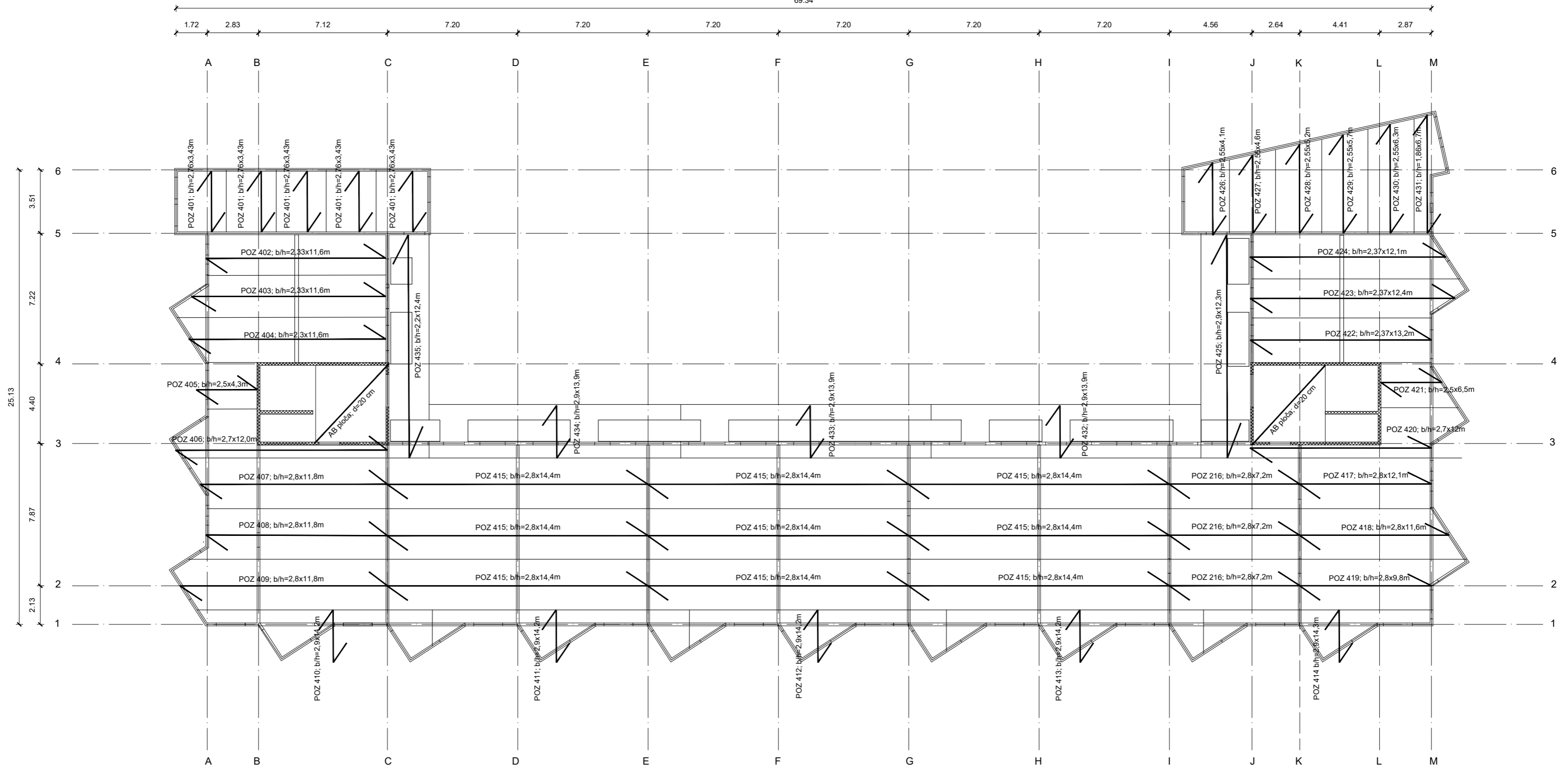

POZ 401-435
CLT međukatni paneli - d = 220 mm; 7 slojeva; C24

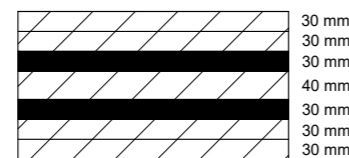

SVEUČILIŠTE U ZAGREBU GRAĐEVINSKI FAKULTET		DIPLOMSKI RAD	
Razina obrade:	Projekt konstrukcije	Kolegij:	Drvene konstrukcije 2.
Građevina:	Stambeno poslovna zgrada P + 5 od CLT-a	Akad. godina:	2023./2024.
Sadržaj nacрта:	Plan pozicija panela 4. kata	Datum:	17.09.2024.
Mentorica:	prof.dr.sc. Vlatka Rajčić	Mjerilo:	1:200
Izradila:	Monika Spajić	Broj nacрта:	010

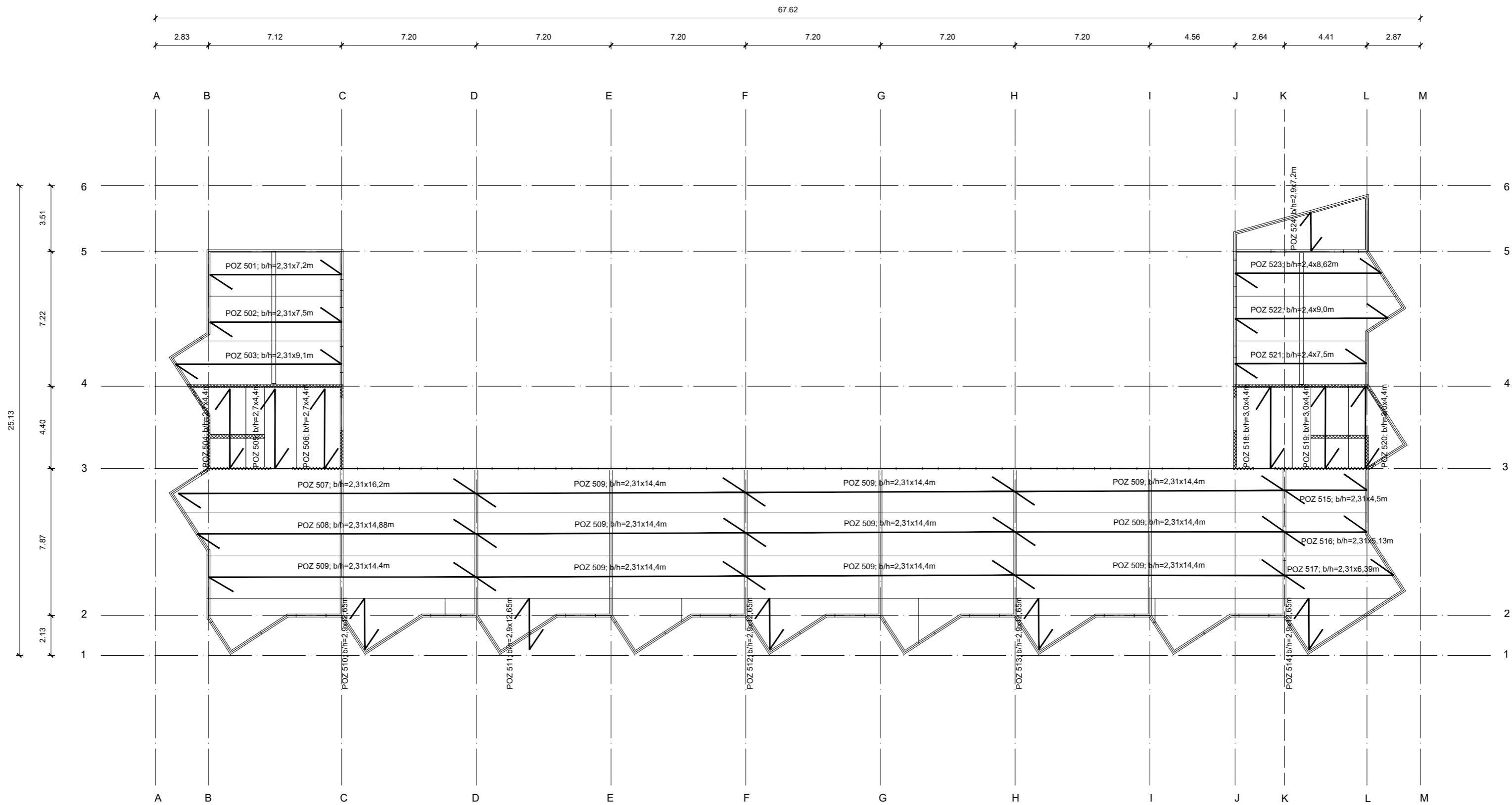

POZ 501-524
 CLT međukatni paneli - d = 220 mm; 7 slojeva; C24

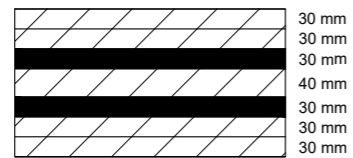

SVEUČILIŠTE U ZAGREBU GRAĐEVINSKI FAKULTET		DIPLOMSKI RAD	
Razina obrade:	Projekt konstrukcije	Kolegij:	Drvene konstrukcije 2.
Građevina:	Stambeno poslovna zgrada P + 5 od CLT-a	Akad. godina:	2023./2024.
Sadržaj nacrt:	Plan pozicija panela 5. kata - krova	Datum:	17.09.2024.
Mentorica:	prof.dr.sc. Vlatka Rajčić	Mjerilo:	1:200
Izradila:	Monika Spajić	Broj nacrt:	011

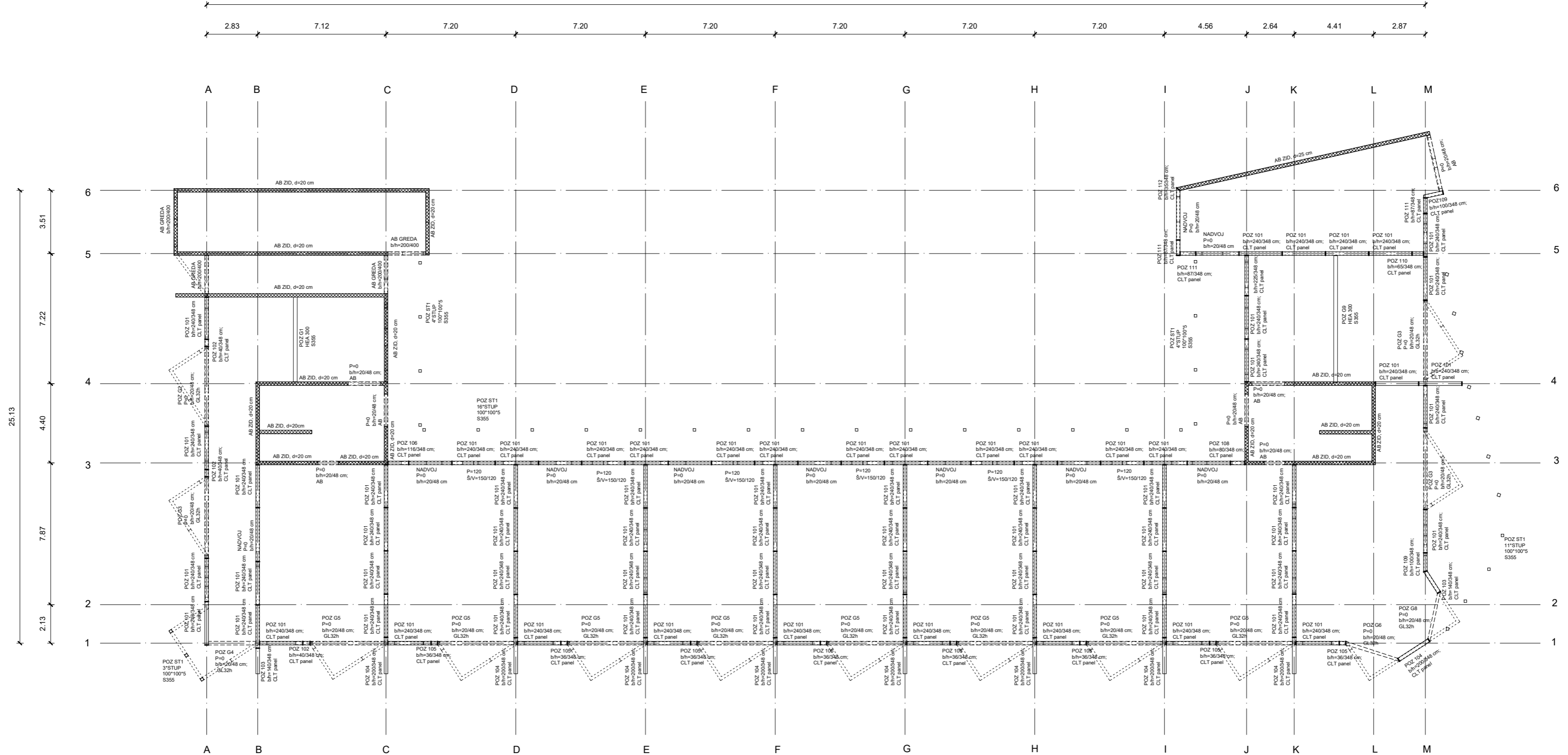

CLT zidni paneli - d = 200 mm; 5 slojeva; C24

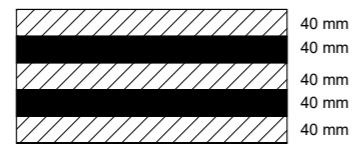

Napomena:
Dominantni smjer nosivosti zidnih panela je vertikalni.

SVEUČILIŠTE U ZAGREBU GRAĐEVINSKI FAKULTET		DIPLOMSKI RAD	
Razina obrade:	Projekt konstrukcije	Kolegij:	Drvene konstrukcije 2.
Građevina:	Stambeno poslovna zgrada P + 5 od CLT-a	Akad. godina:	2023./2024.
Sadržaj nacрта:	Plan pozicija prizemlja	Datum:	17.09.2024.
Mentorica:	prof.dr.sc. Vlatka Rajčić	Mjerilo:	1:200
Izradila:	Monika Spajić	Broj nacрта:	012

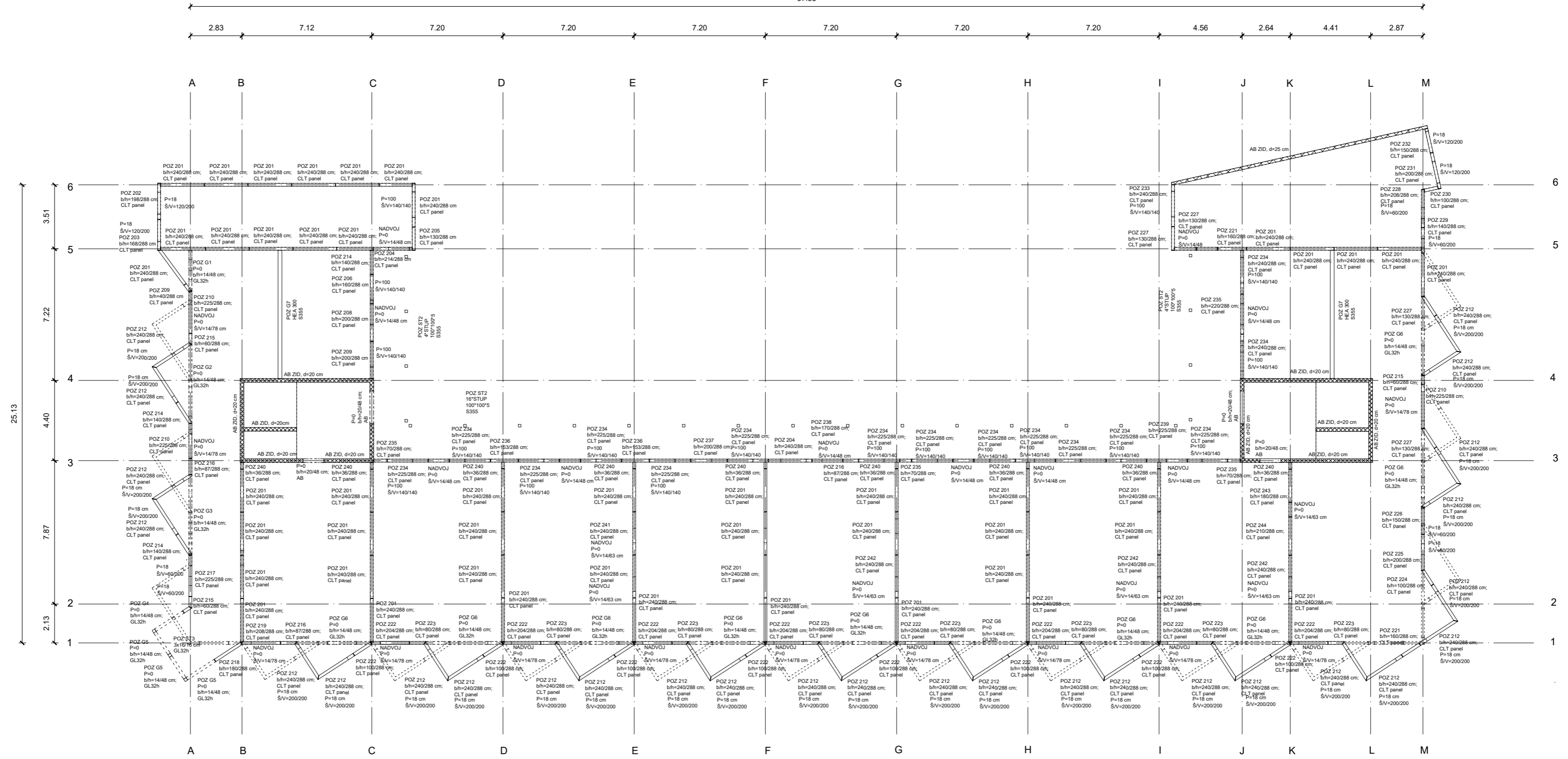

CLT zidni paneli - d =140 mm; 5 slojeva; C24

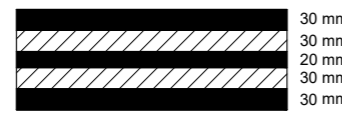

Napomena:
Dominantni smjer nosivosti zidnih panela je vertikalni, osim zidova pozicija 212, 218, 222 i 227.

SVEUČILIŠTE U ZAGREBU GRAĐEVINSKI FAKULTET		DIPLOMSKI RAD	
Razina obrade:	Projekt konstrukcije	Kolegij:	Drvene konstrukcije 2.
Građevina:	Stambeno poslovna zgrada P + 5 od CLT-a	Akad. godina:	2023./2024.
Sadržaj nacрта:	Plan pozicija 1. i 3. kata	Datum:	17.09.2024.
Mentorica:	prof.dr.sc. Vlatka Rajčić	Mjerilo:	1:200
Izradila:	Monika Spajić	Broj nacрта:	013

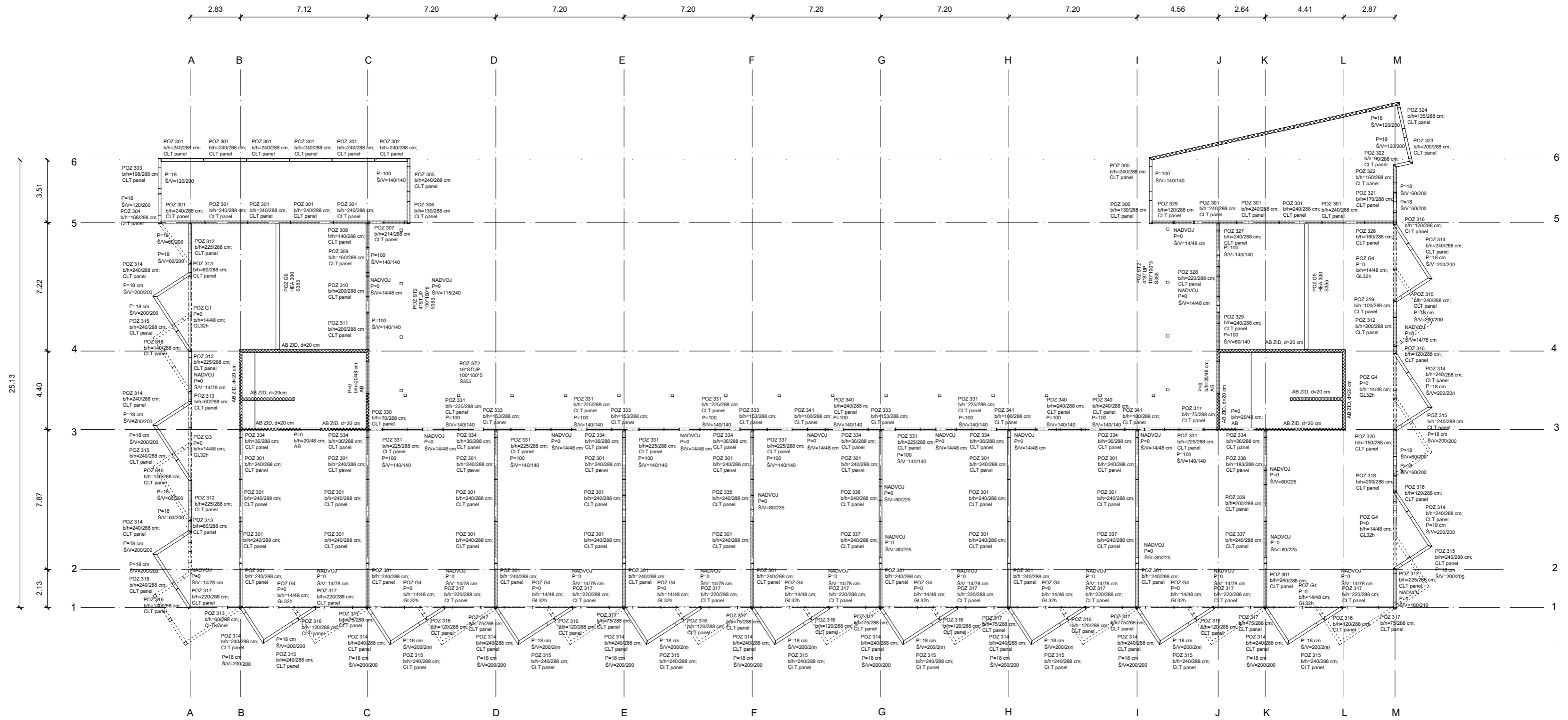

CLT zidni paneli - d =140 mm; 5 slojeva; C24

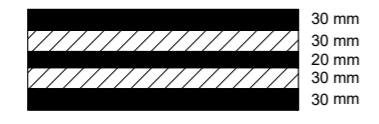

Napomena:
Dominantni smjer nosivosti zidnih panela je vertikalni, osim zidova pozicija 314,315 i 316.

SVEUČILIŠTE U ZAGREBU GRAĐEVINSKI FAKULTET		DIPLOMSKI RAD	
Razina obrade:	Projekt konstrukcije	Kolegij:	Drvene konstrukcije 2.
Građevina:	Stambeno poslovna zgrada P + 5 od CLT-a	Akad. godina:	2023./2024.
Sadržaj nacрта:	Plan pozicija 2. i 4. kata	Datum:	17.09.2024.
Mentorica:	prof.dr.sc. Vlatka Rajčić	Mjerilo:	1:200
Izradila:	Monika Spajić	Broj nacрта:	014

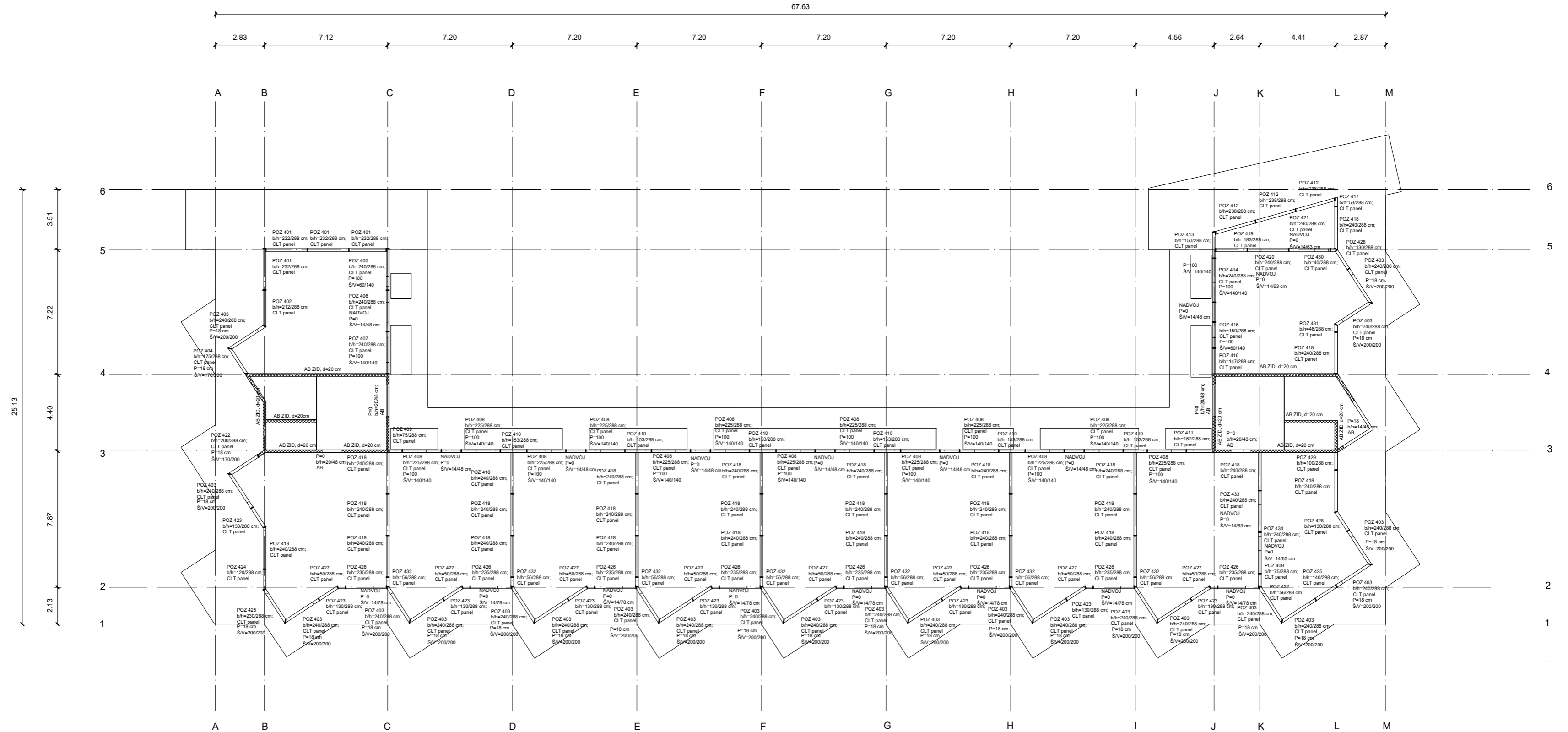

CLT zidni paneli - d =140 mm; 5 slojeva; C24

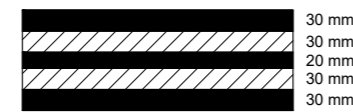

Napomena:
Dominantni smjer nosivosti zidnih panela je vertikalni.

SVEUČILIŠTE U ZAGREBU GRAĐEVINSKI FAKULTET		DIPLOMSKI RAD	
Razina obrade:	Projekt konstrukcije	Kolegij:	Drvene konstrukcije 2.
Građevina:	Stambeno poslovna zgrada P + 5 od CLT-a	Akad. godina:	2023./2024.
Sadržaj nacрта:	Plan pozicija 5.kata	Datum:	17.09.2024.
Mentorica:	prof.dr.sc. Vlatka Rajčić	Mjerilo:	1:200
Izradila:	Monika Spajić	Broj nacрта:	015