

# Road and Rail Infrastructure IV

---

## Edited book / Urednička knjiga

Publication status / Verzija rada: **Published version / Objavljena verzija rada (izdavačev PDF)**

Publication year / Godina izdavanja: **2016**

Permanent link / Trajna poveznica: <https://urn.nsk.hr/urn:nbn:hr:237:968569>

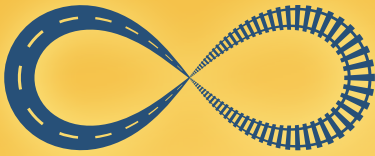
Rights / Prava: [In copyright](#) / [Zaštićeno autorskim pravom.](#)

Download date / Datum preuzimanja: **2024-06-24**

Repository / Repozitorij:

[Repository of the Faculty of Civil Engineering,  
University of Zagreb](#)





**CETRA**<sup>2016</sup>

4<sup>th</sup> International Conference on Road and Rail Infrastructure  
23-25 May 2016, Šibenik, Croatia

## Road and Rail Infrastructure IV

Stjepan Lakušić – EDITOR

Organizer  
University of Zagreb  
Faculty of Civil Engineering  
Department of Transportation



**CETRA<sup>2016</sup>**

**4<sup>th</sup> International Conference on Road and Rail Infrastructure**  
23–25 May 2016, Šibenik, Croatia

TITLE

Road and Rail Infrastructure IV, Proceedings of the Conference CETRA 2016

EDITED BY

Stjepan Lakušić

ISSN

1848-9850

PUBLISHED BY

Department of Transportation  
Faculty of Civil Engineering  
University of Zagreb  
Kačićeva 26, 10000 Zagreb, Croatia

DESIGN, LAYOUT & COVER PAGE

minimum d.o.o.

Marko Uremović · Matej Korlaet

PRINTED IN ZAGREB, CROATIA BY

“Tiskara Zelina”, May 2016

COPIES

400

Zagreb, May 2016.

Although all care was taken to ensure the integrity and quality of the publication and the information herein, no responsibility is assumed by the publisher, the editor and authors for any damages to property or persons as a result of operation or use of this publication or use the information's, instructions or ideas contained in the material herein.

The papers published in the Proceedings express the opinion of the authors, who also are responsible for their content. Reproduction or transmission of full papers is allowed only with written permission of the Publisher. Short parts may be reproduced only with proper quotation of the source.

Proceedings of the  
4<sup>th</sup> International Conference on Road and Rail Infrastructures – CETRA 2016  
23–25 May 2016, Šibenik, Croatia

# Road and Rail Infrastructure IV

**EDITOR**

Stjepan Lakušić  
Department of Transportation  
Faculty of Civil Engineering  
University of Zagreb  
Zagreb, Croatia



CETRA<sup>2016</sup>

## 4<sup>th</sup> International Conference on Road and Rail Infrastructure

23–25 May 2016, Šibenik, Croatia

## ORGANISATION

### CHAIRMEN

Prof. Stjepan Lakušić, University of Zagreb, Faculty of Civil Engineering

Prof. emer. Željko Korlaet, University of Zagreb, Faculty of Civil Engineering

### ORGANIZING COMMITTEE

Prof. Stjepan Lakušić

Prof. emer. Željko Korlaet

Prof. Vesna Dragčević

Prof. Tatjana Rukavina

Assist. Prof. Ivica Stančerić

Assist. Prof. Saša Ahac

Assist. Prof. Maja Ahac

Ivo Haladin, PhD

Josipa Domitrović, PhD

Tamara Džambas

Viktorija Grgić

Šime Bezina

All members of CETRA 2016

Conference Organizing Committee

are professors and assistants

of the Department of Transportation,

Faculty of Civil Engineering

at University of Zagreb.

### INTERNATIONAL ACADEMIC SCIENTIFIC COMMITTEE

Davor Brčić, University of Zagreb

Dražen Cvitanić, University of Split

Sanja Dimter, Josip Juraj Strossmayer University of Osijek

Aleksandra Deluka Tibljaš, University of Rijeka

Vesna Dragčević, University of Zagreb

Rudolf Eger, RheinMain University

Makoto Fujii, Kanazawa University

Laszlo Gaspar, Institute for Transport Sciences (KTI)

Kenneth Gavin, University College Dublin

Nenad Gucunski, Rutgers University

Libor Izvolt, University of Zilina

Lajos Kisgyörgy, Budapest University of Technology and Economics

Stasa Jovanovic, University of Novi Sad

Željko Korlaet, University of Zagreb

Meho Saša Kovačević, University of Zagreb

Zoran Krakutovski, Ss. Cyril and Methodius University in Skopje

Stjepan Lakušić, University of Zagreb

Dirk Lauwers, Ghent University

Dragana Macura, University of Belgrade

Janusz Madejski, Silesian University of Technology

Goran Mladenović, University of Belgrade

Tomislav Josip Mlinarić, University of Zagreb

Nencho Nenov, University of Transport in Sofia

Mladen Nikšić, University of Zagreb

Dunja Perić, Kansas State University

Otto Plašek, Brno University of Technology

Carmen Racanel, Technological University of Civil Engineering Bucharest

Tatjana Rukavina, University of Zagreb

Andreas Schoebel, Vienna University of Technology

Adam Szeląg, Warsaw University of Technology

Francesca La Torre, University of Florence

Audrius Vaitkus, Vilnius Gediminas Technical University

## FOREWORD

The 4<sup>th</sup> International Conference on Road and Rail Infrastructure – CETRA 2016 was organized by the University of Zagreb – Faculty of Civil Engineering, Department of Transportation. The Conference is held in Šibenik, Croatia. Šibenik is the first town in the world to benefit from electric lighting. In fact, on 28 August 1895, the alternating current electric lighting was activated for the first time in the streets of Šibenik. The merit for this certainly goes to the inventor, visionary genius and researcher of Croatian descent, Nikola Tesla, whose alternating current discovery lighted up streets and squares of Šibenik. The Šibenik power plant was the first alternating current power system in Croatia, the first commercial hydro power plant in Europe, and the second one in the world. It was put in operation on 28 August 1895 at 20:00, two days after the Adams Power Plant on the Niagara Falls.

The 1<sup>st</sup> International Conference on Road and Rail Infrastructure – CETRA 2010 is held 17-18 May 2010 in Opatija. The 2<sup>nd</sup> International Conference on Road and Rail Infrastructure – CETRA 2012 is held on 7-9 May 2012 in Dubrovnik. The 3<sup>rd</sup> International Conference on Road and Rail Infrastructure – CETRA 2014 is held on 28-30 April 2014 in Split. Great interest of participants in topics from the field of road and rail infrastructure during the previous conferences CETRA, confirmed the soundness of Department for Transportation Engineering's decision on organizing such international event. Positive comments of the participants after the past Conferences motivated the Department for Transportation Engineering, Faculty of Civil Engineering at University of Zagreb to continue the organization of such an international event.

The CETRA conference has established itself as a venue where scientific and professional information from the field of road and rail infrastructure is exchanged. The idea on linking research organisations and economic sector has been the guiding concept for the realisation of this conference. Conferences of this kind are undoubtedly a proper place for bringing closer together the economy and university operators, and for facilitating communication and establishing greater confidence that might result in cooperation on new projects, especially those that contribute to greater competition. Lectures organized in the scope of the conference are based on interesting technical solutions and on new knowledge from the field of transport infrastructure as gained on already realised projects, projects currently at the planning stage, and those now under construction, in all parts of the world. In addition to authors from the academic community, lectures were also presented by practical authors, the idea being to ensure the best possible synergy between the theory and practice. Because of a great interest for the themes from the field of road and rail infrastructure, as shown during the past two conferences (CETRA 2010, CETRA 2012 and CETRA 2014), the Department for Transportation Engineering of the Faculty of Civil Engineering – Zagreb assumed the responsibility to organise the CETRA conference in this year as well.

Our goal for the International Conference on Road and Rail Infrastructure – CETRA is to have all published papers indexed in scientific databases in order to achieve greater recognition for the conference itself, for published papers, and for their authors. As the serial publication entitled Road and Rail Infrastructure has been achieved with last conference (CETRA 2014), the precondition has been fulfilled to obtain the International Standard Serial Number (ISSN), which was the condition for starting procedure for registering this publication in scientific databases. A great novelty is that the CETRA 2016 conference will be indexed in the TRID base, which is an integrated database that combines the records from TRB's Transportation Research Information Ser-vices (TRIS) Database, and the OECD's Joint Transport Research Centre's International Transport Research Documentation (ITRD) Database. TRID provides access to

more than one million records of transportation research worldwide. In addition, the TRID base has accepted all papers that were published at previous CETRA conferences.

In the year 2016, 4<sup>th</sup> International Conference on Road and Rail Infrastructure – CETRA 2016 has been organized, with the intention of bringing together scientists and experts in the fields of road and railway engineering, giving them another opportunity to present the results of their researches, findings and innovations as well as to analyze problems encountered in everyday engineering practice and to offer possible solutions for a more efficient planning, design, construction and maintenance of transport infrastructure.

Conference CETRA 2016 covers many areas: Traffic planning and modelling, Infrastructure projects, Infrastructure management, Road pavement, Rail track superstructure, Construction and maintenance, Transport geotechnics, Tunnels and bridges, Structural monitoring and maintenance, Computer techniques and simulations, Noise and vibration, Innovation and new technology, Urban transport, Integrated timetables on railways, Vehicles dynamics, Traffic safety and for the first time Traction Vehicles and Power Supply of Transport Systems. This Conference CETRA 2016 attracted a large number of papers and presentations from 37 countries and 54 Universities. More than 140 papers were presented at the Conference and are contained in these proceedings **Road and Rail Infrastructure IV**.

The organizers of the Conference express their thanks to all Businesses and Institutions which support this Conference. Special thanks are extended to the European Railway Agency (ERA), for their assistance and support in organizing very important conference sessions regarding **Interoperability of the European rail system** especially regarding 4<sup>th</sup> Railway Packages issues and Technical Specifications for Interoperability (TSI). The objective of ERA is to contribute, on technical matters, to the implementation of the European Union legislation aimed at improving the competitive position of the railway sector by enhancing the level of interoperability of railway systems, developing a common approach to safety on the European railway system and contributing to creating a Single European Railway Area without frontiers, guaranteeing a high level of safety.

The Editor commends all authors for excellent papers contributed to these proceedings, and wishes to thank members of the International Academic Scientific Committee, and numerous experts who participated in the review process. The gratitude is also extended to all participants for deciding to come to Šibenik and take part in CETRA 2016. We believe that these CETRA 2016 proceedings entitled Road and Rail Infrastructure IV will be, just like the preceding three proceedings from the CETRA cycle, highly interesting and useful to all experts exhibiting a scientific and professional interest in road and rail infrastructure.

THE EDITOR  
Prof. Stjepan Lakušić  
May, 2016.

## CONFERENCE SUPPORT

## Co-organizer and Support of the Conference



UNIVERSITY OF  
**ZAGREB**

University of Zagreb  
Trg maršala Tita 14, 10000 Zagreb, Croatia



Faculty of Civil Engineering  
University of Zagreb  
Kačićeva 26, 10000 Zagreb, Croatia  
[www.grad.hr](http://www.grad.hr)



MINISTRY OF MARITIME  
AFFAIRS, TRANSPORT  
AND INFRASTRUCTURE

Ministry of Maritime Affairs, Transport and Infrastructure  
Prisavlje 14, 10000 Zagreb, Croatia



MINISTRY OF SCIENCE,  
EDUCATION AND SPORTS

Minister of Science, Education and Sports  
Donje Svetice 38, 10000 Zagreb, Croatia



The city of Šibenik



European Railway Agency

European Railway Agency  
[www.era.europa.eu](http://www.era.europa.eu)

## Golden Sponsor



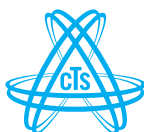
Department of Transportation Engineering  
Faculty of Civil Engineering  
University of Zagreb  
Kačićeva 26, 10000 Zagreb, Croatia  
[www.grad.hr](http://www.grad.hr)

## Silver Sponsor



CEMEX  
[www.cemex.hr](http://www.cemex.hr)

## Bronze Sponsors



CTS – Centar za tračničke sustave  
Boškovićeve 7, 10000 Zagreb  
[www.cts-rail.hr](http://www.cts-rail.hr)  
[info@cts-rail.hr](mailto:info@cts-rail.hr)

## TrgoVDM

Trgo VDM  
Trncevicev put 27, 10000 Zagreb  
[www.trgovdm.hr](http://www.trgovdm.hr)

## Media Partner

## GRAĐEVINAR

Journal of Croatian Association of Civil Engineers  
Berislavićeva 6, 10000 Zagreb, Croatia  
[www.casopis-gradjevinar.hr](http://www.casopis-gradjevinar.hr)  
[gradjevinar@hsgi.org](mailto:gradjevinar@hsgi.org)





# CONTENTS

## KEYNOTE LECTURE

VIRTUAL MANAGEMENT OF COMPLEX INFRASTRUCTURE: INFORMATION SYSTEMS IN THE AGE OF BIG DATA Timo Hartmann .....	21
--	----

## 1 TRAFFIC PLANNING AND MODELLING

OPENTRACK – A TOOL FOR SIMULATION OF RAILWAY NETWORKS Hrvoje Haramina, Andreas Schöbel, Jelena Aksentijević .....	39
CRITERIA FOR URBAN TRAFFIC INFRASTRUCTURE ANALYSES – CASE STUDY OF IMPLEMENTATION OF CROATIAN GUIDELINES FOR ROUNDABOUTS ON STATE ROADS Mateo Kozic, Sanja Šurdonja, Aleksandra Deluka-Tibljaš, Barbara Karleuša, Marijana Cuculić .....	45
MODELLING TRAVEL BEHAVIOR OF RAILWAY PASSENGERS UNDER TRAVEL TIME UNCERTAINTY Kazuyuki Takada, Kota Miyauchi .....	53
EVALUATION OF THE CALIBRATED MICROSIMULATION TRAFFIC MODEL BY USING QUEUE PARAMETERS Irena Ištoka Otković, Matjaž Šraml .....	59
NEW INDICATORS FOR NEW INFRASTRUCTURE Harald Frey, Anna Mayerthaler, Ulrich Leth .....	67
THE NATIONAL TRANSPORT MODEL FOR THE REPUBLIC OF CROATIA – APPLICATION AND USE Uwe Reiter, Igor Majstorović, Ana Olmeda Clemares, Gregor Pretnar .....	73
THE NATIONAL TRANSPORT MODEL FOR THE REPUBLIC OF CROATIA – DEVELOPMENT OF THE FREIGHT DEMAND MODEL Jens Landmann, Andree Thomas, Igor Majstorović, Gregor Pretnar .....	83
THE NATIONAL TRANSPORT MODEL FOR THE REPUBLIC OF CROATIA – DEVELOPMENT OF THE PASSENGER DEMAND MODEL Gregor Pretnar, David Trošt, Igor Majstorović, Jens Landmann, Andree Thomas .....	91
INITIATIVE FOR DEVELOPMENT OF SUSTAINABLE MULTIMODAL TRANSPORT AND MOBILITY NETWORK IN THE ADRIATIC-IONIAN REGION Saša Džumhur, Enes Čovrk .....	101
THE EFFECTS OF FORECASTS ON THE LEVEL OF MOTORIZATION – A SELF-FULFILLING PROPHECY? Anna Mayerthaler, Harald Frey, Ulrich Leth .....	109
ANALYSIS OF HEADWAY CHARACTERISTICS IN DISSIPATING QUEUES András Szele, Árpád Barsi, Lajos Kisgyörgy .....	115
HYBRID ALGORITHM FOR TICKET RESERVATION PROCESS IN PASSENGER RAIL TRANSPORT Dragana Macura, Milica Selmić, Dušan Teodorović, Milutin Milošević .....	123
FUNCTIONAL CONNECTING OF THE RAILWAY BYPASS AROUND NIŠ AND THE RAILWAY JUNCTION NIŠ Tatjana Mikić, Dragan Djordjević .....	131
INTELLIGENT INFRASTRUCTURE AND ITS USE IN MONITORING AND REGULATION OF ROAD TRAFFIC Abidin Deljanin, Fadila Kiso, Emir Deljanin .....	141
COMPARISON OF SOME CAPACITY AND CONTROL DELAY MODELS ON ROUNDABOUTS Ivan Lovrić, Sanjin Albinović, Ammar Šarić, Danijela Maslač .....	149

## 2 ROAD PAVEMENT

STUDY OF COMPACTABILITY MODELS DESCRIBING ASPHALT SPECIMEN COMPACTION WITH GYRATORY AND WITH IMPACT COMPACTOR Marjan Tušar,3, Miha Šlibar, Aleksander Ipavec, Mojca Ravnikar Turk .....	157
THE BEST PRACTISE OF THE OF RECYCLED TYRE RUBBER MODIFIED ASPHALT BINDERS AND MIXES Ovidijus Šernas, Donatas Čygas, Audrius Vaitkus .....	165
MECHANISTIC ASPHALT OVERLAY DESIGN METHOD FOR HEAVY DUTY PAVEMENTS Zoltán Soós, Zsuzsanna Igazvölgyi, Csaba Tóth, László Pethő .....	173
ACTUAL EFFICIENCY OF ROAD PAVEMENT REHABILITATION László Gáspár .....	181
IN-SITU ASSESSMENT OF LOW NOISE ASPHALT PAVEMENTS ACOUSTICAL PERFORMANCE Audrius Vaitkus, Viktoras Vorobjovas, Tadas Andriejauskas .....	187
EFFECTIVENESS OF THE STEEL MESH TRACK IN STRENGTHENING CRACKED ASPHALT PAVEMENTS Piotr Zieliński, Wanda Grzybowska .....	195
POROSITY EFFECT ON PHYSICAL AND MECHANICAL PROPERTIES OF PERVIOUS CONCRETE PAVEMENT Miloš Šešlija, Vlastimir Radonjanin, Nebojša Radović, Đorđe Ladinović .....	203
ANALYSIS OF SOLUTIONS FOR SUPERELEVATION DESIGN FROM THE STANDPOINT OF EFFICIENT DRAINAGE Martina Zagvozda, Željko Korlaet .....	209
EFFECT OF TYPE OF MODIFIED BITUMEN ON SELECTED PROPERTIES OF STONE MASTIC ASPHALT MIXTURES Marta Wasilewska, Krzysztof Blazejowski, Przemyslaw Pecak .....	217
IMPACT ASSESSMENT IN THE PAVEMENT LIFE CYCLE DUE TO THE OVERWEIGHT IN THE AXLE LOAD OF COMMERCIAL VEHICLES Lúcia Pessoa De Oliveira, Cassio Lima De Paiva, Adelino Ferreira .....	223
QUALITY ASSURANCE OF ASPHALT PAVEMENT Denisa Cihlářová, Petr Mondschein .....	229
EFFECT OF MOISTURE CONTENT AND FREEZE-THAW CYCLES ON BEARING CAPACITY OF RAP/ NATURAL AGGREGATE MIXTURES Josipa Domitrović, Tatjana Rukavina, Sanja Dimter .....	237
IMPACT OF WASTE ENGINE OIL AS REJUVENATOR ON UTILIZATION OF RECLAIMED ASPHALT PAVEMENT IN BITUMINOUS MIXTURES Peyman Aghazadeh Dokandari, Derya Kaya, Ali Topal, Burak Şengöz, Jülide Öner .....	245
EVALUATION OF CHEMICAL FRACTIONS IN PAVING GRADE BITUMEN 50/70 AND EFFECTS ON RHEOLOGICAL PROPERTIES Diana Simnofske, Konrad Mollenhauer .....	259
ROLLED COMPACTED CONCRETE PAVEMENTS László Énekes, Zsolt Bencze, László Gáspár .....	267
<b>3 TRANSPORT GEOTECHNICS</b>	
QUANTITATIVE LANDSLIDE SUSCEPTIBILITY AND HAZARD ANALYSIS FOR EARTHWORKS ON TRANSPORT NETWORKS Karlo Martinović,2, Kenneth Gavin,3, Cormac Reale .....	277
MULTI-MODAL RISK ASSESSMENT OF SLOPES Cormac Reale, Kenneth Gavin, Karlo Martinović .....	285
REMEDICATION OF KARST PHENOMENA ALONG THE CROATIAN HIGHWAYS Mario Bačić, Bojan Vivoda, Meho Saša Kovačević .....	293
VOLUME MEASUREMENTS OF ROCKFALLS USING UNMANNED AERIAL VEHICLES Marijan Car, Danijela Jurić Kačunić, Lovorka Librić .....	301
MONITORING OF INFLOW GROUNDWATER INTO SUBWAY STATION IN SOUTH KOREA Bo-Kyong Kim, Young-Kon Park, Sung-Jin Lee, Jin-Wook Lee, Sun-Il Kim, Seong-Chun Jun .....	309

## 4 TRACTION VEHICLES

<b>EFFICIENT RAILWAY INTERIORS – EXPERIENCES</b> Bernhard Rüger.....	319
<b>PROBLEMS OF IDENTIFYING CONDUCTED DISTURBANCES IN A CURRENT DRAWN FROM A 3 kV DC CATENARY BY VEHICLES EQUIPPED WITH POWER CONVERTERS</b> Marcin Steczek, Adam Szela.....	327
<b>PRACTICAL EXPERIENCE AND IN-SERVICE VEHICLE DYNAMICS MEASUREMENTS BASED MAINTENANCE STRATEGY FOR TRAMWAYS INFRASTRUCTURE</b> Ákos Vinkó, Péter Bocz.....	335
<b>POWER CONTROL ALGORITHM OF HYBRID ENERGY STORAGE SYSTEM FOR VEHICULAR APPLICATIONS</b> Maciej Wieczorek, Mirosław Lewandowski.....	343

## 5 URBAN TRANSPORT

<b>ROUTE GUIDANCE OF TRAM TRAFFIC IN CITIES: PARTICULARITIES OF TRAM TRAFFIC IN THE CITY OF OSIJEK</b> Martina Zagvozda, Sanja Dimter, Filip Ruška.....	353
<b>THE EVOLUTION OF URBAN TRANSPORT – UBER</b> Marko Slavulj, Krešimir Kanižaj, Siniša Đurđević.....	359
<b>STUDY ON USAGE BEHAVIOUR OF THE ARTERIAL TRAFFIC IN JAPAN</b> Kosuke Koike, Makoto Fujju, Shoichiro Nakayama, Jun-Ichi Takayama.....	365
<b>SUSTAINABLE URBAN MOBILITY PLANS</b> Davor Brčić, Marko Šoštarić, Dino Šojat.....	373
<b>DID CYCLING POLICY AND PROGRAMS ADVANCE CYCLING IN THE CITY OF ZAGREB?</b> Hrvoje Pilko, Tadej Brežina, Krunoslav Tepeš.....	379

## 6 TUNNELS & BRIDGES

<b>THE LONG-TERM BRIDGE PERFORMANCE (LTBP) PROGRAM BRIDGE PORTAL</b> Hooman Parvardeh, Saeed Babanajad, Hamid Ghasemi, Ali Maher, Nenad Gucunski, Robert Zobel.....	389
<b>USE OF AIR-COUPLED SENSING IN THE ASSESSMENT OF BRIDGE DECK DELAMINATION AND CRACKING</b> Nenad Gucunski, Seong-Hoon Kee, Basily Basily, Jinyoung Kim, Ali Maher.....	397
<b>INTERACTION BETWEEN CONTINUOUS WELDED RAIL AND BRIDGES WITH RELATIVELY LARGE EXPANSION LENGTH</b> Otto Plášek, Otakar Švábenský, Hana Krejčířířková, Ladislav Klusáček, Jiří Vendel.....	405
<b>ANALYSIS OF THE INFLUENCE OF THE NATURAL ENVIRONMENT ON BRIDGE SOUNDNESS</b> Takahiro Minami, Makoto Fujju, Shoichiro Nakayama, Junichi Takayama.....	413
<b>RECONSTRUCTION OF THE RAILWAY TUNNELS TIČEVO, KLOŠTAR AND RESNJAK</b> Snježana Špehar.....	421

## 7 INTEGRATED TIMETABLES ON RAILWAYS

<b>CHALLENGES FOR AN INTEGRATED TIMETABLE IN AUSTRIA</b> Hans Wehr, Andreas Schöbel.....	431
<b>SOLVING A BOTTLENECK ON A STRATEGIC POINT OF THE HUNGARIAN RAILWAY NETWORK</b> Viktor Borza, János Földiák.....	437

## 8 INFRASTRUCTURE PROJECTS

<b>ONE MODEL FOR RAIL PROJECTS EVALUATION WITH INTERVAL-VALUED FUZZY NUMBERS</b> Dragana Macura, Marko Kapetanovic, Nebojsa Bojovic, Milutin Milosevic.....	447
<b>INVESTMENTS IN INFRASTRUCTURE THROUGH PPP IN SPAIN – PAST ACHIEVEMENTS AND CURRENT TRENDS</b> Alejandro Lopez Martínez, Cesar Queiroz.....	455

ENTRANCE TERMINAL OF THE PORT OF PLOCE – ENDPOINT OF THE VC CORRIDOR Boris Vidak .....	463
MODEL TEST TO DETERMINE LOAD-SETTLEMENT CHARACTERISTICS ON SOFT CLAY USING PILE-RAFT SYSTEM M. V. Shah, Devendra V. Jakhodiya, A. R. Gandhi .....	471
OPERATIONAL PLAN FOR CONSTRUCTION OF RAILWAY LINE BELGRADE – NIŠ ON SECTION STALAC – ĐUNIS Tatjana Simić, Tatjana Mikić, Tomislav Miličević .....	479
TRANSPORT NETWORK DEVELOPMENT IN SOUTH-EAST EUROPE Oliver Kumrić, Domagoj Šimunović, Goran Puž .....	489
ANALYSIS OF POSSIBILITIES TO INCREASE THE CAPACITY OF M202 ZAGREB-RIJEKA RAILWAY LINE ON SECTION OGULIN-ŠKRLJEVO Maja Ahac, Stjepan Lakušić, Ivan Obad, Katarina Vranešić .....	497
THE EFFECTS OF GENERAL OVERHAUL RAILROAD IN FB&H Mirna Hebib-Albinović, Sanjin Albinović, Ammar Šarić .....	507
RECONSTRUCTION AND MODERNIZATION OF RAILWAY SUBOTICA (FREIGHT) – HORGOS – SERBIAN-HUNGARIAN BORDER Ljiljana Milić Marković, Ljubo Marković, Goran Čirović .....	513
THE SPECIFICITY OF TECHNICAL CONSTRUCTIONS REGIMES INSIDE TERMINALS AND LOGISTICS CENTRES Krzysztof Gradkowski .....	521
CROATIAN AIRFIELDS – POTENTIAL FOR AVIATION TOURISM DEVELOPMENT Ivana Barišić, Gordana Prutki-Pečnik, Goran Ratkajec, Roman Cvek .....	527
LEVEES CONDITION ASSESSMENT IN CROATIA Katarina Ravnjak, Goran Grget, Meho Saša Kovačević .....	535
NEW RAILWAYS IN THE TRIESTE-KOPER AREA Marko Jelenc, Andrej Jan .....	543
USE OF SPIRAL STEEL PIPES DURING CONSTRUCTION OF SOUTHERN BYPASS FOR DONJI MIHOLJAC Hrvoje Pandžić, Adam Czerepak, Mario Bogdan .....	549
ESTABLISHING THE CAPACITIES IN THE INNER CITY – SUBURBAN RAIL PASSENGER TRANSPORT Branimir Duvnjak, Tomislav Josip Mlinarić, Renato Humić .....	557
GREEN FUTURE FOR NARROW GAUGE RAILWAYS – VISION AND REALITY IN HUNGARY Csaba Orosz, Dóra Bachmann .....	567
EXAMPLES OF FLEXIBLE FOUNDATIONS OF SOIL-STEEL STRUCTURES MADE OF CORRUGATED SHEETS Czesław Machelski, Adam Czerepak, Mario Bogdan .....	573
<b>9 INFRASTRUCTURE MANAGEMENT</b>	
ENHANCING RAILWAY INFRASTRUCTURE ASSETS AGAINST NATURAL HAZARDS Jelena Aksentijevic, Andreas Schöbel, Christine Schönberger .....	583
ECODRIVING POTENTIALITY ASSESSMENT OF ROAD INFRASTRUCTURES ACCORDING TO THE ADEQUACY BETWEEN INFRASTRUCTURE SLOPES AND SPEEDS LIMITS Alex Coiret, Pierre-Olivier Vandanjon, Ana Cuervo-Tuero .....	589
EVALUATION OF INFRASTRUCTURE CONDITIONS BY 3D MODEL USING DRONE Hiroyuki Miyake, Makoto Fujii, Shoichiro Nkayama, Jyunichi Takayama .....	597
A LOCAL AUTHORITY’S RISK-BASED APPROACH TO PRINCIPAL INSPECTION FREQUENCY OF STRUCTURES Gary McGregor, Slobodan B. Mickovski .....	603
APPLICATION OF SENSITIVITY ANALYSIS FOR INVESTMENT DECISION IN BUILDING OF UNDERGROUND GARAGE Suada Džebo .....	611
HOW TO EFFECTIVELY IMPLEMENT MOBILITY MANAGEMENT FOR COMPANIES – EXPERIENCES AND EXAMPLES FROM 5 YEARS OF “SÜDHESSEN EFFIZIENT MOBIL” André Bruns .....	619

<b>DEVELOPING DECISION SUPPORT TOOLS FOR RAIL INFRASTRUCTURE MANAGERS</b> Irina Stipanovic Oslakovic, Kenneth Gavin, Meho Saša Kovačević.....	627
<b>SOME ISSUES REGARDING THE LEGAL STATUS OF ROADS IN THE REBULIC OF CROATIA</b> Damir Kontrec, Davor Rajčić.....	635
<b>10 CONSTRUCTION &amp; MAINTENANCE</b>	
<b>BITUMEN SELECTION APPROACH ASSESSING ITS RESISTANCE TO LOW TEMPERATURE CRACKING</b> Judita Gražulytė, Audrius Vaitkus, Igoris Kravcovas.....	643
<b>HOLISTIC APPROACH TO TRACK CONDITION DATA COLLECTION AND ANALYSIS</b> Janusz Madejski.....	651
<b>RELATIONSHIP BETWEEN LIFESPAN AND MECHANICAL PERFORMANCE OF RAILWAY BALLAST AGGREGATE</b> Vaidas Ramūnas, Audrius Vaitkus, Alfredas Laurinavičius, Donatas Čygas.....	659
<b>POSSIBILITIES OF ENERGY SAVINGS IN HOT-MIX ASPHALT PRODUCTION</b> Zdravko Cimbola, Zlata Dolaček-Alduk, Sanja Dimter.....	667
<b>MAIN WORKS FOR CONSTRUCTION OF RAILWAY BYPASS AROUND NIŠ</b> Tatjana Simić.....	675
<b>11 RAIL TRACK STRUCTURE</b>	
<b>TRACK MAINTENANCE AT THE END OF LIFE CYCLE</b> Waldemar Alduk, Saša Marenjak.....	687
<b>ANALYSIS OF NEW SUPERSTRUCTURE COMPONENTS OF RAILWAY</b> <b>TRACK IN TUNNEL SOZINA IN MONTENEGRO</b> Zoran Krakutovski, Darko Moslavac, Zlatko Zafirovski, Aleksandar Glavinov.....	695
<b>STABILITY CHART FOR CAVITY EXISTENCE BELOW RAILWAY TRACK</b> Yujin Lim, JinWook Lee, Hojin Lee, Sang Hyun Lee.....	703
<b>PROPOSAL FOR THE WHEEL PROFILE OF THE NEW TRAM-TRAIN VEHICLE IN HUNGARY</b> Péter Bocz, Ákos Vinkó.....	709
<b>FLOW ON THE BALLASTED TRACKBED WITH PERMEABLE SURFACES</b> <b>AND ITS INFLUENCE ON THE BALLAST FLIGHT</b> Jianyue Zhu, Zhiwei Hu.....	715
<b>CONCRETE MIX DESIGN FOR THE REMEDY OF CORRODED CONCRETE SLEEPERS</b> Fitim Shala, Muhammad Umair Shaukat.....	723
<b>VERIFICATION AND OPTIMIZATION OF TRANSITION AREAS OF</b> <b>BALLASTLESS TRACK IN THE TUNNEL TURECKÝ VRCH</b> Libor Ižvolt, Michal Šmalo.....	733
<b>ANALYSIS OF THE CRANE RAIL TRACKS OF BULK CARGO TERMINAL AT THE PORT OF PLOČE</b> Stjepan Lakušić, Darko Badovinac, Viktorija Grgić.....	741
<b>BALLASTLESS TRACK SYSTEMS ROAD TO RAIL SYNERGIES FOR BETTER TRANSPORT INFRASTRUCTURE</b> Bernhard Lechner.....	751
<b>RECONSTRUCTION OF THE RAILWAY STATIONS SLAVONSKI BROD AND VINKOVCI</b> Snježana Špehar.....	757
<b>12 NOISE &amp; VIBRATION</b>	
<b>VIBRATION-NOISE-CANCELLING ASPHALT PAVEMENT: INNOVATION FOR SILENT CITIES</b> Loretta Venturini, Sergio Carrara.....	769
<b>ENVIRONMENTAL IMPACT OF TRAFFIC NOISE</b> Riste Ristov, Slobodan Ognjenović, Ivana Nedevska.....	785
<b>MONITORING OF DYNAMIC PROPERTIES OF NEW TYPE OF TRAM</b> <b>TRACK FASTENING SYSTEMS UNDER TRAFFIC LOAD</b> Ivo Haladin, Stjepan Lakušić, Janko Koščak, Marko Bartolac.....	791

## 13 INNOVATION & NEW TECHNOLOGY

<b>A MULTI-OBJECTIVE OPTIMIZATION-BASED PAVEMENT MANAGEMENT DECISION-SUPPORT SYSTEM FOR ENHANCING PAVEMENT SUSTAINABILITY</b> João Santos, Adelino Ferreira, Gerardo Flinstch .....	803
<b>ENERGY HARVESTING ON TRANSPORT INFRASTRUCTURES: THE SPECIFIC CASE OF RAILWAYS</b> Francisco Duarte, Adelino Ferreira, Cássio Paiva .....	811
<b>EXPLOITATION OF NEW TECHNOLOGIES FOR COLLECTION AND PROCESSING OF MOTORWAY TRAFFIC DATA</b> Antoniadis Christos, Sotiriadou Styliani, Papaioannou P. ....	817
<b>EFFICIENT RAILWAY INTERIORS – EXPERIENCES BAGGAGELESS – BAGGAGE LOGISTIC SYSTEM</b> Bernhard Rüger, Petra Matzenberger, Volker Benz .....	823
<b>PROTOTYPE RAILWAY WAGON WITH ROTATABLE LOADING PLATFORM AND CONCEPT OF INNOVATIVE INTERMODAL SYSTEM USAGE</b> Tadeusz Niezgoda, Wieslaw Krason .....	831
<b>IMPACT OF THE ENVIRONMENT OF AN ORGANISATION ON ITS CAPACITY FOR THE DIFFUSION OF INNOVATIONS: ITT APPLICATION AND BIM ADOPTION</b> Sanjana Buć, Miroslav Šimun .....	839
<b>COMPARISON OF DIFFERENT SURVEY METHODS DATA ACCURACY FOR ROAD DESIGN AND CONSTRUCTION</b> Vladimir Moser, Ivana Barišić, Damir Rajle, Sanja Dimter .....	847
<b>14 TRAFFIC SAFETY</b>	
<b>OPERATING SPEED MODELS ON TANGENT SECTIONS OF TWO-LANE RURAL ROADS</b> Dražen Cvitanić, Biljana Maljković .....	855
<b>SAFETY AT LEVEL CROSSINGS: COMPARATIVE ANALYSIS</b> Martin Starčević, Danijela Barić, Hrvoje Pilko .....	861
<b>PROBLEMS OF CROSSFALL CHANGEOVER FOR REVERSED CROSSFALLS</b> Ivan Lovrić, Boris Čutura, Danijela Maslač .....	869
<b>EFFECTIVE AND COORDINATED ROAD INFRASTRUCTURE SAFETY OPERATIONS: COMMON PROCEDURES FOR JOINT OPERATIONS AT ROADS AND TUNNELS</b> Marios Miltiadou, Liljana Cela, Mate Gjorgjievski .....	877
<b>REVIEW OF FASTEST PATH PROCEDURES FOR SINGLE-LANE ROUNDABOUTS</b> Saša Ahac, Tamara Džambas, Vesna Dragčević .....	885
<b>GEOMETRIC DESIGN OF TURBO ROUNDABOUTS ACCORDING TO CROATIAN AND DUTCH GUIDELINES</b> Tamara Džambas, Saša Ahac, Vesna Dragčević .....	893
<b>SWEPT PATH ANALYSIS ON ROUNDABOUTS FOR THREE-AXLE BUSES – REVIEW OF THE CROATIAN DESIGN GUIDELINES</b> Šime Bezina, Ivica Stančerić, Saša Ahac .....	901
<b>THE EVALUATION OF BICYCLE PATHS ON BRIDGES</b> Hwachyi Wang,2, Hans De Backer, Dirk Lauwers, S.K. Jason Chang .....	909
<b>ANALYSIS OF SIGHT DISTANCE AT AN AT-GRADE INTERSECTION</b> Ivana Pranjić, Aleksandra Deluka-Tibljaš, Dražen Cvitanić, Sanja Šurdonja .....	921
<b>INCREASING ROAD SAFETY BY IMPROVING ILLUMINATION OF ROAD INFRASTRUCTURE</b> Flavius-Florin Pavăl .....	929
<b>TRAFFIC SAFETY ASSESSMENT MODEL METHOD – SSAM</b> Gregor Kralj, Marko Jelenc .....	935

## 15 COMPUTER TECHNIQUES & SIMULATIONS

### SELECTED ASPECTS OF NUMERICAL AND EXPERIMENTAL STUDIES OF PROTOTYPE RAILWAY WAGON FOR INTERMODAL TRANSPORT

Wiesław Krason, Tadeusz Niezgoda, Michał Stankiewicz ..... 943

### DEVELOPMENT OF SPECIALIZED FORCE SENSOR FOR RAILWAY WAYSIDE MONITORING SYSTEMS

Nencho Nenov, Emil Dimitrov, Petio Piskulev, Nikolay Dodev..... 951

### UNDERSTANDING AND PREDICTING GLOBAL BUCKLING DURING CONSTRUCTION OF STEEL BRIDGES

Steve Rhodes, Philip Icke, Paul Lyons ..... 959

## 16 POWER SUPPLY OF TRANSPORT SYSTEMS

### PROBLEMS OF ELECTRICAL SAFETY IN DEPOTS AND WORKSHOPS FOR SERVICING ELECTRIC TRACTION VEHICLES

Tadeusz Maciołek, Adam Szeląg..... 969

### TIMETABLE OPTIMIZATION ON THE RAILWAY LINE ELECTRIFIED IN A DC POWER SYSTEM IN TERMS OF ENERGY CONSUMPTION USING THE PARTICLE SWARM OPTIMIZATION

Włodzimierz Jefimowski..... 977

## 17 STRUCTURAL MONITORING

### STATIC AND DYNAMIC TESTING OF STEEL RAILWAY BRIDGE “SAVA”

Domagoj Damjanović, Janko Koščak, Ivan Duvnjak, Marko Bartolac ..... 989

### THE INTERACTION OF STEEL RAILWAY BRIDGES WITH WOODEN SLEEPERS AND LOADED CWR TRACKS IN RESPECT OF LONGITUDINAL FORCES

Helga Papp, Nándor Liegner..... 997

AUTHOR INDEX ..... 1003





## KEYNOTE LECTURE





## VIRTUAL MANAGEMENT OF COMPLEX INFRASTRUCTURE: INFORMATION SYSTEMS IN THE AGE OF BIG DATA

**Timo Hartmann**

*TU Berlin, Civil Engineering Institute, Systems Engineering Chair*

### Abstract

Currently a fundamental shift in how infrastructure managers and engineers obtain and make use of virtual information is taking place. In recent years, vast amount of information has become available in distributed virtual systems, be it publicly available or within the information infrastructure of a single organization, which is often labelled as BIG DATA. The availability of BIG DATA makes it now possible that information that is required for many decisions is somewhere available, but needs to be meaningfully mined, fused, and visualized. While only some years ago, much work of infrastructure managers and engineers was concerned with specifying the information to make a decision that then was carefully collected by inspecting and measuring, nowadays, most decision making tasks start with a broad search of virtual information that is already somewhere available. Obtaining and making use of information in this new style of working has become much more dynamic and unpredictable, but at the same time much quicker and richer. This paper shows a range of examples from our ongoing research activities from the area of managing road and rail infrastructure systems that shows the potential of this new way of working. Based on these examples, the paper then discusses some of the implication this new way of working has for setting up information management strategies at large organizations, such as engineering companies and public authorities. In particular, the paper argues that modern information management systems need to be open, agile, and distributed to fully support the newly emerging practices.

### 1 Introduction

Access to information has always been a crucial aspect of infrastructure engineering work, be it during the design and construction of new infrastructure or during the maintenance of existing infrastructure systems. Large parts of engineering work is then also concerned with obtaining information ranging from social aspects, such as traveling behaviour or preferences of abutters, to engineering aspects, such as material strengths or specification of parts, to physical aspects of the surrounding, such as the existing soil conditions or weather data. In traditional practice, engineers carefully considered information requirements upfront for which they then data was carefully collected by inspectors and surveyors before engineering or planning decision making activities started.

Recently, this traditional practice is changing. This change is caused by more and more data sets about existing natural and physical conditions, but also about the behaviour of infrastructure users are becoming available. Examples for such data sets are, for example, Google maps [1] or Open Street Maps [2] that make information available about the existing infrastructure networks in most countries, Google Street View [3] providing photographic imagery, the Dutch AHN (actueel hoogtebestand) [4] that provides detailed 3D points of the entire Netherlands, or different initiatives of European communities to share data about infrastructure [5], such as the city of Enschede's open GIS data repository, or the city of Berlin's or Seattle's 3D Cesium models [6].

Next to these trends in open data, many public and private organizations are starting to collect large amounts of data. These data are often collected without a specific goal or decision in mind. Examples for this new emerging practice are the efforts of many organizations to collect laser scan data of their existing structures, the equipment of bridges and tunnels with sensors and monitoring systems, or the equipment of construction machinery with GPS and other tracking devices.

All these efforts have change engineering practice in the last years significantly. Engineers traditionally started new design efforts with drafting a data collection plan, then collecting these data, and only then starting to design. Today, engineers, more and more, start designing much earlier using existing data and only collect additional data, if some information is not available. The most illustrative example for this practice is probably the many engineering efforts that start on maps printed out of Google Maps.

A close look at these emerging practices shows that engineering work is becoming much more interactive, agile, and iterative. This in particular holds for the application of supporting tools within this practice. To make full avail of the available data by combining different sources and formats, engineers start to develop many customized data fusion and visualization methods. Many of the existing proprietary software programs and database systems do not support this practice well. The missing support, in turn, challenges many of the, at private and public organizations existing, IT systems and IT implementation strategies.

This paper provides a number of examples of data fusion and visualization methods from railway and roadway engineering. All examples show how data from different sources were combined to support decision making and design. Based on these examples the paper will discuss how existing IT systems and IT system implementation strategies need to change to support such combination of data from different sources. The paper is structured as follows: The next section will provide a brief introduction about data fusion and BIG DATA as it applies to infrastructure design and planning. Afterward the paper will provide a number of data fusion examples from road and railway design. After these examples we will provide our argument of how current IT system and implementation needs to change to allow for benefiting from the vast amount of data that is becoming available.

## 2 BIG DATA driven simulation and visualization systems

To support their design work engineering and planners make use of simulation and visualization models. These models abstract and formalize knowledge about the characteristics of a specific physical situation and a number of social, technical, or natural processes within that situation [7, 8]. For example, spatial models abstract an urban area using a geographical information model and different behavioural processes of humans that live in the area. Another example are finite element models of bridges that abstract the structural behaviour of the bridge. Through abstraction simulation and visualization models allow designer to experiment with perceived future conditions by changing certain parameters of the physical situation, in the examples above some geographical or structural characteristics that reflect certain transformation possibilities. This allows designers to explore alternatives for designing and planning inquiries that are too complex to be meaningfully represented by physical prototypes or mathematical models.

If simulation and visualization models provide adequate abstractions of the existing natural, technical, and social conditions, models become a none-replaceable part of all engineering and planning decision making work throughout the entire life-cycle of an infrastructure system. This potential has been discussed by many. Research for example has shown that data driven simulation and visualization models can bridge knowledge boundaries between different specialists [9, 10] or enabling multi-disciplinary design teams to generate new knowledge in the form of creative design ideas [11,12].

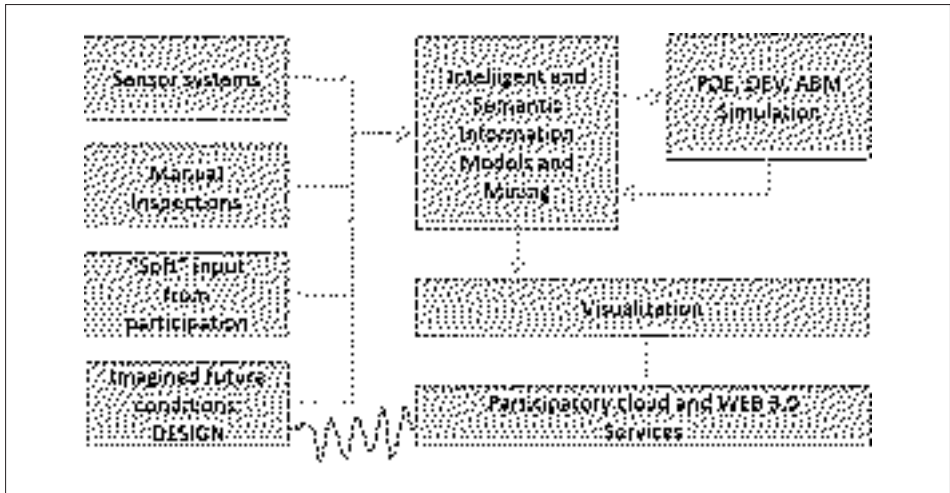


Figure 1 Basic architecture of a decision support system

Figure 1 depicts the core architecture of such data driven simulation and visualization systems. They all rely on input from a variety of different data sources. As design and planning work for infrastructure systems always need to account for the status quo, much of these sources are related to information about the existing natural, physical, and social conditions around an infrastructure network. Traditionally, large parts of the data input describing the existing conditions relied on manual inspections and surveying exercises.

With the fast improvement of sensing technology much of the labor intensive manual inspection work is slowly replaced by sensor systems. The use of sensor systems can replace much of the labor intensive field work. At the same time, however, the adequate use of sensors still requires thorough upfront planning. Additionally, cleaning and analyzing sensor data is still very labor intensive.

Additionally to data about the existing conditions, soft data about the requirements, wishes, and constraints of stakeholders involved around a design or planning effort become increasingly important. This data is often less standardized, but as important as input to design and planning efforts as data about the existing conditions. After all, the re-designed infrastructure network's purpose is to support the social and economic needs of citizens.

A final important source of data are the different design ideas. As planning and design relies on input from many different specialists, every design and planning effort always involves vast amounts of data representing these different inputs. Additionally, planning and design is also an iterative process. Data representing design ideas ideally therefore captures different concurring possibilities describing different alternatives for future actions. Obviously, capturing different alternatives increases the amount of data significantly.

To allow for meaningful decision making around these different types of data, information models are required that allow to meaningful convert the raw data into meaningful information. To this end, information models provide a computer based representation of data in the form of objects that allow humans, as well as, computers to reason about the data. For example, the physical characteristics of structures can be represented by using parametric object building information models that describe structures as building elements, such as beams, columns, or walls. Additional information can then be attached to these elements. Some well-known building information schema are the Industry Foundation Classes (IFC) ISO standard or the CityGML standard. Moreover, most 3D based parametric CAD systems use their own representation schema.

Another example are geo-spatial data that most of the existing GIS applications represent using polygons. Again different information ranging from the demographics of a specific area to natural and geographic characteristics of an area can be attached to the basic polygonal object representing a specific area. Next to these geometrical ways to represent data meaningfully with the computer, many other possibilities exist, ranging as wide as meaningfully named SQL tables or NoSQL based document storage.

Oftentimes, the transformation of raw input data into meaningful information models is not easy. Manual conversion is often error prone and time consuming. Therefore, much recent research and development work has focused on the development of advanced data mining methods applying state of the art machine learning methods. These methods automate the cumbersome work of categorizing input data of different formats, such as from images, point clouds, or historical databases. Next to machine learning methods, the conversion of raw data into meaningful information models also relies on data fusion mechanisms that allow to combine raw data from different sources.

Once data is meaningfully represented using semantic information models, computer applications can be developed that use the data to meaningfully simulate possible scenarios of future conditions. Often used simulation methods in the area of infrastructure design and planning are methods based on partial differential equations, discrete event simulations, or agent based simulations. What all of these methods have in common is that they take data meaningfully represented through information models as input. Then the data is used to simulate a number of possible future alternatives. The outcomes of these simulations, in turn, come in the form of additional data. If different alternatives and scenarios are simulated, the amount of these data is often larger than the initial input data. Again, these output data need to be meaningfully converted and stored in semantic information models to allow computers and humans to reason with the simulation output.

To support meaningful decisions all data, be it data about existing conditions or simulation output, have to be represented to decision makers. To this end, purposeful data visualizations need to be generated. This generation again requires the fusion and mining of the existing data with the help of meaningful semantic information models.

To close the cycle, designers and planners then make decisions about the future configuration of an infrastructure network, about maintenance cycles, and so forth. Again these decision are oftentimes modeled and can serve as data input for the next decision cycle.

In summary, the meaningful introduction of simulation and visualization models in engineering design processes requires a tight integration with large amounts of data representing a wide range of different aspects. Because design by definition involves the creation of something new, it is important for simulation and visualization models to provide an accurate model of the existing physical situation for a meaningful departure from this status quo. Modeling this existing condition, in turn, requires accurate input data that can stem from a large variety of different sources, ranging from existing drawings and documents, to manual collection, to sensor based measurements using, for example, laser scanners or photogrammetric methods. At the same time, these data have to be meaningfully combined with computer based representations of design requirements and suggested future design alternatives. To illustrate this practice, the following section introduces four examples of such data driven decision support systems from the domains of road and railway design and planning.



### 3 The cases

Without going into detail the paper will provide brief descriptions of four cases of previous or ongoing research work. More detail about each of the cases can be found, with the exception of the second case, in more detailed journal publications. I would like to refer the interested reader to these publications to learn more about the specific system implementations of each of the cases. The four cases are:

- 1) An illustration of how to support construction activities for railway stations. This case shows how different input data are fused to coordinate different design and construction tasks on two major European train stations: Amsterdam Centraal and Arnhem Centraal [13]
- 2) The second example from railway planning and design was concerned with using the existing data at a major European railway organization to use machine learning techniques to predict delay propagation based on historical schedule data.
- 3) The project to illustrate the possibilities to support road construction activities was conducted within the context of an asphalt paving living lab. The simulation and visualization system developed was concerned with tracking and controlling asphalt paving operations in real time to ensure continuous process improvements and long term quality of the constructed road [14, 15, 16].
- 4) An example to illustrate long term planning efforts for road network management was conducted within a study to explore the possibilities of machine learning methods to understand deterioration of roads based on design parameters and environmental conditions [17, 18].

#### 3.1 Refurbishment design and construction planning of train stations

The inner city traffic infrastructure is crumbling. In the European context this is particular visible at the existing major train stations. To overcome the problem with the existing Dutch stations the Dutch government has started a program to renovate its major train stations for example in Amsterdam, Delft, Arnhem, or Rotterdam. One major issue during the renovation and upgrade of train stations is that new design ideas need to be integrated with old existing structures and architecture. Engineering the integration of such new ideas is often one of the most time consuming processes during the overall planning, engineering, and construction process. However, the required coordination work can be significantly improved by decision support systems that allow to clearly understand how new proposed renovation measures will fit with the existing conditions.

In the case of the Amsterdam railway station renovation it was therefore decided to obtain a laser scan of the existing conditions. It was then planned to match the scan with the new proposed design of all architects and engineers that were involved on the project. The laser scans provided a large amount of data that had to be integrated meaningful in the engineering process. To this end, the project team developed a specific system. The basis for the system was an accurate Building Information Model (BIM) that was established based on the data from the laser scans. This BIM model transformed the semantically poor description of the existing condition from the laser scans – laser scans simply provide a so called point cloud that describe existing geometry in the form of a large number of three dimensional points – into an accurate semantic description of the existing train station. This semantic description, for example, provided information about the type of objects, e.g. column, ceiling, wall, about the object's material and its function. All this information was essential to support the engineering process on this project.

This as-built BIM was then used in two different ways to support the engineering process of the project. For one, the model provided the engineers with an accurate description of the existing situation that they could use to develop creative ideas for how to best engineer the transformation of the train station. Additionally, after specific alternative solutions had been

engineered, these solutions could automatically be compared with the existing situation. In this manner, the engineers on the project were able to identify a number of conflicts between the existing conditions and their envisioned future condition that would have probably required costly adjustments of the design during the later construction phase, Figures 2 and 3.

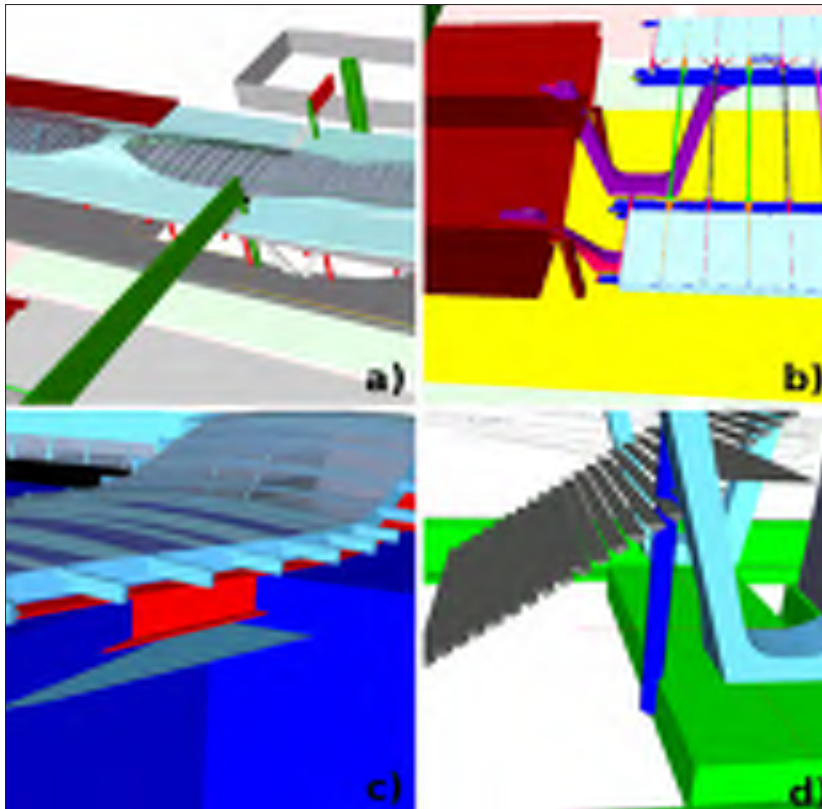


**Figure 2** Understanding the as-built situation in relation with proposed engineering designs. From point cloud to clash detection (left to right)



**Figure 3** Use of the 4D CAD model to resolve a conflict between the foundation and a temporary structure after construction work had been started. Left screen-shot: Conflict between a temporary column and a to be installed permanent column. Middle screen shot: Identifying the exact dimension of the conflict using the 4D CAD software's measurement function. Right screen shot: The existing situation on the construction site before the installation of the new permanent column

On the Arnhem Centraal project, the project management team even went a step further. On this project, it was decided that all design input from all involved parties should be provided in 3D format. These 3D models were then merged in a common model to understand the different conflicts, not only with the existing conditions, but also within the different design suggestions itself. Moreover, a construction schedule was integrated to establish a so called 4D model to understand possible conflicts and clashes during the construction of the project, Figure 4.



**Figure 4** Screen-shots showing different conflicts caused by misaligned construction sequences that were found using the 4D CAD model. The top-left screen-shot (a) shows a conflict between the overhead railway electrification system and the roof construction. The top-right screen-shot (b) shows a conflict between the demolition and installation sequence for the steel structure. The screen-shot on the lower-left (c) shows a conflict between the old and new roof structure. The bottom-right screen-shot shows a conflict between the foundation, temporary stair structure, and the new steel columns

### 3.2 Predicting delay propagation on railway networks using historical train operations data

Delay propagation is one of the hardest phenomena that railway operations managers face. The delay of a single train within a railway network will often cause delays of a large number of other trains. Predicting how delays will propagate throughout a network is complex, while the effect of delay propagation on travellers is significant. Better understanding the delay propagation is therefore a crucial part of improving the management of railway operations. This case describes the combination of two different databases available at Irish Rail to learn more about delay propagation. In particular, a system was developed that combined information of infrastructure elements, such as tracks, switches, crossings, buffer stops, with the railway networks topology and locations from GIS and CAD systems, with the historical timetable and operational data, such as the arrival and departure time of each train and all delays more than 300 seconds. Most of this information was combined using the existing information model standard RailML that allows to meaningfully model all the above information. Using these different data sources a model to predict delay propagation within the Irish network was developed using artificial neural networks. The model used the delay times, train maximum speed, route maximum speed, speed homogeneity, route departures, vertex

departures, edge length, and percentage of double tracks as input variables to predict the amount of delay propagation.

This case shows the potential of the purposeful combination of different data available at railway management organizations. In particular, the combination of data about the railway infrastructure with historical data about operations seems to be a fruitful endeavor. The developed model allows first predictions of first-order knockdown delays. This model can then be used to understand different problematic sections on the network that are main drivers for delay propagations. Railway management organizations can then use this knowledge to devise measures to mitigate delay propagation, be it through an adjustment of time-tables or through the improvement of the physical railway infrastructure.

### 3.3 Construction and maintenance of road networks

The road infrastructure is a vital component of any urban transportation system that addresses the travel demands to transport people and goods. In 2009, more than 73% of the total amount of the Tonne-kilometre of the inland goods transportation in EU employed roads as a transportation means [19]. Given the vital role for transportation, in particular for urban regions, there is a clear need for the search of ways to improve the road infrastructure. To accommodate this improvement most roads in urban areas are subject to constant construction work with the aim to rehabilitate existing roads, extend road capacity and to build new roads. Within the urban context such construction work is usually highly disruptive to the economic and social urban processes. Accelerating road construction processes is therefore of utmost importance for the seamless transformation of cities.

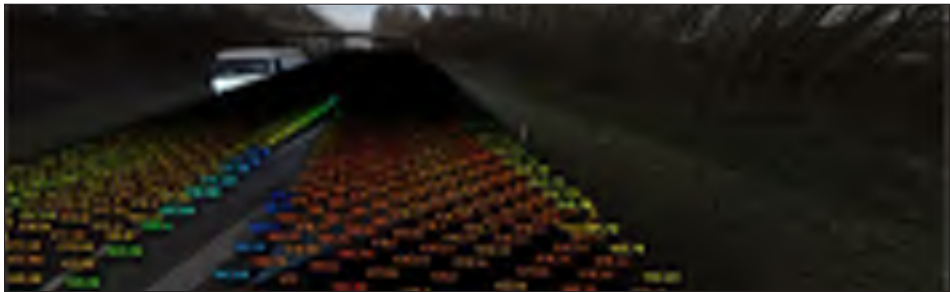
Despite this pressing need, most acceleration efforts are currently still hampered by missing understanding of how the construction process influences the quality of the finished asphalted road. This holds in particular for the compaction process. This case presents research and development work towards a data driven real-time decision support system to provide machine operators and site managers with adequate process information about ongoing road construction projects. The system is based upon measurements of asphalt temperature and GPS measurements of all involved construction plant, Figure 5. The measured data is then fused by aligning the measured time stamps and geo-referencing all information. Additionally, simulations about the predicted cooling of the asphalt temperature was integrated in the system.

In this way, the system could provide real-time visualizations of the road construction process to site managers. This allowed these managers to streamline ongoing road construction work while safeguarding quality. In particular, it was now possible to understand when to best compact a certain part of the newly asphalted road in relation to the asphalt temperature. Such understanding is an important factor for safeguarding the final road quality, because if asphalt is compacted while it is too hot, roller compactor will damage the road deck as they will sink into the too viscous asphalt. On the other hand, roller compactors will damage the road deck if the asphalt is too cold as the hardened road deck will crack under the introduced compaction energy.

In a next step this project also started to experiment with understanding the failure of road network in relation to the tracked data from the road construction. To this end, the measured data from the operations were fused and visualized together with the at the Dutch road authority existing GPS based road damage data. Figure 6 shows a first impression of this work.



**Figure 5** On site temperature measurement with an industrial temperature line scanner (left) and on-site information provision to site management staff during ongoing operations (right)



**Figure 6** Overlay of temperature measurements from a paving effort with GPS referenced video data of a highway [16]

### 3.4 Long term prediction of road network quality using historical data

Authorities responsible for planning and designing road networks, use pavement management systems to support their decision making procedures with respect to maintaining pavements in serviceable and functional conditions throughout their life-cycle. A key component of these systems, pavement prediction models play an important role. This case provides an example of how publicly available data from the US national highway administration was used to develop a machine learning prediction method to understand the factor that effect pavement deterioration.

As input for the machine learning mechanisms data from the US long term pavement performance database was used. As specific input variables the study used surface thickness, percentage of asphalt content, percentage of air void and hot mix asphalt, and unit weight of hot mix asphalt as characteristics of the asphalt. Additionally, equivalent single axial load, average annual daily traffic, and average annual daily truck traffic were used as load related input variables. Finally, with annual average precipitation, annual average temperature, and annual average freeze index two climate based variables were also used.

Using regression analysis and artificial neural networks the influence of these parameters on the international roughness index in the short and long term were predicted. Different models were developed to be used within pavement management systems to predict the performance of a specific pavement. The models also showed that the two factors of annual

average precipitation and average annual daily truck traffic had the most influence on pavement deterioration.

All in all, this case shows the possibility to implement machine learning mechanisms to make use of three different source of data available at most road management authorities: design characteristics of paved roads, traffic data about road use, and openly available weather data. By a meaningful combination of these data within an information model and by mining this information model with state of the art machine learning techniques, better prediction models for the deterioration of assets can be developed. These prediction models, in turn, will allow road management agencies to more objectively devise maintenance and repair strategies and plans.

## 4 Discussion

The above cases all describe applications of data driven decision support systems within infrastructure management and design organizations. What is common between all these cases is that they make use of available data, fuse this data meaningfully, mine the fused data, and then visualize it to support decision making tasks. What is also common between the four cases is that all of these applications were developed in a bottom-up manner driven by the decision support needs at hand. In our earlier work, we argued that only such bottom-up development will make the sound implementation of decision support systems within organizations possible [20-23]. The above cases stress the importance of this IT management strategy.

In what follows we will provide a number of suggestions for the development of information models, service oriented patterns for the interoperability between different information models, and a management framework all targeted at providing the flexibility to quickly develop and implement decision support systems as mentioned above. The recommendations are targeted to overcome some of the existing problems with information management at organizations that oftentimes is too inflexible to support the development of targeted data-driven decision support systems.

### 4.1 Information Models

An information model can be best defined as a simplified representation of a small, finite subset of the world. As such each of the objects within a model corresponds to some real or abstract object that might exist in the world or within the state of mind of a group of persons or an individual [24, 25]. Each information model can ultimately only represent a certain aspect of the world using a certain categorization and a certain level of detail [24]. Therefore, before an information model can be developed and the above described decisions about the specific form of the information model can be made a specific universe of discourse [24] and a purpose for the model needs to be identified.

After identification of the overarching universe of discourse, decisions need to be made about the level of detail to represent the object, about the degree of decomposition of objects to be represented, about how to represent the relations between objects, and about how to deal with changes to objects over time [25]. How these decisions are made does not depend on any natural law, but is largely determined by arbitrary decisions of the designers of a specific information system. These decisions will be made according to the required kinds of information for the specific purpose the information model should support and due to considerations about how a specific information model needs to be maintained while in use [25].

While making these choices it is important to consider that every information models is a computer based knowledge representation. As such it has to follow a number of within the literature well established principles [26]:

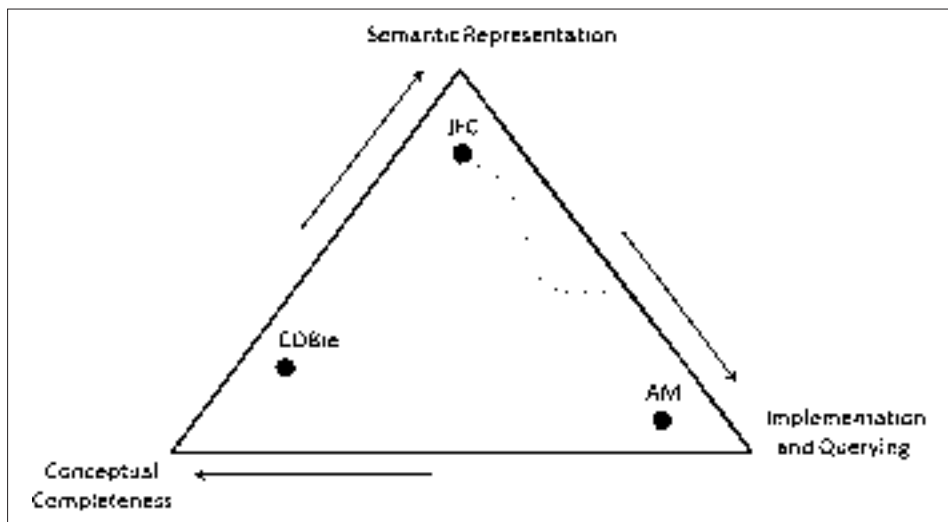
- An information model is a set of ontological commitments. The designers of a database need to agree upon categories for the things that the information model should represent. It is



important to realize that the information model only remains useful if all users of the model follow this initial ontological commitment.

- Every information model is a medium for efficient computation. It is important that every information model, not only encodes knowledge, but ensures that computers can easily process the information model and that the information model can be easily implemented with existing technology.
- An information model is also a medium of human expression. Next to ontological commitment, an information model should also support human communications of those using the information model.

From these three generally accepted principles, three different types of information models can be derived. These three types are summarized in Figure 7, labelled as semantic representation, conceptual completeness, as well as, ease of implementation and querying. The figure also depicts that each of the three quality characteristics are to a certain extent exclusive. The figure depicts that a shift of an information model towards any of the three qualities will inevitably require the reduction of the quality within the other categories. Exclusiveness, in turn, means that for different decision purposes, different information models need be established, even if they describe the same type of data.



**Figure 7** Three types of information models. The three types are to a certain extent exclusive. For example, a shift of a specific information model towards a higher quality of semantic representation will most likely reduce the conceptual completeness and the ease of implementation and querying (1). Similarly, an increase in conceptual completeness will reduce the possibilities of semantic representation and the ease of implementation, while an increase in the ease of implementation will decrease the possibilities for semantic representation and the conceptual completeness

At the outset, and probably the most important type of information models, are models that are highly semantically accurate. Every information model is an abstract representation of reality. As such, it can be seen as a computer based sign system that represents something in the real world. This sign system, in turn, has to be interpreted by somebody who wants to learn something about the real world based on the representation in the computer [27, 28, 29]. The semantic accuracy of the model to represent real world objects allowing for their adequate interpretation from various different points of view at different stages within a design process seems therefore the most important characteristic of an information model.



However, to design meaningful data driven decision support systems two other characteristics of information models are similarly important.

A second type of information models is characterized by high conceptual completeness, or in other words, the degree to which the combined system of signs can represent a specific universe of discourse at hand in its entirety and exactly. Other than semantic accuracy, conceptual completeness requires information models to closely focus on a specific engineering task often around the accurate combination of data from two different sources. To enable such specific engineering tasks a conceptually complete model needs to provide a highly accurate representation of the specific universe of discourse at hand. Redundancies in possibilities to store data related to the information models decomposition need to be avoided. This holds for the chosen categorization of objects and their respective level of detail. Additionally, highly conceptually complete models need to allow domain expert to quickly comprehend the model.

A third type of information models, finally, is targeted at optimizing computational characteristics, in particular, with respect to ease of implementation and ease of model querying. This is important because a specific information model, after all, will need to be implemented in a software system to become of any use. Here question about how well the chosen information model structure can be effectively implemented within database systems or other software and how well a specific information model can be queried and updated move to the forefront. Important then is that IT management of organizations needs to consider this requirement for different types of information models. With the necessity that any one decision support system will need to custom tailor their underlying model to the needs at hand, the question arises how organizations can manage the multiple information models that are required to support their different decision support processes ranging from the strategic to the operational level. The next sub-section provides some recommendations for the required interoperability that need to be established between different models.

## 4.2 Interoperability

According to Sowa [30], there are a number of patterns to deal with data interoperability between different data sources. The easiest pattern is a “file gateway”, a pattern quite often used within infrastructure design and planning. This pattern relies on a central gateway that is able to read files exported in the format of one information model and translates it to the other. The problem with this pattern is that there is no immediate response, it also adds complexity and additional administrative requirements. For example, file storage and versioning systems have to be designed to organize the meaningful file exchange.

A slightly more advanced pattern is the “data model transformation” pattern. In this pattern an independent software service running on a server is responsible to translate between two information models. The advantage of this pattern with respect to the “file gateway” is the immediate availability of the translated data. However, the development of good “data model transformation” services is difficult and requires a significant effort. A different service has to be developed for each pair of decision support systems that need to exchange data. Additionally, maintaining a large number of these services running in production requires additional administrative effort. Also the additional run time performance overhead should be considered, in particular, with respect to large data sources.

The “schema centralization” pattern makes use of the necessary overlap of information between different information models. It selects overlapping sub-schema from different decision support systems and decouples these sub-schema from the original information models into a central repository. Each of the different decision support systems of an organization can then make use of these common central repositories. Other than the earlier described two patterns the complexity that “schema centralization” introduces is of an organizational nature. It is very difficult to understand which sub-schema of the different deci-

on support systems can be shared within an organization. Additionally, political discussion about ownership and rights of shared schema might form a barrier to their implementation. Finally, the “canonical schema” pattern tries to develop one single information model schema to serve all purposes of an organization. While this schema is often touted as the “holy grail” of information modelling, in particular, in the current discussion about building information models, one should always bear in mind the different purposes of information models introduced in the previous section. Even in the rare case that an organization could make use of a single information model, the implementation of a canonical scheme often cannot be realized. The introduction of a “canonical schema” requires a significant governance effort and a cultural change throughout the entire organization. Designing the schema is also highly complex as all needs of the organization’s decision support systems need to be accounted for. Finally, the implementation of a “canonical schema” will inhibit the innovative potential within the organization to continuously improve its decision support systems. More often than not innovative efforts in organizations that have implemented “canonical schema” in the past were implemented outside the “canonical schema”.

Independent of what combination of schema an organization wants to implement, the infrastructure of decision support systems in relation to the different databases implementing the above patterns need to be managed. The next section, introduces a concept and framework for this management, labelled “Cooperate App Store”.

### 4.3 The corporate app store

Organizations who want to make full avail of the possibilities that data driven decision support systems offer, need to provide an IT infrastructure that is open, flexible, secure, and that support collaboration within the organization and with third parties. The concept of the corporate app-store provides a framework for the development of an IT infrastructure that fulfils all these criteria. The corporate app-store is schematically presented in Figure 8.

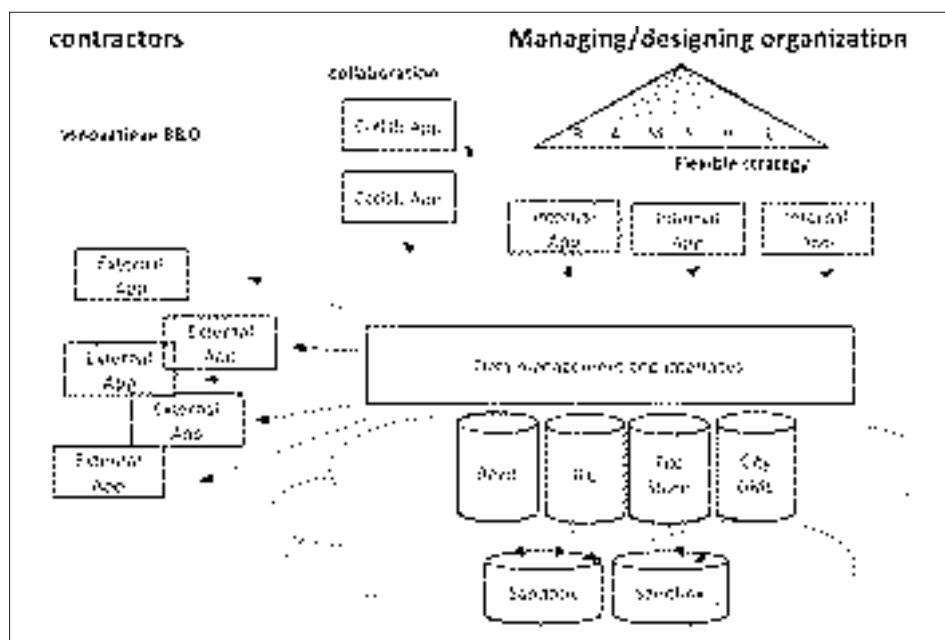


Figure 8 Architecture of a corporate app store

The main purpose of the corporate app store should be the support of the organization's strategy in terms of design and planning of the infrastructure systems. This support should account for the highest amount of flexibility of this strategy, so that the organization will be able to quickly react to changes in its environment.

Different decision making tasks at the strategic, tactical, and operational level can be supported by small self-standing applications each of which present a specific data-driven decision support system. Additionally, applications can be developed that support the collaboration with external parties. Finally, services that the organization outsources can be supported by application that are used only by sub-contractors, but that nevertheless tie into the organization's app-store.

The provision of these different applications on the basis of a central IT infrastructure is made possible by a distributed cloud based data repository. In this repository all data available within the organization should be stored in a distributed database system. At the outset, it is not important in what format the data is stored here. Different information systems and different data storage technologies should be supported, ranging from file based storage to state-of-the-art NoSQL and graph based database systems. Important is only that the data schema and schema implementation is provided openly as source code, as well as, human understandable documentation documents that clearly explain the underlying storage mechanisms as well as the information model is documented. Important is also that all data of the entire organization is stored and documented here.

On top of this distributed cloud based data storage platform, an interface layer is then constructed through which the different applications can access the data. Similar to the distributed data storage, the assumption here is that the interface level can grow evolutionary with the flexible requirements of the organization and their applications. Additionally, the interface should also be made available openly and all interfaces should be documented. Interfaces can then provide different data stored in the distributed repository to application. Interfaces can also take care of certain interoperability requirements using any of the patterns discussed in the previous section.

Having this IT architecture in place allows organizations to flexibly extend their application environment with new data driven decision support systems whenever the need arises. Because of the open nature of the app-store it is possible to develop applications internally or to outsource the application development to outside software developers. Importantly, however, is that the open character prevents the organization to become dependent on one single software company. Further, the open and evolutionary growing character of the app-store prevents organizations from implementing systems that in a number of years will be outdated, so called legacy software.

The app-store's data interface layer allows app-store architects to implement data security mechanisms. None of the distributed data stores should be directly accessed by an application, but only through a well documented and open interface. This allows for the highest amount of control and flexibility in terms of data security.

## 5 Conclusion

This paper argues that a shift in how engineers and planners work is occurring currently. Practice is moving from targeted information retrieval towards applying the vast amount of existing databases. It supports this argument by providing four illustrative cases of data driven decision support systems for the design and planning of road and railway networks and their components. Establishing the possibilities of data driven decision support systems, the paper then provides a number of recommendations for how organizations can design their IT infrastructure to support this changing practice and to make full avail of the newly arising possibilities. In particular, the paper discussed different purposes of information models,

it introduces different interoperability patterns, and finally it suggests the concept of the corporate app store as a IT implementation and management strategy.

I hope that the paper can provide some fresh insights into the quickly evolving current practice of infrastructure planning and design. Further, it is hoped that the paper can provide some fresh thoughts about how to overcome the problems of current IT management practice that is still heavily dominated by legacy systems, silo-thinking, and closed data systems. To overcome this practice in the upcoming years will be a challenge for most large organizations working in the area of infrastructure management. As it is argued in the paper a new IT management culture that operates flexible, open, transparent, and secure is required to truly support the emerging design and planning practice around data driven decision support systems.

## References

- [1] Miller, C.C.: A beast in the field: The google maps mashup as gis/2, *Cartographica: The International Journal for Geographic Information and Geovisualization* 41 (3) (2006), pp. 187-199.
- [2] Haklay, M., Weber, P.: Openstreetmap: User generated street maps, *Pervasive Computing, IEEE* 7 (4) (2008), pp. 12-18.
- [3] Anguelov, D., Dulong, C., Filip, D., Frueh, C., Lafon, S., Lyon, R., Ogale, A., Vincent, L., Weaver, J.: Google street view: Capturing the world at street level, *Computer* (6) (2010), pp. 32-38.
- [4] Swart, L.: How the up-to-date height model of the Netherlands (ahn) became a massive point data cloud, *NCG KNAW* 17.
- [5] Conradie, P., Choenni, S.: Exploring process barriers to release public sector information in local government, in: *Proceedings of the 6th International Conference on Theory and Practice of Electronic Governance, ACM*, 2012, pp. 5- 13.
- [6] Mahdavi-Amiri, A., Alderson, T., Samavati, F.: A survey of digital earth, *Computers & Graphics* 53 (2015), pp. 95-117.
- [7] Küppers, G.: *Computer simulation: Practice, epistemology, and social dynamics*, in: *Simulation*, Springer, 2006, pp. 3-22.
- [8] Hartmann, T., Olde Scholtenhuis, L., Zerjav, V., Champlin, C.: Mindfully implementing simulation tools for supporting pragmatic design inquiries, *Engineering project organization journal*, 5 (2015) 1, pp. 4-13.
- [9] Henderson, K.: Flexible sketches and inflexible data bases: Visual communication, conscription devices, and boundary objects in design engineering, *Science, technology & human values* 16 (4) (1991), pp. 448-473.
- [10] Di Marco, M.K., Taylor, J.E., Alin, P.: Emergence and role of cultural boundary spanners in global engineering project networks, *Journal of Management in Engineering* 26 (3) (2010), pp. 123-132.
- [11] Ewenstein, B., Whyte, J.: Knowledge practices in design: the role of visual representations as epistemic objects', *Organization Studies* 30 (1) (2009), pp. 07-30.
- [12] van Amstel, F.M., Zerjav, V., Hartmann, T., van der Voort, M.C., Dewulf, G.P.: Expanding the representation of user activities, *Building Research & Information* (2014), pp. 1-16.
- [13] Trebbe, M., Hartmann, T., Doree, A.: 4D CAD models to support the coordination of construction activities between contractors, *Automation in construction* 49 (2015), pp. 83-91.
- [14] Vasenev, A., Hartmann, T., Doree, A.: A distributed data collection and management framework for tracking construction operations, *Advanced engineering informatics* 28 (2) (2014), pp. 127-137.
- [15] Vasenev, A., Pradhananga, N., Bijleveld, F., Ionita, D., Hartmann, T., Teizer, J., Doree, A.: An information fusion approach for filtering GNSS data sets collected during construction operations, *Advanced engineering informatics* 28 (4) (2014), pp. 297-310.

- [16] Sluer, B., Aalbers, D., Vasenev, A.: Risico's van afwijkingen in asfaltproces te kwanti\_ceren, CROW Infradagen (2014), pp. 18-19.
- [17] Ziari, H., Sobhani, J., Ayoubinejad, J., Hartmann, T.: Analysing the accuracy of pavement performance models in the short and long terms: GMDH and ANS methods, *Road Materials and Pavement Design* (2015), pp. 1-19.
- [18] Ziari, H., Sobhani, J., Ayoubinejad, J., Hartmann, T.: Prediction of IRI in short and long terms for flexible pavements: ANN and GMDH methods, *International Journal of Pavement Engineering* (2015), pp. 1-13.
- [19] E. U. R. Federation, *European road statistics* (2011).
- [20] Hartmann, T., Fischer, M., Haymaker, J.: Implementing information systems with project teams using ethnographic-action research, *Advanced Engineering Informatics* 23 (1) (2009), pp. 57-67.
- [21] Hartmann, T., Van Meerveld, H., Vossebeld, N., Adriaanse, A.: Aligning building information model tools and construction management methods, *Automation in construction* 22 (2012), pp. 605-613.
- [22] Hartmann, T., Levitt, R.E.: Understanding and managing three-dimensional/four-dimensional model implementations at the project team level, *Journal of construction engineering and management* 136 (7) (2009), pp. 757-767
- [23] Hartmann, T.: Goal and process alignment during the implementation of decision support systems by project teams, *Journal of Construction Engineering and Management* 137 (12) (2011), pp. 1134-1141.
- [24] Turk, Z.: Phenomenological foundations of conceptual product modelling in architecture, engineering and construction, *Artificial Intelligence in Engineering* 15 (2) (2001), pp. 83-92.
- [25] Kent, W., Hoberman, S.: *Data and reality: a timeless perspective on perceiving and managing information in our imprecise world*, Technics publications, 2012.
- [26] Sowa, J.F.: *Knowledge representation: logical, philosophical, and computational foundations*.
- [27] Andersen, P.B.: *A theory of computer semiotics: Semiotic approaches to construction and assessment of computer systems*, Cambridge University Press, 1997.
- [28] Hartmann, T., Vossebeld, N.: A semiotic framework to understand how signs in construction process simulations convey information, *Advanced engineering informatics* 27 (3) (2013), pp. 378-385.
- [29] Hartmann, T.: Semiotic user interface analysis of building information model systems, *Journal of computing in civil engineering* 28 (5).
- [30] Erl, T.: *SOA design patterns*, Pearson Education, 2008.

# 1 TRAFFIC PLANNING AND MODELLING





## OPENTRACK – A TOOL FOR SIMULATION OF RAILWAY NETWORKS

Hrvoje Haramina<sup>1</sup>, Andreas Schöbel<sup>2</sup>, Jelena Aksentijevic<sup>2</sup>

<sup>1</sup> University of Zagreb, Faculty of Transport and Traffic Sciences, Croatia

<sup>2</sup> OpenTrack Railway Technology Ltd., Austria

### Abstract

OpenTrack began a few years ago as a research project at the Swiss Federal Institute of Technology. The aim of the project, Object-oriented Modeling in Railways, was to develop a user-friendly tool that would answer questions about railway operations by simulation. One of the tasks OpenTrack supports is calculation of minimum headways (headway calculation), e.g. using the OpenTrack tool Headway Calculator. Based on a number of input parameters, the headway calculator computes the minimum headway between two trains and is able to identify the critical block section. The two trains may vary in type (e.g. intercity, commuter, freight, etc.), route and stopping pattern. The headway calculation works for fixed block (discrete block), moving block and CBTC systems. During the simulation predefined trains run on a railway network according to the timetable and under the constraints of the signaling system. After a simulation run, OpenTrack can analyze and display the resulting data in the form of diagrams, train graphs, occupation diagrams and statistics.

*Keywords: Simulation of railway operation, operational performance*

### 1 Introduction

Railroad planning is particularly challenging because different improvements can be used to achieve project objectives; improvements can be divided into three general categories: infrastructure, rolling stock, and operations. Improvements in each category need to be evaluated against improvements in other categories to develop the optimal investment plan.

A good example of a structured approach to trading off different types of improvements in these categories is the Swiss National Railroad's (SBB) Integrated Product Planning Process. [1] The SBB views this process as a Planning Triangle with three elements at the corners: Products, Rolling Stock, and Infrastructure. Products are the services and schedules operated (e.g. commuter rail, intercity rail, freight); rolling stock means the type of rolling stock used to provide a particular service; and infrastructure consists of the physical system (e.g. tracks, signal systems, stations). SBB planners use iterative techniques to evaluate changes in each of these elements to optimize the system as a whole. This triangular depiction effectively communicates the relationship between the three elements and their ability to meet market demand. In an example of this process, the SBB decided to use tilting trains to provide high speed service (a rolling stock solution) rather than fully rebuilding tracks on a particular corridor (an infrastructure solution) because the former was found to be more cost effective.

Computer simulation is a particularly important and useful tool for evaluating different railroad improvement strategies for the following reasons:

- Understanding Capacity – Railway capacity is not intuitively obvious. Even lines with very little service may be operating at capacity.



- Highly Interrelated Infrastructure – An infrastructure improvement in one location can have significant impacts in another location, sometimes far from the improvement. A rail simulation program can identify the impacts of such changes throughout the modeled network.
- High Cost of Rail Infrastructure – Improving a railroad is expensive, not only are the physical improvements costly, but costs for taking a line out of service during construction and for additional right-of-way can be significant. Furthermore, a poorly planned improvement will increase the railroad's long term operating costs and problems.

Given these factors, many rail-planning experts recommend completing as much modeling as possible before starting a railroad improvement program. In general, the more modeling done up front, the less expensive the overall project will be, since modeling enables the plan to be refined to its most essential elements [2].

The first step in using computer models in the railroad planning is to calibrate the base case model. This should accurately replicate observed railroad operations with the existing infrastructure, rolling stock, and schedules. Once the model has been calibrated it can be used to investigate many issues including estimating the stability of new timetables, determining the minimum infrastructure requirements for a given timetable, or evaluating the impact of rolling stock changes. A significant benefit of models is their ability to evaluate the impact of incidents or time-based network changes (e.g. maintenance) on railroad operations.

Computer simulation is especially valuable for railroad planning since, once developed and calibrated, models can be used for the comparison of the benefits, impacts, and costs of various different improvement packages. To analyze more than a few improvement packages by hand would be prohibitively time consuming. Thus, effective railroad simulation models enable planners to identify and evaluate more alternatives, ultimately leading to more creative and comprehensive problem solutions. While computer simulation is an excellent tool for analysis and planning of railroads, railroad network simulation programs have the following limitations:

- Programs must be validated to actual conditions.
- Yard operations must be modeled separately.
- Resource constraints such as crew scheduling are largely ignored (although some specialized software does address resource constraints).
- Simulations only include the modeled study area.
- Simplifying assumptions generally create an inherent optimism about overall congestion, schedule adherence, and recoverability [3].

Given these limitations, especially the last one, it is critical that all simulation results be carefully reviewed and discussed with those familiar with operations. There is no substitute for real experience in the planning process.

## 2 OpenTrack – railway simulation software

OpenTrack was developed at the Swiss Federal Institute of Technology's Institute for Transportation Planning and Systems (ETH IVT). The project's goal was development of a user-friendly railroad simulation program that could run on different computer platforms and could answer many different questions about railway operations, [5]. Figure 1 illustrates the three main elements of OpenTrack: data input, simulation, and output.

OpenTrack is a microscopic synchronous railroad simulation model. As such it simulates the behavior of all railway elements (infrastructure network, rolling stock, and timetable), as well as all the processes between them. It can be easily used for many different types of projects, including testing the stability of a new timetable, evaluating the benefits of different long-term infrastructure improvement programs, and analyzing the impacts of different rolling stock.

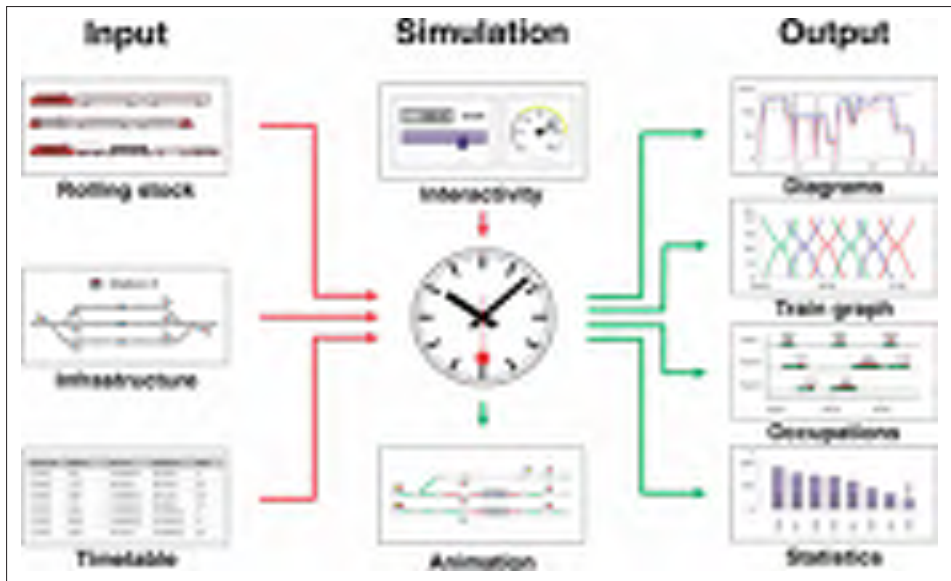


Figure 1 Data flow in simulation of railway operation

## 2.1 Input Data

OpenTrack manages input data in three modules: rolling stock (trains), infrastructure, and timetable. Users enter input information into these modules and OpenTrack stores it in a database structure. Once data has been entered into the program, it can be used in many different simulation projects. For example, once a certain locomotive type has been entered into the database, that locomotive can be used in any simulation performed with OpenTrack. Similarly, different segments of the infrastructure network can be entered separately into the database and then used individually to model operations on the particular segment or together to model larger networks.

Train data (locomotive and wagons) is entered into the OpenTrack database with easy to use forms displayed using pull down menus. Infrastructure data (e.g. track layout, signal type/location) is entered with a user-friendly graphical interface; quantitative infrastructure data (e.g. elevation) is added using input forms linked to the graphical elements. Following completion of the RailML [4] data structure for rolling stock and infrastructure, OpenTrack will be modified to enable train and infrastructure data to be directly imported from RailML data files. Timetable data is entered into the OpenTrack database using forms. These forms include shortcuts that enable data input to be completed efficiently. For example, users can designate hourly trains that follow the same station stopping pattern an hour later. Since OpenTrack uses the RailML [4] structure for timetable data, timetable data can also be entered directly from various different program output files as well as database files.

One advantage of OpenTrack is that it enables users to adjust many variables that impact railroad operations. For example, users can simulate the impact of weather on traction by specifying the adhesion scenario (good, normal, bad). OpenTrack then estimates locomotive traction power using a percentage (also user-defined) of that calculated using the Curtius and Kniffler formula, [6]. While OpenTrack provides standard default values for all variables, having the ability to adjust variables makes the program quite useful.

## 2.2 Simulation

In order to run a simulation using OpenTrack the user specifies the trains, infrastructure and timetable to be modeled along with a series of simulation parameters (e.g. animation formats) on a preferences window. During the simulation, OpenTrack attempts to meet the user-defined timetable on the specified infrastructure network based on the train characteristics. OpenTrack uses a mixed continuous/discrete simulation process that allows a time driven running of all the continuous and discrete processes (of both the vehicles and the safety systems) under the conditions of the integrated dispatching rules.

The continuous simulation is dynamic calculation of train movements based on Newton's motion formulas. For each time step, the maximum force between the locomotive's wheels and the tracks is calculated and then used to calculate acceleration. Next, the acceleration function is integrated to provide the train's speed function and is integrated a second time to provide the train's position function. [6]

The discrete simulation process models operation of the safety systems; in other words, train movements are governed by the track network's signals. Therefore, parameters including occupied track sections, signal switching times, and restrictive signal states all influence the train performance. OpenTrack supports traditional multi-aspect signaling systems as well as new moving block train control systems (e.g. European Train Control System – ETCS signaling). OpenTrack is a dynamic rail simulation program. As such, the simulated operation of trains depends on the state of the system at each step in the process as well as the original user-defined objective data (e.g. desired schedule).

A simple way of describing dynamic rail simulation is that the program decides what routes trains use while the program is running. For example, when building the network, users identify various different routes that trains can use between two points; OpenTrack decides, during the simulation, which route the train will use by assigning the train the highest priority route available. If the first priority is not available, OpenTrack will assign the train the second highest priority route and so on.

OpenTrack's dynamic nature allows users to assign certain attributes to specified times in the simulation. Thus, users can assign a delay to a particular train at a given station and time, rather than being limited to assigning a delay at the start and using it through the entire simulation. Similarly, users can define other types of incidents (e.g. infrastructure failures, rolling stock breakdowns) for particular times and places.

Finally, dynamic simulation enables users to run OpenTrack in a step-by-step process and monitor results at each step. Users can also specify exactly what results are displayed on the screen. Running OpenTrack in a step-by-step mode with real time data presented on screen helps users to identify problems and develop alternative solutions.

## 2.3 Output

One of the major benefits of using an object-oriented language is the great variety of data types, presentation formats, and specifications that are available to the user. During the OpenTrack simulation each train feeds a virtual tachograph (output database), which stores data such as acceleration, speed, and distance covered. Storing the data in this way allows users to perform various different evaluations after the simulation has been completed.

OpenTrack allows users to present output data in many different formats including various forms of graphs (e.g. time-space diagrams), tables, and images. Similarly, users can choose to model the entire network or selected parts, depending on their needs. Output can be used either to document a particular simulation scenario or as an interim product designed to help users identify input modifications for another model run. [7]

### 3 Use of OpenTrack in Croatia

Figure 2 shows a detailed outline of Zagreb Gl. kolodvor infrastructure. The importance of any modelling system lies in the accurate representation of reality. For this reason, OpenTrack takes all important parameters into consideration, so that everything that happens during simulation will happen in reality as well.



Figure 2 Infrastructure: Zagreb Glavni kolodvor

Another example of infrastructure layout is depicted in Figure 3. The station Hrvatski Leskovac is presented with all tracks, signaling system and needed infrastructure characteristics.



Figure 3 Infrastructure: Hrvatski Leskovac

Figure 4 shows an example of a train graph with blocking time stairway between Zdencina and Karlovac, Croatia, including distance, as well as information about double- and single-track sections.

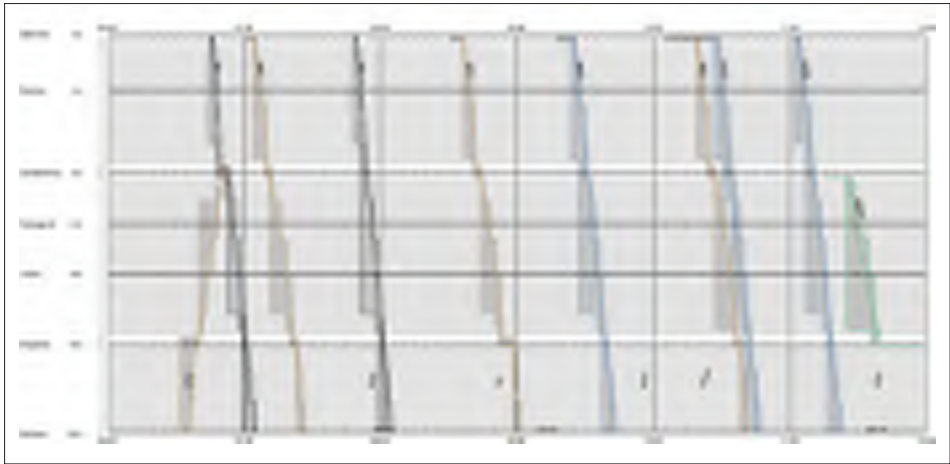


Figure 4 Timetable with block section: Zdencina – Karlovac

## 4 Conclusion

OpenTrack is an efficient and effective railroad simulation program. It has been used successfully in many different railway planning projects throughout the world. The program's use of object-oriented programming and the RailML data structure makes it particularly effective since the program can be modified relatively easily to address specific applications and since data can be transferred easily to and from other programs based on RailML. Therefore, it is highly recommended to use it for simulation of railway operations because it covers a wide range of possible output data that can be used in decision making processes.

## References

- [1] Grossenbacher, P.: Service Planning Strategies: The Example of the Passenger Transport Department of the Swiss Federal Railways. Rail International, June/July 2001, 118.
- [2] Nash, A.: Best Practices in Shared-Use Rail Operations; Mineta Transportation Institute, San Jose State University; San Jose, California; June 2003.
- [3] Gibson, J.: Train Performance Calculators and Simulation Models. Handout, Transportation Research Board, "TRB Workshop on Railroad Capacity and Corridor Planning." January 13, 2002.
- [4] For more information on RailML see the project website: [www.railml.org](http://www.railml.org)
- [5] Huerlimann, D.: Object oriented modeling in railways; ETH Dissertation Nr. 14281; 2001 (in German).
- [6] Huerlimann, D., Nash, A.: OpenTrack – Simulation of Railway Networks. User Manual Version 1.3; ETH Zurich, Institute for Transportation Planning and Systems; May 2003; Page 58.
- [7] For more information on OpenTrack see the project website: [www.opentrack.ch](http://www.opentrack.ch)
- [8] Theeg, G., Vlasenko, S.: Railway Signalling & Interlocking. DVV Media Group. 2009. ISBN 978-3-7771-0394-5.
- [9] Schoebel, A., Volcic, M.: Microscopic Simulation of Railway Operation for Developing Integrated Timetables; 3<sup>rd</sup> International Conference on Road and Rail Infrastructure – CETRA 2014, 28-30 April 2014, Split, Croatia



## CRITERIA FOR URBAN TRAFFIC INFRASTRUCTURE ANALYSES – CASE STUDY OF IMPLEMENTATION OF CROATIAN GUIDELINES FOR ROUNDABOUTS ON STATE ROADS

Mateo Kozić<sup>1</sup>, Sanja Šurdonja<sup>2</sup>, Aleksandra Deluka-Tibljaš<sup>2</sup>, Barbara Karleuša<sup>2</sup>,  
Marijana Cuculić<sup>2</sup>

<sup>1</sup> *Signalinea d.o.o., Croatia*

<sup>2</sup> *University of Rijeka, Faculty of Civil Engineering, Croatia*

### Abstract

Implementation and reconstruction of urban traffic infrastructure has proved to be very complex task because of different reasons. Among the most important are those connected with negative influence of motorized traffic on urban environment (congestions, safety, environmental problems) and those connected with urban surrounding (lack of free space, ambientality). During last decades there was great increase of reconstruction of standard intersections into roundabouts all over the middle Europe (Slovenija, Croatia, Italy ect.). Because of that the need to have objective and comprehensive estimation of the implementation of roundabout at the place of standard three or four leg intersection was established. In different countries were set, we can conclude based on different national regulation, similar criteria. Croatian Guidelines for Roundabouts at State Roads were adopted by authorities for state roads Hrvatske ceste in 2014. They prescribe estimation and comparison of solutions in the case of new or reconstruction of existing intersection into roundabout. The goal of this paper is to discuss proposed criteria by comparing it with widely used criteria for traffic infrastructure planning and design commonly used for urban traffic infrastructure. The suitability and universality of proposed criteria will be tested on two case studies where guidelines were implemented: four leg signalised intersection and three leg non signalized intersection situated in different urban context.

*Keywords: urban infrastructure, criteria, roundabout*

### 1 Introduction

Implementation and reconstruction of urban traffic infrastructure has proved to be very complex task because of different reasons among which the most important are those connected with negative influence of motorized traffic on urban environment and on wider urban surroundings. This is why evaluation of urban infrastructure includes criteria connected with engineering solution and economics of the solution but also different social and environmental criteria too [1]. Overall used criteria for planning, design and construction of urban traffic infrastructure can be divided in four groups: traffic criteria, environmental criteria, social criteria and economic criteria.

Traffic criteria include different aspects of traffic efficiency of proposed solution and, if applicable, increase in traffic safety. Environmental criteria are connected with all of the negative effects of traffic, especially motorized traffic on air, water and land. Social criteria measure how many people and sometimes also which groups (with the emphasis of different vulnerable groups) will benefit (or not) from new infrastructure. Economic criteria takes into consideration the costs of construction and maintenance of traffic infrastructure.

During last decades there was great increase of reconstruction of standard intersections into roundabouts all over the middle Europe (meaning Slovenija, Croatia, Italy ect.). Because of that the need to have objective and comprehensive estimation of the implementation of roundabout at the place of standard three or four leg intersection was established [2, 3, 4]. Also in different countries were set, we can conclude based on different national regulation, similar criteria [5-10]. Croatian Guidelines for Roundabouts at State Roads (further in the text Croatian Guidelines) were adopted by authorities for state roads Hrvatske ceste in 2014 [5]. They prescribe estimation and comparison of solutions in the case of new or reconstruction of existing intersection into roundabout.

In this paper an analyses and comparison of criteria used in different national regulation is done in order to make an objective assessment of criteria and methodology proposed in Croatian Guidelines. Methodology for assessing roundabout design at different location, set in the Croatian Guidelines, are applied as case study on two different intersections. The aim was to test proposed criteria for different types of intersections (three and four leg, signalised and non signalised) and in different urban context (inside the city, on the border of the city) planned for reconstruction in roundabout.

## 2 Criteria for roundabout implementation

There is no uniform guidelines in Europe for geometric design of roundabouts as specific circumstances differ among countries. Design elements as well as criterion for acceptability of roundabouts are usually defined in national guidelines adapted to their circumstances [11].

### 2.1 Overview of usually used criteria for roundabout implementation

In the book “Kružne raskrsnice-Rotori”, author Zoran Kenjić, mentions 4 main criteria that should be considered when making decisions on the justification of the construction a certain type of the intersection [8]. Similar, 8 criteria acceptable for standard one or two lane roundabouts suggests the author of the book “Alternative Types of Roundabouts” [11]. The suggested criterion are: functional, spatial, capacity, design, traffic-safety, front-and-rear, economical and environmental. Analyses of different available guidelines from European countries and USA use many common criteria although some differences, due to different traffic culture, can be recognised. In Table 1 comparison of criterion in different guidelines is shown.

**Table 1** Comparison of usually used criteria for roundabout

Countries	Criteria	Application	Year of publication
Croatia [5]	1) functional criterion 2) spatially-urbanistic criterion 3) traffic flow criterion 4) design and technical criterion 5) traffic safety criterion 6) capacity criterion 7) environmental criterion 8) economic criterion	State roads	2014.
Slovenia [6]	1) functional criterion	State roads	2011.
Serbia [7]	2) capacity criterion 3) spatial criterion 4) design and technical criterion 5) traffic safety criterion 6) economic criterion		2012.



**Table 1** Comparison of usually used criteria for roundabout (continued)

Countries	Criteria	Application	Year of publication
Netherland [9]	1) road function criterion 2) capacity criterion 3) road safety criterion 4) policy of traffic management; 5) spatial possibilities or limitations; 6) capital and maintenance costs.	N/A	2009.
USA [10]	1) considerations of context 2) potential applications 3) planning-level sizing and space requirements 4) economic evaluation 5) public involvement	N/A	2010.

Some of criteria are very common. In all of analysed guidelines we can find economical, traffic and design criterion. As specific can be seen criteria “policy of traffic management” in Netherlands Guidelines which emphasises the importance of consistent traffic policy when some parts of road network is analysed. In the USA Guidelines specific criteria is “public involvement” which, in developed countries such as USA, has great importance when some new infrastructural objects are planned or constructed.

## 2.2 Croatian guidelines for roundabouts at state roads

First Croatian guidelines for roundabouts were adopted in 2002. [12] and they made important step in standardisation of roundabout design practice. However, after more than 10 years of intensive implementation of roundabouts in Croatia there was a need to revise and upgrade the Guidelines. Upgrade done in Guidelines from 2014. [5] are mainly connected with more detailed explanation of the design principles, introduction of some new types of roundabouts and introduction of obligatory procedure for estimation of roundabout projects.

In this new guidelines estimation and comparison of solutions for roundabouts with those for standard intersection became obligatory for all state roads. The suggested methodology proposes 8 criteria through which the solutions are analysed and compared. Comparison can be made between non-signalised intersection and roundabout and between signalised intersection and roundabout. Proposed criteria are:

- **Functional criterion:** analyses the primary role of the intersection under consideration in the road network and in general;
- **Spatially-urbanistic criterion:** analyses potential roundabout location and sensitivity of certain zones to the planned changes;
- **Traffic flow criterion:** comprises the verification of the circumstances of the present intersection, relating to the overall level of traffic flow, and to the – direction of traffic flow at the intersection;
- **Design and technical criterion:** analyses the circumstances on the subject intersection that are related to the geometry of the intersection, to the position, number and angle of intersection approaches;
- **Traffic safety criterion:** analyses if the roundabout, in the existing conditions, is the solution that guarantees the safety for all road users.
- **Capacity criterion:** analyzes possible traffic capacity and quality of traffic flow (level of service) for certain types of intersection;
- **Environmental criterion:** analyses whether and how much implementation of roundabout contributes to the improvement of the intersections environment and wider;
- **Economic criterion:** analyses the cost-effectiveness of roundabout implementation at the particular location.



The criteria can be grouped as commonly used criteria for urban infrastructure (Table 2). Some of the criteria can be connected with one and some with more than one standard groups which points that they cover the problem well.

**Table 2** Criteria for urban infrastructure

Standard group of criteria for urban traffic infrastructure	Criteria from Croatian guidelines for roundabouts
Traffic	Capacity, traffic flow, functional criteria, design (technical) criteria
Social	Traffic safety, functional criteria, spatial criteria
Environmental	Environmental criteria, spatial criteria
Economical	Design criteria, economical criteria

### 3 Case study

The methodology and criteria proposed in Croatian Guidelines were applied on two different standard intersections in urban part of Rijeka City [13]. Urban in this case means area close to city centre with road network used by motorised and non-motorised users, pedestrians and possibly also cyclists.

Case study 1 was three leg non-signalised intersection situated at the east entrance to Rijeka City and case study 2 was four-leg signalised intersection situated inside city network.

For both intersections deep analyses based on criteria defined in Croatian Guidelines for roundabouts at state roads was done. In order to make the analyses it was necessary to: make design of roundabout with all geometric elements, test horizontal and vertical alignment of new roundabout design with existing road network, analyse data about traffic accidents, make capacity analyses for roundabout and existing intersection, make analyses of level of air pollution for both solutions [13].

#### 3.1 Case study 1: Three-leg non signalized intersection [13]

Analysed three-leg non signalized intersection is situated on crossing of XIII divizije Street and Janka Polić Kamova Street. The intersection serves as an east entrance/exit for Rijeka City and connects Rijeka as primary center with close secondary center Kostrena, Bakar and Kraljevica. The intersection lost it's role as an important transit point after Rijeka ring was opened few years ago so present traffic volumes are smaller than they were. In near surrounding of the intersection there are city beaches so during summer season there is intensive pedestrian traffic in the intersection zone.

Because of the shape and open space around existing intersection it was not a problem to design roundabout of medium size with the radii of 18 m and with all standard dimensions, circulatory lane with width of 6,5 m and approaching lanes with width of 3,25 – 5,73 m. The control of turning path was done for all of possible driving directions for design vehicle as well as the control of visibility from all approaches, shown in the Figure 2.

For design purposes the traffic volume counting and capacity estimation was done. For capacity of roundabout approaches the commercial computer program Sidra Intersection was used. That computer program is based on non-linear Australian method and on the basis of geometry and load volumes gives output on average delay, saturation of approach lane and finally level of service. For analysed location results of capacity calculation for standard three-leg intersection and for designed roundabout show that both solutions can satisfy present level of traffic at the intersection as well as the projected traffic for next years. The average level of service (LOS) for present solution is B and for roundabout is A. The estimated CO emissions happened to be much favorable at roundabout than on standard intersection presently in function (Figure 3).



Figure 1 Present situation at intersection Case study 1 (left) and roundabout design at the same location (right) [13]

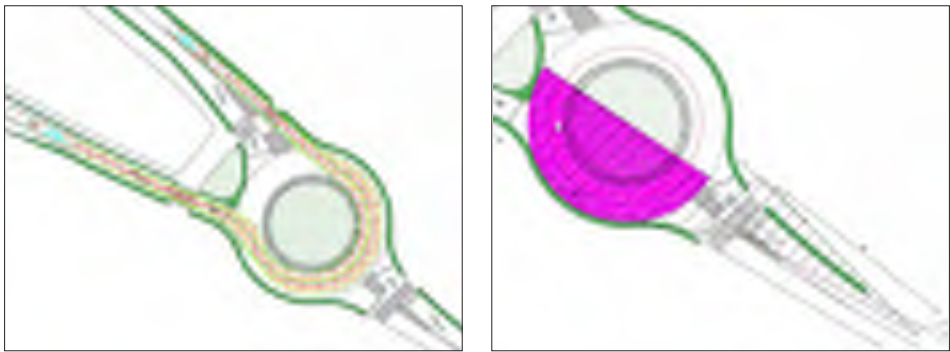


Figure 2 Turning paths for design vehicle (left) and visibility control (right) – examples [13]



Figure 3 Pollution – CO emissions for standard intersection (left) and roundabout (right) [13]

Roundabout solution has the advantage that in the case of good LOS the cars are not forced to stop at the approach, the traffic flow is continuous and the level of pollution in that case lower than on the standards intersection in similar conditions.

Finally, the traffic safety indicators were analysed. The data about traffic accident during last 5 years were collected from authorities and potential conflict spots were analysed too. In number of potential conflict points roundabout has general advantage not to have conflict point of crossing type so it is almost always better solution than any type of standard intersection on which crossings of traffic directions cannot be avoided. As for the traffic accidents the analyses show that most frequent type of accident is impact from the back. As it is type of

accident that is very common on roundabouts in this case proposed solution cannot improve the traffic safety significantly.

### 3.2 Case study 2: Four-leg signalized intersection [13]

Analysed four-leg signalized intersection (Figure 4) is situated on the crossing of street coming from the direction of center part of the Rijeka City – 1. Maja Street (approach 4), street coming from residential as well as very developed commercial city zone around Osječka Street (approach 2) and two streets coming from mostly residential areas Tizianova Street (approach 1) and Kresnikova Street (approach 3). The main direction is the one connecting city center and residential-commercial zone around Osječka Street not only because of it's traffic role as commercial street but also because of the transit role that Osječka Street has in city road network. It is a two-lane corridor (Osječka – 1. Maja ) with significant traffic volumes, the statistics collected by city transportation firm Rijekapromet shows an average ADT on that corridor of 5500 / per lane during week days.



Figure 4 Present situation at intersection Case study 2 (left) and roundabout design at location (right) [13]

Because of the densely built-up area on the eastern side of the intersection, present intersection located in curve and on slope, it was not an easy task to implement roundabout with standard geometric elements on the location. The designed solution is medium size roundabout with radii of 18 m and with all standard dimensions, circulatory lane with width of 6,5 m and approaching lanes with width of 3,25 – 5,73 m. The control of turning path was done for all of possible driving directions for design vehicle as well as the control of visibility from all approaches, shown in the Figure 5.



Figure 5 Turning paths for design vehicle (left) and visibility control (right) – examples for approach 1 [13]

For design purpose the traffic volume counting and capacity estimation was done. For capacity of roundabout approaches the commercial computer program Sidra Intersection was used. For analysed location results of capacity calculation for signalised four-leg intersection and

for designed roundabout show that both solutions have unsatisfactorily LOS for some of the directions. With roundabout solution great problem is approach 4 (1. Maja) which is one of the main directions with great traffic volumes and which, in this case, has LOS D. This is why the conclusion is that roundabout cannot satisfy traffic volumes at the location.

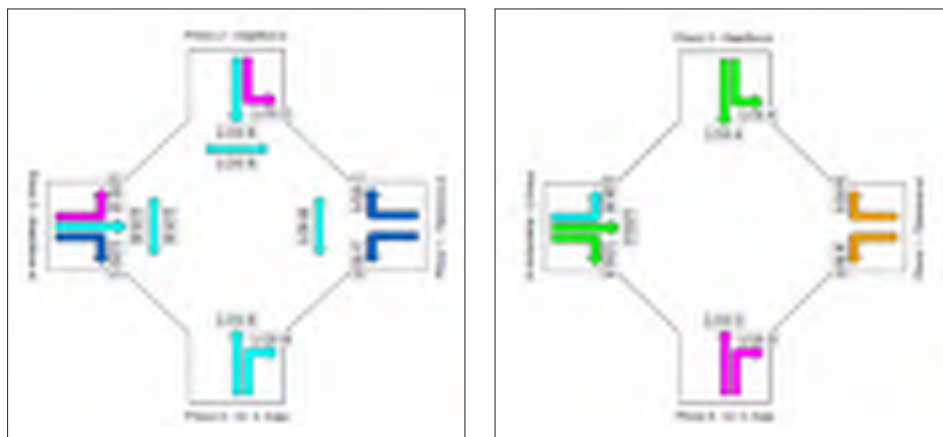


Figure 6 Level of service for present intersection (left) and for roundabout (right) [13]

The estimated CO emissions happened to be much favorable for all approaches at present signalized intersection than on the roundabout. The result have to do with greater LOS and calculated stops at the approaches for roundabout solution (Figure 6).

### 3.3 Case study – conclusion

Case study showed that proposed criteria can be easily and with high level of reliability implemented for estimation of roundabouts in the case of reconstruction of existing standard intersection. As lots of data can be collected directly on the site it is possible to make objective analyses and assessment of proposed solution as well as the comparison with existing intersection.

## 4 Conclusion

Analyses of literature as well as of the existing national guidelines for roundabouts show that analyses of the acceptability of roundabout is necessary step in their application at the location of new or reconstructed intersection. The need was recognized in Croatian guidelines in which 8 criteria, comparable with those used widely in Europe and in USA, were defined. Criteria set in Croatian Guidelines were tested on two different case studies. They proved to be sensitive enough for application on the location of signalized and non-signalized existing intersection. In both cases analyzes of criteria pointed that roundabout is not an optimal solution for analyzed location but because of different reasons. In case study 1 (non-signalized intersection on the border of the city) the roundabout solution proved to be expensive and not justified by the traffic need. In case study 2 (signalized intersection with high traffic volumes) roundabout wasn't able to satisfy capacity and it proved to have more negative impact to the environment than exiting standard four leg signalized intersection.

In both cases positive was that for all of the measurable criteria there was possibility to collect data on the site (number of traffic accidents, traffic volumes) which made positive effect on the quality of comparison of the solutions. In next step the methodology has to be tested for estimating application of planned roundabout without possibility to collect data on the site, as it is the case when planning a completely new intersection.

## Acknowledgements

This paper is a result of project “Sustainable design of pavement structures in urban areas” supported by University of Rijeka. The equipment used for the research is funded by European Union through project “Razvoj istraživačke infrastrukture na Kampusu Sveučilišta u Rijeci”.

## References

- [1] Karleuša, B., Dragičević, N., Deluka-Tibljaš, A.: Review of multicriteria-analysis methods application in decision making about transport infrastructure, *Građevinar* 65 (2013) 7, pp. 619-631
- [2] Barišić, I., Jurković, S., Tollazzi, T.: Provjera opravdanosti primjene kružnog raskrižja određivanjem vrijednosti utjecajnih čimbenika, *Suvremeni promet*, 26, 3-4; pp. 220-226, 2006.
- [3] Breški, D., Cvitančić, D., Stazić, T.: Metodologija vrednovanja i usporedbe varijantnih rješenja raskrižja. *Suvremeni promet*, 30, 3-4; pp. 213-218, 2010.
- [4] Deluka-Tibljaš, A., Babić, S., Cuculić, M., Šurdonja, S.: Possible reconstructions of intersections in urban areas by using roundabouts. *CETRA 2010*, Zagreb: Zavod za prometnice, Građevinski fakultet, Sveučilište u Zagrebu, pp. 171-178, 2010.
- [5] Smjernice za projektiranje kružnih raskrižja na državnim cestama, Naručitelj: Hrvatske ceste d.o.o. Zagreb, Izrađivač: Građevinski fakultet Sveučilišta u Rijeci, Rijeka, 2014.
- [6] Tehnička specifikacija za javne ceste TSC 03.341:2011 – Kružna križišča, Republika Slovenija, Ministarstvo za promet, 2011.
- [7] Priručnik za projektovanje puteva u Republici Srbiji. Beograd: Funkcionalni elementi i površine puteva. Kružne raskrsnice, JP Putevi Srbije, 2012
- [8] Kenjić, Z.: Kružne raskrsnice- rotori, Priručnik za planiranje i projektiranje, Sarajevo, 2009
- [9] Roundabouts – Application and Design: A practical manual (Dutch) Ministry of Transport, Public Works and Water management, Partners for Roads, 2009.
- [10] Rodegerdts, L., Bansen, J., Tiesler, C., Knudsen, J., Myers, E., Johnsonm, M., Moule, M., Persaud, B., Lyon, C., Hallmark, S., Isebrands, H., Crown, R.B., Guichet., B., O'Brien, A.: Roundabouts: An Informational Guide, Second Edition. NCHRP Report 672, Washington, DC, US. 2010.
- [11] Tollazzi, T.: *Alternative Types of Roundabouts*, Springer, 2015.
- [12] Institut prometa i veza 2002: Smjernice za projektiranje i opremanje raskrižja kružnog oblika-rotora, Zagreb
- [13] Kozić, M.: Analiza primjenjivosti novih hrvatskih smjernica za kružna raskrižja na državnim cestama, Diplomski rad, Sveučilište u Rijeci, Građevinski fakultet, 2015.



## MODELLING TRAVEL BEHAVIOR OF RAILWAY PASSENGERS UNDER TRAVEL TIME UNCERTAINTY

Kazuyuki Takada, Kota Miyauchi  
*Tokyo Denki University, Japan*

### Abstract

Reliability of travel time affects travel behavior such as departure time decision, transportation mode choice and also route choice. Therefore, the influence of travel time uncertainty of urban railway on railway commuters was focused on in this study.

Internet survey was conducted to collect data from railway commuters living in Tokyo metropolitan area. Stated preference for railway service was executed in the survey. Four alternatives were presented to the respondent and each respondent was requested to choose the most preferable service. Average travel time, shortest travel time, longest travel time uncertainty, variability of travel time, congestion level in a vehicle and fare were considered as the compared factors. Meanwhile, it is thought that extent of interest in travel time reliability depends on trip purpose. Therefore, four kinds of trip purpose were considered in the survey. Four kinds of trip purpose were to commute, to attend business meeting, to go shopping and to go to airport. The data obtained by the stated preference choice experiments was used for parameter estimation of railway service choice model. At first, multinomial logit model were estimated by trip purpose and the weight for the travel time uncertainty was verified.

Subsequently, latent class logit model was estimated and the validity of considering multiclass to estimate choice behavior model was examined. According to the Bayesian information criterion, it was demonstrated that latent class logit model was more useful to explain the choice behavior in travel for shopping and going to airport.

*Keywords: travel time reliability, stated preference survey, choice model, latent class model*

### 1 Introduction

Reliability of travel time is one of the factors affecting travel behavior such as departure time decision, transportation mode choice and route choice. Therefore, travel time reliability of urban railway in Tokyo metropolitan area was focused on in this study and influence of the uncertainty of travel time on travel behavior of railway passenger was quantitatively analyzed. Internet survey was conducted by utilizing a commercial net-survey services. Targeted respondents of the survey were people commuting by rail. The number of samples was 1000. Stated preference choice experiments of urban railway service was executed in the survey. Travel time, uncertainty of the travel time, walking time from arrived station to destination, fare and congestion level were considered as the variables determining level of service.

Using the choice result data, disaggregate choice model such as multinomial logit model and latent class logit model were estimated. As a result, it became clear that a negative evaluation for the travel time uncertainty is larger when people goes to airport and business meeting than when people goes to office and shopping.

## 2 Questionnaire survey

### 2.1 Outline of survey

Internet survey was conducted in this study. Survey monitors contracted with a commercial survey company were respondents of the survey. Screening of the monitors was executed to select appropriate respondents to the survey. The respondents were railway commuters living in Tokyo metropolitan area. Outline of the survey is described in Table 1. Main question item for this study is stated preference experiments regarding railway service choice. The details of the experiment are described in the following section.

**Table 1** Outline of the survey

<b>Dates</b>	28, 29 March 2015
<b>Targeted railway users</b>	Commuter using railway Frequent railway user (more than 5 day a week) Residents in Tokyo metropolitan area
<b>Question items</b>	Socio-economic attributes Current status of railway use (origin and destination, transit station, frequency of railway use, estimates of travel time, desired arrival time at arrival station, departure time, distribution of arrival time, encounter the delay of railway operation, etc.) Stated preference experiments (under supposed eight scenarios)
<b>Samples</b>	1000

### 2.2 Stated preference experiments

A stated preference experiment is useful survey method to collect data when revealed preference data does not exist. Many previous studies conducted stated preference experiment in order to develop a travel behavior model.

For example, Basu et al. conducted stated preference experiment to capture the data of sub-urban train mode choice behavior and estimated choice model using different modelling techniques such as multinomial logit and mixed logit model [1]. Meanwhile, Mabit et al. focused on the international long-distance travel preferences related to travel between Scandinavia and Central Europe. They conducted stated preference survey to collect data in order to develop a discrete choice model estimating the value of travel time savings of long-distance travellers [2]. Carrion et al. reviewed many previous studies investigating travel time variability and conducting stated preference experiment [3]. In this study, a stated preference experiment was also conducted and obtained data was used to estimate discrete choice model regarding urban railway service choice.

**Table 2** Summary of the attributes and levels used in the choice experiment

<b>Average travel time</b>	40 min, 45 min, 47 min
<b>Shortest travel time</b>	30 min, 35 min, 40 min, 45 min
<b>Longest travel time</b>	45 min, 50 min
<b>Standard deviation of travel time</b>	0 min, 4.47 min, 8.94 min
<b>Walking time from station to destination</b>	2 min, 5 min
<b>Congestion ratio in the vehicle</b>	100%, 200%
<b>Fare</b>	JPY 500, JPY 800

In the experiments, average travel time, shortest travel time, longest travel time, variability of travel time, walking time from arrived station to final destination, congestion level in vehicle



and fare were considered as the variables determining level of service. The design of stated preference experiment was executed by setting appropriate value for each variable. Table 2 shows the adopted value for the experiment.

Meanwhile, Figure 1 and 2 show the questionnaire used for the choice experiments. Four services having different level of service were presented to each respondent and the respondent was requested to choose most preferable service. The experiment was conducted two times for each trip purpose so that totally every respondent answered eight questions.



Figure 1 Stated preference experiment (business meeting)

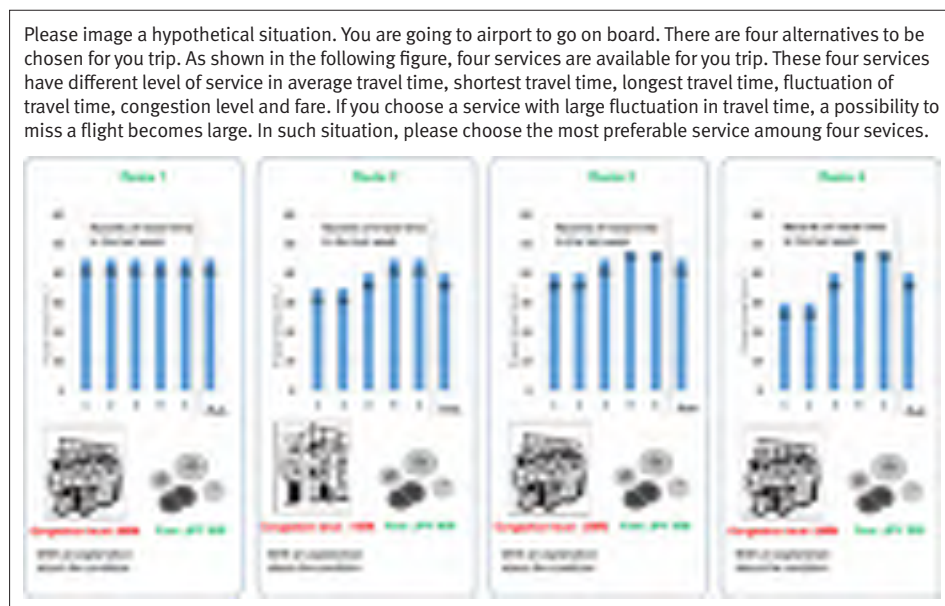


Figure 2 Stated preference experiment (for going to airport)



Choice experiment was executed two times for each trip purpose. Table 3 shows the result of the choice experiments. Value in the table indicates the number of respondent choosing each alternative. Each alternative is sorted in order of having high chosen ratio. As shown in the table, more than half respondent chose certain alternatives. However, other alternatives were also chosen in all experiments. It indicates the existence of the heterogeneity of the preference for railway service.

**Table 3** Results of the choice experiments

Experiments	Most high ratio	2 <sup>nd</sup> most	3 <sup>rd</sup> most	4 <sup>th</sup> most
1. Commuting (1 of 2)	640	185	118	57
2. Commuting (2 of 2)	593	196	131	80
3. Business meeting (1/2)	667	201	69	63
4. Business meeting (2/2)	618	186	126	70
5. Shopping (1/2)	411	247	205	137
6. Shopping (2/2)	571	191	172	66
7. Going to airport (1 of 2)	452	322	119	107
8. Going to airport (2 of 2)	539	282	117	62

### 3 Estimation of choice model

#### 3.1 Multinomial logit model

At first, multinomial logit model was applied to estimate coefficients of service choice model. The considered explanatory variables alter by trip purpose. Average travel time (ATT), shortest travel time (STT), longest travel time (LTT), standard deviation of travel time (SDTT) and walking time from arrival station to destination (WTSD) were considered in the model of business purpose trip. In addition to the variable for the model of business trip, congestion level in vehicle (CLV), and fare (FARE) were considered in the model for personal trip. Table 4 shows the result of parameter estimation for each trip purpose. Appropriateness of sign and statistical significance were confirmed. The column of t-test shows the statistical significance level. The asterisks \* and \*\* indicate that the coefficients are statistically different from zero at the 5% and 1% level respectively.

**Table 4** Estimation of multinomial logit model (MNL)

Purpose	Commuting	Business Meeting	Shopping	Going to airport
ATT (min.)	-0.69 *	-0.53 *	-0.82 **	-0.38 *
STT (min.)	-0.07	-0.08	-2.53 **	-0.08
LTT (min.)	-0.23 *	-0.09	-1.31 *	-0.19 *
SDTT (min.)	-3.52 **	-7.13 **	-0.33	-4.56 **
FARE (JPY 100)	-	-	-0.38 *	-0.26 *
CLV (100%)	-	-	-0.25 *	-0.10
Log-likelihood	-2119	-2031	-2428	-2329
Adjusted R-squareds	0.23	0.27	0.12	0.16
Hit ratio	61.7%	64.3%	49.1%	49.6%
Observations	2000	2000	2000	2000

\*: 0.05 significance level \*\*: 0.01 significance level

Here, the relation between trip purpose and evaluation for travel time uncertainty is examined. Sign of the coefficient of SDTT are minus for all trip purpose. It demonstrates the existence of negative evaluation for the travel time uncertainty. Coefficient of STDD of the model for shopping is not significant. According to the largeness of the coefficients for other three models, people take care of the travel time uncertainty especially for going to business meeting. Meanwhile, the explanatory power of the models for shopping and going to airport are lower than other models for commuting and business meeting. It is thought that one of the reasons is no consideration of the heterogeneity of the preference for the service. Therefore the latent class model (LCM) was adopted to consider the heterogeneity by referring previous studies [4-7].

### 3.2 Latent class logit model

The latent class model with different numbers of segments was estimated and model performance was assessed in order to determine the best number of segments. In this study, the minimum Bayesian information criterion (BIC) was adopted as the indicator [8]. BIC is defined as  $-2 \cdot \ln(L) + K \cdot \ln(N)$ , where L is the likelihood value, K is the number of parameters and N is the sample size. Table 5 shows the BIC of the LCM and it indicates that the best number of segments are 1, 1, 2 and 2 for the model of commuting, business meeting, shopping and going to airport respectively.

Table 6 shows the estimation result of the LCM for shopping and going to airport. As shown in the table, a model was estimated for each class. The size of class is shown in the table. Moreover, hit ratio increases by applying LCM which means that the validity of the LCM is verified.

**Table 5** BIC of LCM by trip purpose and number of classes.

Number of classes	Commuting	Meeting	Shopping	Airport
1	4445.6	4291.5	5160.2	5225.1
2	4473.3	4328.2	5132.1	5181.4
3	4499.8	4364.9	5202.1	5265.5
4	4532.1	4401.9	5226.7	5297.2

**Table 6** Estimation of latent class mode (LCM)

Purpose	Shopping		Going to Airport	
	Class-1	Class-2	Class-1	Class-2
ATT (min.)	-0.54 *	-1.11 **	-0.33 *	-0.36 *
STT (min.)	-0.86 *	-2.32 **	-0.18	-0.13
LTT (min.)	-0.21	-1.84 *	-0.12	-0.09
SDTT (min.)	-1.94 **	-0.82	-4.65 **	-2.63 **
FARE (JPY 100)	-0.23	-0.40 *	-0.35 *	-0.12
CLV (100 %)	-0.78 **	-0.38	-0.61 *	-0.14
Latent class size	67.1%	32.9%	76.2%	23.8%
Hit ratio	64.5%		63.1%	
Observations	2000		2000	

\*: 0.05 significance level    \*\*: 0.01 significance level

Each class of the model for shopping is examined. The significant coefficients are different in each model. Class-1 considers travel time uncertainty but Class-2 does not do so. Meanwhile, Class-2 considered fare.

Similarly, each class of the model for going to airport is examined. Class 1 considers the travel time uncertainty stronger than Class-2. Moreover, Class-1 takes care of fare and congestion level.

## 4 Conclusion

In this study, the travel time uncertainty of railway service was focused on. In order to examine the evaluation of railway user to the uncertainty, discrete choice mode was developed. To estimate the parameter of the choice model, internet questionnaire survey was conducted and stated preference experiment was executed in the survey.

The choice model was developed by trip purpose. Four kinds of situation such as commuting, attending business meeting, shopping, and going to airport were considered.

The multinomial logit model was developed and it becomes clear that the traveller going to business meeting mostly consider the travel time uncertainty.

Meanwhile, both models for shopping and for going to airport did not present enough explanatory power as indicated by the hit ratio so that the latent class model was adopted to develop the model that can consider the heterogeneity of the preference for railway service. According to the BIC, it was indicated that the best number of segment is two for both trip purposes. Then the latent class model with two classes was estimated and evaluated. Finally, it was verified that the latent class logit model can predict choice result more precisely in case for shopping and going to airport.

## References

- [1] Basu, D., Douglas, Hunt, J.D.: Valuing of attributes influencing the attractiveness of suburban train service in Mumbai city: A stated preference approach, *Transportation Research Part A: Policy and Practice*, 46, pp. 1465-1476, 2012.
- [2] Mabit, S.L., Rich, J., Burge, P., Potoglou, D.: Valuation of travel time for international long-distance travel – results from the Fehmarn Belt stated choice experiment, *Journal of Transport Geography*, 33, pp. 153-161, 2013.
- [3] Carrion, C., Levinson, D.: Value of travel time reliability: A review of current evidence, *Transportation Research Part A: Policy and Practice*, 46, pp. 720-741, 2012.
- [4] Boxall, P. C., Adamowicz, W.: Understanding heterogeneous preferences in random utility models: a latent class approach, *Environmental and Resource Economics*, 23, pp. 421–446, 2002.
- [5] Lee, B., Timmermans, H.J.P.: A latent class accelerated hazard model of activity episode durations, *Transportation Research Part B: Methodological*, 41, pp. 426-447, 2007.
- [6] Wen, C., Wang, W., Fu, C.: Latent class nested logit model for analysing high-speed rail access mode choice, *Transportation Research Part E: Logistics and Transportation Review*, 48, pp. 545-554, 2012.
- [7] Koster, P.R., Koster, H. R.A.: Commuters' preferences for fast and reliable travel: A semi-parametric estimation approach, *Transportation Research Part B: Methodological*, 81, pp. 289-301, 2015.
- [8] Walker, J.L., Li, J.: Latent lifestyle preferences and household location decisions. *Journal of Geographical Systems*, 9, pp. 77–101, 2007.



## EVALUATION OF THE CALIBRATED MICROSIMULATION TRAFFIC MODEL BY USING QUEUE PARAMETERS

Irena Ištoka Otković<sup>1</sup>, Matjaž Šraml<sup>2</sup>

<sup>1</sup> Josip Juraj Strossmayer University of Osijek, Faculty of Civil Engineering, Osijek, Croatia

<sup>2</sup> University of Maribor, Faculty of Civil Engineering, Transportation Engineering and Architecture, Slovenia

### Abstract

Application of microsimulation models in traffic analysis is a common professional practice. Methodology of calibration of microsimulation models is not finally adopted and various approaches are available. One of the available calibration methods is neural network approach for calibration of microsimulation traffic model. The comparison of the simulated and measured traffic indicators, in real traffic conditions, provides the best insight into the success of the model calibration process. The traffic indicator, used for the calibration of the model, is the travel time between the measuring points at a chosen urban intersection. The calibrated model has predicted the travel time for new sets of measured data at the same intersection with the prediction error smaller than 5%.

This paper analyses the simulation results for the traffic indicators that were not used in the model calibration – the queue parameters. The selected queue parameters are the maximum queue at the entrance and number of stops at the intersection entrance. The model has been additionally applied to the other intersection, in order to simulate its queue parameters. This has provided us with an insight into the issue of whether the calibration model is applicable only to the intersection for which the calibration has been done or it can have a wider application. The VISSIM microsimulation traffic model was used for calibration, and two single-lane roundabouts served as the research basis for evaluation of the calibrated traffic microsimulation model by means of queue parameters.

*Keywords: queue parameters, microsimulations, VISSIM, roundabouts*

### 1 Introduction

Microsimulation models are frequently used in traffic analysis. They are able to model the stochastic nature of traffic flow at a multi-modal level, through a detailed movement modelling of each entity and its interactions. Microsimulation traffic model, which enables a detailed analysis and a large number of iterations in real time, is based on testing of various traffic scenarios. Modelling results of each scenario are comparable. They focus on the analysis of alternative solutions, short-term traffic planning or optimization of particular elements of traffic objects and/or evaluation of specific traffic regulation. The microsimulation models are, undeniably, a very useful tool, but it is questionable whether they can be expected to give realistic modelling results that can be applied in the methodology, analysis and the design in local conditions.

The functioning of a traffic system is under the influence of various aspects of human behaviour [1]. Studies show that the behaviour of traffic participants is, among other things, territorially and culturally conditioned [2]. Microsimulation models include variable behaviour

of drivers, at a level of each particular entity, and the reality of modelling results depends on the initial choice of the model [3] and the efficiency of the calibration process [4].

In the calibration process, the parameters of traffic microsimulation models are adjusted in such manner, that the model outputs are similar to the observed data. According to the Highway Capacity Manual, calibration is the process of comparing model parameters with actual data obtained by counting and measuring at a local network [4]. Identification of influential parameters, the range of their values and optimization of these parameters and their values by some of the optimization tools, are an integral part of the calibration process [5-7]. In the last few years, there has been a lot of research work aimed at the procedures for calibration of traffic microsimulation models, but there have been no attempts to identify general calibration principles, based on the collective experience of the researchers [8].

Some studies deal with traffic calibration of microsimulation models, and they concentrate only on the calibration of driving behaviour parameters [9, 10], but some others [11-13] incorporate this issue in a research of a broader problem, which includes the calibration of a route choice model [14] and an origin-destination matrix too [15]. Analysis of acceptable time gaps and determination of a critical time interval by means of Greenshield's model [16] represent a description of the calibration method for the VISSIM microsimulation model at roundabouts in New York.

The method of calibration of microsimulation traffic models evaluated in this paper is the one using neural network approach. Calibration methods, based on the neural network prediction, have been analysed and the results show that a neural network is applicable in the process of calibration of microsimulation traffic models [17].

## 2 Evaluation of the calibrated traffic microsimulation model

A traffic microsimulation model typically consists of several sub-models, each of which trying to reproduce the mechanism of a single decision made by an individual driver, such as the decision to change lane or to use a gap in the opposing traffic in order to enter an intersection. Each sub-model includes several parameters, and a complete traffic microsimulation models sometimes include dozens of parameters.

The VISSIM microsimulation traffic model has been chosen for the analysis of the calibration process. Testing of all combinations of model input parameters by applying realistic VISSIM simulations (separately run for every combination) would be very time consuming. A computer can examine a great number of combinations of input values of model parameters in real time, if it can use a program for output simulation values of the observed microsimulation traffic model (e.g. of VISSIM).

In Fig. 1 a simplified scheme of program calibration is presented. The program calibration begins with the creation of a VISSIM simulation database for neural network training (Fig. 1). The task of the neural network is to predict the time of travel between measuring points for particular values of input parameters, obtained by the microsimulation model. The program calibration (MATLAB) calls the prediction function, provided by the neural network within the calibration program (subroutine), for each combination of values of input parameters within the given ranges of values and by a chosen/defined step [17].

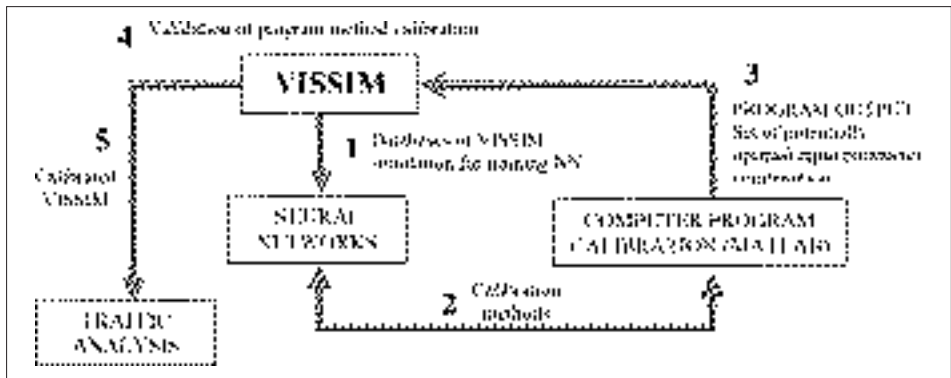


Figure 1 Scheme of computer program calibration [17]

The most common indicator used for calibrations of traffic models is the travel time [8,11,18]. In accordance with the best practice, the traffic indicator, which is used for the calibration of the examined traffic microsimulation model, is the travel time between the measuring points at a chosen urban intersection. The calibrated model has predicted the travel time for new sets of measured data at the same intersection with the prediction error smaller than 5% [20]. The model validation is the evaluation of the efficiency of the calibration model by comparison between modelled and measured traffic parameters. The validation stage is meant to confirm the predictive power of the calibrated model, using an independent set of data. However, it is important to ensure that the validation test does not simply repeat what has already been tested in the calibration process. The basic requirement, which every calibrated traffic microsimulation model must meet, is that it can be successfully validated with a new set of data of the same type. A higher standard of validation is reached, if it can be confirmed that the model calibrated with one type of data can also give good estimates of other types of traffic data, such as queue length or flows, [8].

In this case, for the purpose of the model validation, two queue parameters were selected – the maximum queue at an entrance and the number of stops at an intersection entrance. The queue parameters are the traffic indicators that were not used in the model calibration. The selected parameters are also easy to measure in the real traffic conditions, as is the case with the travel time between the measuring points. As the research basis for the evaluation of the calibrated traffic microsimulation model using queue parameters, two single-lane roundabouts were utilized.

## 2.1 Comparison of the calibrated and non-calibrated model outputs and the measured data

The calibration of the model has been done on the roundabout 1 (Vinkovačka – Drinska) by travel time observation for left turn traffic streams (from Drinska to Vinkovačka South). The validation of the model has been done by the comparison of the calibrated and non-calibrated (default) model outputs of queue parameters and the measured data at all entrances into the first examined intersection (Tables 1).

**Table 1** Comparison of the calibrated and non-calibrated model outputs

<b>ROUNDBABOUT 1</b>						
Entrance	MAXIMUM QUEUE (m)			NUMBER OF STOPS		
	calibrated	default	measured	calibrated	default	measured
<b>FIRST MEASURING</b>						
1	27	24	26	88	84	89
2	108	108	110	660	646	685
3	24	21	25	30	30	31
4	65	65	62	333	304	324
<b>SECOND MEASURING</b>						
1	22	15	21	58	60	61
2	106	106	103	462	509	475
3	18	23	18,5	34	14	33
4	60	60	62	225	204	221
<b>THIRD MEASURING</b>						
1	15	23	15,5	52	50	54
2	107	77	110	152	178	158
3	17	17	18	15	14	15
4	46	37	48	135	129	140

*1 – Drinska; 2 – Vinkovačka North; 3 – Bosutska; 4 – Vinkovačka South*

The fourth set of measured data has been gathered at the other urban roundabout (Opatijska – Kirova) with the aim to check if the calibrated model is applicable only to the roundabout at which the calibration was done or it can be applied wider (Table 2).

**Table 2** Comparison of the calibrated and non-calibrated model outputs – fourth measuring

<b>ROUNDBABOUT 2</b>						
Entrance	MAXIMUM QUEUE (m)			NUMBER OF STOPS		
	calibrated	default	measured	calibrated	default	measured
1	22	27	23	58	50	56
2	5	5	5	6	5	6
3	18	18	18,5	18	13	19
4	13	12	12,5	18	18	18

*1 – Sportska; 2 – Obilaznica; 3 – Opatijska; 4 – Kirova*

### 3 Discussion

At the heart of any calibration technique, there is a comparison between simulation outputs and gathered measurements of various traffic indicators. A comparison of the traffic indicators, the ones measured in the field and the ones simulated with the calibrated and non-calibrated microsimulation traffic model, provides an insight into the efficiency of the calibration procedure. The basic requirement, that every calibrated traffic microsimulation model must meet, is that it can be successfully validated with a new set of data of the same type. In this case, it is the traveling time between the measurement points. A higher standard of validation is reached, if the model calibrated with traveling times data can also give good estimates of other parameters such as queue parameters – the maximum queue and the number of stops at the entrance of intersection.

According to [18], the model approximates the real traffic conditions well, if the criteria for the observed traffic indicators are satisfied (1).

$$\left| \frac{Q_{\max_{\text{MOD}}} - Q_{\max_{\text{MEAS}}}}{Q_{\max_{\text{MEAS}}}} \right| \text{ and } \left| \frac{\text{STOP}_{\text{MOD}} - \text{STOP}_{\text{MEAS}}}{\text{STOP}_{\text{MEAS}}} \right| \leq 5\% \quad (1)$$

Where:

- $Q_{\max_{\text{MOD}}}$  – modelled maximum queue at the entrance;
- $Q_{\max_{\text{MEAS}}}$  – measured maximum queue at the entrance;
- $\text{STOP}_{\text{MOD}}$  – modelled number of stops at the entrance;
- $\text{STOP}_{\text{MEAS}}$  – measured number of stops at the entrance.

The comparison of VISSIM simulation results for calibrated and non-calibrated (default) model and the measured values of queue parameters, according to the formula (1), is presented in the Tables 3 and 4.

**Table 3** Comparison of the simulated and the measured traffic parameters –first location

<b>ROUNDAABOUT 1</b>				
Entrance	MAXIMUM QUEUE (%)		NUMBER OF STOPS (%)	
	calibrated	default	calibrated	default
<b>FIRST MEASURING</b>				
1	3,85	7,69	1,12	5,62
2	1,82	1,80	3,65	5,70
3	4,00	16,00	3,23	3,23
4	4,84	4,84	2,78	6,17
<b>SECOND MEASURING</b>				
1	4,76	28,57	4,92	1,64
2	2,91	2,90	2,74	7,20
3	2,70	24,32	3,03	57,58
4	3,23	3,23	1,81	7,69
<b>THIRD MEASURING</b>				
1	3,23	48,39	3,70	7,41
2	2,73	30,00	3,80	12,70
3	5,56	5,56	0,00	6,67
4	4,17	22,92	3,57	7,86

**Table 4** Comparison of the simulated and the measured traffic parameters – fourth measuring, second location

<b>ROUNDAABOUT 2</b>				
Entrance	MAXIMUM QUEUE (%)		NUMBER OF STOPS (%)	
	calibrated	default	calibrated	default
1	4,35	17,39	3,57	10,71
2	0,00	0,00	0,00	16,7
3	2,70	2,70	5,26	31,58
4	4,00	4,00	0,00	0,00

The analysis of the two parameters of the queue (Tables 3 and 4) shows that the calibrated microsimulation model provides good results of modelling with regard to the measured value of parameters in actual traffic conditions. In conditions of a low traffic load (Table 3, third measuring and Table 4), even the calibrated model provides the results that are a little bit more



than 5% different from the measured values, but the differences are not significant (5.56% and 5.26%). For the first parameter, the maximum length of queue, the result shows that the vehicles in real conditions had a greater stop distance between the vehicles in queue. For the second parameter, the number of stops at the entrance, indicates a little bit longer reaction time of drivers in the local traffic network under conditions of low traffic load.

## 4 Conclusion

The traffic indicator, which is used for calibration of the model, is the travel time between the measuring points at the selected urban single-line roundabouts. The comparison of travelling times between measuring points shows that the calibrated microsimulation model gives results that differ from the measured values of the travelling time by less than 5%, and such modelling results are considered to be realistic. This paper has analysed the simulation results for the other parameters that were not used in the model calibration – the maximum queue and the number of stops. The parameters of queue for both intersections are measured and compared to the outputs of the parameters modelled with the calibrated and the non-calibrated (default) model.

The results show that the model was successfully calibrated. The calibrated model simulation results have provided the expected accuracy in relation to the measured traffic parameters for the traveling time, as well as for the queue parameters. By using a calibrated microsimulation model VISSIM, it is possible to obtain results that reflect realistic traffic characteristics at the examined roundabouts in local conditions.

## References

- [1] Onieva, E., Milanés, V., Villagrà, J., Pérez, J., Godoy, J.: Genetic optimization of a vehicle fuzzy decision system for intersections, *Expert Systems with Applications*, 39, pp. 13148–13157, 2012
- [2] Olstam, J. J., Tapani, A.: Comparison of queue models, Swedish national road and transport research institute, Project VTI meddelande 960 A, Linköping, Sweden, 2004
- [3] Fang, F. C., Elefteriadou, L.: Some guidelines for selecting microsimulation models for interchange traffic operational analysis, *Journal of Transportation Engineering*, 131(7), pp. 535–543, 2005
- [4] Highway Capacity Manual 2000, Transportation Research Board, National Research Council, Washington D.C., 2000
- [5] Park, B., Won, J., Yun, I.: Application of microscopic simulation model calibration and validation procedure: a case study of coordinated actuated signal system, *Journal of Transportation Research Record*, TRB, National Research Council, Washington D.C., pp. 113-122, 2006
- [6] Park, B., Qi, H.: Development and Evaluation of Simulation Model Calibration Procedure, 84<sup>th</sup> Annual Meeting, Transportation Research Board, Washington D.C., 2005
- [7] Ištoka Otković, I., Tollazzi, T., Šraml, M.: Analysis of the influence of car-following input parameters on the modelled travelling time, *Tehnički vjesnik*, no. 5; pp. 919-925, 2013
- [8] Hollander, Y., Liu, R.: The principles of calibrating traffic microsimulation models, *Transportation* 35(3), pp. 347-362, 2008, DOI:10.1007/s11116-007-9156-2
- [9] Kim, K.O., Rilett, L.R.: Simplex-based calibration of traffic microsimulation models with intelligent transportation systems data, *Transp. Res. Rec.* 1855, pp. 80–89, 2003
- [10] Kim, K. O., Rilett, L. R.: A genetic algorithm based approach to traffic microsimulation calibration using ITS data. In: *Proceedings of the 83<sup>rd</sup> TRB Annual Meeting*, Washington D.C., 2004
- [11] Toledo, T., Koutsopoulos, H.N., Davol, A., Ben-Akiva, M.E., Burghout, W., Andreasson, I., Johansson, T., Lundin, C.: Calibration and validation of microscopic traffic simulation tools – Stockholm case study. *Transp. Res. Rec.* 1831, pp.65–75, 2003

- [12] Ben-Akiva, M.E., Darda, D., Jha, M., Koutsopoulos, H.N., Toledo, T.: Calibration of microscopic traffic simulation models with aggregate data. In: Proceedings of the 83<sup>rd</sup> TRB Annual Meeting, Washington D.C., 2004
- [13] Dowling, R., Skabardonis, A., Halkias, J., McHale, G., Zammit, G.: Guidelines for calibration of microsimulation models: framework and application. In: Proceedings of the 83<sup>rd</sup> TRB Annual Meeting, Washington D.C., 2004
- [14] Flötteröd, G., Chen, Y., Nagel, K.: Behavioral calibration and analysis of a large-scale travel microsimulation. *Networks and Spatial Economics*, 12(4), pp. 481–502, 2012
- [15] Flötteröd, G., Bierlaire, M., Nagel, K.: Bayesian demand calibration for dynamic traffic simulations. *Transportation Science*, 45(4), 541–561, 2011
- [16] Cicu, F., Illotta, P. F., Bared, J., Isebrands, H.: VISSIM calibration of roundabouts traffic performance, In: Transportation research board annual meeting, Washington D.C., 2011
- [17] Ištoka Otković, I., Tollazzi, T., Šraml, M.: Calibration of microsimulation traffic model using neural network approach, *Expert systems with applications*, 40, pp. 5965-5974, 2013
- [18] Kim, S.J.: Simultaneous calibration of a microscopic traffic simulation model and of matrix, Ph dissertation, Texas A&M University, 2006
- [19] Ištoka Otković, I., Zagvozda, M., Šraml, M.: Comparison between modelled and measured traveling time in urban roundabouts, In: Lakušić, Stjepan (Ed), *Road and Rail Infrastructure III (CETRA 2014)*, Građevinski fakultet Zagreb, Zagreb, 2014, pp.269-274





## NEW INDICATORS FOR NEW INFRASTRUCTURE

Harald Frey<sup>1</sup>, Anna Mayerthaler<sup>2</sup>, Ulrich Leth<sup>1</sup>

<sup>1</sup> Vienna University of Technology, Institute of Transportation, Research Center of Transport Planning and Traffic Engineering, Austria

<sup>2</sup> Neue Urbane Mobilität Wien GmbH, Austria

### Abstract

The share of people living in cities is increasing worldwide. This makes public space in cities a scarce good. Subsequently not only the challenges in the transport system are increasing but also the availability and distribution of public space is a crucial aspect. Pedestrian priority zones, strolling or encounter zones and road designs such as shared space are a first attempt to tackle the exclusive claim of space by one single transport mode, which was predominantly the car in the recent decades. For example the concept of public long-term parking contradicts the flexible use of public space by reserving it for one mode; therefore space reserved solely for the car should consequently be reduced.

One attempt to promote walking as a transport mode is the claim for minimum widths of newly constructed or rebuilt pavements. This is already established in the current Viennese planning guidelines. Still the question remains if this quality indicator is sufficient and how it should be dealt with for spaces where no physical cut-off by a kerbstone between road and pavement exists. Therefore in this paper we recommend the adoption of a new indicator – called “space-time” (space multiplied by time, m<sup>2</sup>h). This new indicator takes into account a more flexible allocation of space for new road designs that consider the needs of non-motorized traffic such as shared space. We show that a short temporal impairment of quality for some road users can be accepted if a significant increase of space efficiency and traffic quality for the eco-modes (walking, cycling and public transport) is achieved overall. Depending on the occupancy rate and quality of infrastructure, the efficiency of “space-time” can serve as an empirical basis for prioritizing transport modes and urban transport policy measures.

*Keywords: Public space, indicators, efficiency, space-time*

### 1 Introduction

In the past, public space was perceived as transitory space to operate the maximum possible traffic flow of individual motorized traffic [1]. In order to plan traffic infrastructure, different modes of transport have been and are still calculated into “car units”. For example one cyclist equals 0.25 car units [2]. According to this school of thought streets were designed and planned for decades for the use of cars, which led to the understatement and insufficient consideration of active modes.

The allocation of public space is the key factor to enable “mobility for all”. In Vienna 65 % of street space are used for the moving individual motorized traffic or as parking space [1]. This restricts the possibilities for a multifunctional use of public space. Additionally growth of the urban population is increasing the challenges in the transport system and the demands for the usage of public space. In order to enhance sustainable and active modes of transport, the availability and accessibility of public space is essential [3].

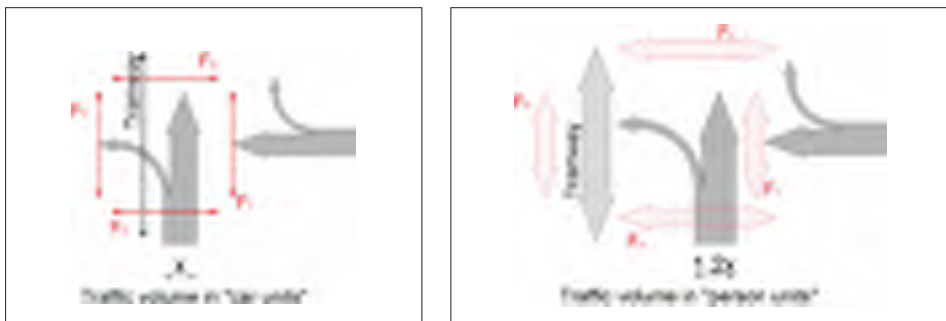
## 2 Indicators and description of complex systems

It is solely possible to determine the behaviour of complex systems through indicators. Indicators are pathfinders in describing system behaviour. They need to be simple, easy to determine, sensitive to policy measures, goal oriented and need to capture the characteristics of the structure. Indicators can give information about the state of complex circumstances and reduce complexity of phenomena due to the reduction of several dimensions into one figure or number. They are used to give a good overview of the status of an actual situation, trace developments and make trends visible [4].

The main indicators in the transport system should be derived by “higher-level” objectives in ecology, resource depletion, sociology, economy, etc. Hence indicators, which capture the efficient use of public space or the body’s own energy investment, etc. are necessary and should be seen as “first level” indicators. Typical transport indicators like volumes of traffic flow or the level of service for car traffic play a minor role and should follow superior objectives in order to measure the impact of planned policy measures [4]. Measurements based on wrong or defective indicators can increase problems especially in the long-term (e.g. reduction of congestion by building additional lanes) [5]. Understanding of system behaviour is necessary to choose and interpret the indicator accurately.

### 2.1 Design and planning of transport systems based on “wrong” indicators

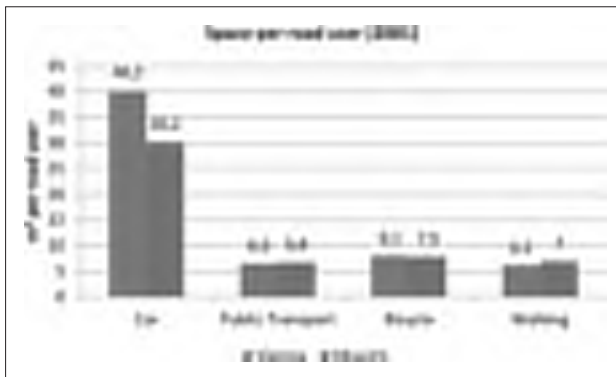
In the past the transport system was designed and planned car-oriented, based on car-centred indicators. The conversion of various road users and different types of vehicles into “car units” has led to an insufficient dimensioning of road space. Physically active modes were allocated on the remaining areas of the road space not reflecting the higher capacity of pedestrians, cyclist and public transport (compared to car traffic) at a constant availability of space. Traffic infrastructure serves the purpose of transporting people and goods. Despite the higher capacity of pedestrians, cyclists and public transport, they are often insufficiently represented in planning guidelines. As a result, physically active forms of mobility, such as walking and cycling, were allocated on “remaining areas” at the roadside.



**Figure 1** The traditional representation of “traffic” only occurred in car-units which massively deformed the view on real capacities and traffic volumes. Using the indicator of “person units” shows a complete different picture [6].

### 2.2 “Space efficiency”

The mass motorization has dramatically changed the availability and distribution of public space. Before that road space was a used as multifunctional space not solely dedicated to the motorized individual traffic. With an increasing share of the population living in cities the demands for the usage of public space are increasing and available public space is a scarce good.



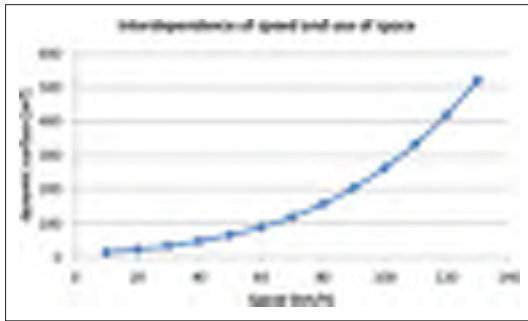
**Figure 2** 2/3 of street space in Vienna is used for lanes [7]. Car drivers use 6-times more space compared to other road users [8].

The share of pedestrian zones in Vienna is roughly 1 % of the municipal roads (despite an increase by 20 % since 2003). Taking into consideration pavements and divisional islands the share of traffic space mainly used by pedestrians, increases to 30 % [7]. Comparing the space consumption (in m<sup>2</sup>/person) of pedestrians and cars (as a function of car occupancy and speed) the result is a ratio of 1:60 [9].

### 2.3 Influence of the speed on “space efficiency”

Hitherto existing publications to the topic of “space efficiency” have taken into consideration comparisons between the consumption of space for different modes of transport as a function of speed [10] [9] [6]. In doing so the advantages of the non-motorized modes as well as the public transport can be shown. Pedestrians and public transport, such as bus, tram and underground with a high occupancy rate are the most efficient transport modes [6]. Héran et al (2008) [11] are indicating the disproportionately increasing space consumption with increasing speeds.

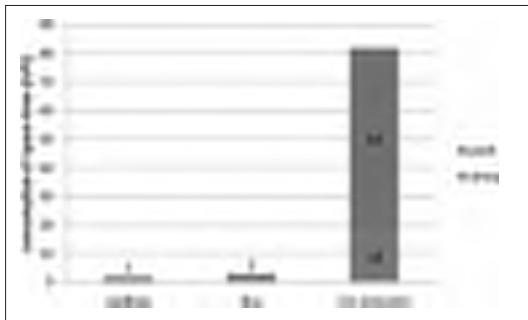
The introduction of pedestrian priority zones and shared space are first attempts to set off the paradigm of space dedication to solely one transport mode. The rededication of road space to a multifunctional use corresponds to the long tradition in cities and villages. Precondition for this multifunctionality is a suitable infrastructure, e.g. design elements, which make a road a shared space.



**Figure 3** Length of the vehicle, braking distance of a car, reaction time and lateral distance determine the amount of (required) surface with increasing speed [11].

For concepts such as shared space common used indicators such as space consumption as a function of speed are not suitable any more. New solutions are necessary for the assessment of quality parameters in cases where no physical cut-off between pavement and road space exist, for example in the case of a minimum width for pavements. If the time dimension is considered, the efficiency of multifunctional space, such as in shared space, temporary markets, bus lanes, pavement cafés and temporary road blockages in front of schools, should not be neglected in planning.

As pointed out beside the space efficiency the temporal demand of public space is significant for a quantitative assessment. The indicator measuring the usage of public space has to be enriched by the time component making it “space-time” (space multiplied by time,  $m^2h$ ). The foundation of this indicator can be found in the works of Marchand [12] [13]. He differentiates between “space-time” for parked vehicles and the moving traffic [12].



**Figure 4** Area x time consumption for a 5 km length trip (total: 10km) and 8 hours of parking ( $8m^2$ ). For the trip purpose “work” Marchand calculated the usage of road- and parking space for walking, public transport (50 people/Bus, no bus lanes) and individual motorized traffic (1.25 persons/car).

**Table 1** “Space-time” from Merchand [12] and Héran [11] (supplemented for tram)::

Mode	space-time *) ( $m^2h/pers.km$ )	speed	Occupancy rate ( $pers./vehicle$ )
Pedestrian	0,2 – 0,3	4	1
Two-wheels	0,5 – 0,75	12-15	1
Car	1,2 – 1,8	18	1,25
Bus	0,3-0,07	10-12	50
Tram	0,07-0,11	12-14	100

\*) as a function of the dynamic space-time

Knofacher presents the consumption of space for different modes of transport as a function of speed. In doing so the advantages of the non-motorized modes as well as the public transport can be shown. Pedestrians and public transport, such as bus, tram and underground with a high occupancy rate are the most efficient transport modes [6].

Beside the high space consumption for the individual motorized transport in moving traffic, especially the space consumption of parked cars needs to be considered. Long-term parking in public space totally contradicts the flexible use of road space and therefore needs to be reduced consequently [14].

### 3 Planning guidelines interpreted as guidelines not as dogma

A feasibility study for an inner city tramway line in Vienna showed that for a small section of the road new built pavements would be smaller than 2.00 meters width. In the current situation the space distribution equals a typical inner-city cross-section with traffic lane, parking spaces and pavements. In order to accept the necessity of undercutting the minimum pavement width for newly built pavements, it was proposed that this road section should be closed for individual motorized traffic, allowing just tramway and non-motorized modes and would be designed as a shared space. This would have led to temporal impairments in the case of encounters between tramway and pedestrians, but would have increased the overall situation for the active modes and public transport.

Looking at the distribution of space at a typical cross-section (2.00 meter sidewalk on both sides, 2.00 meter parking spaces on both sides, 6.50 meter road, total width 14.50 meter, length of the section 500 meter, 8,000 average daily traffic (ADT) the “space-time” potential for this section is 174,000 m<sup>2</sup>h. 48,000 m<sup>2</sup>h are reserved for parking, 9,000 m<sup>2</sup>h are occupied for moving traffic with cars (with an occupancy rate of 1.25 people/vehicle, resulting in 10,000 people). The road itself consumes 78,000 m<sup>2</sup>h. Roughly 12% of time the road is used.

With an (low) occupancy-rate of 50 people per tramway only 200 trams would be necessary to transport the same number of people through this section. This would consume only 1,000 m<sup>2</sup>h. The road would be used for transporting purposes for only 1.2 % of the time. For the remaining time the space could be used for other purposes or the active modes. Figure 5 shows space efficient designs for inner-city streets following the principle of pedestrianized areas with tramways.



**Figure 5** Road cross-section with tramway and pedestrian zone (Vienna, Austria & Gent, Belgium) as examples for a efficient and human-oriented design of transport infrastructure and public space.



## 4 Conclusions

Pedestrian zones or shared spaces combined with public transport are a suitable instrument to achieve efficient inner-city transport capacities in passenger traffic and an efficient usage of the public space. Side roads should in general be designed in the principle of shared space. These roads often have small traffic volumes of individual motorized traffic. Long-term public parking contradicts the efficient and human centred design of space. Furthermore the permanent occupation of space for public long-term parking is not reflected by market prices. The potential of using public space in a human centred way is enormous. Especially children are occupying “their” space as soon as it is available. The precondition is the removal of parking spaces from the road space. “Space-time” is a good indicator which should be used to illustrate the enormous occupation of public space by cars over a time period. It makes obvious, that a more flexible allocation of space and new road designs are necessary that consider the needs of non-motorized traffic in a more appropriate way.

## References

- [1] Stadtentwicklung Wien, MA 18 – Stadtentwicklung und Stadtplanung: STEP 2025 – Fachkonzept Mobilität – miteinander mobil; Werkstattbericht 145; Wien, 2015.
- [2] Steierwald, G., Künne, H., Vogt, W.: Stadtverkehrsplanung: Grundlagen, Methoden, Ziele, Springer-Verlag. Wien, 2005.
- [3] Linder, F., Wüthrich, B.: Nahmobilität 2.0; Arbeitsgemeinschaft fahrradfreundliche Städte, Gemeinden und Kreise in Nordrhein-Westfalen e.V. (Hrsg.); Krefeld; 1.Auflage. 2012.
- [4] Magistrat der Stadt Wien, MA 23: Gendersensible Statistik: Lebensrealitäten sichtbar machen; Statistik Journal Wien 2/2014; p. 17, 2014.
- [5] Frey, H., Leth, U., Mayerthaler, A., Brezina, T.: Predicted congestions never occur. On the gap between transport modelling and human behaviour”; Transport Problems, Volume 6 (2011), Issue 1; S. 73 – 86. 2011.
- [6] Knoflacher, H.: Grundlagen der Verkehrs- und Siedlungsplanung. Siedlungsplanung. Böhlau Verlag, Wien, 2012.
- [7] <http://www.wien.gv.at/statistik/verkehr-wohnen/tabellen/verkehrsflaechen-rad-zr.html>
- [8] Knoflacher, H., Brunsch, St., Kölbl, R., Daschütz, P., Brezina, T.: Wienbild: Schein und Sein. Messbare Indikatoren zur Entwicklung und Zusammenhänge der Städte. Presentation: “Wien und seine Nachbarn. Das Potential und die Zukunft der Stadt Wien in Mitteleuropa”. Club of Vienna, Wien. 2003.
- [9] Pfaffenbichler, P. C.: “Verkehrsmittel und Strukturen.” Wissenschaft & Umwelt INTERDISZIPLINÄR(3): pp. 35-41, 2001.
- [10] Knoflacher, H.: Öffentliche Verkehrsmittel – Neue Strukturen zur Verbesserung ihrer Chancengleichheit im städtischen Raum. Internationales Verkehrswesen, 31.Jg.,3: pp. 176-178, 1980.
- [11] Heran, F.: La consommation d’espace-temps des divers modes de déplacement en milieu urbain Application au cas de l’Île de France. Rapport final. Programme national de recherche et d’innovation dans les transports terrestres. 2008
- [12] Marchand, L.: Un concept fécond, la consommation d’espace temps. Les cahiers scientifiques de la revue Transport, 2e semestre. 1984
- [13] Marchand, L.: Du bon usage de l’espace de voirie dans les centres urbains, ENPC, Cycle Transport de voyageurs. Module 2 : l’économie des transports, Paris, p. 11. 1993
- [14] Knoflacher, H.: Wer hat Vorfahrt im urbanen Raum? In: Der Nahverkehr 7-8/2015.



## THE NATIONAL TRANSPORT MODEL FOR THE REPUBLIC OF CROATIA – APPLICATION AND USE

Uwe Reiter<sup>1</sup>, Igor Majstorović<sup>2</sup>, Ana Olmeda Clemares<sup>3</sup>, Gregor Pretnar<sup>4</sup>

<sup>1</sup> PTV Transport Consult GmbH, Germany

<sup>2</sup> University of Zagreb, Faculty of Civil Engineering, Croatia

<sup>3</sup> INECO, Spain

<sup>4</sup> PNZ, Slovenia

### Abstract

The Croatian Ministry of Maritime Affairs, Transport and Infrastructure commissioned the development of the National Transport Model to a Consortium combining local national knowledge with international expertise. The scope of the project is to develop the National Transport Model, collect all available data, carry out necessary surveys, develop networks models and demand models for freight and passenger demand for the base year, calibrate and validate the models, and develop forecast models for the time horizons of 2020, 2030 and 2040. The purpose of this National Model is to identify shortcomings, bottlenecks and issues in the current and the planned future transport systems of Croatia. Furthermore, this model is the basis to identify and develop strategies to alleviate the shortcomings of the current transport system and to develop the future transport system in a direction of meeting future demand and of promoting the economic and social development of the Country without compromising its sustainability. The model is used to identify specific measures and projects for the different transport modes and their integration supporting the selected strategies. Both, the individual measures as well as the complete strategies will be tested with the National Model. The model will produce quantitative results allowing to determine impacts of the strategy alternatives and of the measures on traffic conditions, on social and environmental impacts. Consequently, the National Transport Model is a basic and important component for the development of the future National Transport Strategy, delivering the necessary quantitative basis for analyses and selection of alternatives. Furthermore, the National Transport Model forms the basis for the development of Regional and Urban Models, necessary for the respective Regional and Urban Master Plans. The availability of a high-quality National Model guarantees that similar approaches are used at the regional level, improving the general transport planning approaches all over the country.

*Keywords: Transport Model, Analysis of transport conditions, transport forecast, development of transport strategy, evaluation of impacts*

### 1 About the project

The National traffic model for the Republic of Croatia is co-financed by the EU from the European Regional Development Fund under Transport Operational Programme 2007–2013 within the project “Support for the preparation of the Republic of Croatia’s Transport Development Strategy and designing of the national Traffic Model for the Republic of Croatia – National Traffic Model for the Republic of Croatia”.

## 2 Introduction – purpose of a national transport model

The development of the National Transport Model for the Republic of Croatia was not an end in itself. The intention of the Croatian Ministry of Maritime Affairs, Transport and Infrastructure in commissioning the model development was to obtain a quantitative tool that could support the development of the National Transport Strategy, help to analyse current conditions and forecast future conditions, provide the basis to identify necessary strategies and measures and finally being able to calculate the impacts of strategies and measures on the future transport system and the influencing processes, like social, economic and environmental processes. A National Transport Model is the necessary tool to plan the sustainable development of the transport system.

## 3 Model development

The model was developed using the software suite PTV VISION (Visum and VisEVA). It follows the classical 4-step approach. However, it should be noted that the National Model of Croatia is a Synthetic Model using network data, socio-economic data and behavioural data as its foundation. Only a synthetic model, and of course a synthetic model calibrated and validated to actual empirical data, is capable of scientifically and correctly forecasting future developments and of calculating impacts of changes in influencing conditions (exogenous factors like economic and social development) and of changes within the transport system itself, e.g. implementation of strategies and measures (endogenous).

For passenger transport, a scientific trip generation model was developed for the resident population and for the visitors and guests of the country, information of the actual destinations of trips of residents and visitors was used for trip distribution. Similarly for freight transport, data on import/export, production, processing and consumption of numerous commodity types was used to develop the freight generation and distribution. For both models, mode choice and assignment were based on costs including actual travel times.

The socio-economic data was collected from different sources at the level of model zones mainly from National Statistics. The basis for the behavioural data was a household survey with more than 3,000 interviews and a survey of freight operators, both carried out within the project. Empirical data was complemented by traffic counts and public transport passenger counts. The empirical data from external sources and from the own surveys was used to calibrate and to validate the model. To represent differences between the summer season with high numbers of tourists visiting the country and the rest of the year, two different models were produced, an off-season model and a seasonal model.

Model development consisted in the development of a base year model and of forecast models for the horizon years 2020, 2030 and 2040. Forecast was based on the available and accepted official data of future socio-economic development of Croatia and the surrounding countries (EU Energy, Transport and GHG Emissions Trends to 2050 [3]). For all forecast horizon years, a so-called do-minimum scenario was developed that will be used as a reference scenario, including only those projects and measures that are already under development or that are planned and financed. The do-something or strategy scenarios will include additional projects and measures being part of the national transport strategy. Details of model development, calibration and validation are described in the other two papers of this conference, namely:

- The National Transport Model for the Republic of Croatia – Development of the Freight Demand Model [1]
- The National Transport Model for the Republic of Croatia – Development of the Passenger Demand Model [2]

## 4 Application and Use of the National Transport Model

After development, calibration and validation of the transport model, it can be used to assess current and future conditions, to identify potential strategies and measures to improve conditions and to assess the impacts of these strategies and measures on the transport system itself and on influenced processes, like environmental impacts, accessibility and social inclusion, social impacts and impacts on economic development.

### 4.1 Analysis of current conditions

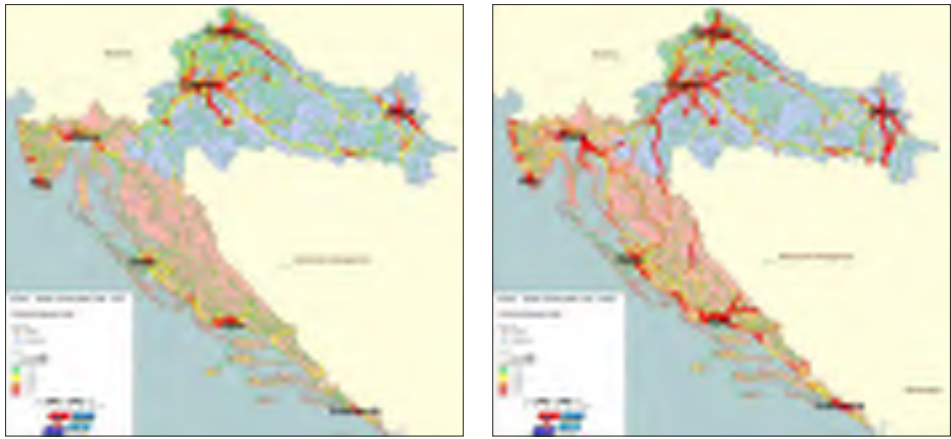
The model was used to analyse current conditions on the Croatian road network and on the National public transport system. Examples are described below. For road transport, the total vehicle flows in terms of Annual Average Daily Traffic (AADT) for the off-seasonal conditions and the Average Seasonal Daily Traffic (ASDT) are given in figure 1 in form of number of vehicles.



**Figure 1** Road traffic – Annual Average Daily Flow for whole Year (ADT) and for seasonal traffic (ASDT)

Of course the highest traffic flows can be observed on the motorway and trunk road networks from Zagreb to all parts of the country and around the larger metropolitan areas in Croatia, mainly Zagreb, Zadar, Rijeka, Split, Varaždin, Osijek and Dubrovnik. The traffic flow analysis is the basis for identifying the major OD relations in the country and to determine external impacts like environmental impacts emission of pollutants and noise.

For understanding the internal impacts and to identify bottlenecks in the network and potential shortcomings, it is necessary to relate the actual flows to the provided capacities. The figure 2 shows the volume/capacity ratio, again for the off-season conditions and the conditions within the summer season.



**Figure 2** Road Traffic – Volume/Capacity Ratio for Annual Average (ADT) and for seasonal traffic (ASDT)

Differences are clear; while in the off-season situation, high volume/capacity ratios can be observed mainly around the major cities, and here more in the continental cities of Croatia, in the summer season high volume/capacity conditions occur also on the motorway network towards the Adriatic coast and in and around the Adriatic cities. Levels above 75% volume/capacity ratio are critical, potentially bearing the risk of congestion and traffic breakdowns at peak hours.

To better understand what internal impacts high traffic flows have on the road users, the Visum transport model allows to display the so-called lost time. This is defined as the ratio between travel times at free flow conditions and the actual travel times at the actually calculated flow conditions. The lost time in form of the ratio current travel time / free flow travel time is shown in the figure 3 for annual average off-season and for seasonal conditions.



**Figure 3** Road Traffic – Lost time for off-season (ADT) and for season (ASDT)

Similar analyses can be carried out for public transport. The passenger flows are displayed in the left figure 4 for the 3 main modes of public transport rail, bus and ferry/boat. Capacity overexploitation and resulting lost times are usually not the problem in public transport. It is rather gaps in supply, service gaps or very long travel times particularly in comparison to other modes, mainly to the car. To display supply/ service quality, the figure 4 to the right shows

the accessibility of the city centres of the major cities from the whole territory of the country in 30 minute steps. This could also be compared to similar accessibility plots for car traffic. The accessibility analysis shows that there are service gaps between the cities, mainly between Zagreb and Zadar and Zagreb and Osijek, with very long access times or even no public transport at all. However, these are remote areas with low population densities. More graphical and quantitative analyses are possible and have been carried out for the current conditions represented in the base year model.



Figure 4 Public Transport – Flows (Assignment) and Accessibility of City Centres by Public Transport

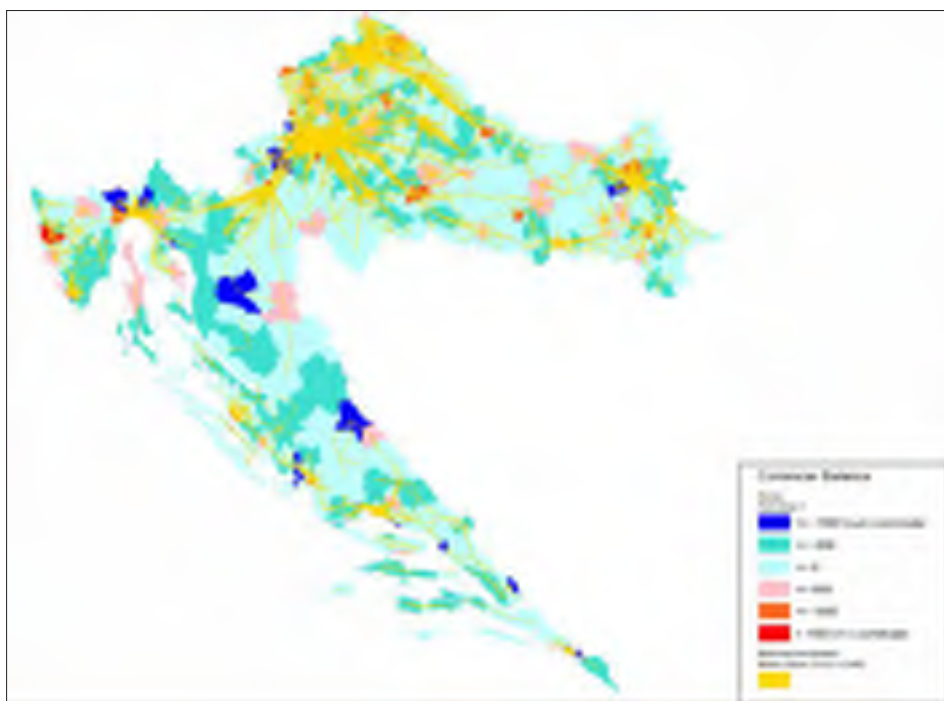


Figure 5 Display of Commuter Flows for the definition of Functional Regions



Model results can also be used for a more complex analysis, for example for defining so-called “Functional Regions”. Functional regions are areas with a high frequency of internal regional interaction. The concept of functional regions is used worldwide to understand and define functionally connected areas that need to administer the transport system across administrative borders. The most commonly approach to define functional regions is using data on population commuting to work and school because the pattern of daily commuting rule is a good approximation for staging other types of interaction. The National Transport Model has been used to determine commuter trips into and out of the major cities as a basis to define functional regions for Croatia (see figure 5).

#### 4.2 Analysis of future conditions

Since the National Transport Model of Croatia not only represents current conditions but was designed also for the forecast horizon years 2020, 2030 and 2040, the analyses can be carried out also for the future transport conditions. To identify future bottlenecks and shortcomings, a so-called do-minimum scenario is used. In the do-minimum scenario, future demand is calculated based in forecasts of socio-economic and behavioural development, whereas the transport networks represent current conditions only enhanced with those measures and projects that are already under construction now or are planned and fully financed. These do-minimum scenarios allow to evaluate how conditions will develop if no strategy is applied and are used as reference scenarios to the do-something scenarios, representing future strategy or strategy alternatives.

As an example the following 3 plots (figures 6, 7 and 8) show the development of road traffic volumes and the ratio of volumes/ capacity for the off-season conditions for 2020, 2030 and 2040. Obviously, all other graphical and quantitative analyses are also carried out for these 3 forecast horizon years.



**Figure 6** Forecast 2020; Do-Minimum Scenario; Off-Season; Road Network; Road traffic volumes and Volume / Capacity Ratio



**Figure 7** Forecast 2030; Do-Minimum Scenario; Off-Season; Road Network; Road traffic volumes and Volume / Capacity Ratio



**Figure 8** Forecast 2040; Do-Minimum Scenario; Off-Season; Road Network; Road traffic volumes and Volume / Capacity Ratio

The graphs clearly show that an increase in long-distance road traffic is calculated over the 3 time horizon years (width of the link bars), resulting in an increase of links with higher volume/capacity ratio (colour of the link bars), meaning deteriorating traffic flow conditions, if no strategies and measures are implemented, i.e. infrastructure capacity remaining unchanged and no demand policies applied.



### 4.3 Identification of strategies and measures

These analyses of current and forecasted future traffic conditions, accessibility and transport impacts are an important input to develop strategies and measures to alleviate the identified shortcomings and to transform the transport system in accordance with more general transport visions and objectives. The development of strategies and measures will normally be based on the overall Vision and the defined objectives of the National Transport System. Normally, these objectives will include:

- Ensure economic, social and environmental sustainability
- Provide accessibility and social inclusion
- Increase traffic safety
- Increase transport efficiency and quality of services
- Reduce negative impacts on the natural, man-made and social environment

Strategies will use a combination of the following

- Influence transport demand towards more sustainable modes, shorter travel distances etc.
- Optimise exploitation of provided transport capacities (increase vehicle occupancies, temporal optimisation like peak spreading, technical increase of capacities through transport telematics/ ITS)
- Expand and improve network capacities through new links and more services, enlarged links and improved junctions

Based on objectives and strategies and on the findings about current and future traffic conditions, measures will be developed that belong to the following types:

- Policy measures, like speed limits, vehicle access restrictions, information measures, parking policies and others
- Infrastructure measures: new links, new junctions
- Financial measures: pricing of car use (e.g. fuel prices, taxes), road use (tolls), parking (fees), pricing of public transport (fares)

As the National Transport Strategy for Croatia is currently under development by the Ministry and the Strategy Development team, no final results can be given at this stage. The preliminary list of measures includes improvements of capacities and travel speeds on the rail network (corridor Zagreb – Karlovac – Rijeka, Zagreb – Hungarian State border, Zagreb – Serbian State border), the road network (mainly motorway extensions to the border with neighbouring States) and capacity and accessibility developments for a number of ports and improvements to road traffic regulations.

### 4.4 Assessment of impacts of strategies and measures

At the time of writing this paper, the strategy and the measures developed by the Transport Strategy Team of the Ministry are still preliminary and the modelling team can only start representing these in the model in form of a do-something scenario. This process will most likely be finalised by the time of the conference and results of the impact analyses might potentially be presented at the conference.

In any case, the impact assessment will include the type of analyses described above for the base year and the do-minimum forecast year scenarios. Besides these evaluations, of course the differences between the strategy alternatives (do something) and the reference case (do minimum) will be calculated, displayed and processed.

This will form the basis for the impact assessment, for cost-benefit and multi-criteria analyses of the Strategy alternatives and the included measures.

#### 4.5 Development of a National Transport Strategy

As a result of the assessments and analyses of the strategy alternatives and the impact assessment of the individual measures, a National Transport Strategy will then be developed, combining the most suitable strategy options and most effective measures.

The final assessment of this National Transport Strategy can then again be based on the results of the National Transport Model.

### 5 Development of regional and urban transport models

Numerous regional and urban transport and mobility master plans are now under development throughout Croatia. All regions and metropolitan areas are carrying out these master plans. One important component of these regional and urban master plans is the quantitative analysis of current and forecasted conditions and the impact assessment of proposed measures and changes. Regional and urban transports model are needed for these exercises. The National Transport Model forms the basis for the development of these models representing smaller areas.

Technically, the National Model can be used to extract so-called sub-network models, then forming the basis for the implementation of further details, like more detailed zoning structure in the respective area of interest, more detailed allocation of socio-economic data based on the refined transport zones, adding details to the road network and adding local public transport lines and services.

It is important that the general structure remains in line with the National Model for consistency and plausibility reasons, e.g. the assumptions of socio-economic developments over the forecast horizon years. After finalisation of regional and urban master plan studies, local and regional improvements to the models can be fed back to the National Transport Model.

### 6 Conclusion

The Ministry of Maritime Affairs, Transport and Infrastructure has commissioned the development of the National Transport Model in preparation of the development of the National Strategy. The consultant team have finalised the main work on developing this powerful tool in form of a synthetic 4-step model, by developing the base year model with network model, passenger and freight demand models, have calibrated this model with survey data and have validated it against empirical data. The result is a robust model capable of forecasting future transport conditions and calculating impacts of exogenous changes (like political and socio-economic conditions) and endogenous changes in form of transport strategies and measures. The model is now available to test and assess the strategy alternatives and to assist in developing the National Transport Strategy for the Republic of Croatia.

### References

- [1] Landmann, J., Thomas, A., Majstorović, I., Pretnar, G.: The National Transport Model for the Republic of Croatia – Development of the Freight Demand Model, CETRA 2016.
- [2] Pretnar, G., Trošt, D., Majstorović, I., Landmann, J., Thomas, A.: The National Transport Model for the Republic of Croatia – Development of the Passenger Demand Model, CETRA 2016.
- [3] European Commission – Directorates General for Energy, for Climate Action and for Mobility and Transport, EU Energy, Transport and GHG Emissions – Trends to 2050, ISBN 978-92-79-33728-4, 2013.





## THE NATIONAL TRANSPORT MODEL FOR THE REPUBLIC OF CROATIA – DEVELOPMENT OF THE FREIGHT DEMAND MODEL

Jens Landmann<sup>1</sup>, Andree Thomas<sup>1</sup>, Igor Majstorovič<sup>2</sup>, Gregor Pretnar<sup>3</sup>

<sup>1</sup> PTV Transport Consult GmbH, Germany

<sup>2</sup> University of Zagreb, Faculty of Civil Engineering, Croatia

<sup>3</sup> PNZ, Slovenia

### Abstract

National transport model of Croatia (NTMC) consists of network, demand and assignment submodels. Whilst network model (nodes, links, zones) is common, approaches for demand and assignment differ between passenger and freight transport. Each type of transport requires specific methods. This paper describes development of the freight demand model, namely its input data, modelling methods, calibration and validation.

The main inputs for modelling of freight transport are socioeconomic data and national statistics on production and trade flows (import / export). Socioeconomic data was collected on the zoning level. For production and import / export, the statistical data was available at national level and was broken down to zoning level according to the socioeconomic data of each zone. Main source for socioeconomic data (population, employment, working places by economic sector) were national statistics (Croatian Bureau of Statistics). Sources for production data depend of the type of commodity, while import / export data was derived from the national trade statistics. The freight demand model considers all transport modes relevant from a national perspective, i.e. road (HGV and LGV), rail and vessel. The modal freight trip matrices are calculated with a commodity based multi-modal model using an enhanced 4-step approach. For the adequate consideration of commodity-specific affinities, the freight traffic is segmented into 50 different commodities; each of them having specific generation and attraction rates as well as specific modal transport cost rates. The calculation steps of the enhanced 4-step approach are conducted separately for each commodity. The multi-modal freight model, which mainly generates the long-distance trips, is supplemented by a sub-model for generating the freight trips from / to the airports and by a sub-model for the local (short-distance) distribution trips by HGV and LGV.

*Keywords: transport model, freight demand model, calibration, validation*

### 1 About the project

The National traffic model for the Republic of Croatia is co-financed by the EU from the European Regional Development Fund under Transport Operational Programme 2007–2013 within the project “Support for the preparation of the Republic of Croatia’s Transport Development Strategy and designing of the national Traffic Model for the Republic of Croatia – National Traffic Model for the Republic of Croatia”.

## 2 Introduction

The Croatian Ministry of Maritime Affairs, Transport and Infrastructure commissioned the development of the National Transport Model to a Consortium combining local national knowledge with international expertise. The National Transport Model comprises both, a transport demand model for the passenger traffic and a transport demand model for the freight traffic. National transport model of Croatia (NTMC) has been developed for the base year first. After calibration and validation of the base year, forecast models for the time horizons of 2020, 2030 and 2040 have been developed. NTMC consists of network, demand and assignment submodels. Whilst network model (nodes, links, zones) is common, approaches for demand and assignment differ between passenger and freight transport. Each type of transport requires specific methods. This paper describes the development of the freight demand model, namely its input data, modelling methods, calibration and validation and model results.

## 3 Freight demand model

Freight transport as a whole is a very complex and heterogeneous process. The multi-modal freight model follows a highly disaggregated approach to calculate the freight volumes based on origins and destinations of homogenous commodity types. This includes both, domestic freight flows and external freight flows (import/ export/ transit). The freight model considers all transport modes relevant from a national perspective, i.e. road (HGV and LGV), rail and vessel. The same network as for the passenger model is used, enhanced with additional mode-specific freight parameters and transshipment infrastructure for intermodal handling of goods.

### 3.1 Approach

The modal freight trip matrices are calculated with a commodity based multi-modal model using an enhanced 4-step approach. As a big advantage of this synthetic multi-modal approach, the proposed methodology guarantees:

- the adequate consideration of commodity-specific affinities regarding different transport modes,
- the ability to reflect multi-modal transport and inter-modal transport chains,
- a realistic calculation of future freight demand based on socio-economic changes and/ or network modifications (e.g. new links or transshipment hubs),
- the consideration of all possible transportation modes for route choice.

Figure 1 shows the calculation steps, which are applied for the multi-modal freight model calculations. These steps are calculated separately for each commodity to consider their specific characteristics regarding freight generation, distribution, mode choice and assignment. The different commodity types, which are considered, range from agricultural goods (e.g. cereals, fruits, vegetables), raw materials (e.g. coal, raw wood, ores), oil products, industrial products (e.g. steel and metal products, chemical products) to construction materials and consumer goods.



Figure 1 Freight Model Calculation Steps

### Freight Generation

In practice, the reasons for the transport of goods are the different locations of production and consumption of a certain good and the resulting need of exchange. Hence, as a first step of the demand calculation, the generated volumes per traffic zone are determined for each commodity. This is done both for the production side (also referred to as origin side) and the consumption side (also referred to as destination side). In general, the determination of origin and destination vectors is conducted in 2 steps:

- 1) Determine production and consumption volumes on national level for Croatia and the countries of the region
- 2) Break down of these national volumes to traffic zone level

On national level, there is the constraint that the total generated volume of all origin zones must equal the total generated volume of all destination zones. While the origin volumes consist of local production volumes and import volumes, destination volumes are the sum of local consumption and export.

$$\sum_i \text{FreightVolumes}_o = \sum_j \text{FreightVolumes}_d \quad (1)$$

$$\sum_i (\text{Local Production} + \text{Import}) = \sum_j (\text{Local Consumption} + \text{Export}) \quad (2)$$

Where:

- O; D – origin; destination;
- i – index for origin traffic zone;
- j – index for destination traffic zone.

The production and consumption volumes on national level are broken down to traffic zone level by the distribution of the decisive land uses for each commodity. Depending on the type of commodity, decisive land uses can be for example population, employees by economic sector as well output/ production capacities of production facilities. Thus, calculating the local production and consumption per zone and adding the import/ export volumes, for each commodity two vectors are generated. One includes the generated origin volumes per zone, the other vector the attracted destination volumes.

### Freight Distribution

Like traffic generation, distribution calculation is applied successively and separately for each commodity. Using a gravity model, the generated origin and destination volumes per zone are distributed, resulting in yearly ton flows between the traffic zones. The trip distribution calculation is carried out in 2 steps:

- 1) Calculation of evaluation matrix based on a skim matrix including the impedances between traffic zones
- 2) Calculation of trip matrix (yearly ton flows) based on the evaluation matrix and the origin and destination volumes

A monetary impedance matrix calculated from the VISUM network model is used as skim matrix. The matrix values in [€] are calculated with the following impedance function.

$$w_{ij} = \sum C_{\text{handling}} + \sum (\text{Length} \cdot c_{\text{km}}) + \sum (\text{Time} \cdot c_h) \quad (3)$$

where:

- $w_{ij}$  – impedance between traffic zone i and traffic zone j [€];
- $C_{\text{handling}}$  – handling costs [€];
- $c_{\text{km}}$  – distance cost rate [€/km];
- $c_h$  – time cost rate [€/h].

For all commodities, different impedances (costs) result from:

- different cost rates for required logistic system (e.g. bulk, container) and
- different requirements for transport speeds due to varying urgencies (loss of value)

### Mode Choice

The route and mode choice are conducted simultaneously in an interim assignment step for the ton flows. The ton flow matrices of each commodity are assigned to the multi-modal network with an equilibrium assignment procedure.

The mode choice decision for a certain commodity and origin-destination relation is based on the transport costs. It is always the most cost efficient route and transport mode that is chosen. This can be either a direct transport with one transport system or a multimodal chain with a combination of transport modes and transshipments in between. As illustrated in Figure 2, the total transport costs, which are the determining factors for the route and mode choice during the assignment, consist of:

- Time costs (mode specific time costs + commodity specific loss in value)
- Distance costs (mode specific distance related transport costs)
- Handling costs (costs for loading/ unloading and transshipment)

The modal transport costs are allocated to all network links. Different sets of transport costs consider:

- The link attributes (permitted transport mode; transfer link) and
- The logistic system, the commodity is allocated to

As noted before, the ton flow matrices of each commodity are assigned to the multi-modal network with an iterative equilibrium assigning procedure, resulting in the most cost-efficient route and mode choice for each OD relation. From the multi-modal ton flow assignment, ton flow matrices by mode can be derived.

### Conversion to vehicle trips and vehicle assignment

The modal ton flow matrices are converted to vehicle trip matrices by average loading factors (depending on distance classes) and a factor for the unloaded drives. Finally, the generated HGV and LGV trip matrices are assigned to the PTV Visum network together with the trip matrices from the passenger demand model.

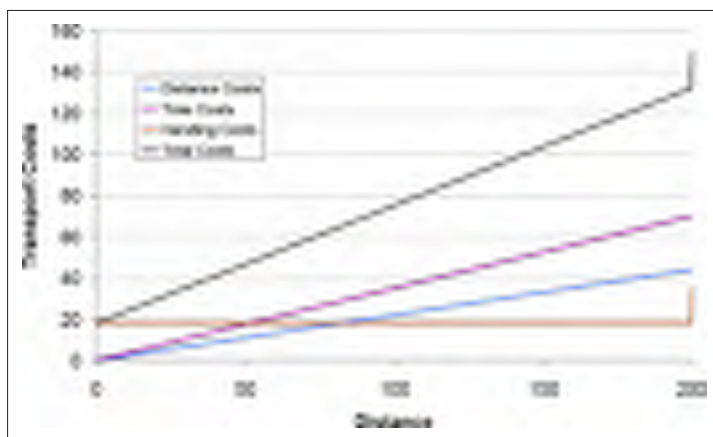


Figure 2 Composition of total transport costs

## 3.2 Input Data

The main input data of the freight demand model is listed below:

- Socio-economic data, i.e. population and employment data, disaggregated to traffic zone level,
- Data on national production (production volumes, location of major production facilities) for each commodity,
- Import / export data from trade statistics, aggregated to about 50 freight model commodities,
- Transit data from UN COMTRADE statistics in, aggregated to the freight model commodities,
- Transport cost parameters (distance related; time related; transshipment costs) per transport mode for the route and mode choice calculation,
- Operational parameters (e.g. average loading factors and share of empty trips by commodity and vehicle type),
- Growth rates and macro-economic parameters are required for forecasting internal and external freight flows.

## 4 Results

The main results of the multi-modal freight model are summarized below:

- Generated and attracted volumes per commodity and traffic zone in tonnes per year (see Figure 3),
- Yearly ton flow matrices by transport mode (rail, road, ship),
- Daily trip matrices (HGV, LGV),
- Link volumes in tonnes per year (see Figure 4) and HGV / LGV trips per day.



#### 4.1 Base Year Results



Figure 3 Production / attraction volumes per zone for each commodity



Figure 4 Link volumes by transport mode in tonnes per year

#### 4.2 Model calibration and validation

reliability and credibility are the key characteristics of good and useful transport models. The necessary precision of the model is achieved by the calibration, whilst the reliability and credibility required are proven by the validation.

Validation procedure for the verification of the adequacy of the national transport model of Croatia (NTMC) is based on internationally recognized guidelines:

- JASPERS Appraisal Guidance (Transport) [1]
- Design Manual for Roads and Bridges, Volume 12 [2]
- Variable Demand Modelling – Convergence Realism and Sensitivity [3]

Critical opinions on these documents and examples of good practice have also been taken into account. Considering all above mentioned guidelines and recommendations the following validation criteria have been settled:

- $R^2 > 0.9$
- 65% of GEH  $< 5$
- 85% of GEH  $< 10$

For the freight model, the calibration and validation process comprises three levels:

- total national freight volumes by mode [tonnes]
- port and border crossing volumes [tonnes]
- freight vehicle volumes at 480 count locations

For all validation levels, a satisfying model quality is achieved. Figure 5 presents the correlation between observed and modelled HGV volumes at the count locations. The correlation factor  $R^2$  is 0.92 and 95 percent of the count locations have a GEH  $< 5$ .

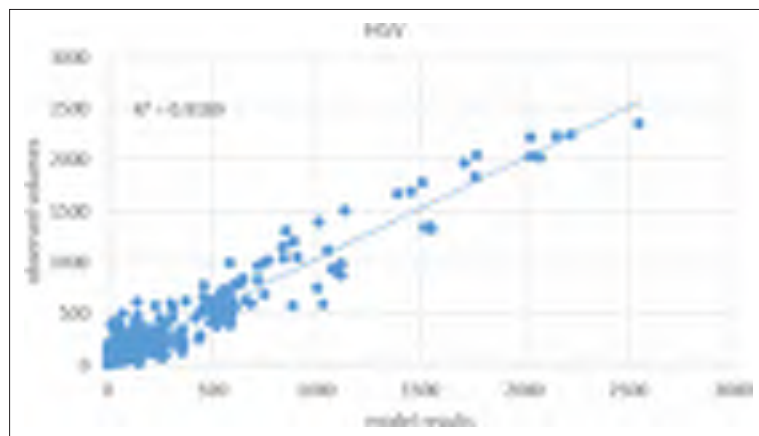


Figure 5 Correlation between observed and modelled HGV volumes

### 4.3 Forecast results

currently, the reference scenarios for the forecast horizon years 2020, 2030 and 2040 have been finalized.

Forecasting political and (macro-) economic developments, in turn effecting production, consumption and hence transport, were beyond the scope of the NTMC study. Therefore, established growth factors published in several EU studies were used to calculate the expected freight flows for the respective forecast horizons.

The do-something scenarios are under development. From the results of the reference scenarios, the total development of import, export and transit traffic by commodity groups can be analysed as presented in Figure 6.



Figure 6 Comparison of import, export and transit volumes by commodity group between base year 2013 and forecast horizon years

References

- [1] Jaspers: JASPERS Appraisal Guidance (Transport) – The Use of Transport Models in Transport Planning and Project Appraisal, 2014.
- [2] Highways Agency: Design Manual for Roads and Bridges, Volume 12, 1997.
- [3] Department for Transport: TAG UNIT M2 – Variable Demand Modelling – Convergence Realism and Sensitivity, 2014.
- [4] NTM Croatia Consortium: NTM Croatia Model Development Report, 2016.



## THE NATIONAL TRANSPORT MODEL FOR THE REPUBLIC OF CROATIA – DEVELOPMENT OF THE PASSENGER DEMAND MODEL

Gregor Pretnar<sup>1</sup>, David Trošt, Igor Majstorović<sup>2</sup>, Jens Landmann<sup>3</sup>, Andree Thomas<sup>3</sup>

<sup>1</sup> PNZ, Slovenia

<sup>2</sup> University of Zagreb, Faculty of Civil Engineering, Croatia

<sup>3</sup> PTV Transport Consult GmbH, Germany

### Abstract

The Croatian Ministry of Maritime Affairs, Transport and Infrastructure commissioned the development of the National Transport Model to a Consortium combining local national knowledge with international expertise. The scope of the project is to develop the National Transport Model, collect all available data, carry out necessary surveys, develop networks models and demand models for freight and passenger demand for the base year, calibrate and validate the models, and develop forecast models for the time horizons of 2020, 2030 and 2040. This paper describes development of passenger demand model, including methodology, data collection and validation. Passenger demand model is an integral part of National Transport model that consists of common network with common zoning, passenger and freight demand models and assignment.

*Keywords: Transport Model, Household survey, Origin-Destination Groups, Synthetic model*

### 1 About the project

The National traffic model for the Republic of Croatia is co-financed by the EU from the European Regional Development Fund under Transport Operational Programme 2007–2013 within the project “Support for the preparation of the Republic of Croatia’s Transport Development Strategy and designing of the national Traffic Model for the Republic of Croatia – National Traffic Model for the Republic of Croatia”.

### 2 Introduction – role of passenger demand model within a national transport model

There are several types and levels of transport models. Strategic are wider and more global, particularly suitable for strategic studies. They include in particular a direct correlation between urbanistic, socioeconomic and traffic conditions, and also between the elements of the transport system itself. This applies to so-called synthetic transport models. They cover very large, usually at least partially simplified, networks. National transport model for Republic of Croatia consists of passenger and freight models and is of strategic nature. While the network and zoning is equal, methodology differs between passenger and freight model. Basic model-based units are trip purposes for the passenger transport and types of vehicles as well as types of cargo for the freight (commodities). The results are presented in the “average workday traffic” unit in season and off-season, from which also the peak hour is developed.

Details of applications of national transport model and freight demand model are described in the other two papers of this conference, namely

- The National Transport Model for the Republic of Croatia – Application and Use [1]
- The National Transport Model for the Republic of Croatia – Development of the Freight Demand Model [2]

### 3 Model development

Passenger demand model consist of first three steps in traditional four-step model (Figure 1):

- generation (production and attraction),
- distribution and
- modal split.

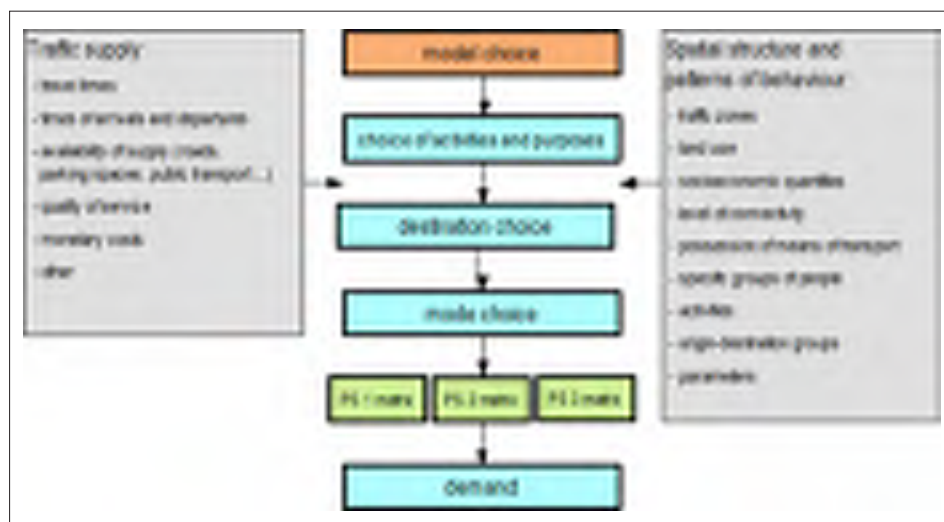


Figure 1 Structure of passenger demand model

Production and attraction primarily depend on the gross domestic product, motorization rate and spatial socioeconomic structure as well as of behaviour patterns, whilst attraction also partly of the traffic supply. Distribution approximately equally depends on the spatial socioeconomic structure and behaviour patterns on one hand and on the traffic supply on the other. Modal split particularly depends on the traffic supply and to a considerable extent also on the spatial structure. Last step is assignment of demand on the multimodal network. Static stochastic learning procedure (Lohse) is used. Public transport is assigned by the intermodal method based on timetables. Both, internal and external transport, are assigned simultaneously.

#### 3.1 Methodology

This approach enables that the forecast calculation considers changes in spatial structure, gross domestic product, motorization rate, residents, jobs, etc., as well as transport supply while calibrated parameters of the model remain unchanged.

Production and attraction were calculated by the method of origin-destination groups (13 origin-destination groups were considered for passenger transport). These 13 origin-destination groups actually represent 5 trip purposes (work, school, shopping, leisure and vacation, other) in conjunction with the location of residence and combinations between them. The trip purpose of business was specifically modelled.

From the household survey (performed within the project itself and described in 3.3) it was found that different parts of Croatia have different travel behaviour patterns. Therefore, the model of passenger transport production and attraction on the average workday was specially developed for Continental and Adriatic regions of the country. For each of the thirteen origin-destination groups a mobility rate (number of trips per day per person concerned) was determined. In most of these groups, the person concerned is a resident. However, in groups home-work, work-home, work-other and other-work, the concerned person is an employee, or in school trips, the person concerned is a pupil, secondary school or university student. Based on surveys across households in Republic of Croatia certain mobility rates were determined for all origin-destination groups. Development of the seasonal traffic was based on the same basis as the average workday model.

Thirteen origin-destination groups were taken into account to calculate the generation of passenger traffic, but the destination groups home-school and school-home were replaced by the destination groups home-vacation and vacation-home. Modified destination groups include trips from home to holiday and private facilities intended for vacation use (home-vacation) and trips in the opposite direction (vacation-home); there are no school trips during the holidays. Therefore, the purpose of (daily) leisure was extended for a special holiday subcategory of leisure (vacation). Distribution and modal split were calculated simultaneously. That is to say, at the same time the destination and the transport mode by which the trip is done were chosen. The calculation was carried out on the basis of the EVA probability function, for the average workday traffic and for the traffic during the tourist season. Input data for the distribution and modal split sub-model were:

- productions and attractions,
- generalized prices or generalized times for the road motorized and public transport,
- EVA model parameters.

Basic parameters of the model were set based on the stated researches, recommendations of the software manufacturer and previous experiences in modelling of the national and regional models. Based on these data and the EVA functions, within the multiple iterations, the trip matrices for passenger car transport, public transport, cycling and walking were calculated. Road assignment was carried out in several iterations. Based on the information obtained in the previous iteration, users find a new optimal route in the next iteration. Therefore, in the iterative process search for optimal route runs until the network equilibrium and the appropriate impedance matrix convergence were reached. Network assignment was based on the function of generalized price or generalized time. In seeking the optimal routes, also the effects of traffic congestions and jams were taken into account, i.e., the effects of driving speed reductions. BPR function was used for this, the most common volume-delay function, which reflects the travel time, depending on the volume and road capacity. It was useful both for modelling of non-urban and urban roads. Toll was incorporated through the function of generalized time, where the monetary values were converted into the equivalent of time.

Different free flow speeds were considered for freight transport than for personal transport, because also in free traffic flow the freight vehicles must not drive faster than allowed. Inter-modal method for public transport assignment allowed the entire public transport network to operate as an unified system that includes rail, bus and maritime lines of various levels. The method, based on timetables, requires precise arrival and departure times of vehicles or trains at stations and stops to be set for all public transport lines. The network was therefore modelled in that way. For each origin-destination pair of zones a favourable connection was found or calculated. It was assumed that passengers are aware of the timetable, and will take the first available line of public transport offering a favourable route. Among various combinations of routes, more favourable routes were chosen. The most favourable routes were determined on the basis of the whole chain of route segments, including ticket price, which was included in the function of generalized time.



### 3.2 Network and zoning

The network system was composed of road and rail systems, airports, maritime and inland ports. The national and international connections were mainly established by primary road network (motorways, trunk roads and state roads), railway network and ports, Figure 2. In addition, roads in major urban areas have relevant functions for the national network and a significant impact on connectivity and accessibility. These network elements also serve as public transport routes and as alternative routes. Therefore, urban main roads were also included in road network. As result the following network elements were included in the model:

- Road network with all relevant levels (motorways; state, county, local and urban roads) with design standard and condition characteristics;
- Railway lines of importance to international, regional and local transport with design standard, traction, gauge, interoperability, conditions – restrictions and reliability characteristics, strategic national and international connections, capacity utilization, rolling stock, operators and safety;
- Public transport routes for rail, boat (ferry), tram, city and intercity bus lines with itineraries and rolling stock;
- Seaports (Rijeka, Zadar, Šibenik, Split, Ploče and Dubrovnik) with their characteristics, purpose and capacities;
- Inland ports (Sisak, Slavonski Brod, Osijek and Vukovar) with their characteristics
- Airports (Zagreb, Split, Zadar, Dubrovnik, Pula, Rijeka and Osijek), for which the land-side traffic will be modelled (by car, public transport and freight traffic);
- Intermodal facilities for passenger and freight transport.

Republic Croatia was divided into 985 traffic zones. Basic level for zoning were cities and municipalities. Traffic zones with population greater than 8.000 persons were brake down to lower level of territorial unit, i.e. city and municipality to settlement, settlement to statistical circle.



Figure 2 Road and rail network

### 3.3 Input data

The main input data of the passenger model is listed below:

- Transport network data for all modes (road, public transport),
- Socio-economic data, i.e. population and employment data, disaggregated to traffic zone level,
- Behavioural data from household survey (n=3.000),
- Transport cost parameters (distance related, time related, toll costs) per transport mode.

## 4 Model validation

In modern society the transport model represents one of the key bases for decision-making on transport and spatial policy, on the investments in the infrastructure demanding time and funds, on the form and dimensions of roads and railways, their impacts, etc. It is therefore important that the model results are reliable.

Reliability and credibility are the key characteristics of good and useful transport models. The necessary precision of the model is achieved by the calibration, whilst the reliability and credibility required are proved by the validation.

The growing role of the transport policy has initiated that transport models are becoming increasingly complex. Validation became an obligatory part of a model and the only way to justify its quality. Increasing complexity of models also led to greater complexity of the validation procedures. Validation procedure for the verification of the adequacy of the National traffic model for the Republic of Croatia (NTMC) was based on following documents:

- JASPERS Appraisal Guidance (Transport) The Use of Transport Models in Transport Planning and Project Appraisal, August 2014
- Design Manual for Roads and Bridges, Volume 12, 1997.
- Variable Demand Modelling – Convergence Realism and Sensitivity, TAG Unit 3.10.4, 2010.

Critical opinions on these documents and examples of good practice have also been taken into account.

### 4.1 Demand validation

Validation criteria for demand is less standardized than for validation of the assignment. Mostly due to lack of independent statistical data (as it is case with traffic counts and assignment). Nevertheless few quantitative and qualitative tests were done to prove the model. First step was checking the input data for demand that are socioeconomic and behavioural data. Socioeconomic data (number of population, workplaces, school places...) were taken from the official databases where they have already been submitted to various checks and should be reliable. There were some issues that required additional analyses (e.g. number of workplaces assigned to company's seat, no data available on shopping areas...).

Results of household survey were compared with existing data from previous studies and practice. It was established that most important indicators lie within expected benchmark values (e.g. between 2.5-3 daily trips per person, cca. 40% of work and school trips, characteristic morning and afternoon peak hours, average trip length and duration...).

First actual calculation for validation was done for trip duration distribution. Although such distribution is also input data, it serves also for checking results of the model. Modelled distribution is not only direct result from the survey, but also considers impedance (travel time, length...) between all pairs of zones, Figure 3.



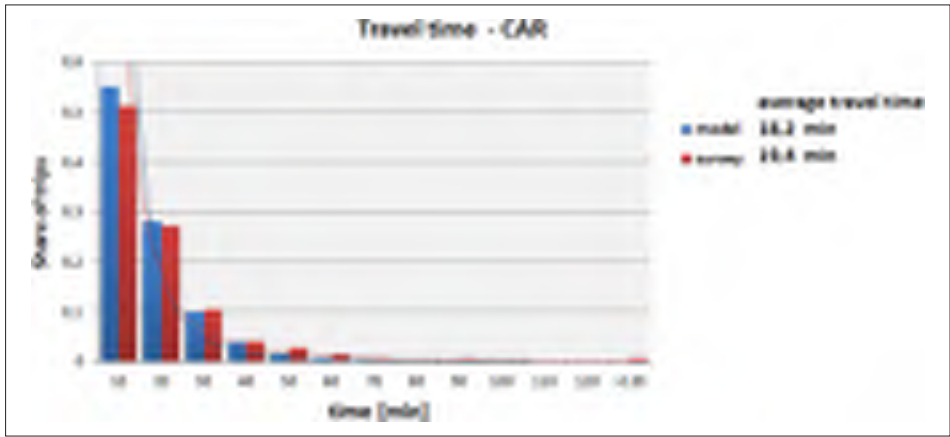


Figure 3 Validation of travel times distributions

### 4.2 Transport flow validation

Most traditional type of validation is validation of transport flows, Figure 4. Considering mentioned guidelines and recommendations we suggested following criteria to be accepted by the client for NTMC:

- $R^2 > 0,9$
- 65% of GEH  $< 5$
- 85% of GEH  $< 10$
- difference in transport work  $< 3\%$

In the table 1 and figure 5 goodness of fit is presented.

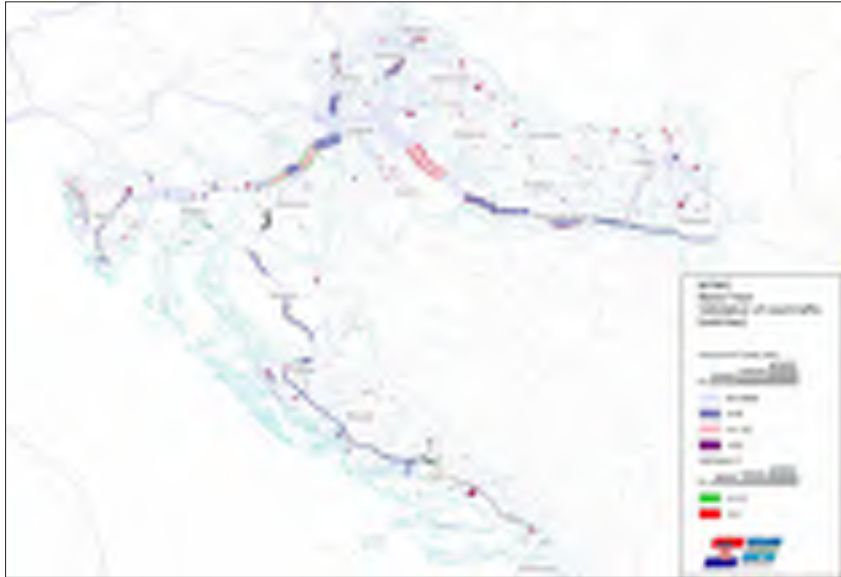
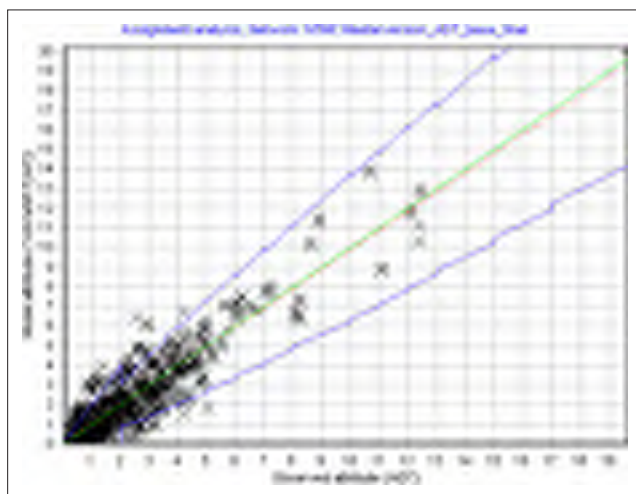


Figure 4 Validation of link volumes

**Table 1** Goodness of fit

	correlation	GEH < 5	GEH < 10	difference [veh*km]
offseason weekday	0,94	67%	88%	< 1%
offseason peak hour	0,91	65%	91%	< 1%
season weekend	0,96	70%	82%	< 3%
season peak hour	0,92	61%	84%	< 1%



**Figure 5** Correlation between observed and modelled car flows (weekday in off-season)

Only two indicators do not match expected criteria, but this is for season traffic, where input data were less reliable (no household survey, data about overnight stays, count data). With the use of matrix estimation for internal (Croatian) traffic numerical results would be much better and would fit all criteria. We do not encourage it, as this would decrease quality of forecasting models.

### 4.3 Realism test

If a model adequately reproduces the existing situation, it does not yet mean that it is appropriate for traffic forecasts. The demand model should also behave realistically. A change in the traffic supply should lead to a realistic change in the demand. A change in the demand should be consistent with general experiences. A change in travel time or trip price (cost in one word) particularly affects the mode choice and trip distribution. This impact must be in realistic limits. Acceptability of the model response is determined by the elasticity of demand. The equation of arc elasticity is as follows:

$$e = (\log (T1) - \log (To)) / (\log(C1) - \log (Co)) \tag{1}$$

where:

- e – elasticity;
- T1 – demand after change;
- To – demand before change;
- C1 – changed travel cost;
- Co – original travel cost.

Recommended elasticities for 20% changes in costs are presented in Table 2. According to the WebTAG recommendations, the elasticity on travel time must be significantly greater than on monetary costs, but not greater than -2.0. This means that a change in travel time has a significantly greater impact on the demand than a change in monetary cost. However, also the latter influences to some extent. But with the increasing value of time, travel time gains importance, whilst the impact of direct monetary costs decreases.

**Table 2** Recommended elasticities of demand to a change in supply

mode	travel time change	recommended elasticity	result [change in car]	result [change in public transport]
car	± 20%	κ - 2,0 <sup>[4]</sup>	-0,29 to -0,38	0,58-0,66
public transport	± 20%		0,28-0,35	-1,42 to -1,66

Sensitivity of the model must be within the recommended limits. For passenger cars the sensitivity is tested to a 20-percent change in travel time. Sensitivity for cars is between 0,29 and 0,38. This is consistent with the WebTAG recommendations. For public transport the sensitivity is also tested to a change in travel time. Sensitivity to the change in travel time is greater than for passenger cars and is 1,42 to 1,66, but still well within benchmark. Elasticity is negative in all cases. It means that the reduction of travel time results in more trips, whilst the extension of travel time causes fewer trips. Based on the sensitivity analysis we concluded that the model responds realistically on systemic and developmental changes and is therefore suitable to offer realistic traffic predictions. This test demonstrates an ability for a real change in modal split.

## 5 Limitations, applications and further use

Advantages of having validated complex national transport model are explained in the paper “The National Transport Model for the Republic of Croatia – Application and Use” [1] of this Conference. It is only fair that the developers of such powerful tool point out also its limitations. As it was mentioned in the second chapter, National traffic model for the Republic of Croatia is strategic model and as such particularly suitable for strategic studies. This also means that it is not automatically suitable for all kind of transport studies. Although there are 985 traffic zones in Croatia, such strategic zoning cannot provide accurate and reliable results for e.g. municipal bypasses, local public transport, tertiary roads, specific junctions... Second aspect of national model is that behavioural data observed with household survey are reliable on the distinction between Continental and Adriatic Croatia (e.g. specific differences between Istria and Dalmatia or between Karlovac and Osijek are not represented in the survey results). Another consequence of probabilistic methods used in national transport model is that trips with very low probability (established in surveys) are sometimes calculated as zero values. This of course affect only specific (less frequented) sections and does not influence model results on strategic level. All mentioned shortcomings can be vastly improved by further development of the model where we would suggest:

- development of regional models where national model serves as methodological foundations and basis of interregional/international flows
- additional household surveys on level of regions, municipalities using same/similar methodology (this would enable further refinement of next versions of national transport model as well)
- specific modal survey especially on public transport in order to gain better insight in its specifics.

Part of the project is also development of maintenance process which should serve as starting point for further activities wit national transport model.

## 6 Conclusion

Passenger demand model is an integral part of the National traffic model for the Republic of Croatia, commissioned by The Ministry of Maritime Affairs, Transport and Infrastructure. During project duration socioeconomic data were collected and analysed, household survey executed, model developed and in final step validated. The result is a powerful tool that needs to be used according to professional rules.

## References

- [1] Reiter U., Majstorović, I., Olmeda Clemares A., Pretnar G.: The National Transport Model for the Republic of Croatia – Application and Use, CETRA 2016.
- [2] Landmann, J., Thomas, A., Majstorović, I., Pretnar, G.: The National Transport Model for the Republic of Croatia – Development of the Freight Demand Model, CETRA 2016.
- [3] European Commission – Directorates General for Energy, for Climate Action and for Mobility and Transport, EU Energy, Transport and GHG Emissions – Trends to 2050, ISBN 978-92-79-33728-4, 2013.
- [4] WebTAG Tag Unit M2 Variable Demand Modelling – Convergence Realism and Sensitivity, 2014





## INITIATIVE FOR DEVELOPMENT OF SUSTAINABLE MULTIMODAL TRANSPORT AND MOBILITY NETWORK IN THE ADRIATIC-IONIAN REGION

Saša Džumhur, Enes Čovrk

*IPSA Institut d.o.o. Sarajevo, Bosnia and Herzegovina*

### Abstract

Sustainable development, infrastructure integration and competitiveness improvement efforts reflected through the EU transnational cooperation programmes have produced considerable results over the past decades. That is one of the reasons why the Members of the Adriatic Ionian Council (AIC), are convinced that the EU Strategy for the Adriatic and Ionian Region (EUSAIR) will give new impetus to the benefit of all involved. Effective investment in transport networks requires innovative approaches, linked to up-to-date research. One of expected outputs from the 2nd EUSAIR thematic pillar: Connecting the Region is to improve connectivity by creating reliable transport networks and intermodal connections with the hinterland. Multilevel and inter-sectorial working is the prerequisite to overcome not only huge infrastructure disparities in the Adriatic-Ionian (ADRION) region, but also to find solutions for recognized administrative and sectorial bottlenecks. This paper gives rationale and explores possibilities for development of Sustainable Multimodal Transport and Mobility Network in the Region in scope of the INTERREG European Territorial Cooperation ADRION programme 2014-2020 (ADRION Programme), Priority Axis 3: Connected region.

*Keywords: Sustainable mobility and multimodal transport planning*

### 1 Introduction

“The overall ADRION Programme strategy is formulated in direct response to the EU2020 strategy of smart, sustainable and inclusive growth and its further revisions. Smart growth means improving the EU’s performance in education, research/innovation and digital society. Sustainable growth means building a more competitive low-carbon economy that makes efficient, sustainable use of resources. Inclusive growth means raising Europe’s employment rate – more and better jobs, especially for women, young people and older workers, helping people of all ages to raise the employment rate.” [2] In the case of the ADRION Programme, it has also to address the political dimension of the integration of the Western Balkans to the EU. Knowing that transport is fundamentally international, EU White Paper on transport recognized challenges related to the development of transport beyond the EU borders – the external dimension as one of strategic priorities. In that light, Commission will amongst others focus on the following area of action: “Develop a cooperation framework to extend our transport and infrastructure policy to our immediate neighbours, to deliver improved infrastructure connections and closer market integration, including in the preparation of mobility continuity plans, to deliver closer market integration”. [3]

Furthermore, one of the EUSAIR indicative actions aligned with the ADRION Programme is “Developing the Western Balkans comprehensive network: Western Balkans need to prioritise investments on the defined SEETO comprehensive network (railway, inland waterways, nodes

and hubs, notably with the motorways of the sea), aimed at promoting sustainable transport in the Region, and to prepare their integration in the Trans-European Network Transport (TEN-T). This implies elaborating integrated planning for infrastructure developments and defining joint roadmaps for investments.” [1]

“Sustainable growth requires sustainable and accessible transport and energy infrastructure, a competitive economic base and a resource efficient economy”. “Integration of the South East Europe (SEE) transport system in the European remains a priority for the region over the long term. Enforcement of market rules in transport, removal of cross-border bottlenecks and transport non-physical barriers, as well as enhancing the rules and practices in the areas of transport safety, are important issues for transport facilitation. The long-term aim of the SEE 2020 Strategy is to ensure transport services that are affordable, reliable and sustainable, and at the same time building a more competitive economy, while making efficient use of resources, protecting the environment and reducing emissions.” [4]

### **Key Strategy actions in Dimension I – ‘Transport’**

- Develop and implement measures to Improving the utilization rate of transport infrastructure on the SEETO Comprehensive Network by removal of physical and non-physical bottlenecks and unnecessary technical cross border barriers,
- Develop co-modal solutions by optimization of individual transport modes and focus on energy efficient and environmentally friendly transport modes,
- Introduce measures for reducing energy consumption and costs per unit of transport service,
- Put forward measures to improve the ratio of railway and waterborne transport, foster liberalisation of railway services and open the rail transport market to competition,
- Increase the use of Intelligent Transport System in the transport sector.

(Source: South East Europe 2020 Strategy)

### **1.1 EUSAIR and INTERREG ADRION Programme**

Members of the AIC, are convinced that the EUSAIR will give new impetus for cooperation and investment to the benefit of all involved and to the peace and security of the entire area. The EU’s Strategy builds on the Adriatic-Ionian Initiative, which was launched in 2000 and involved eight countries: four EU Member States (Croatia, Greece, Italy and Slovenia) and four non-EU countries (Albania, Bosnia and Herzegovina, Montenegro and Serbia) with the aim of strengthening regional cooperation, to promoting political and economic stability thus creating a solid base for the European integration process. “The general objective of the Strategy is to promote sustainable economic and social prosperity in the Region through growth and jobs creation, and by improving its attractiveness, competitiveness and connectivity, while preserving the environment and ensuring healthy and balanced marine and coastal ecosystems. This will be achieved through cooperation between countries with much shared history and geography.” [5] The EUSAIR is built on four thematic pillars: Blue Growth; Connecting the Region; Environmental quality; and Sustainable tourism. Moreover, Strengthening R&D, Innovation and SMEs and Capacity building, including communication are two cross-cutting aspects across each pillar. The EUSAIR will mobilise and align existing EU and national funding instruments for each of the topics identified under the four pillars. In particular, the European Structural and Investment Funds (ESIF) for 2014-2020, as well as the Instrument for Pre-accession Assistance (IPA) for non-EU countries, provide significant financial resources. The macro-regional approach has already been embedded in the new Regulations for the programming period 2014-2020. The Western Balkan Investment Framework (WBIF) provides finance and technical assistance for strategic investments, particularly in infrastructure, energy efficiency and private sector development. The European Investment Bank (EIB) and

other international financial institutions can also mobilise financing and expertise in support of suitable projects.

ADRION Programme intends to strengthen cooperation by means of actions conducive to integrated territorial development linked to the Union's cohesion policy priorities. "The overall objective of the Programme is to act as a policy driver and governance innovator fostering European integration among Partner States, taking advantage from the rich natural, cultural and human resources surrounding the Adriatic and Ionian seas and enhancing economic, social and territorial cohesion in the Programme area. The ADRION Programme includes a wide transnational area with more than 70 million inhabitants, and has distinct physical, environmental, socio-economic and cultural characteristics. Hence, it addresses all three dimensions of sustainability, including social, economic and environmental aspects but also institutional elements. One of the main features characterizing the Programme's area is the imbalance in the development of infrastructures and modes of transport, both between the two banks of the Adriatic Sea and among the Partner States, due to structural weaknesses, low level of maintenance and little investments in infrastructures. As a transnational cooperation programme, its main contribution will be to exchange and transfer experiences between regions, support transnational interventions and capacity building, and ensure that results are disseminated and used beyond project partners reaching a large number of end-users. The programme will especially support the constitution of multilevel and inter-sectoral working teams and partnerships to overcome administrative and sectoral bottlenecks, with the involvement of citizens, and local/regional/national/international bodies. At territorial level, a key issue will be to reduce conflicts of land use that constitute one main aspect of sustainable development strategies (promotion of renewable energy, protection of natural and cultural heritage, reduction of carbon emissions, etc.). Among the framework conditions for the implementation of actions, stakeholders must bear in mind that projects are not aimed to answer to the needs of a limited number of partners, but to contribute to better living conditions in ADRION territories (economic activities, quality of the environment, safety, etc.), thus focusing more on activities and results. From the action and output point of view, taking into account its strategy, the ADRION Programme shall mainly support the delivery of the following outputs:

- Networking structures;
- Joint management systems and cooperation agreements;
- Strategies and action plans;
- Methodologies and tools; and
- Pilot actions.

The ADRION Programme will neither support heavy investments, development of large infrastructures nor scientific and technology research as such. Investments in small scales facilities or infrastructures might be supported in duly justified cases in the case of pilot projects and territorial experiences. The ADRION Programme shall support in particular intangible or "soft" actions which could potentially have a long term effect and contribute to the visibility to the Programme (studies and research, networking, dissemination of knowledge and data, etc.). [2]

### **1.1.1 The EUSAIR Pillar 2: Connecting the region**

Fragmentation in the Adriatic and Ionian Region has resulted in infrastructure disparities – particularly between the EU-Member States and the non-EU countries. Better transport and energy connections are needed, and are pivotal for the Region's economic and social development. The 'Connecting the Region' pillar will improve transport and energy connectivity by: strengthening maritime safety and security and developing a port system; creating reliable transport networks and intermodal connections with the hinterland; establishing a well-interconnected and well-functioning internal energy market. Intermodal connections to



hinterlands must be upgraded to cope with increased maritime transport of goods. Together with inland waterways, road and rail provide important international connections within the Region. Ports of the Adriatic and Ionian seas, as well as railway lines and airports, are immediate entry points to the Region from abroad. An appropriate transport approach has to take all of these into account, while also considering environmental aspects, economic growth and social development. Cooperation is needed to reduce bottlenecks, and develop infrastructure networks and regulatory frameworks. Improving the institutional and administrative capacities of national and regional bodies responsible for transport will accelerate the process. Communication and awareness raising is crucial for active participation in the decision making process.

### 1.1.2 ADRION Programme Priority Axis 3: Connected region

“The ADRION Programme Priority Axis 3 on sustainable transport and mobility addresses directly the EUSAIR Pillar 2 on connecting the Region and indirectly Pillar 3 through the promotion of environmental friendly low carbon transport and also Pillar 4 as a prerequisite for tourism (see Figure 1). Priority Axis 3 of the EUSAIR is containing a territorial dimension per se by addressing connectivity in the context of the spatial disparities between West and East but also across the dominating Adriatic and Ionian seas in the core of the ADRION area. The Programme is focusing on multimodality, logistics and environmental friendly and low carbon transport and mobility, contributing thus to the conciliation of the different uses and needs among regions and users.” [2]



Figure 1 Links between the EUSAIR and the ADRION Programme

“For each Thematic Objective (TO), a set of specific Investment Priorities (IP) is pre-defined reflecting the challenges ADRION regions are facing. The cornerstone for the selection of the TOs and IPs are: The diagnosis and needs identified for the ADRION area; The lessons learnt from the period 2007-2013; The application of thematic concentration on a small number of priorities as stipulated in the ETC regulation; The complementarity with the EUSAIR and other EU Macro-regional strategies, regional and thematic programmes; The specificities of transnational cooperation programmes.” [2] ADRION Programme recognized as priority TO 7: Promoting sustainable transport and removing bottlenecks in key network infrastructures by: IP 7c: Developing and improving environmental-friendly (including low-noise) and low-carbon transport systems including inland waterways and maritime transport, ports, multimodal links and airport infrastructure, in order to promote sustainable regional and local mobility and

set specific objective 3.1 as one of targets in 1<sup>st</sup> call for proposals. SO 3.1: Enhance capacity for integrated transport and mobility services and multimodality in the Adriatic-Ionian area.

## 2 The SuMMoN Project

During last two decades IPSA INSTITUTE has significantly participated in rehabilitation of Bosnia and Herzegovina infrastructure systems that were more or less damaged during the 1990s war. As the most of the projects had been financed through different EU programmes (e.g. PHARE, CARDS, IPA etc.) through all those years IPSA gained valuable experience and established itself as a reliable partner for the EU. Recently, in light of long waited progress on the countries' way towards the EU integration, IPSA has redefined its business strategy towards a stronger commitment to the EU integration process by developing a sustainable transport system based on regional cooperation and transfer of best practices. Having that in mind, IPSA's team of experts generated and refined idea presented hereinafter.

The idea to cooperate with partners through Initiative for development of Sustainable Multimodal Transport and Mobility Network in the Adriatic-Ionian Region (SuMMoN) was generated in spring 2015. Since the EUSAIR had been recognized as ideal framework for the SuMMoN project refinement, by the end of 2015 IPSA had the project proposal outlines ready for the expected ADRIION Programme 1<sup>st</sup> call for proposals. Finally, the SuMMoN project idea was validated by the ADRIION Programme Joint Secretariat and submitted in time.

### 2.1 The project objectives and the main outputs

The SuMMoN project overall objective is to overcome huge infrastructure disparities, as well as administrative and sectorial bottlenecks through multilevel and inter-sectorial cooperation for development of sustainable multimodal transport and mobility network in the ADRIION region. This objective is not only fully aligned with the SO 3.1, but also with the following ADRIION programme overall objective: "to better identify development potential and bottlenecks in specific sectors at transnational level, to support stakeholders promoting novel approaches and sharing knowledge". Establishing a quadruple helix partnership for development of sustainable multimodal transport and mobility network is not only essential to reach the said objective but also exactly what the ADRIION programme will support in order to overcome administrative and sectorial bottlenecks, with the involvement of citizens and other stakeholders.

**Table 1** Overview table on project outputs as defined in the work plan

Programme output indicators	Project main output
Ol_7c.1_1 Number of supported transnational cooperation networks in the field of environment-friendly and low-carbon transport systems	Networking Structure
Ol_7c.1_2 Number of strategies and action plans developed in the field of environment-friendly and low-carbon transport systems	Strategy and Action Plan for development of sustainable multimodal transport and mobility in the ADRIION region

Moreover, to fulfil the specific objectives listed below, the SuMMoN project partners will jointly prepare a strategic paper for development of sustainable multimodal transport and mobility in the ADRIION region accompanied with the action plan based on transfer of best practice. Close cooperation with SEETO is foreseen to stimulate cooperation of stakeholders tackling projects of regional importance and to adopt EU supported concepts. The Project outcomes will generate wide range of impacts benefiting different target groups, especially the public. Cost effective sustainable transport solutions by making the best use of existing

resources and best practices from previous EU projects, contributing to a sustainable concept of achieving set objectives with less expenses will be put in focus. The SuMMoN project specific objectives are:

- To identify/address both administrative and sectorial challenges for development of sustainable multimodal transport and mobility in the region;
- To build/strengthen capacities for the implementation of joint solutions for previously addressed challenges through the exchange of knowledge and transfer of best practice;
- To develop an integrated framework for regional cooperation defining how the good practices will be implemented in the strategy/policy papers of each participating region/country

## 2.2 Partnership

Seven organizations from five different countries of which six EU partners (two from Greece, two from Italy one from Slovenia and one from Croatia) and one non-EU partner (IPSA INSTITUTE). SMEs from Greece and Slovenia and University from Italy will contribute to defined project Work packages (WP) accordingly. Italian Public institution (Lead partner) is responsible for the project management and coordination (WP 1), Croatian Cluster is responsible for networking structure establishment (WP 2), SME from Bosnia and Herzegovina for Strategy and Action plan drafting (WP 3), while NGO from Greece will be in charge for Communication and dissemination (WP 4). The ADRION Programme foresees the involvement of associated partners, i.e. those bodies willing to be involved in a project with an observer or associated status without financially contributing to the project. Eight institutions including SEETO expressed their interest to participate in the SuMMoN project as associated partners. Obligations of the Lead partner and the Project partners for the ADRION Programme are laid down in the Subsidy Contract and in the Partnership Agreement respectively. The Subsidy Contract determines the rights and responsibilities of the Lead Partner – according to the lead partner principle – the conditions for the project implementation, requirements for reporting, financial controls, litigation etc. The Partnership Agreement transfers rights and responsibilities from the Lead Partner to the Project partners.

## 2.3 The Project approach

The SuMMoN project will stimulate regional cooperation of stakeholders in planning and development of infrastructure works and improved operation of transport systems between the countries in the Region. The project will summon institutional stakeholders, Universities, SMEs and NGOs from the region through the systematic establishment and management of communication, interaction, and coordination with a long-term aim to improve connectivity. Established networking structure will upon detailed state-of-the-art analysis build on existing knowledge and experience from previous projects (e.g. MEDA, TRACECA, GIFT, TRANSIT, SEETAC, ACROSSEE etc.) and from EU supported regional initiative – SEETO. The project will establish a system based on shared joint management of topics of mutual concern to promote the best practice transfer ensuring that results are disseminated and used beyond project partners. All participants of the established networking structure shall sign a Memorandum of Understanding for development of Sustainable Multimodal Transport and Mobility Network in the ADRION region. The inclusion of the perspective of all stakeholders by applying the quadruple helix model preceding the Strategy and Action Plan drafting will provide governments with a useful tool for adopting further transport strategies and planning resources, the transfer of knowledge between the industry and universities (with students gaining a hands-on insight into trends in low-carbon and sustainable transport) will be expedited, SMEs which are usually on the implementation side of transport strategies will be able to contribute with their knowledge and benefit from gaining a fresh perspective on familiar issues through re-

gional cooperation, and finally the public (including tourists) will benefit from an improved transport network.

A strategic document that defines precisely how the good practices (e.g. implementation of SUMP or introduction of new multimodal transport and mobility services) will be implemented in the strategy/policy papers of each participating region/country will leverage future initiatives and investments. The Steering Committee (SC) will ensure the strategy implementation not only by monitoring actions proposed in the action plan but also by updating indications on future evolutions in transports and mobility field. To ensure a stronger role, the SC will be responsible for the annual verification of the application of the Covenant of Mayors in field of mobility and drive IPA partners in joining the initiative. The project is expected to set up the principles of cooperation (multi-country and inter-sectoral) as well as the goals to be achieved and the appropriate strategy to ensure a sustainable transport network and mobility development. In addition, transferring of the EU best practice will be promoted contributing to the common needs and challenges of the ADRION region. Finally, the SuMMoN project will contribute to the following ADRION Programme result indicator: Level of capacity of organisations in the field of transport and mobility to transnationally plan and implement sustainable and multimodal transport and mobility solutions.

### 3 Conclusions

“Initiative for Development of Sustainable Multimodal Transport and Mobility Network” represents an ultimate opportunity to enhance capacity for integrated multimodal transport and mobility services in the Adriatic-Ionian area. This should be a common interest essential for achieving the general objective of the EUSAIR and it could be implemented within scope of the ADRION Programme. The challenges posed by improving the connectivity within the Region and between the Region and the rest of the EU can only be tackled through a cooperative and coordinated approach. Networking structure based on Quadruple helix partnership principle is of essence for balanced and integrated planning of environment friendly low carbon transport systems connecting the Region with the hinterland. Strategic paper accompanied with an Action Plan for development of sustainable multimodal transport and mobility in the ADRION region are needed not only to identify methodologies and tools for removal of identified sectorial and administrative bottlenecks but also to provide sustainable multimodal transport and mobility solutions based on transfer of knowledge and best practices.

### References

- [1] Commission staff working document Action Plan Accompanying the document Communication from the commission to the European Parliament, the Council, the European Economic and Social Committee and the Committee of the Regions concerning the European Union Strategy for the Adriatic and Ionian Region, Brussels, COM(2014) 190 final of 17.6.2014
- [2] European Regional Development Fund: Interreg V-B ADRIATIC-IONIAN COOPERATION PROGRAMME 2014-2020, Approved on 20 October 2015
- [3] European Commission’s White Paper ‘Roadmap to a single European transport area — Towards a competitive and resource-efficient transport system’ COM (2011) 144 final of 28 March 2011
- [4] South East Europe 2020 Strategy – Jobs and Prosperity in a European Perspective, Regional Cooperation Council, Report published on 21.11.2013
- [5] Communication from the Commission to the European Parliament, the Council, the European Economic and Social Committee and the Committee of the Regions concerning the European Union Strategy for the Adriatic and Ionian Region, Brussels, 17.6.2014 COM(2014) 357 final





## THE EFFECTS OF FORECASTS ON THE LEVEL OF MOTORIZATION – A SELF-FULFILLING PROPHECY?

Anna Mayerthaler<sup>1</sup>, Harald Frey<sup>2</sup>, Ulrich Leth<sup>2</sup>

<sup>1</sup> *Neue Urbane Mobilität Wien GmbH, Austria*

<sup>2</sup> *Vienna University of Technology, Institute of Transportation, Research Centre of Transport Planning and Traffic Engineering, Austria*

### Abstract

Besides the population growth, the level of motorization is an essential factor influencing forecasts on transport demand carried out with transport models. Results of such models are often used in transport planning for example to scale planned road infrastructure. Looking at the development of the level of motorization in the past, it becomes apparent that permanent transgressions of the prognoses have taken place. As a consequence the ever-increasing levels of motorization were treated as “law of nature”, resulting in upward corrected prognoses. In the last decade this trend seems to be reversed. We present that in many countries worldwide the levels of motorization are stagnating or even decreasing. Especially in cities this development is obvious, showing the influence of transport policies on vehicle ownership. The common transport models did not predict this development. Additionally the strong influence of the level of motorization on the forecasts of transport behaviour is shown, based on two different scenarios. One of the scenarios is mapping the influence of transport and land-use policies on the level of motorization. In the second scenario the assumed growth of the level of motorization is fed externally into the model, therefore not being influenced by policy measures.

*Keywords: level of motorization; transport demand models; prognoses*

### 1 The level of motorization in transport demand modelling

Population growth and the level of motorization are both strong influencing factors in forecasts of transport demand. The population is directly influencing trip generation (first step of a classical four step approach) and the level of motorization is influencing trip distribution and mode choice (step two and three) via vehicle availability and finally also influencing traffic assignment. The level of motorization is often modelled or estimated by a Gompertz-function, with an assumed saturation point following an “S”-shape. Figure 1 presents the used Gompertz-curves in the Austrian transport prognosis 2025+.

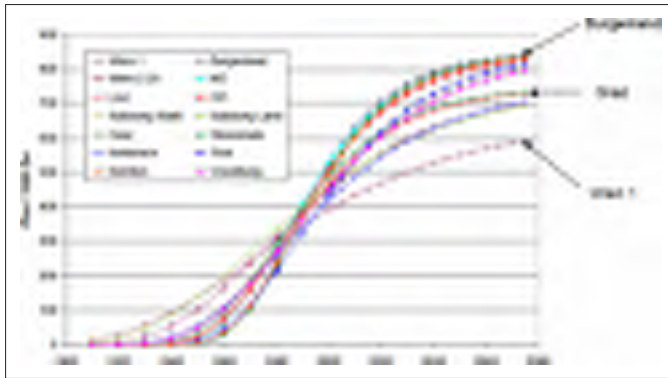


Figure 1 Development of the level of motorization in the Austrian transport prognosis 2025+. Source: [1]

## 2 The interrelation between prognoses and actual development

In the 1950ies the prognosis for Germany predicted the culmination of mass motorization with 63 vehicles/1,000 inhabitants. The development though overtook this prognosis after a short period of time. Prognoses followed prognoses and the values for the level of motorization had to be corrected upwards several times [2]. Applying a rational thought it must have been obvious that the prognoses are not mapping the system correctly and appropriate measures should have been taken. Instead politicians and transport planners have looked blank on this momentum of development [3].

The Buchanan Report “Traffic in Towns”, which was produced in 1963 for the UK Ministry of Transport, suggested that traffic would saturate early in the 21<sup>st</sup> century. Rode et al.[4] are pointing out, that it has become increasingly difficult to operate with a traditional ‘predict-and-provide’ model of urban transport planning. Most importantly, it should be noted that there is a considerable risk of overestimating the growth of private vehicle stock and car use, as most growth projections simply extrapolate historic trends without adequately incorporating evidence on changing patterns of mobility and their relationship to income and economic growth [5, 6]. Analysis of recent traffic forecasting in both the UK (Figure 2) and US (Figure 3) has indicated that transport planners have consistently overestimated future car traffic growth in the previous two decades, with significant distortive effects on transport planning investments.

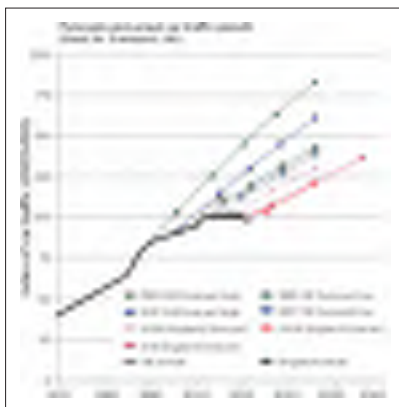


Figure 2 Forecast an actual car traffic flow for the UK. Source: [5]

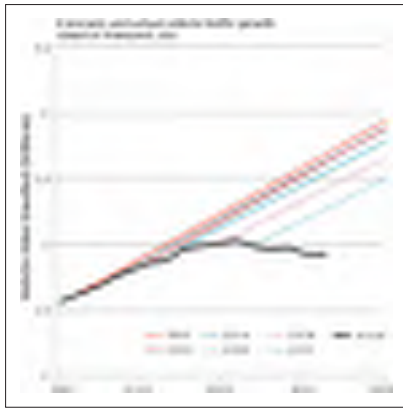


Figure 3 Forecast an actual car traffic flow for the US. Source: [6]

What was the reason for the ever-increasing level of motorization? Why did the actual development overtook the levels in the prognoses and required a correction upwards? The reason is, that the levels in the prognoses were the basis for the development of the road infrastructure, Figure 4. Based on the future level of motorization the infrastructure for the individual motorized transport was over dimensioned. With the permanent attempt to avoid congestion and to keep the current system speeds, the increased demand was answered by an increased supply (which again increased demand).

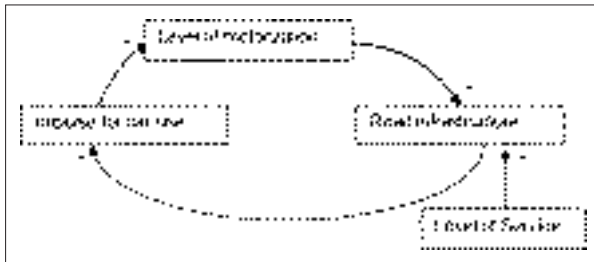


Figure 4 Feedback loop between level of motorization and the road infrastructure. Authors own representation

The structures were built alongside the developments in the prognoses. The changes in structures led to changes in behaviour, which became visible through data. The isolated consideration of car-data (level of motorization) and the orientation of transport planning led to car-structures and car-behaviour, which resulted in car dependence and a lot of so called transport problems, Figure 5.

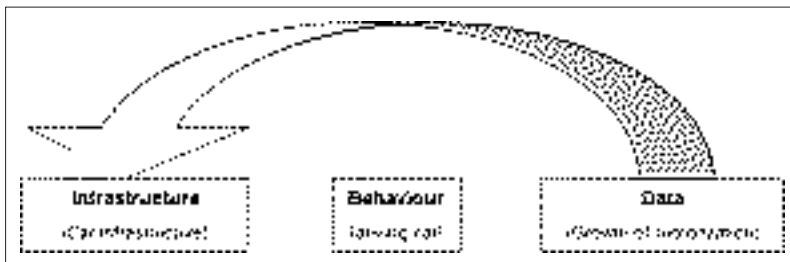


Figure 5 Data is reflecting the infrastructure in the transport system. Authors own representation

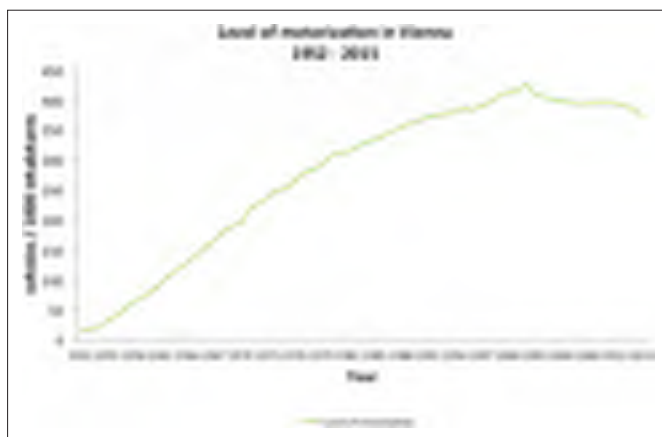


### 3 Actual developments of the level of motorization

The thesis in the past was, that there is a causal relation between the GDP growth and the development of the level of motorization. Till today the traditional transport planning assumes that an increase in income correlates with an increase in the level of motorization [3].

Instead it becomes apparent that in cities with a good public transport system and dense city structures even with high incomes the level of motorization is below the levels in rural areas, which make the possession of car necessary. The development of the level of motorization for cities like Hong Kong, Singapore or New York show a decoupling of GDP and level of motorization [7, 8].

The idea of banning, or at least reducing, the use of automobiles in city centres has become an increasingly hot topic among urban planners, especially in Europe and other industrialized countries dealing with issues as diverse as congestion and smog. A number of major cities, like Paris, London and even New York, have been exploring ways to reduce the number of vehicles on their streets [9]. Also in Vienna, looking at the development from 2003 till now, the level of motorization is decreasing, reaching 372 vehicles / 1000 inhabitants in 2015, a value similar to the values in 1991/92., Figure 5.



**Figure 6** The development of the level of motorization in Vienna. Calculated from [10, 11], authors own representation.

Even if we assess the levels of motorization on a nationwide scale there are signs for “demotorization”. In 2004 “peak car use” happened in the US, UK, Germany, France, Australia and Sweden and all saw the start of a decline in the number of kilometres the average person travelled in a car that continues till today. That year in Australia, car travel peaked in every city in 2004 and has been falling since [12]. It is a similar picture in the UK, where per-capita car travel is down 5 per cent since 2004.

### 4 Presentation of the use of the level of motorization in modelling

The lines of argument given above will be emphasised further by presenting the strong influence of the level of motorization on forecasts of transport behaviour, based on two different scenarios. These scenarios were modelled with a transport interaction model called MARS [13]. MARS was primary applied on a series of urban case studies. The MARS model was further developed to use it for the whole territory of Austria and to model the impacts of transport and land-use policies on a national scale in a forecasting approach [14]. The presented scenario results are taken from the thesis where starting from a “business as usual” scenario,

which depicts the development over time without any substantial changes, different policy scenarios were developed.

One of the scenarios is mapping the influence of transport and land-use policies on the level of motorization (450 ppm, ppm = parts per million). In the second scenario the assumed growth of the level of motorization is fed externally into the model, therefore not being influenced by policy measures (BAU).

Figures 7 and 8 present the results of the modelled scenarios as modal split for the years 2010, 2015 and 2050. In the BAU scenario the share of PMT is increasing till 2050 reaching 65 %. In the 450 ppm scenarios the implemented policy measures in combination with the decreasing level of motorization show a decrease of the PMT share to 53 % in 2050.

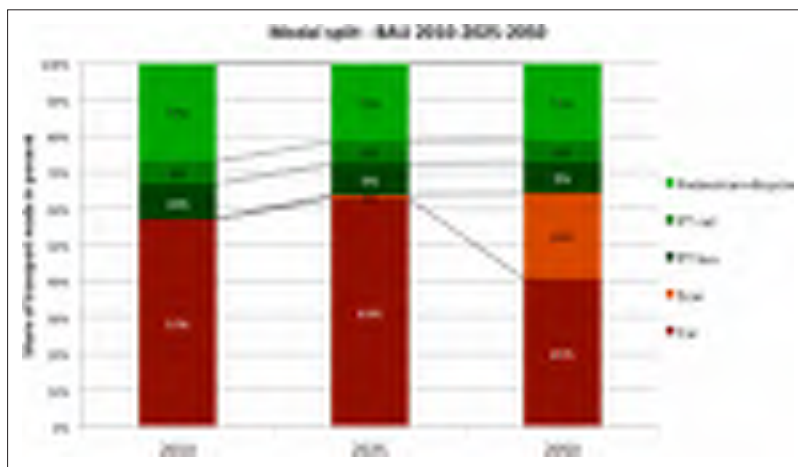


Figure 7 Modal split in total for the scenario BAU, years 2010, 2015 and 2050, source [14, p. 145]

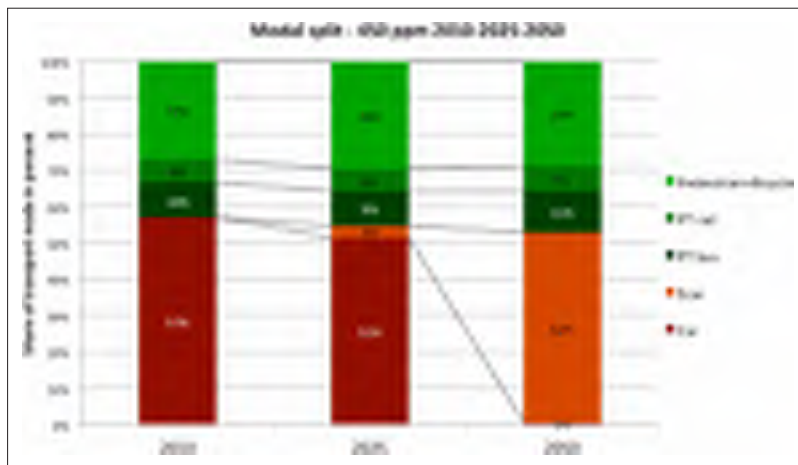


Figure 8 Modal split in total for the scenario 450 ppm, years 2010, 2015 and 2050, source [14, p. 167]

As it can be seen the modal split for the mode car/e-car is smaller in the 450 ppm scenario (where the influence of transport and land-use policies on the level of motorization is modelled) as in the BAU scenario (where an increase in the level of motorization is still assumed), also the share of the level of motorization is increasing till 2050.

## 5 Conclusions

The paper presents the influence of the level of motorization on forecasts and the usage of the forecasts in transport planning. When looking at the past, permanent transgressions of the prognoses have taken place, leading to ever increasing levels of motorization. The forecasts are based on model results produced by model structures, which are not capturing feedbacks between policy measures and the development of the level of motorization. Though we show that this trend seems to be reversed looking at developments in many countries and cities worldwide the common used transport models still don't predict this development. Taking the development of motorization into account we can summarize, "we get what we expect", the positive feedback between belief and behaviour is obvious in the man-made exponential growth of motorization in the last decades. A break of this vicious circle is only possible if external targets and guidelines outside the transport system are set.

## References

- [1] TRAFICO – Verkehrsplanung Käfer GmbH, et al., Verkehrsprognose Österreich 2025+, Enbericht Teil 1. Vol. Hintergrund, Aufgrabestellung, generelle Methode und Prognoseannahmen. 2009, Wien: BMVIT – Bundesministerium für Verkehr, Innovation und Technologie.
- [2] Knoflacher, H.: Landschaft ohne Autobahnen. für eine zukunftsorientierte Verkehrsplanung. 1997, Wien, Köln, Weimar: Böhlau Verlag
- [3] Knoflacher, H.: Grundlagen der Verkehrs- und Siedlungsplanung 2007, Wien: Böhlau Verlag Ges.m.b.H und Co.KG.
- [4] Philipp Rode, et al.: Toward New Urban Mobility: The case of London and Berlin Peter Griffiths (ed), L. Cities/InnoZ, Editor 2015, London School of Economics and Political Science: London.
- [5] Goodwin, P.: Due diligence, traffic forecasts and pensions. Local Transport Today, 2012. 594.
- [6] Williams-Derry, C.: "Traffic forecast follies – The US DOT refuses to learn from recent travel trends.". 2013 [cited 2014 28th May]; Available from: [daily.sightline.org/2013/12/23/traffic-forecast-follies/](http://daily.sightline.org/2013/12/23/traffic-forecast-follies/).
- [7] Worldbank, Motor vehicles (per 1,000 people), 2016.
- [8] Sperling, D., Claisen, E.: The Developing World's Motorization Challenge. Issues in Science and Technology, 2002. XIX(1).
- [9] Eisenstein, P.A.: A ban on autos? Major cities consider going carless. [cited 2016 7th April]; Available from: <http://www.cnn.com/2014/01/24/a-ban-on-autos-major-cities-consider-going-carless.html>.
- [10] Statistik Austria, PKW-Bestand nach Bundesländern, 2013: Vienna.
- [11] Statistik Austria, Bevölkerung seit 1869 nach Alter für Bundesländer, 2016.
- [12] Newman, P., Kenworthy, J.: Peak Car Use: Understanding the Demise of Automobile Dependence. World Transport, Policy & Practice. 17.2.
- [13] Pfaffenbichler, P.: MARS – Metropolitan Activity Relocation Simulator. A System Dynamics based Land Use and Transport Interaction Model 2008, Saarbrücken: VDM Verlag Dr. Müller.
- [14] Mayerthaler, A.: Reducing CO2 emissions in the passenger transport sector in Austria – a modelling approach with MARS Austria (MARS-Metropolitan Activity Relocation Simulator), 2013, Vienna University of Technology: Vienna.



## ANALYSIS OF HEADWAY CHARACTERISTICS IN DISSIPATING QUEUES

András Szele<sup>1</sup>, Árpád Barsi<sup>2</sup>, Lajos Kisgyörgy<sup>2</sup>

<sup>1</sup> *Institute for Transport Sciences, Hungary*

<sup>2</sup> *Budapest University of Technology and Economics, Hungary*

### Abstract

Congestion related traffic flow management requires the thorough analysis of dynamics of queues to develop effective control strategies. Traffic operation of signalized intersections is often hindered by congestions. Queues cause an additional delay decreasing the capacity of the intersection, because in dissipating queues the headways are longer than in saturated flows. Thorough analysis of dynamics of queue development and dissipation is important, because precise estimation of start-up lost times of dissipating queues can help to minimize this capacity decrease due to the presence of queues. This paper analyzes the dynamics of queue dissipation and its major influencing factors. Queue dynamics data were collected in several locations in Budapest, Hungary using action cameras. We used exploratory data analysis to determine the principal components behind headway increments in dissipating queues and their importance. We identified those components which correlates to the traffic flow characteristics and can be influenced by traffic management tools.

*Keywords: headway, queue dissipation, queue discharge, image analysis, congestion management*

### 1 Introduction

Congestions in modern cities are the normal way of traffic operation nowadays. Congestions and congesting traffic operation cannot be efficiently managed by the traditional tools of traffic engineering, they require a different, a congestion related approach. The congestion related approach accepts congestions, tries managing instead of avoiding them [1].

Congestion relating flow management requires the thorough analysis of dynamics of queues to develop effective control strategies. Queues are inherent features of congestions, their formation and dissipation takes more time than the normal operation of traffic. If the dynamics of queue dissipation was fully understood it could be influenced by traffic control tools to increase the efficiency of traffic operation and decrease the delay. Adequate queue discharge/delay models are essential to the analysis and optimization of signal control strategies as well [2, 3]. Headway inside the dissipating queue is one of the dynamical features of interest, because it directly related to delay. In the literature several studies can be found on headway, however their findings are conflicting. Each of them confirms the start-up lost time at the first few vehicles, but after that the paths diverge. One group of the studies finds no change in headway values. HCM 2010 assumes a constant headway after the first few vehicles [4], which assumption is confirmed by some studies [5, 6]. However other researchers reported compressing headway along the dissipating queue [7-13]. They account this phenomenon for the tailgating and hurrying drivers at the end of the queue. On the other hand other studies found the headway would get longer after a certain point of time as the queue dissipating [14-17]

These contradicting findings imply that some traffic operational parameters influence the dynamics of queue dissipation, so more explanatory queue dissipation models are needed. Rouhani analyzed the effect of these parameters, ignored in the usual queue dissipating models and analysis, on the dissipation of queues in signalized intersections [18]. He concluded that the dynamics does not depend solely on location but on other factors such as green time and ratio of heavy vehicles as well.

Measuring headway is far from trivial. Traffic monitoring cameras and evaluating software do exist, but they are usually immobile. In our research we developed a method for commonly used action cameras, which is very suitable for determining traffic operation parameters easily, conveniently and effectively at almost any location.

This paper introduces an innovative solution to measure headways and tries to identify the principal components which influence them. Queue dynamics data were collected in locations in Budapest, Hungary using action cameras. We used exploratory data analysis to determine the principal components behind headway increments in dissipating queues and their importance, and we identified those components which correlates to the traffic flow characteristics and can be influenced by traffic management tools.

## 2 Methodology

In this research we examined the effect of certain factors on the headway in dissipating queues formed during the red sign. The location, the lane configuration and the type of traffic operation were included into the analyses. Locations and time of the analysis were chosen to represent these factors. We examined the effect of lane configuration by comparing the traffic operation of a one-lane direction to the traffic operation of the lanes of a two-lane direction. We analyzed if there is any difference in queue dissipation between the case of the single lane, of the right lane and of the left lane case. We also include a left turning lane and an on-ramp to the analysis.

We set the measure period when the traffic operation was congested. We defined the traffic operation congested if all the queuing vehicles could not go through the green light. The influence of the parameters was evaluated by analysis of variance.

## 3 Data collection method

The data collection was made by recording videos about the discharging traffic queues then the headways for different queue positions were determined by image analysis. Data collection time periods focused on the morning rush hours, under normal weather and traffic conditions. The applied system was an SJ4000+ action camera made by SJCAM. The camera has a lens of 2.99 mm focal length; the field of view is 170°. The camera is able to record videos with a resolution of 2K (2048 × 1080 pixels), but actually we had it with full HD (1920 × 1080 pixels). This resolution has enough details if later analysis has to be done. The frame rate was 30 fps which is also adequate for recording traffic events in cities. The camera was set for cyclic recording, which means the monitored period was automatically split into 5 minute parts. This enabled easier processing hence the handling of the videos doesn't require extreme memory in the computers. The storage format was mp4 without sound recording. A 5-minute part with these settings was about 560 MB. The camera was equipped with 64 GB microSD card for storing the videos.

The first processing step was the format conversion from mp4 into avi because of the image processing environment. The evaluation of the videos was in MathWorks Matlab supported several codecs, but not the same having actually in the action camera. The conversion has kept all essential parameters (resolution, frame rate, image quality). To ease the video processing on an average laptop, the resolution was decreased to 360p format, meaning an image size of 360×640 pixels.

The processing algorithm is the following. The first 50 frames of the recorded video footage were used to create a reference. The reference is a base, which has mostly the background, the lanes, the trees, the non-moving vehicles and all “irrelevant” image content. The important part of the image is the foreground aimed to contain only vehicles. Then the coming frames were compared to the reference to extract the difference, in this case the vehicles. All so detected vehicles are in form of a binary blob, where the center or the boundary box are easily to calculate. These features enable to represent the vehicles in a simple way, then passing a cross section has to be registered. The registration times can be used to compute the follow-up times for a sophisticated traffic analysis.

## 4 Data

We chose two locations to collect data for our research. In both locations the traffic operational conditions were ideal for the analysis of queue dissipation dynamics: the queues can discharge freely, no turning movements or side streets to influence the operation, frequent congestions and no heavy trucks or buses. The first location, Egér road is a busy commuter route on the verge of the western part of Budapest. The involved four-lane road section plays an important role in the suburban road transport, in the analyzed direction the traffic is heavily congested in the morning peak hours. The cycle length of the intersection is 120 s with 86 s green time for the analyzed direction. Figure 1 shows the layout of the location.

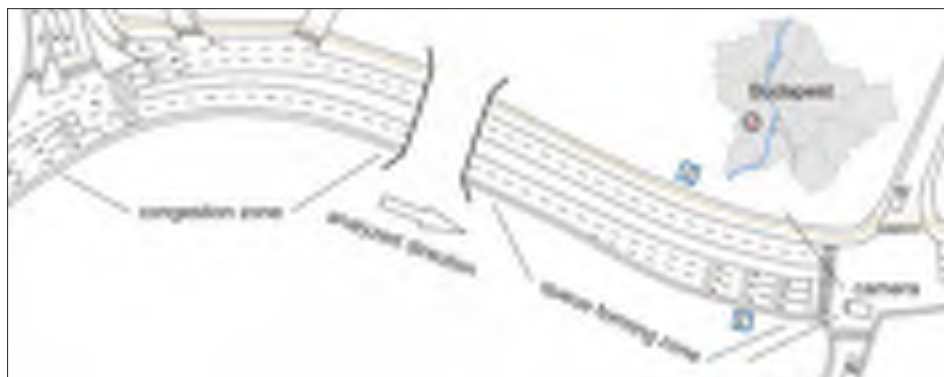


Figure 1 Location 1: Egér út, Budapest

The second and third locations were the lower quay on Buda side, which is an all day busy urban transport artery across the heart of Budapest (Figure 2). The involved two-lane road section plays an important role in the long-distance urban road transport and the city logistic. Two traffic direction were examined as it shown in Figure 2. The first one goes straight to north, this is the main direction, the second one ingress the main stream in the analyzed intersection. Both analyzed directions are heavily congested in the morning peak hours. The speed limit is 50 km/h, the cycle length is 90 sec. The main direction has 51 sec green time, the minor stream has 35 sec. 40 cycles of data were conducted in the morning peak hours in the intersection.

The fourth and fifth measure spots located in the same intersection (Figure 3). The two-lane road links the high prestige residential zone of Buda hill and the city center. We analyzed two directions in the intersection. Figure 3 shows the layout of the location and the examined directions. The first direction goes straight to the city center, the second direction turns left. Both analyzed directions are congested in the morning peak hours, the congestions in the left turning stream are more excessive. The speed limit is 50 km/h, the cycle length of the intersection is 90 sec. The first direction has 50 sec green time, the second direction has 20 sec.

The data collections were conducted in the morning peak hours. We collected 6-13 cycles of data for the analysed traffic flows, depending on the cycle time of signalization.

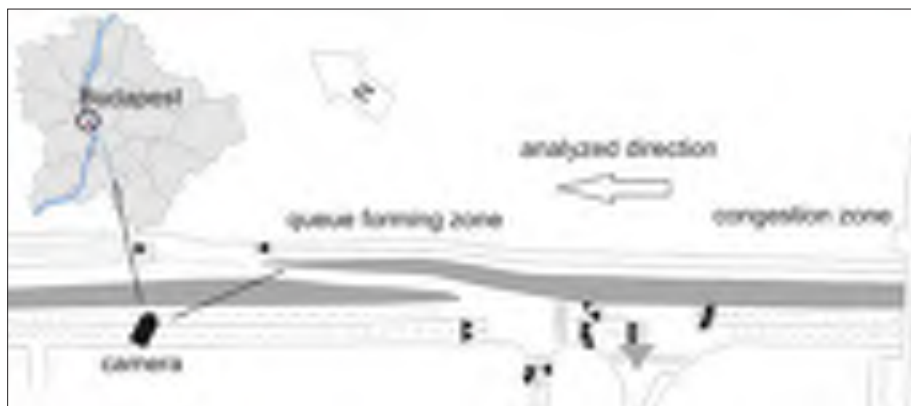


Figure 2 Location 2: Műgyetem rakpart, Budapest



Figure 3 Location 3: Hűvösvölgyi út út, Budapest

## 5 Data analysis

The headway data are presented graphically in Figure 4-6. The results do not justify any of the three assumptions mentioned in the literature: the headway values are not constant, not compressing nor get longer. According to our findings the lanes of two-lane directions are used in an unbalanced way. This is due to the continuous lane changing to overtake the slower vehicles, so the left lane has significantly lower values than the right one. Another case of interest is the smaller headway values in the left turning lane. Again the difference is significant, this phenomenon originates from the lower speeds of turning movements. The variance analysis did not show any other significant difference due to location or lane configuration. However the analysis of queue positions shows a very interesting repeating pattern. The headway values characteristically decreasing to the seventh-ninth position, and there comes a significant raise of headway values, which descends back to the lower levels from the thirteenth-sixteenth position. At the end of the green time aggressive tailgating can be observed, which results significantly lower headway values everywhere.



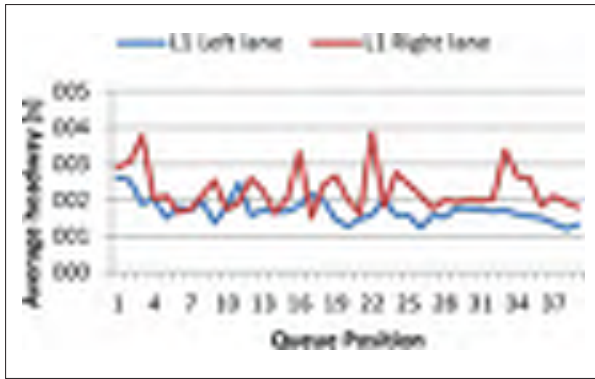


Figure 4 Average headway by queue position at Egér út (Location 1)



Figure 5 Average headway by queue position at Rakpart (Location 2)

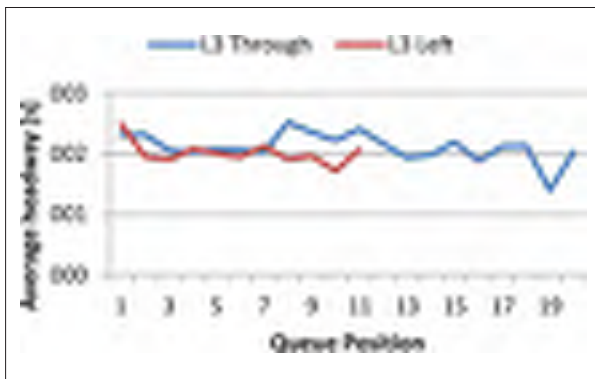


Figure 6 Average headway by queue position at Hűvösvölgyi út (Location 3)

Analysis of variance test was conducted using SPSS to determine the significance of the location, position and lane configuration. The results showed that position (sig value 0.056) and position (0.132) do not influenced headway significantly, but lane configuration (0.000) does a significant effect. However the r-squared value for this three factors is 0.239, so there are other influencing factors in the background.



## 6 Conclusions

The headway characteristics of dissipating queues were examined in Budapest, Hungary. The discharge headways did not demonstrate a constant, a compressing or an elongation trend. The data showed a regular pattern, compressing at the beginning of the queue, elongation in the middle, then compressing again. This indicates that by managing queue length at signalized intersections the delays might be decreased. The location parameters did not explain the variance in the data. The lane configuration has a significant effect on the headway in dissipating queues, so it should be taken into account in further analysis. The analyzed parameters explain only 24% of the total variance. Further research should explore these traffic parameters.

## References

- [1] Thomson, I., Bull, A.: Urban traffic congestion: its economic and social causes and consequences, CEPAL Review 76, pp. 105-116, 2002.
- [2] Yin, Y.: Robust Optimal Traffic Signal Timing. *Transportation Research Part B* 42 (2008), pp. 911–924, 2008. DOI: 10.1016/j.trb.2008.03.005
- [3] Zhang, L., Yin, Y., Lou, Y.: Robust Signal Timing for Arterials under Day-to-Day Demand Variations. *Transportation Research Record* 2192 (2010), pp. 156-166. DOI: 10.3141/2192-15
- [4] Transportation Research Board. HCM 2010 Highway Capacity Manual. Transportation Research Board, Washington, D.C., 2010.
- [5] Cohen, S.L.: Application of Car-Following Systems to Queue Discharge Problem at Signalized Intersections, In *Transportation Research Record: Journal of the Transportation Research Board*. No.1802 (2002), Transportation Research Board of the National Academies, Washington, D.C., DOI: 10.3141/1802-23
- [6] Khosla, K., Williams, J.C.: Saturation Flow at Signalized Intersections During Longer Green Time. In *Transportation Research Record: Journal of the Transportation Research Board*. No.1978, Transportation Research Board of the National Academies, Washington, D.C., (2006) pp. 61-67. DOI: 10.3141/1978-10
- [7] Bonneson, J.A.: Modeling Queued Driver Behavior at Signalized Junctions. In *Transportation Research Record* No.1365, TRB, National Research Council, Washington, D.C., (1992), pp.99-107.
- [8] Al-Ghamdi, A.S.: Entering Headway for Through Movements at Urban Signalized Intersections. In *Transportation Research Record: Journal of the Transportation Research Board*. No. 1678, Transportation Research Board of the National Academies, Washington, D.C., (1999) pp. 42-47. DOI: 10.3141/1678-06
- [9] Lin, F.B., Tseng, P.Y., Su, C.W.: Variations in Queue Discharge Patterns and Their Implications in Analysis of Signalized Intersections. In *Transportation Research Record: Journal of the Transportation Research Board*. No. 1883, Transportation Research Board of the National Academies, Washington, D.C., (2004) pp. 192-197. DOI: 10.3141/1883-22
- [10] Chaudhry, M.S., Ranjitkar P.: Capacity and Signal Timing Analysis of Signalized Intersection with Increasing Saturation Flow Rate. *Proceedings of 92nd Annual Meeting of Transportation Research Board*, Washington, DC, January 13-17, 2013.
- [11] Dey, P.P., Nandal, P., Kalyan, R.: Queue Discharge Characteristics at Signalized Intersections Under Mixed Traffic Conditions. *European Transport\Trasporti Europei Issue* 55, Paper n° 8, ISSN 1825-3997
- [12] Lee, J., Chen, R.L.: Entering Headway at Signalized Intersections in a Small Metropolitan Area. In *Transportation Research Record* 1091, B, National Research Council, Washington, D.C., (1986) pp. 117–126

- [13] Akcelik, R., Besley, M.: Queue Discharge Flow and Speed Models for Signalized Intersections. Proceedings of the 15th International Symposium on Transportation and Traffic Theory. University of South Australia, Adelaide, Australia, 2002.
- [14] Tepley, S.: Saturation Flow at Signalized Intersection Through Magnifying Glass. in Proc., Eighth International Symposium on Transportation and Traffic Flow Theory. Toronto University Press. 1983.
- [15] Li, H., Prevedourous, P.D.: Detailed Observations of Saturation Headways and Start-Up Lost Times." Transportation Research Record No. 1802, (2002) pp. 44-53, DOI: 10.3141/1802-06
- [16] Day, C.M, Sturdevant, J.R., Li, H., Stevens, A., Hainen, A.M., Remias, S.M., Bullock, D.: Revisiting the Cycle Length-Lost Time Question with Critical Lane Analysis. In Transportation Research Record: Journal of the Transportation Research Board. No. 2355, Transportation Research Board of the National Academies, Washington, D.C. (2013) DOI: 10.3141/2355-01
- [17] Gao, L., Alam, B.: Optimal Discharge Speed and Queue Discharge Headway at Signalized Intersections, Transportation Research Board 94th Annual Meeting, 2015.
- [18] Rouhani, O.M.: Queue Dissipation Shockwave Speed for Signalized Intersections. MPRA Paper No. 53161. (2013) Online at <https://mpra.ub.uni-muenchen.de/53161/>





## HYBRID ALGORITHM FOR TICKET RESERVATION PROCESS IN PASSENGER RAIL TRANSPORT

Dragana Macura<sup>1</sup>, Milica Šelmić<sup>1</sup>, Dušan Teodorović<sup>1</sup>, Milutin Milošević<sup>2</sup>

<sup>1</sup> *University of Belgrade, Faculty of Transport and Traffic Engineering, Serbia*

<sup>2</sup> *“Beograd čvor”, Serbia*

### Abstract

Managing tickets reservation process in passenger rail transport is complex task. For solving this kind of task, we develop a hybrid algorithm based on Artificial Neural Network and Payoff table as a decision support tool. The aim of the proposed algorithm is to suggest real time decisions about seat inventory allocations taking into account information from the past. The paper considers the revenue management application in passenger rail transport with variable capacity of sleeping cars. Uncertainty of available capacity is embedded in developed algorithm by Payoff table, while Artificial Neural Network is used as a tool for making real time decisions. We consider nested reservation system, and the algorithm is tested on hypothetical data.

*Keywords: Revenue management, Rail transport with variable capacity, Artificial Neural Network, Payoff table*

### 1 Introduction

The main objective of Revenue Management (RM) concept is selling the right product/service to the right customer at the right time for the right price. This concept can be applied in models with following characteristics: a fixed amount of resources available for selling; the sold resources are perishable (time limitation of selling the resources, after which they don't have value); different customers are willing to pay a different price for the same product/service. RM is widely used in the transport industry, primarily in airline sector. In railway practice, Amtrak, intercity passenger rail company in United States, is a pioneer in the application of RM. This company introduced RM almost 25 years ago. Many other railway companies also apply RM concept, such as: SNCF (Société Nationale des Chemins de fer Français) in France; GNER (Great North Eastern Railway) in Britain; DB (Deutsche Bahn) in Germany; VR Group in Finland.

The hybrid algorithm for ticket reservation process management in passenger rail transport (sleeping cars) is developed in this paper. We consider nested reservation system with variable capacity. Railway operators in transition countries, including Western Balkans, that does not know in advance the available rail capacity, since very often rail cars are not ready for use due to repairs. The uncertainty of rail car preparedness in this paper is treated by Payoff table. The main contribution of the paper is developed decision support tool which is designed for making real time decisions concerning a new passenger's request, i.e. whether to accept or refuse it.

## 2 Hybrid algorithm description

### 2.1 Important assumptions

In this Subsection we provide basic assumptions relevant for our algorithm:

- The reservation of the highest tariff class berths is always possible if there are available berths on the train.
- Requests for lower tariff classes will be accepted only if rail operator expects lower demand for higher classes.
- Capacity is treated as a variable with several possible discrete values. This is an important part of the model due to the fact that the rail operators often do not know in advance a number of available sleeping cars or railcars. The probability of engaging new sleeping cars and penalties for a wrong estimation are involved in the model.

Decisions whether to accept a new request or not in real time are made by hybrid algorithm based on Artificial Neural Network (ANN) and Payoff table. First, we use a simulation for data base of realized sleeping car reservation process from the past. This data base contains information of time when the request is received and the type of requested tariff class. Having in mind the total number of requests per tariffs, we can offline apply linear integer programming in order to obtain an optimal revenue for one train from point A to point B. This means that one optimal solution, which indicates the way of managing reservation process in order to maximize revenue, is assigned to every realization of train trip. These data are then used for the ANN training. ANN is designed to give an answer whether to accept a new passenger's request or not in real time, with available capacity at the moment. Since there is uncertainty about available sleeping cars, we embedded probability of new rail car engagement through Payoff table. If ANN suggests rejecting a new request in the case of initial capacity ( $C_k$ ), the algorithm consults Payoff table about capacity expanding. If decision maker expects capacity increasing, then the final decision is to accept new request and capacity value is changed from initial to new value. Otherwise, the request has to be rejected and reservation process terminates (Figure 1).

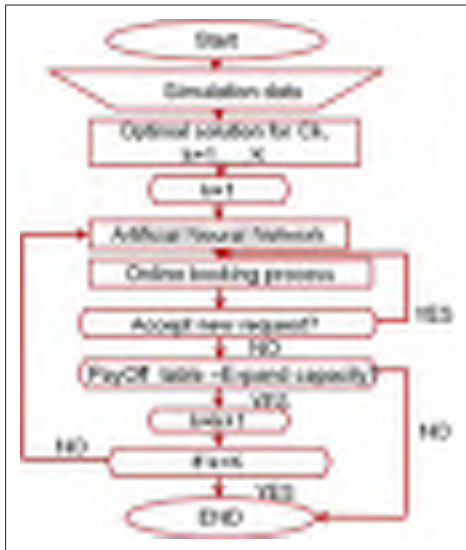


Figure 1 Hybrid algorithm

## 2.2 Simulation data

Table 1 contains cumulative numbers of the received requests for  $i$ -th tariff class in  $p$ -th realization of the reservation process obtained by simulation, and appropriate decision on accepting requests.

**Table 1** Vectors of input and output values for  $p$ -th realization of reservation process

Time until closure reservation process	Cumulative numbers of received requests per classes				Decision for Class 1	Decision for Class 2	Decision for Class n
	Class 1	Class 2	...	Class n			
$t_p(1)$	$D_1^p(t_p(1))$	$D_2^p(t_p(1))$	...	$D_n^p(t_p(1))$	Accept	Accept	Reject
$t_p(2)$	$D_1^p(t_p(2))$	$D_2^p(t_p(2))$	...	$D_n^p(t_p(2))$	Accept	Reject	Reject
$t_p(3)$	$D_1^p(t_p(3))$	$D_2^p(t_p(3))$	...	$D_n^p(t_p(3))$	Accept	Reject	Reject
...	...	...	...	...	...	...	...
$t_p(Mp)$	$D_1^p(t_p(Mp))$	$D_2^p(t_p(Mp))$	...	$D_n^p(t_p(Mp))$	Accept	Reject	Reject

## 2.3 Model for obtaining optimal solution

Let us assume that it is possible to predict time of seat reservation request, as well as preferred tariff class. This idea can be valuable only for already realized rail trips. The problem of determining the maximal revenue in the case of sleeping cars with several tariff classes on non-stop leg can be optimally solved by linear integer programming:

$$(\max)F = \sum_{i=1}^n R_i x_i \quad (1)$$

Subject to:

$$C = \sum_{k=1}^K C_k \quad (2)$$

$$\sum_{i=1}^n x_i \leq C \quad (3)$$

$$x_i \leq D_i^p \quad i = 1, 2, \dots, n \quad (4)$$

$$x_i \geq 0, \quad i = 1, 2, \dots, n \quad (5)$$

$$x_i - \text{integer variable} \quad (6)$$

$$R_i > R_{i+1} \quad i = 1, 2, \dots, n-1 \quad (7)$$

Where:

$p$  – realization of the reservation process (trip)

$D_i^p$  – total number of received requests for  $i$ -th tariff class at the moment reservation process is closed ( $D_i^p = D_i^p(t_2)$ )

$R_i$  –  $i$ -th tariff value

$x_i$  – number of accepted requests (sold berths) for  $i$ -th tariff class at the moment reservation process is closed

$C_k$  – capacity of  $k$ -th rail car

$C$  – total available capacity.

Each summand in the objective function  $F$  (Eq. 1) represents revenue from berth sale in  $i$ -th tariff class. Total revenue for particular trip  $p$  can be obtained by summing revenue per all tariff classes. The available capacity is a sum of the engaged railcars capacities (Eq. 2). The number of the sold berths maximum can be equal to the capacity of the train (Eq. 3). The number of the sold berths in  $i$ -th tariff class cannot be larger than the number of requests (Eq. 4) for this particular tariff class at the end of the reservation process. The variables  $x_i$  are nonnegative and integer. Solving linear integer programming for each realized transport can ensure the determination of the maximal revenue and adequate number of berths per tariff class. In practice there are two possibilities: the number of requests is smaller or equal to the available capacity and the number of requests is larger than available capacity. In our paper we focus on more complicated, i.e. the second case (Pavković, 2000):

$$\sum_{i=1}^n D_i^p > C \quad (8)$$

In this case some passengers will not be able to buy tickets because the number of the received requests is larger than the available sleeping cars capacity. The optimal number of the tickets sold per each tariff for one trip,  $p$ , can be calculated in the following way (Pavković, 2000):

$$x_i = \max \left\{ \min \left\{ D_i^p, C - \sum_{k=1}^{i-1} D_k^p \right\}, 0 \right\} \quad i = 1, 2, \dots, n \quad (9)$$

According to Eq. (9) it is possible to determine critical class,  $i_p^*$ .

$$x_1 = D_1^p, x_{i_p^*-1} = C - \sum_{k=1}^{i_p^*-1} D_k^p, x_{i_p^*} = 0, \dots, x_n = 0 \quad (10)$$

For each already completed trip, the maximal revenue can be obtained by accepting all requests for berths up to  $i_p^*-1$  th ( $1, 2, \dots, i_p^*-1$ ) tariff class, and some requests for critical class  $i_p^*$ , while requests for other lower tariff classes ( $i_p^*+1, i_p^*+2, \dots, n$ ) must be rejected. Critical time,  $tp^*$ , which starts with rejection of new requests (for tariff class  $i_p^*$ ), can be easily determined using database for trips already completed.

## 2.4 Real time decisions – Artificial Neural Network

Each realization of a rail trip has set of input and output values as shown in Table 1. In total, there are  $P$  tables ( $P$  trip realizations). These sets of input values (obtained by simulation process) and optimal output value (obtained offline by linear integer programming) are further used as training database for the ANN. ANN is used as a tool for decision making in relation to a new request in real time. ANN is technique that relies on a simplified brain model which basically learns from experience. The processing tasks are distributed over numerous neurons (nodes, units or processing elements). Even though individual nodes are capable of simple data processing, the main power of a neural network is the result of connectivity and collective behavior among the nodes (Teodorović and Šelmić, 2012). The inputs to the ANN consist of 6 relevant information e.g. input nodes:

- type of tariff class (first, second or third),
- discrete time interval when request is received (starts from 60 days before journey to one day before journey with increment of 10),
- number of requests per first tariff class (from the past),
- number of requests per second tariff class (from the past),

- number of requests per third tariff class (from the past),
- available capacity (from 6 to 12 sleeping cars, with increment of 2).

For certain inputs related to reservation process, ANN classify new request as accepted or rejected. The input layer has 6 nodes, and output has one nodes. The first layer is input layer, where the data are presented to the neural network. The values of the input variables are numerical values. The intermediate layer is the hidden layer. The third layer is the output layer, representing the network response to the corresponding input. The neural network can then be trained through a training algorithm. Currently, there are a number of training algorithms available for artificial neural network models, and the back-propagation rule, which is one of the most widely used training algorithms, is adopted in this paper.

## 2.5 Payoff table for variable capacity problem

The objective of the decision making process is to determine which decision should be chosen based on the payoff table. Payoff table (or Regret table) generates the payoffs for all combinations of decision alternatives and state of natures. Payoffs can be expressed in terms of profit, cost, time, distance or any other measure. The main goal is the reduction of regretting, so the optimal alternative is the one with the minimum regret.

In a payoff table the conditional opportunity loss (COL) and the expected opportunity loss (EOL) for all alternatives are presented. Expected opportunity loss or expected value of regrets represents the amount by which maximum possible profit will be reduced under various possible strategies. EOL is calculated by multiplying the COL's by associated probabilities and then adding the values. The optimal alternative is the one with the lowest EOL.

In the proposed model, there are two alternatives:  $a_1$  – to increase train capacity, and  $a_2$  – not to increase train capacity. New sleeping cars can be ready (with probability  $z$ ) or not (with probability  $q$  ( $q=1-z$ )) for train departure. We made an assumption that increasing train capacity implies two new wagons more in the composition.

If we choose alternative  $a_1$  (to increase train capacity) there are two outcomes: for the outcome 1 (the new sleeping cars are ready for train departure) there is no regret (COL=0); for the outcome 2 (the new sleeping cars are not ready for train departure) there is certain regret (COL1). For obtaining COL1, we assume that the passengers are entitled to refund for a cancelled train trip. If we choose alternative  $a_2$  (not to increase train capacity) there are two outcomes (Table 2): for the outcome 1 (the new sleeping cars are ready for train departure) there is certain regret (COL2); for the outcome 2 (the new sleeping cars are not ready for train departure) there is no regret (COL=0). COL2 presents the company regrets for non realized profit (lost profit). In the considered example, optimal strategy should be defined as follow  $a_{opt} = \min(EOL1, EOL2)$ .

**Table 2** Payoff table

	COL		EOL	
	$a_1$	$a_2$	$a_1$	$a_2$
Outcome 1 with $z$ probability	0	COL2	0	$z \cdot \text{COL2}$
Outcome 2 with $q$ probability	COL1	0	$q \cdot \text{COL1}$	0
Sum:			$EOL1=0+q \cdot \text{COL1}$	$EOL2=z \cdot \text{COL2}+0$

## 3 Results and discussion

The proposed model is tested on the hypothetical data. Demands for berths reservation are described by normal distribution, while times of reception of the requests are simulated by uniform distribution.

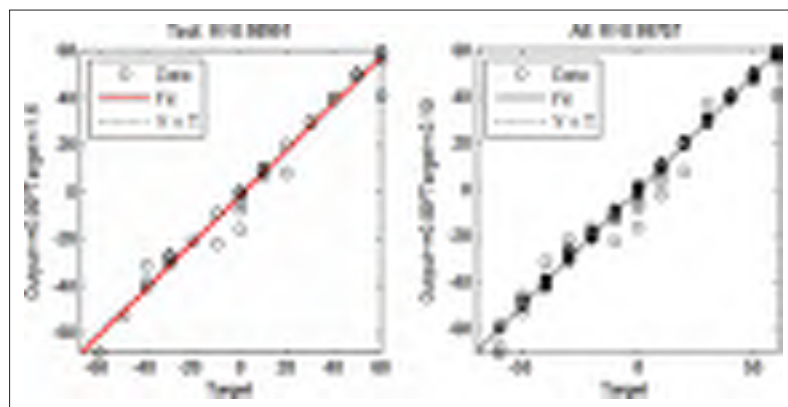


In this paper we assumed that passenger has three possibilities (three different tariff classes) for traveling by sleeping cars: Tourist ticket (passenger buys one regular rail ticket and one berth), Double (one regular rail ticket and two berths) or Single (one regular rail ticket and three berths). Obviously, Tourist ticket represents the cheapest tariff class, while Single is the most expensive one, i.e. the first class. The basic characteristics embedded in the model are:

- All berths are available for all tariff classes, and hence a number of sold tickets in each tariff class are known only after the reservation process being over.
- Demand for seats in all tariff classes is usually a random process.
- Demand is always larger than available capacity.
- In the reservation process, a number of available sleeping cars is not known in advance.
- The first-class tickets are always sold, i.e. all the requests for the first tariff class will be realized.

To estimate the ANN model, there are a number of software packages ready to perform the back-propagation algorithm, and MATLAB was chosen for this study. For the neural network used in this paper, three types of patterns have been taken into consideration (for the neural network training, validation and testing).

We have simulated data for 100 realizations. In total it is 8400 input and output data for ANN. For each realization we form table with 84 rows. During the training phase, the ANN has optimally classified a new passenger request as accepted or rejected in 99% of cases. When the test data were processed, an accurate matching was also 99% in all cases. The regression in the case of training, test, validation and all data is shown in Figure 2 where the x-axis shows the target values, while the y-axis shows the output values.



**Figure 2** The matching of the output data to the target results (relation between the output data and the target results)

During reservation process rail operator could face with lack of available train capacity. Then it is necessary to make the decision about new sleeping car's engagement. To make appropriate decision conditional values – COL should be multiplied by certain probabilities, and then obtained expected values should be summarized and compared. By comparison of these two values, the optimal alternative is defined.

## 4 Conclusion

This paper presents the application of Revenue Management concept for capacity allocation in railway industry. The proposed model is a decision support model developed for making real time decisions about accepting or rejecting new passenger request in rail transport. It

is applicable for the issues with variable capacity. The proposed model, based on Artificial Neural Network and Payoff table, takes into account variable capacity of trains, and the uncertainty of rail car preparedness. The algorithm is tested on hypothetical data. The obtained results show great applicability of the model. Future research will consider rail network with multi-leg itinerary.

## References

- [1] Armstrong, A., Meissner, J.: Railway Revenue Management: Overview and Models, Working Paper, Lancaster University Management School, 2010.
- [2] Bharill, R., Rangaraj, N.: "Revenue management in railway operations: a study of the Rajdhani Express, Indian Railways Rajdhani Express, Indian Railways", *Transportation Research Part A: Policy and Practice*, 42 (2008) 9, pp. 1195-1207.
- [3] Campbell, K.: Booking and revenue management for rail intermodal services, Ph.D. dissertation, University of Pennsylvania, Philadelphia, PA, 1996.
- [4] Teodorović, D., Šelmić, M.: Computational intelligence in transport. Faculty of Transport and Traffic Engineering, Belgrade, 2012.
- [5] Pavković, G.: Intelligent Airline Seat Inventory Control System. Ph.D. dissertation, University of Belgrade, Serbia (In Serbian), 2000.
- [6] Teodorović, D., Lučić, P.: "Intelligent parking systems", *European Journal of Operational Research*, 175, pp. 1666–1681, 2006.
- [7] Teodorović, D., Popović, J., Pavković, G., Kikuchici, S.: "Intelligent Airline Seat Inventory Control System", *Transportation Planning and Technology*, 25, pp. 155-173, 2002.





## FUNCTIONAL CONNECTING OF THE RAILWAY BYPASS AROUND NIŠ AND THE RAILWAY JUNCTION NIŠ

Tatjana Mikić<sup>1</sup>, Dragan Djordjević<sup>2</sup>

<sup>1</sup> CeS COWI d.o.o., Serbia

<sup>2</sup> Institute of Transportation CIP, Serbia

### Abstract

This paper presents functional connecting of the railway bypass around Niš and the railway junction Niš. Railway infrastructure in the city of Niš consists of two main railway lines Belgrade – Niš – Preševo – state border (E-85 and E-70) and Niš – Dimitrovgrad – state border (E-70) and one regional railway line (Niš) – Crveni Krst – Zaječar – Prahovo Pristanište. Within the junction, connections are made by railway lines which are the parts of main directions E-85 and E-70: Crveni Krst – Niš Marshalling, (Crveni Krst) – (Čele Kula), Trupale – Niš Marshalling – Medjurovo, Niš – (Niš Marshalling). The traffic issue is for the city of Niš on one hand – the limiting factor, and on the other hand – stimulating factor of development. Functionality of railway traffic in the city, in addition its' basic function, need to have a positive effect to meet the needs of citizens' mobility. Reduction of collision points "city – railways" should correspond to the strategy of the city development, previously planned and defined. In the city centre, a huge problem of level crossings exists. In the present situation, running of freight trains through the central zone of the city produces increased levels of pollution and noise, and increases risk of environmental pollution, due to the passing of dangerous goods through the town. Construction of the railway bypass is one of the phases of solving traffic problems in Nis, and by its construction following will be achieved:

- The separation of the railway line and roads in the city area, the separation of passenger and freight traffic in the urban area and the separation of transit from local traffic;
- Harmonization of transport infrastructure development with city's development and development of the airport "Constantine the Great" in Niš;
- Development of railway facilities without disruption of transit traffic on Corridor X by local works.

*Keywords: railway junction, traffic organization, functionality of the station, traffic flows, technological effects*

### 1 Introduction

For designing of the railway bypass, existing century-old railway corridors and railway land, previously planned corridors for the railway, and railway capacities on existing locations and their integration in a new technical – technological solution, all according to urban and spatial plans, were maximally used. Construction of the railway bypass is planned in the Alignment of the Corridor X. On the international railway network, Niš is the common connection point of two international traffic directions, actually main railway lines according to AGC Agreement. Main railway line E-85 is Budapest – Subotica – Belgrade – Niš – Skopje – Athens and main railway line E-70 is Paris – Turin – Sežana – Ljubljana – Zagreb – Belgrade – Niš – Sofia. It is

about the construction electrified, single-track railway bypass around Niš for the speed up to 160 km/h, in length of approximately 20 km.

Due to the equal participation of Serbian railway traffic on the single European market, it is necessary to harmonization of all elements of conventional railways in our country with the standards and regulations of the European Union. To facilitate the flow of goods and passengers it is necessary to establish mutual connection, harmonization of technical standards, the characteristics of the infrastructure and rolling stock, efficient connection between information and communication systems, the application of interoperability in national railway networks. Accession to membership of UIC and CER, and the decision of the state to initiate activities as planned accession to the EU, implies a clear defined obligations concerning the harmonization of national regulations and standards with those in force for the EU member states and member of railway organizations UIC and CER.

## 2 Overview of the existing railway framework

The starting point in the approach to solving the railway bypass is the retention of the entire existing circular ring of Niš railway junction. Referent model was defined on the existing railway network, without previous reconfiguration of railway junction. The referent model of junction includes common elements from existing railway junction and constructive elements for the construction of railway bypass, and it is shown on the Figure 1.



Figure 1 Referent model of the junction Niš.

## 3 Main technological requirements for the railway bypass and establishments

The railway bypass should be designed according to AGC, AGTC, European Technical specification for Interoperability TSI and SEECF Agreement in common rail-road Corridor X.

- Separation of freight and passenger trains on the approaches to the city, and relieve the central city zone of the freight traffic.
- Direct traffic of passenger trains on the main lines through the station Niš without changing the operational direction of the trains and head of trains, and no change of type of traction.

- Functional and rational solution of the railway bypass, the railway station on the bypass and connections between new bypass line and existing infrastructure capacities. Keeping the existing and planned connections between the industry and railways.
- Maximum speed on railway bypass is adapted to the terrain conditions and urbanized city area.
- Safe traffic of all types of trains which are operating with different speeds.
- Providing the Centralized Traffic Control (CTC), Automatic Train Control (ATC) and Automatic Train Protection (ATP); Installation of the ETCS Level 1 system as an overlay to the basic interlocking system.
- New open line sections will be equipped with electronic centralized single-track automatic line block system with axle counters for occupancy control of block sections.
- Installation of the GSM-R network, which would be at this stage used for the transmission of voice, with the possibility of later modification for signalling data transmission. Planning all telecommunication systems to guarantee interoperability and all links for interlocking systems.
- Traffic management could be provided by manned establishments and also by tele control centre at Niš. Foreseen capacities that will provide the inclusion of stations on the railway bypass into the tele control system.
- The stations shall be designed in compliance with European standards (AGC/TSI standards), with track connections which allowed reception and departure of trains of all station tracks; Usable length of relief tracks is 650- 750 m.
- Platforms and underpasses shall be designed in accordance to TSI PMR.
- Station buildings are designed to provide all necessary premises for traffic services, as well as premises for official staff and equipment.

#### 4 Identification of the functional characteristics of the railway bypass and the functional tasks of the establishments for the new junction configuration

The main existing junction stations Niš Marshalling, Niš and Crveni Krst retain their operational function for passenger railway traffic and for servicing of industrial tracks. Connections of the Junction Niš with the new railway bypass are realized at the station Niš Marshalling, Crveni Krst and Trupale. Connection of the railway bypass with existing, but reconstructed railway lines, will be performed at: new station Niš Sever, new station Pantelej, new junction point "Prosek".

- **Station Niš** is the main passenger station in the junction, and also a diverge station. It is opened to provide all services in international and domestic passenger traffic
- **Station Niš Marshalling** is the main shunting station in the junction, and also a diverge station for freight trains.
- **Station Crveni Krst:** The main technological task of the station Crveni Krst is regulation of railway traffic on main lines E-85 and E-70 and separation of railway line for urban transport.
- **Station Trupale:** The main technological task of the station Trupale is regulation of railway traffic and separation of passenger and freight traffic towards Skopje.
- **New station Niš Sever:** The station Niš Sever is the intermediate (transit) station, where three railway lines are branched and intersected. Vicinity of the airport and marshalling yard, and the further development of industrial zones of this area, place the station Niš Sever in a position to be established and transformed into a cargo transportation centre. Its neighbouring stations are Trupale, Niš Marshalling, Crveni Krst and Pantelej. The main technological task of the station Niš Sever is regulation of railway traffic on lines: Belgrade – Mladenovac – Niš – Preševo – state border (section Trupale – Crveni Krst) and Niš Marshalling – Crveni Krst, and on railway bypass (section Niš Marshalling – Pantelej). The entrance to station Niš Sever from one side is provided for two directions: Niš Marshalling and Trupale (for exi-

sting track and future second track of railway line Belgrade – Niš), and from the other side for three directions: Crveni Krst – Trupale, Crveni Krst – Niš Marshalling and from Pantelej (Dimitrovgrad). For passenger trains Niš Sever will be opened for suburban, local and urban passenger services for direction Niš – Belgrade. International passenger trains and domestic trains from Dimitrovgrad and Zaječar would not pass through this station.

- **New station Pantelej:** The station Pantelej is the intermediate station in terms of traffic, where two railway lines are separated and intersected. Its neighbouring stations are Niš Sever, Crveni Krst, Matejevac and Vrežina. The main technological task of the station Pantelej is regulation of railway traffic on lines: Niš – Dimitrovgrad – state border (section Crveni Krst – Vrežina) and (Niš) – Crveni Krst – Zaječar – Prahovo Pristanište (section Crveni Krst – Matejevac). The separation of direction for Dimitrovgrad and Zaječar will be performed at the station Pantelej. The entrance to station Pantelej from one side is provided for two directions: from Niš Sever and Crveni Krst for railway line (Niš) – Crveni Krst – Zaječar – Prahovo Pristanište, and from the other side for two directions: from Matejevac and Vrežina. For passenger trains Pantelej will be opened for suburban, local and urban passenger services. Station would not be open for work with goods (freight). Station Pantelej is passing station for international passenger trains and for all freight trains.
- **New station Vrežina:** The new station Vrežina on the bypass line will have primary the turnout function, due to increase of the railway bypass line capacity. Its neighbouring stations are Pantelej and Sićevo. The main technological task of the station Vrežina is regulation of the train traffic on main line Niš – Dimitrovgrad – state border. The entrance to station Vrežina from one side is provided direction Pantelej, and from the other side for direction Sićevo (Dimitrovgrad). For passenger trains Vrežina will be opened for suburban, local and urban passenger services. Would not be open for work with goods.
- **New establishment (junction point) Prosek:** In order to connect the new railway bypass and existing railway line Niš – Dimitrovgrad – state border, there is planned a construction of new establishment Junction Point “Prosek”. Control safety and handling of devices will be performed from the station Vrežina. Connection of railway bypass with the railway line Niš – Dimitrovgrad will be temporary performed by the junction “Prosek”, and it will be removed after the completion of the modernization of the railway line Niš – Dimitrovgrad.



Figure 2 Proposed location and layout of the railway bypass line.

## 5 Assessment of traffic flows distribution for the new junction configuration

The construction and functioning of the railway bypass are directly related to the reconstruction and functionality of five existing railway lines in the junction.

Functional connection of railway bypass and the railway junction Niš will establish new traffic flows in the node. The greatest effects of bypass construction will be reflected in the transit freight traffic through the increased speed of the trains, reducing travelling time and shortening the time of execution of technological operations. Traffic organization in conditions of the newly built bypass and electrified railway line Niš – Dimitrovgrad will allow direct transit traffic through the node without changing the direction of movement and traction, reducing the number of shunting movements and reducing the number of technological operations that are performed on certain types of trains, thus reducing the harmful effects of pollution and noise, increasing road safety and eliminating number of level crossings in the city centre. New railway traffic organization, after bypass construction, is based on following:

- All predicted technological operations with passenger and freight trains, based on defined technological tasks of station, are performed with optimal usage of existing capacities at stations Niš, Niš Marshalling and Crveni Krst
- Shunting work is concentrated at the station Niš Marshalling, into which all connecting railway lines enter, and where all flows of wagons in the node are processed. Niš Marshalling is the terminus station for freight trains which are not transit the node.
- Station Niš is the main passenger terminal together with the bus station for the City of Niš, for remote and suburban passenger traffic. All categories of passenger trains have to stop at the station Niš
- All existing industrial tracks, which are the connection of railways and industry, are retained at the station Crveni Krst, where the servicing of these tracks is organized and performed.
- Establishments, railway lines and connections of tracks allow direct train traffic from Belgrade towards Sofia and Skopje without changing the head of train. For suburban traffic, the traffic of trains from all directions is allowed through the junction.

New organization of traffic flows through the junction, in conditions of the railway bypass built is shown on the Figure 3.

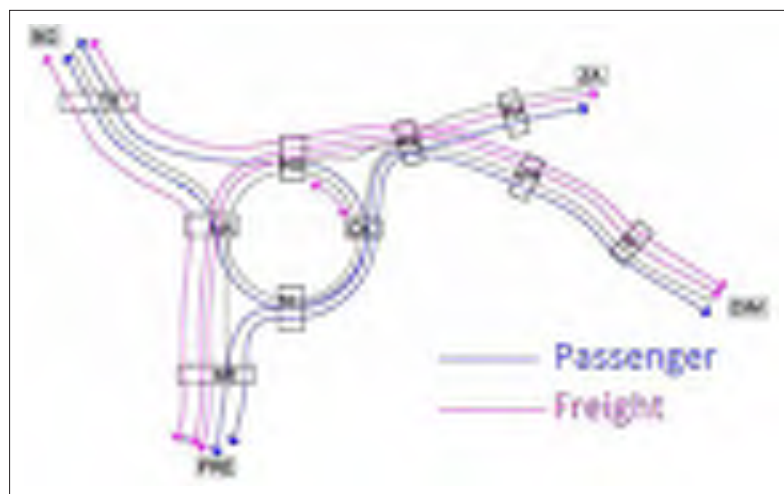


Figure 3 Passenger and freight flows in conditions of the railway bypass built.



All foreseen technological tasks will be performed with existing capacities at stations: Niš, Niš Marshalling, Crveni Krst, Trupale and Sićevo. Capacities of stations on the new railway bypass in the first phase of the railway bypass construction, were entered and checked in the simulation software package – Open Track.

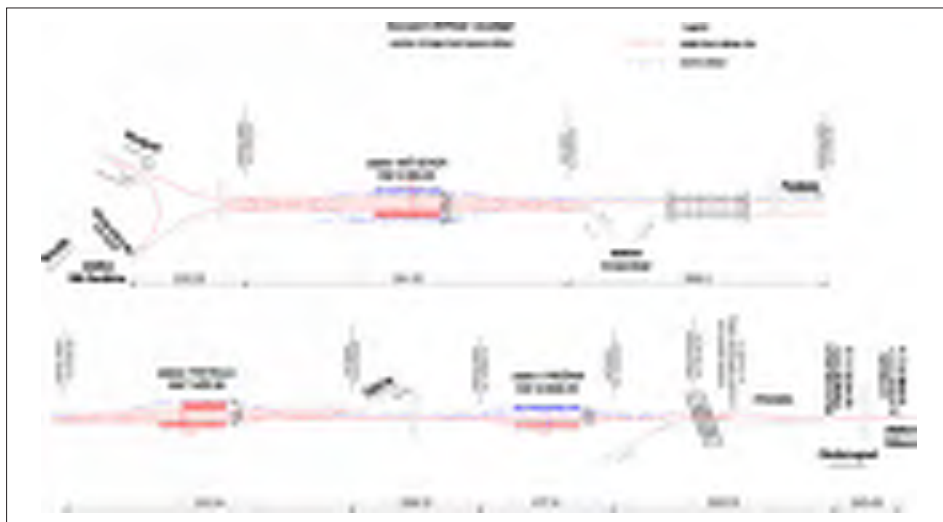


Figure 4 Display of capacities in new station on the railway bypass.

## 6 Technological effects of the railway bypass construction

### 6.1 Travelling time

Different categories of trains can operate:

- on the whole train path via the railway bypass,
- Through one of its parts in combination with other railway lines, depending on a given routing.

Over the whole railway bypass freight trains operate with  $V_{max}=70 - 100$  km/h. Travelling time for those trains is  $t_t^f=19$  min in direction Niš Marshalling – Niš Sever – Pantelej – Vrežina – Sićevo, and  $t_t^{f2}=20$  min in the opposite direction. Dealing with freight trains in stations depends on the type of freight train and anticipated technological operations on them.

Passenger trains operate with  $V_{max}=70 - 160$  km/h via the section Pantelej – Sićevo. Travelling time for international trains is  $t_t^{ip}=9$  min in both directions, and for domestic trains  $t_t^{dp1}=11$  min in direction (Niš – Crveni Krst) – Pantelej – Vrežina – Sićevo and  $t_t^{dp2}=12$  min in the opposite direction.

### 6.2 Analysis of transport capacity

Two scenarios were considered for evaluation of transportation capacity of the railway bypass. In both scenarios observation of the capacity utilization was performed. Scenario 1 considers the situation on the basis of the Time table 2014/15. Scenario 2 considers presumed level of service in passenger traffic. Scenario 2 offers certain services in international and domestic passenger traffic, and after the determination of passenger routes, the railway bypass would be loaded with much more cargo traffic, in order to comprehend the restrictions in stations and on the open line. Following station capacities on the railway bypass are used in the analysis:

- Niš Sever – tracks No: 2, 3, 4 and 5,
- Pantelej – tracks No: 1, 2, 3 and 4,
- Vrežina – tracks No: 1 and 2.

### Scenario 1

Routing for all passenger and freight trains, that are planned in Time table 2014/15, was changed and routed the new ones, via the railway bypass. In simulation, departure time of trains from key stations in the junction Nis (Nis, Nis Marshalling and Crveni Krst) is retained, as well as transit time of trains through “border junction” station (Trupale, Medjurovo Matejevac and Sićevo). The obtained results are presented in graphs timetable.

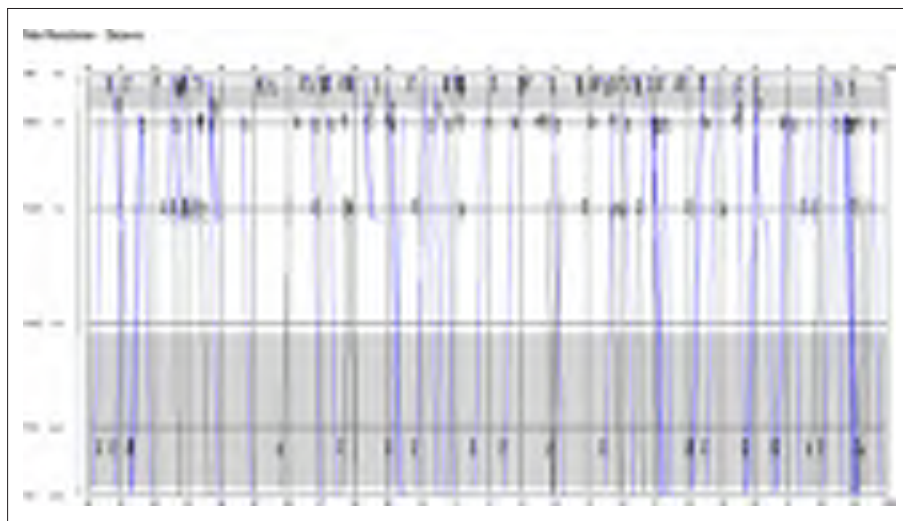


Figure 5 Time table for railway section Niš Marshalling – Sićevo: Scenario 1.

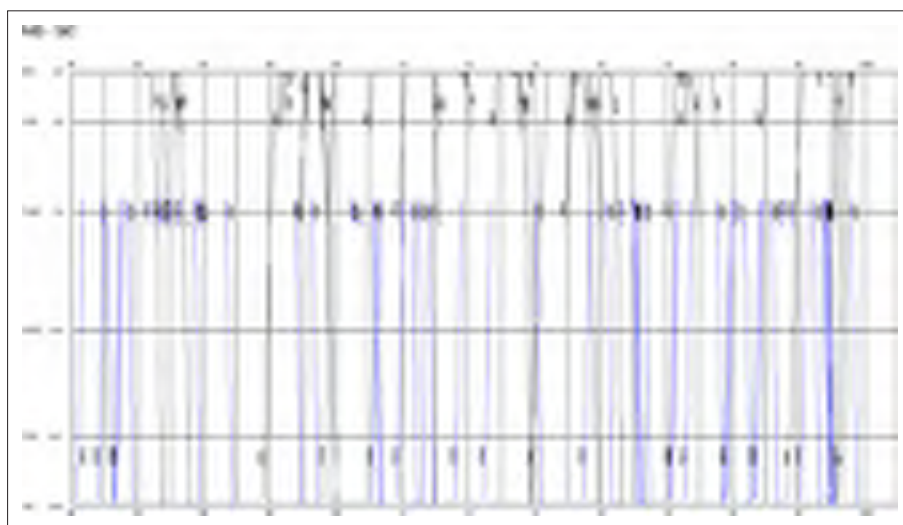


Figure 6 Time table for railway section Niš – Sićevo: Scenario 1.

## Scenario 2

The regime of passenger traffic proposed is based on the assumption of timetable with the same time gaps for departures of trains from stations Niš and arrivals at the station Niš, and on the following:

- The passenger traffic in period from 05:00 h to 23:00 h,
- For direction Belgrade – Dimitrovgrad: 6 pairs of trains, 1 pair every 3 hours, and for direction Belgrade – Preševo: 5 pairs of trains, 1 pair every 4 hours,
- Domestic passenger traffic, one pair of trains every hour in peak period and off-peak period one pair of trains every 2 hours in all directions (12 pairs of trains).

For directions Belgrade – Dimitrovgrad and Niš Marshalling – Dimitrovgrad, train paths for freight trains are planned at an interval of half an hour, and for direction Dimitrovgrad – Preševo at an interval of one hour.

In order to avoid disruptions in passenger traffic, individual train paths of freight trains have been “removed”, and the total number of freight train paths in the simulation model is 96. The obtained results are presented in graphs timetable.

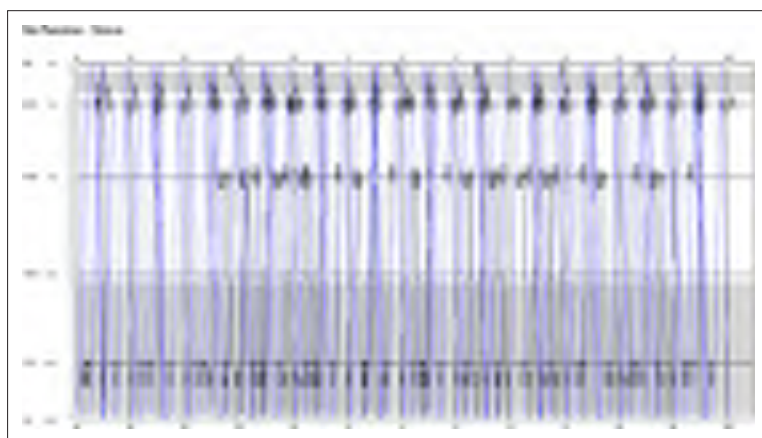


Figure 7 Time table for railway section Niš Marshalling – Sićevo: Scenario 2.

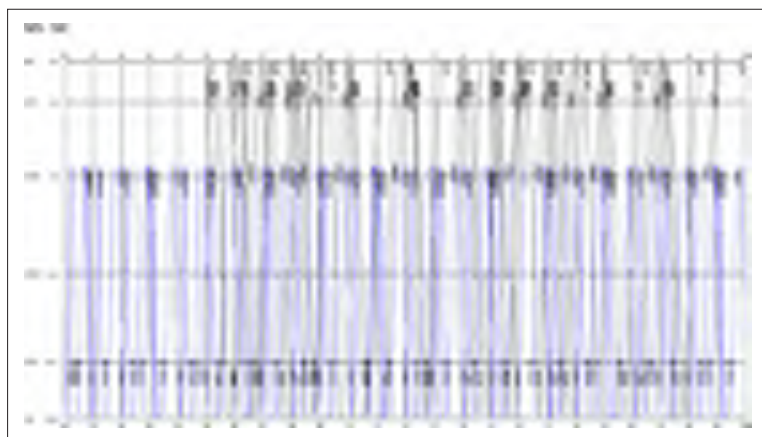


Figure 8 Time table for railway section Niš – Sićevo: Scenario 2.

### 6.3 Line capacity for the railway bypass

Theoretical line capacity was calculated on the basis of following conditions and parameters:

- Scenario 1 based on the Time table 2014/2015, Scenario 2 based on assumed volume of traffic and proposed passenger service,
- Train categories are: I – international passenger trains, II freight trains, III – local passenger trains,
- Number of influence of interstation distance is 5,
- Ruling section is Vrežina – Sićevo.

Results of the theoretical line capacity:

- Average headway of trains on the ruling section is 8,6 min.
- For period 24 h / 1440 min, 93 trains with capacity utilisation of 58,84%,
- For period 22 h / 1320 min, 86 trains with capacity utilisation 64,19%,
- Capacity utilisation in Scenario 2 is very high, close to 100%, and indicates the necessary changes in traffic organization.
- Realised traffic in Scenario 2 for 1440 min is 142 trains.

The observed scenarios are some of possible, and it can surely give a good representation of what can be expected when performing traffic over the railway bypass. For the real usage of the line capacity, for designers of the Timetable is essential to determine the additional time in order to ensure the quality of the Timetable execution. The theoretical calculation leaves the door for traffic on the railway bypass according to the scenarios that are considered, but does not apply to the whole railway line Niš-Dimitrovgrad, which has its own ruling section, which was not the subject of this project.

## 7 Conclusion and further recommendations

Proposed measures to further optimization of existing capacities and traffic organization after the construction of railway bypass are:

- Providing of at least one transit track at the station Nis Marshalling for international passenger trains running on direction Belgrade – Dimitrovgrad;
- Further development of the station Niš Sever in terms of freight station, which provides conditions for the relocation of the loading – unloading from the stations at the Niš junction
- Connection of industrial tracks at the station Crveni Krst with the station Niš Sever as the future freight station;
- On the section Niš – Sićevo of existing railway line Niš – Dimitrovgrad, after construction of bypass, conditions will be met for the elimination of 16 level crossings. The alignment from the station Niš to the station Čele Kula could be used in function of urban passenger traffic.

## References

- [1] “Spatial Plan for the administrative area of the city of Niš 2021”
- [2] “European Agreement on main international railway lines” AGC, done at Geneva on 31 May 1985, “European Agreement on important combined transport lines and related installations”, done at Geneva on 01 February 1991
- [3] Mikić, T.: “General Design Construction of a single track railway bypass around Nis – Traffic and technology study – Functional and Operational Design”, CeS COWI d.o.o., Belgrade, Serbia 2014.
- [4] Directive 2001/16/EC “Interoperability of Pan-European the Conventional Rail”; Directive on the interoperability of the railways in the community (RAIL) 2008/57/EC.
- [5] Time table of Serbian Railways, 2014/15.

- [6] UIC Code 140 “Accessibility to stations in Europe” and UIC 413 “Measures to facilitate travel by rail” from January 2008.
- [7] Simić, T., Mikić, T.: “Traffic-constructional aspects for building of bypass around Niš in Corridor X”, 3<sup>rd</sup> International Conference on Road and Rail Infrastructure – CETRA 2014, Croatia, 28-30 April 2014.
- [8] UIC Code 406 from June 2004 and UIC Code 451-1 from December 2000



## INTELLIGENT INFRASTRUCTURE AND ITS USE IN MONITORING AND REGULATION OF ROAD TRAFFIC

Abidin Deljanin, Fadila Kiso, Emir Deljanin

*University of Sarajevo, Faculty of traffic and communications, B&H*

### Abstract

The expression “Intelligent Infrastructure” presents devices and systems which are used with intelligent transport systems and systems for management of traffic. Intelligent Infrastructure presents purposeful organizational and informational – communicative upgrading of classical traffic systems, vehicles and transport entities. Basic role of Intelligent Infrastructure is reflected in information gathering, elaboration and analysis of current status, and on that bases orders are issued in order to provide simple activities flow for all traffic participants in a traffic process. Due to the complexity and the compactness of the term intelligent infrastructure it is necessary to base the division on the devices and objects of Intelligent Infrastructure. The Intelligent Infrastructure devices includes: sensors, detectors and variable traffic signs, while the objects of Intelligent Infrastructure imply the toll booth, intelligent vehicles and intelligent infrastructure in the tunnels. The sensors and detectors are the main technical components of Intelligent Infrastructure that are providing collection of data from “system sources” which includes capability to collect and elaborate data’s of Intelligent Infrastructure environment. Variable traffic signs are signs that can change their content due to the different needs, but due to the traffic flow on first place. The application of these complex assets is applicable in the entire transportation system and its application has led to greater safety and security of all traffic participants, a better traffic flow on the roads, reducing congestion and traffic jams, more efficient monitoring and control system.

*Keywords: Intelligent infrastructure, monitoring, regulation, road traffic*

### 1 Intelligent Infrastructure communication system in road traffic

Nowadays there are more data transfer technology that is characterized by different parameters such as transmission speed, reliability, flexibility, security and quality of service. Some of these technologies have their place in both fixed as well as mobile and satellite networks. Highways are equipped with information and communication systems. In parallel with the intensive construction of modern, ie, intelligent infrastructure is being built as a information and communication systems which are provided for the control and management on roads [1]. The systems that are used for collecting traffic data, measurements, adaptive control, and traffic signalization are seen as part of intelligent infrastructure on highways. The telecommunications system enables the exchange of data, speech and video between users and centers for traffic management. Globalization and the rapid development of information technology, contributes to the increasing volume and it is needed by the users for broadband data, voice and video services. With advantages such as rapid network construction and fast return on investment, broadband wireless access systems, represent one of the most acceptable solution operators to build a MAN (Metropolitan Area Network). To achieve maximum effect in the monitoring, management and thus improving the overall traffic on the roads it is necessary

to enable communication between vehicles and intelligent infrastructures. The importance of communication within vehicle-to-infrastructure is reflected in the fact that the vehicle receiving information about changes in the position of neighboring vehicles (accidents, overtaking and other maneuvers on the road) are able to adequately respond to the same, in terms of avoiding new traffic accidents [2].

### 1.1 The importance and the role of intelligent infrastructure in the management and safety systems in road traffic environment

Solving the problem of traffic using the information – communication technology has proven to be a very effective way to increase the flow, stabilizing traffic flow, increase safety and driver awareness. Traffic lights with pre-coordinated time for a long period has been a solution that has worked successfully. Enormous increase in motorization and uneven load of road congestion, traffic queue and traffic jams are still present. In the regulation of traffic systems we have involved certain amount of speed and movement detectors of road vehicles, especially sensors, which can analyze the situation on the roads and measure the speed of individual vehicles on the basis to regulate the of speed traffic flows. Traffic flow is displayed in three basic sizes as follows: the flow of vehicles, current density and high space velocity. The values of this parameter indicates what type of traffic flow is in question (free, normal, saturated and forced). The fundamental equations of the theory of traffic flow is:

$$q = g \cdot v_s \text{ (veh/h)} \quad (1)$$

Where:

- q – the flow of vehicles [veh/h];
- g – density flow [train/km];
- $v_s$  – average spatial speed [km/h].

The principle operation of detector traffic signalization lights is to electronically register frequencies of traffic and controlled regulation of green light to allow better flow of vehicles. The main advantage of the new management system is the greater flexibility of programmed signal interval, which means less time losses for vehicles waiting for a green signal. There are three types of such traffic lights, which are programmed depending on the type of intersection that is managed. In addition the detectors and sensors without analyzers and process units have no purpose. Processor control is realized through three concepts [4]. The first concept is based on the detection of vehicles to give absolute priority, where the vehicle with priority passage, such as emergency vehicles or trams, gets a solid green light, and the other participants red signal. The second concept is the intersection of the main and sub lines, the main line has a much higher traffic load and if obtained information that there is no vehicle from the side direction of getting the green light. The third concept occurs in the case when both directions around burdened number of vehicles. At these intersections are installed detectors in order to extend the duration of the green light. Work is based on the principle that every three seconds there is a control if a vehicle is arriving. If the camera detects a vehicle from a lateral direction interruption phase intended for the passage of vehicles. The benefit of radar devices is that messages can change the content and warn road users about the weather, the state of road, accidents, road works and the permitted speed of the vehicle.

They are used both in the urban and the rural roads and the roads of the highest rank, ie. highways. The problem of these devices is that the detectors and sensors are sensitive devices that are susceptible to interference and external influences. Additionally still require significant financial resources for the purchase and maintenance. The efficacy, safety, reliability are the keywords today for assessment of traffic transport management systems. Increasing mobility and the degree of motorization led to imbalances or the state of increasing demands



on network capacities. The result of the congestion in the network to which it is now estimated that the relationship of 2 to 4% of GDP per year in Europe [9]. As a result, one of the imperatives is better, and safer traffic management in the network of existing roads [5].

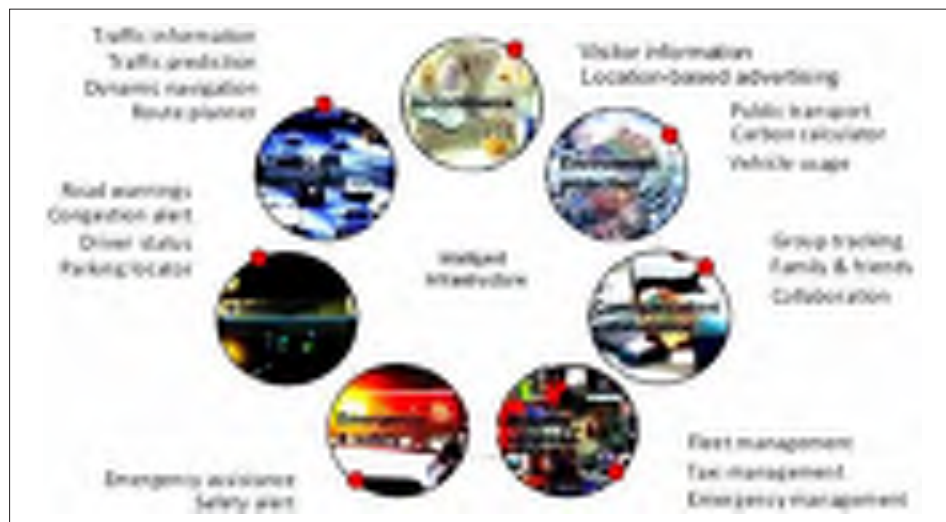


Figure 1 Display of the basic services that ITS provides in the management of road traffic [4]

The results so far in the application and estimates suggest that intelligent infrastructure will be one of the main tools in achieving better, more efficient, safer traffic conditions on the road networks. Keywords such as efficiency, safety, environment, lower maintenance costs are almost always present in the presentation of certain system of intelligent infrastructure but some doubt remains when one takes into account the structure of algorithms which provide certain management decisions. Progress in terms of utilization of the opportunities provided by Intelligent Infrastructure in practice are very small. Dynamic traffic management is almost not applied in practice. The study of user behavior, accepting or not the information that his offered, acceptable intervals tracking, user behavior in conditions of congestion, travel time-haul flow and others. Research in these areas are very modest and therefore the results. For example relation flow-rate as a function of the characteristics of urban roads are usually taken from existing manuals or instructions that are made in other conditions and in other times. A large degree of safety of road transport today is the goal of many countries. Developed countries are investing heavily in infrastructure and sophisticated equipment. Countries in transition, however, due to lack of investment in existing facilities, and in fact usually clenched increase in the number of vehicles (mostly elderly), complicate the problem of road traffic. The solution probably lies in greater involvement and commitment to traffic not only participants in traffic, but also the whole society. Therefore, road traffic daily corrects and marginalize various regulations and laws. Devices of Intelligent Infrastructure largely correct the use that can affect the change of the safety state of road traffic systems. Although their safety of road transport is not fundamental role in ultimately having a significant contribution to increase the level of safety in road traffic systems. A precondition for this is the connection with the center that aims to rationally manage the traffic and its control. Management of traffic trying to avoid traffic jams, congestion, the appearance of the column of vehicles and other elements that disrupt traffic stability and security. General-known rule says that constant control causes cautionary behavior to drivers and the participants in the traffic so that these appliances such as speed control can contribute to the greater safety of road traffic. An example of application and use of sensors is possible in almost all engineering and many other fields, Figure 2.



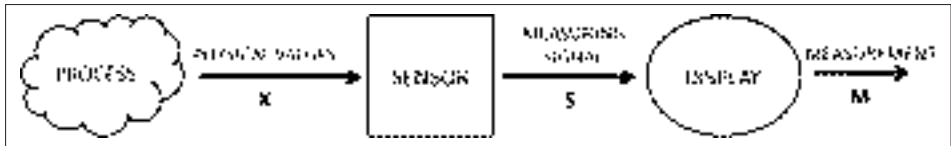


Figure 2 A simple model of instrumentation sensors [4]

Based on the size of the X sensor generates a signal S which can be manipulated in a manner:

- 1) Display on a visual unit,
- 2) To carry out treatment,
- 3) Transfer to certain distance.

Calibration or static characteristics of the sensor is a relation between physical value X and the measurement signal S. The sensor can be calibrated by bringing his input the elements who are a set of known values in the physical value and recording the response to it. In case of additional sensor inputs, interfering input response of the sensor represents a linear combination of the interference input and the measured physical value, shown mathematically and graphically on the chart below, Figure 3.

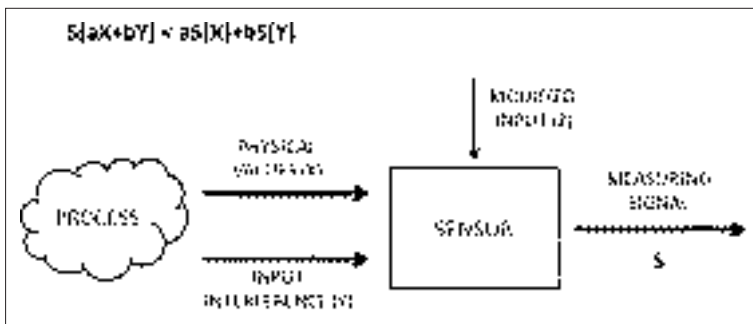


Figure 3 Schematic sensor with modifying entrance [4]

From the point where the sensor is placed it depends his efficiency and maintenance costs. The sensors (the same applies to the detectors) placed on or in the street, are more susceptible to defects than those set above the road. On the choice of where the impact properties of roads, technical limitations and the type of management on the crossroads. There is no country in the world that does not have the problem of traffic safety. But when it comes to our country B&H it should be noted that we are leading in Europe by the number of accidents and fatalities. Despite the planned measures and new stricter legal provisions still did not achieve the desired effect.

## 2 Application of intelligent infrastructure in the actual surrounding

Intelligent Infrastructure together with ITS is a new discipline that certainly provides a more efficient and safer traffic, and the better use of existing infrastructure, but not always. Today's use of intelligence in road traffic is very tight and difficult to fully digest.

### 2.1 City traffic control

The population is steadily increasing worldwide resulting in intractable traffic congestion in dense urban areas. Consequently the demand for mobility is increasing, resulting in severe traffic congestion in urban areas. Traffic congestion leads to undesirable impacts on mobility,

accessibility and socio-economic activities, as well as the environment. Another important form of monitoring of traffic is video surveillance. Currently, video surveillance is used manually by the operator in the control center that collects information automatically coming from the detector. There is great interest in automated data collection.

## 2.2 The system that controls the management of traffic

Adaptive Traffic Signal Control (ATSC) has the potential to effectively alleviate urban traffic congestion by adjusting the signal timing plans in real time in response to traffic fluctuations to achieve the desired objectives (e.g. minimising delay). For small and medium flows, the system compares the advantages and disadvantages of the change in the next phase and does change when it is needed the most. Reinforcement Learning (RL) has shown promising potential for self-learning ATSC due to its ability to perpetually learn and improve the service (traffic conditions) over time. In RL, a traffic signal represents a control agent that interacts with the traffic environment in a closed-loop system to achieve the optimal mapping between the environment's traffic state and the corresponding optimal control action, offering an optimal control policy. The agent iteratively receives feedback reward for the actions taken and adjusts the policy until it converges to the optimal control policy. Once the optimal policy is learned, the mapping of the observed system states to the optimal control actions is very fast. For a network with multiple signalised intersections, efficient and robust controllers can be designed using a multi-agent reinforcement learning (MARL) approach. This system provides a high degree of flexibility because it is oriented to the group (not on stage), and contains several new features that make heavy traffic safer, reduce congestion and give priority to public transport.

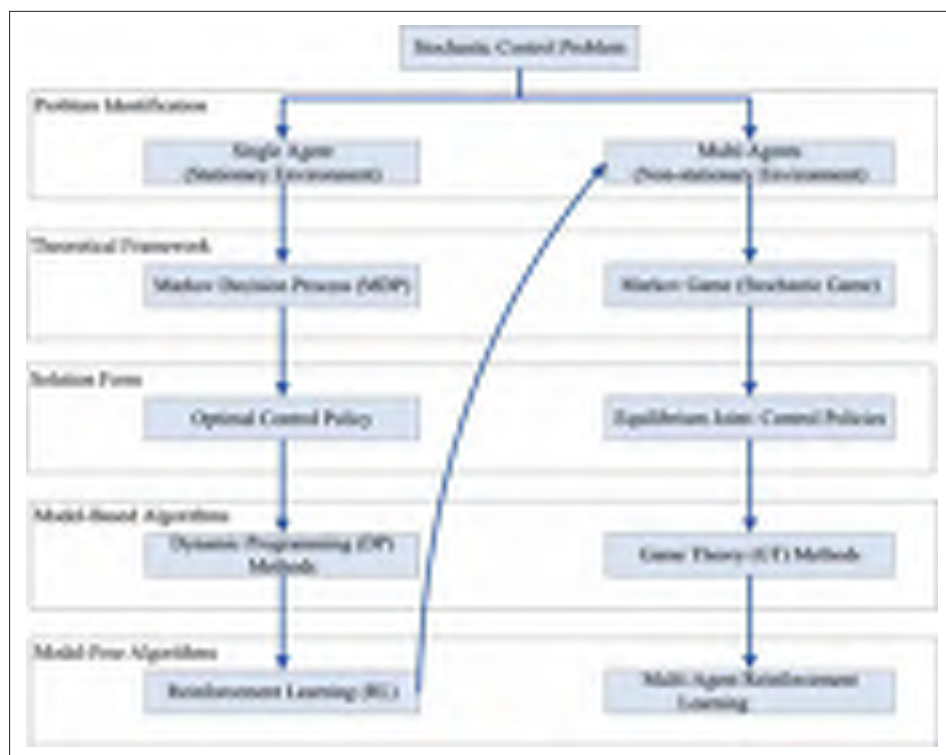


Figure 4 Stochastic control problem [9]

In order to solve the ATSC problem in general, and to particularly facilitate the understanding of the proposed approach in this paper, the problem first has to be properly classified and formulated. Due to the stochastic nature of the traffic environment, ATSC can be classified as a stochastic control problem, Figure 4. This paper provides the relevant theoretical foundation for this type of control problem from single agent and multi-agent perspectives. It also provides a review of RL as a promising solution algorithm for the stochastic control problem. The problem of coordinated ATSC is a challenging due to the exponential growth in the number of joint timing plans to be explored as the network size grows. This thesis focused on the development of self-learning-based approaches to coordinate the behaviour of control agents in a multi-agent traffic control system with an emphasis on decentralised and scalable methods for large-scale urban traffic networks. Achieving coordination between agents in GT is proven to be unfeasible for a large number of players (agents) because the state-action space increases exponentially and the learning speed decreases dramatically with the number of agents in the system, which is known as the curse of dimensionality problem.

### 2.3 Highways control

This refers to traffic control and tunnels, outside urban areas and includes the detection of accidents, monitoring the load, entry and exit from the highway and follow collective travel guide. The changing display messages “Variable Message Signs” (VMS) can be used to determine the speed and direction (as in” Dutch Motorway Control and Signaling System “(MCSS), so that warns drivers about the state ahead of them or to make recommendations on the selection of direction (as in the Rhein / Main motorway network). It is important to distinguish between “access” control (mandatory access control) and “line” control (required control speed and direction). For sizing station toll is possible to use analytical formula. If these formulas and / or methods do not provide an appropriate solution must not come to a state of supersaturation. Simulation methods are required to analyze the existing station for toll collection (simple and complex – in terms of sizing), in which the combined bidding toll (e + manually) [10]. Classical systems charge fees for the use of road infrastructure are very difficult to apply in countries with a high volume of vehicles, because they require interruption of traffic flow, which results in:

- 1) Loss of time,
- 2) Reduced comfort and productivity of transportation,
- 3) Creating congestion and delays.

To avoid such consequences, the drawing up of the system where the traffic flow is not interrupted, but are billed automated application of the latest achievements of information and telecommunication technologies.

### 2.4 Detection of accidents and congestion level monitoring

Detection of accidents is very important in tunnels and other high-risk locations. The system of detection of accidents depends on the size of the accident and the level of traffic flow. Car accident detection is based on the measurement of speed and measurement retention, as evidenced by the inductive loop. The early algorithms, such as the California algorithm, they tried to detect the shock wave resulting from an accident by following the spatial and temporal discontinuity of flow and its retention (time for which the loop is occupied and density of the loop). Experience has shown that of all the parameters that are measured at the inductive loops, the change of speed best indicates the presence of an accident. So far, automatic video analysis could find vehicles that are not moving or are slow moving. But in general video surveillance is used manually only as a supplement to other forms of detectors accident.

## 2.5 Integration with dynamic travel guide

Each intersection controller can basically follow the travel time directly, or indirectly through the detector data in the vehicle. News of the density of traffic on the network can be exchanged allowing it to be made modifications and recommended routes. Driver assistance systems have radar sensors that take into account the traffic from the side and behind the vehicle and constantly inform drivers about potential dangers: when changing lanes, following incoming vehicles that the driver can not see, and warned him not to open the door if you are approaching cyclists. Based on the analysis, the global market for systems that help the driver to the 2015 cost about 1.9 billion euros, for the Member States of the European Union[5]. Since 2010, passengers have access to constant predictions of the traffic situation on their mobile phones, radio and the Internet.

## 3 Conclusion

Smart infrastructure is a intelligent infrastructure which is fully aware of its functioning and is capable of managing its functioning with a control system. The realization of the need for rational traffic system that is economically efficient and environmentally justified, requires a new way of looking at and solving traffic problems. The implementation of these demands requires a whole new philosophy of formation, functioning and management of all components within the transport system, through the effective application of modern management, computer and communications technology in transport. The development of intelligent infrastructure has to deal with society as a whole, given that the benefits achieved its application of higher social interest. In conclusion, the Intelligent infrastructure framework developed in this papers outperforms prior methods and techniques by introducing a more robust and scalable solution, especially for highly-saturated, diverse, and increasingly larger networks. Therefore, this paper offers a major contribution to the complete management road traffic system. The resulting system is also promising for other control applications beyond ATSC that contributes the most to the Intelligent infrastructure as an adaptive solution. In this context, the Intelligent Infrastructure needs to be developed in an integrated way, in order to provide a significant contribution to the economy, environment, social needs and objectives of social development during the next period.

## References

- [1] Chen, K.: PBI: Intelligent Transportation Systems Awareness, Seminar, Seoul, (2009), pp. 78-82.
- [2] Čekić, Š.: Traffic policy, Internal lecture, Faculty of traffic and communication, Sarajevo, (2014), pp. 44-53.
- [3] Hobkirk, I.: "Best in Class Companies – Integrated Transport Management", Aberdeen Group, Boston, pp. 21-28, 2013.
- [4] Sokolija, K.: Intelligent transportation systems, Internal lecture, Faculty of traffic and communication, Sarajevo, 2014.
- [5] Optimal Transport for Applied Mathematicians, Filippo Santambrogio, pp. 121-146, 2015.
- [6] Box, G.E.P.: Robustness in the strategy of scientific model building, in Robustness in Statistics, R.L. Launer and G.N. Wilkinson, pp. 152-168.
- [7] <http://nexus.umn.edu/Papers/DecisionRules.pdf>
- [8] Handbook of Transportation Engineering, The McGraw-Hill Companies, pp. 47-63, 2004.
- [9] Key Transportation Indicators, RITA Bureau of Transportation Statistics, pp. 113-115, 2013.

- [10] Houben, L. J. M., van der Kooij, J., Naus, R. W. M., Bhairo, P.D.: APT testing of modular pavement structure rollpave and comparison with conventional asphalt motorway structures, Accelerated Pavement Testing, pp. 1–24, 2004.
- [11] Groenendijk, J., Westera, G.: “Proefvak rollpave a35. final report.” Innovatieprogramma geluid voor weg- & spoorverkeer (iPG).



## COMPARISON OF SOME CAPACITY AND CONTROL DELAY MODELS ON ROUNDABOUTS

Ivan Lovrić<sup>1</sup>, Sanjin Albinović<sup>2</sup>, Ammar Šarić<sup>2</sup>, Danijela Maslač<sup>1</sup>

<sup>1</sup> University of Mostar, Faculty of Civil Engineering, Bosnia and Herzegovina

<sup>2</sup> University of Sarajevo, Faculty of Civil Engineering, Bosnia and Herzegovina

### Abstract

In the capacity analysis of roundabouts, correctly determining of the degree of saturation and control delay is of the highest importance, because these parameters are the main indicators of traffic flow quality. This paper briefly describes models of compute control delay on roundabouts that are currently most widely used in practice, such as: HCM, Akcelik, Brilon. In conclusion, will be recommended the guidelines for calibration process of these methods.

*Keywords: roundabout, control delay, calibration*

### 1 Introduction

Correct determination of capacity-to-volume ratio and delays, which are basic indicators for quality of traffic movements at intersections, is crucial for roundabout analysis. In practice, there are many methods for determination of level of service at roundabouts, with high dissipation in results. Differences in results are occur because of different approaches in capacity and delay methodologies. In this paper, we give briefly description of capacity and delay models according to Highway Capacity Manual 2010 (HCM 2010), Akcelik (Sidra Intersection) and Brilon, which are the most used methodologies for this purpose.

### 2 Capacity and delay prediction models

Driver delay consists of a many factors relating to traffic control, roundabout geometry, traffic flow and accidents occurance. Total delay is the difference between travel time in real conditions and travel time when there is no traffic control, geometric restrictions or any accidents. Delay control includes time that driver spent during deceleration, time when car is completely stopped and acceleration time. This kind of delay interpretation is presented on Figure 1.

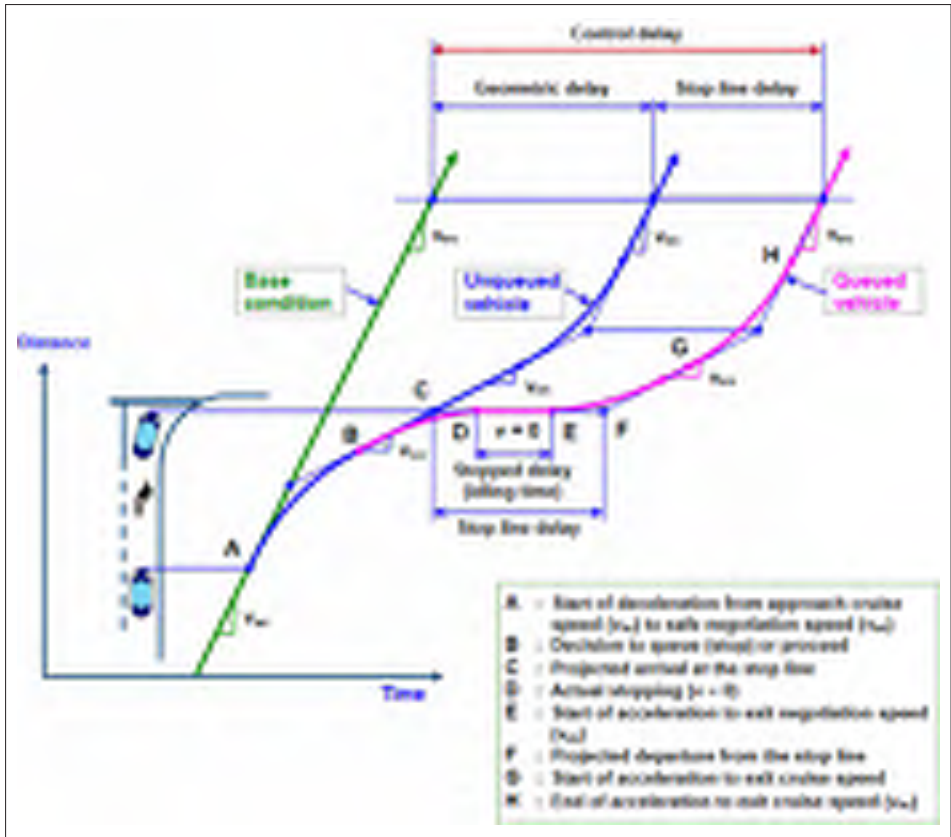


Figure 1 Definition of control delay, geometric delay, stop – line delay and stopped delay (Source: Sidra Intersection – User Guide) [3]

### 2.1 HCM 2010 methodology

Highway Capacity Manual 2010 is based on many years researches of roundabouts in the United States of America. Capacity for single-lane roundabouts, according to this method, can be calculated with following equations:

$$C_{e,pce} = 1130 \cdot e^{(-1.0 \cdot 10^{-3}) V_{c,pce}} \tag{1}$$

Where:

- $C_{e,pce}$  – lane capacity, adjusted for heavy vehicles [pce/h], and
- $V_{c,pce}$  – conflicting flow rate [pce/h].

Analytical model for delay control prediction is:

$$d = \frac{3600}{C} + 900T \left[ x - 1 + \sqrt{(x-1)^2 + \frac{\left(\frac{3600}{C}\right) \cdot x}{450T}} \right] + 5 \min[x, 1] \tag{2}$$

Where:

- $d$  – average control delay [s/veh],
- $x$  – volume-to-capacity ratio of the subject lane [veh/h],
- $c_{m,x}$  – capacity of the subject lane [veh/h],
- $T$  – time period [h] ( $T=0,25$ h for a 15-min analysis).

## 2.2 Akcelik methodology (Sidra Intersection 5.1)

In this paper, we only consider Akcelik M3D model. Equation (3) is used for the capacity calculation based on Rahmi Akcelik researches in Australia:

$$Q_c = \frac{3600}{\beta} \cdot \left( (1 - \Delta_c \cdot q_c) + (0,5 \cdot \beta \cdot \Phi_c \cdot q_c) \right) \cdot e^{-\lambda(\alpha - \Delta_c)} \quad (3)$$

Where:

- $\beta$  – follow up headway [seconds/vehicle],
- $\alpha$  – critical gap [seconds/vehicle],
- $\Delta_c$  – intrabunch headway [seconds/vehicle],
- $q_c$  – circulating flow at entry [pce/hour],
- $\Phi_c$  – proportion of unbunched vehicles in the circulating stream,
- $\lambda$  – parameter in the exponential arrival headway,
- $Q_e$  – capacity of a single entry lane [pce/hour].

Two elements of this equation,  $\Phi_c$  and  $\Delta_c$ , are fixed parameters.  $\Phi_c$  represents the proportion of unbunched vehicles in the circulating stream. Used as a calculated variable in Akcelik's capacity equation, this will be a fixed parameter with the value of 0,55 for this formulation. This is done to maintain simplicity in this paper. In Sidra Intersection User Guide exact equation for  $\Phi_c$  can be found, although it does not have a big influence on final result [2].

Akcelik gives a value of two seconds for  $\Delta_c$  parameters, for circulatory roadway with one lane. The remaining element for this equation is  $\lambda$ . This is a parameter in the exponential arrival headway, that according to Tanner (1962, 1967) can be assumed to be equal to the circulating flow [2]. Method for delay calculation according to Akcelik in Sidra Intersection, is the same like in HCM 2010. The main difference is that this method directly takes geometric characteristics into account, while HCM 2010 considers roundabout geometry through regression part of equation (1). Adjusted delay equation by Akcelik is:

$$D = \frac{3600}{Q_e} + 900 \cdot T_f \left( x - 1 + \left( (x - 1)^2 + \frac{8 \cdot K_d \cdot x}{Q_e \cdot T_f} \right)^{0,5} \right) \quad (4)$$

Where:

- $D$  – average yield line delay [seconds],
- $Q_e$  – capacity of a single entry lane [pce/h],
- $T_f$  – duration of the analysis [hours],
- $x$  – degree of saturation and
- $K_d$  – overflow parameter [ $K_d = 1$ ].

## 2.3 Brilon methodology

The capacity of roundabouts in Germany is studied for many years by numerous researches. For all types of roundabouts, except mini roundabouts, entry capacity is not under influence of vehicle flow at other entries. Following equation is used for capacity calculation by German research Werner Brilon:



$$C = 3600 \cdot \left( 1 - \frac{t_{\min} \cdot q_k}{n_c \cdot 3600} \right)^{n_c} \cdot \frac{n_e}{t_f} \cdot e^{-\frac{q_k}{3600} \cdot \left( t_g \frac{t_f}{2} - t_{\min} \right)} \quad (5)$$

Where:

- C – basic capacity of one entry [veh/h],
- $q_k$  – traffic volume on the circle [veh/h],
- $n_c$  – number of circulating lanes [-],
- $n_e$  – number of entry lanes [-],
- $t_g$  – critical gap [s],
- $t_f$  – follow-up time [s], and
- $t_{\min}$  – minimum gap between succeeding vehicles on the circle [s].

As can be seen from this equation, entry capacity depends on number of circulating lanes and number of entry lanes. Other geometric parameters did not show a significant impact on capacity. The values for parameters  $t_g$ ,  $t_f$  and  $t_{\min}$  depends on type of roundabout and can be calculate using following equations (Table 1).

**Table 1** Parameters for capacity calculation in Brilon metology [4]

Type of roundabout	Number of lanes		Parameters		
	$n_e$	$n_c$	$t_g$	$t_f$	$t_{\min}$
1/1 $26 \leq d \leq 40\text{m}$	1	1	$t_g = 3,86 + \frac{8,27}{d}$	$t_f = 2,84 + \frac{2,07}{d}$	$t_{\min} = 1,57 + \frac{18,6}{d}$

Roundabout diameter used in this example is 29 m. The formula developed by Brilon for average delay estimation at roundabout entry is:

$$D = \frac{3600}{C} + \frac{900}{C} \cdot \left[ \sqrt{(R \cdot T - 2)^2 + 8 \cdot C \cdot T} - (R + T + 2) \right] \quad (6)$$

Where:

- d – average delay (queueing delay) [veh/s],
- C – capacity [veh/h],
- T – duration of the peak period [h],
- R – reserved capacity [veh/h],
- q – total volume [demand] [veh/h].

### 3 Basic differences in described models

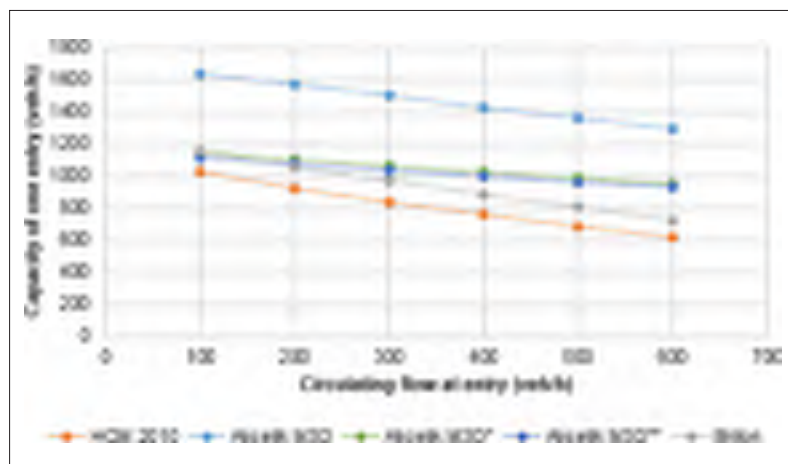
Methodologies presented here have been applied to single-lane roundabout with different values for circulating flow at entry (from 100 to 600 veh/h), while critical gap and follow up headway are taken in accordance with recommendations for each methodology (Table 2). We take three different cases for Akcelik calculation:

- 1) Akcelik – default values for critical gap and follow up headway which can be found in Sidra Intersection software,
- 2) Akcelik\* – Akcelik methodology with recommended values for critical gap and follow up headway by HCM 2010,
- 3) Akcelik\*\* – critical gap and follow up headway values recommended by [2].

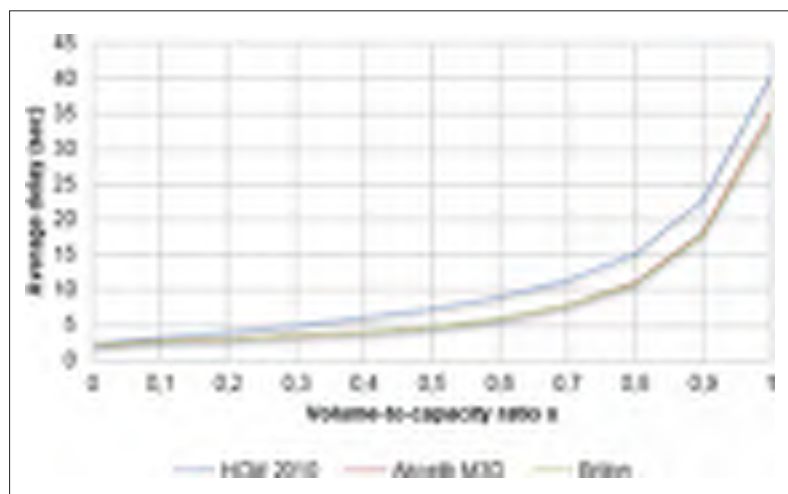
For Brilon methodology, critical gap and follow up headway are calculated using equations from Table 1 and given roundabout diameter. Comparing different equations for delay, it is clear that differences between them are negligible. Equations for capacity are also based on similar approach, and in all of them critical gap, follow up headway and circulating flow are key parameters. The results are presented in the following Figures 2 and 3.

**Table 2** Different values for critical gap and follow up headway

	Akcelik M3D	Akcelik M3D*	Akcelik M3D**	Brilon
Critical gap (sec)	4	4,3	3,5	4,145
Follow up headway (sec)	2	2,85	3	2,911



**Figure 2** Comparison of roundabout capacity for different metodologies



**Figure 3** Comparison of average delay for different metodologies

## 4 Conclusion

The main conclusions according to obtained results and presented figures are:

- Differences between delay models are negligible (HCM 2010 provides some higher results because of additional part of delay).
- Akcelik's diagram for delay (Figure 1) completely explained methodology for delay calculation and it can be used like a methodology for practical determination of delay in real conditions, on the field.
- Figure 2 shows that the highest values for capacity gives Akcelik and they much depends on critical gap and follow up headway. Hence, it is easiest to make a mistake using this methodology, specially using Sidra Intersection software where capacity is very sensitive to "environment factor".
- HCM 2010 method uses fixed values for gap acceptance parameters, while Sidra standard model gap acceptance parameters depend on the geometry and flow rate.
- The capacity has much bigger impact on level of service analyses, because delay models are equal. The most important parameters for capacity determining in all methodologies are critical gap and follow up headway. Recommended values for these parameters are different for all methodologies, so their determination is crucial for quality and correct analysis.

Further researches must be focused on correct calibration process all of these methodologies. Only then, results will match real conditions.

## References

- [1] Highway Capacity Manual: Practical Applications of Research. U.S. Dept. of Commerce, Bureau of Public Roads, 2010
- [2] Seiberlich, L. E.: A formulation to evaluate capacity and delay of multilane roundabouts in the United States for implementation into a travel forecasting model, Master Thesis, The University of Wisconsin-Milwaukee, december 2001.
- [3] Sidra Intersection User Guide, Akcelik and Associates Pty Ltd., november 2012.
- [4] Brilon, W.: Studies on Roundabouts in Germany, The 3<sup>rd</sup> International TRB – roundabout Conference, Carmel, Indiana, (2011.), p. 11
- [5] Akcelik, R.: Some common and differing aspect of alternative models for roundabout capacity and performance estimation, International Roundabout Conference, Transportation Research Board, Carmel, Indiana, USA, 18-20 May 2011.

## 2 ROAD PAVEMENT





## STUDY OF COMPACTABILITY MODELS DESCRIBING ASPHALT SPECIMEN COMPACTION WITH GYRATORY AND WITH IMPACT COMPACTOR

Marjan Tušar<sup>1,3</sup>, Miha Šlibar<sup>2</sup>, Aleksander Ipavec<sup>3</sup>, Mojca Ravnikar Turk<sup>3</sup>

<sup>1</sup> National Institute of Chemistry, Slovenia

<sup>2</sup> Domplan d.d., Kranj, Slovenia

<sup>3</sup> Slovenian national building and civil engineering institute (ZAG), Ljubljana, Slovenia

### Abstract

The service life of pavement surface courses is highly dependent on the construction process. A large number of parameters have to be controlled and kept at optimum during the laying and compaction process. The compactability of asphalt mix is the most important feature at the time of paving. Proper compaction of asphalt layer ensures that the pavement can achieve the planned service life, the bearing capacity and the resistance to low and high temperatures. In this study, the compactability determined by the gyratory and impact compactor was investigated. The standardized model as described in the European standard EN 12697-10 for the compaction propagation was evaluated with the data obtained from the tests performed on five different asphalt mixtures. Past research showed that the ‘standardized model’ that is currently used for the impact compactor does not describe the compaction process appropriately. In a published article three new solutions were proposed. With present study we tried to find out if the new proposed models can be used to properly describe compactability of asphalt specimen determined with gyratory compactor.

*Keywords: compactability, gyratory compactor, impact compactor, model*

### 1 Introduction

Produced asphalt is non compacted mixture of stone aggregate in a binder matrix. Asphalt mix must be compacted according to certain standards to construct a sustainable pavement. Compaction means reduction in the volume of the mixture of hot asphalt binder, aggregates, and filler materials to form the required dense mass. Construction of asphalt pavements takes advantage of the direct and indirect compacting forces, exerted by rollers passing over the loose mix to produce dense layers of structurally durable material [1]. It was published that more than 80 % of premature failures of asphalt pavements are related to insufficient compaction [2, 3]. With decreasing of voids in the matrix, the material becomes less susceptible to moisture penetration [4, 5].

Compactability of the asphalt pavement can be defined as the ease with which the material can be compacted [4]. The most important factors that influence on the process of compaction are: materials used in the asphalt mixture, environmental variables (temperature, wind, and humidity), method for compaction, compaction temperature [6, 7].

Many studies were performed to evaluate correlation between compaction and asphalt properties [8-12].

In this study we followed the procedures described in European standard EN 12697 – 10 [13] where three laboratory test methods for obtaining compactability are described: impact com-

paction, gyrator compaction and vibratory compaction. From previous studies it was found out that the model for impact compaction in the standard can be improved [14, 15]. It was proposed that ‘standardized model’ presented with eqn (1) should be replaced with ‘supplemented model’ presented with eqn (2):

$$\frac{1}{t(E)} = \frac{1}{t_{\infty}} - \left[ \frac{1}{t_{\infty}} - \frac{1}{t_0} \right] * e^{\frac{-E}{T}} \quad (1)$$

$$\frac{1}{h(E)} = \frac{1}{h_{\infty}} - \left[ \frac{1}{h_{\infty}} - \frac{1}{h_0} \right] * e^{\frac{-E}{T_1}} + F * e^{\frac{-E}{T_2}} \quad (2)$$

Where:

- t(E) – thickness of the specimen compacted at compaction energy E;
- t<sub>∞</sub> – is the calculated minimum achievable thickness of the specimen;
- t<sub>0</sub> – is the calculated initial thickness of the specimen;
- E – is the compaction energy;
- T – is the compaction resistance.

It was proposed that in the case when we are not able to use the appropriate software to calculate more demanding mathematical models, exclusion of first 30 data, is a proper choice [15].

## 2 Experimental details

Encouraged with the results of our previous studies [14, 15], we tried to find out if standardized model describing gyrator compaction can also be improved. We investigated if the proposed mathematical model for impact compaction was acceptable for the obtained experimental data. At gyrator compaction bituminous mixture is contained within a cylindrical mould limited by inserts and kept at a constant temperature within specified tolerances throughout the whole duration of the test [16].

Compaction is achieved by the simultaneous action of a low static compression, and of the shearing action resulting from the motion of the axis of the sample which generates a conical surface of revolution, of apex O and of 2 φ angle at the apex, while the ends of the test piece should ideally remain perpendicular to the axis of the conical surface as shown in Figure 1 [16].

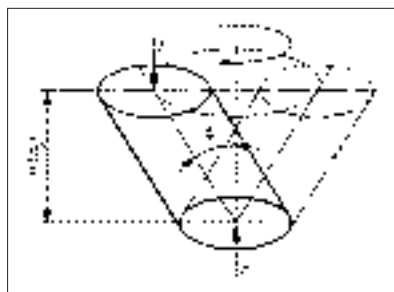


Figure 1 Sample motion diagram at gyrator compaction

### 2.1 Materials

Five different asphalt mixtures were collected from asphalt producers. Three different asphalt concrete samples (AC 8 surf, AC 16 surf and AC 32 base containing B 50/70 bitumen) and two different stone mastic samples (SMA 8 surf and SMA 8 surf containing PmB as binder and steel slag as stone aggregate) were tested.

## 2.2 Experimental design and conditions

Each sample was compacted in two moulds with diameters 150.0 mm and 100.0 mm. For each mould two different quantities of material were prepared: one for expected final height of specimen 100 mm and second for expected final height of specimen 150 mm. So for each type of asphalt 4 different dimensions of specimen were prepared. The following compaction conditions were set: target gyrations (100), speed: 30 rev/min, angle: 0,820 degrees and stress: 600 kPa. For comparison Marshall specimen with impact compactor were prepared. The compaction temperatures were for all samples set according to EN 12697-35.

## 2.3 Experimental results

Samples were compacted in random order. After cooling we measured final height and density for each specimen. Final densities of samples are presented in Table 1.

**Table 1** Densities of samples after 100 gyrations, where h is expected height of specimen and fi is diameter of the mould.

Dimension of sample [mm]	SMA 11 [Mg/m <sup>3</sup> ]	SMA 8 [Mg/m <sup>3</sup> ]	AC 16 [Mg/m <sup>3</sup> ]	AC 8 [Mg/m <sup>3</sup> ]	AC 32 [Mg/m <sup>3</sup> ]
fi100, h=150	<b>2.916</b>	2.801	2.460	2.472	2.474
fi150, h=150	2.891	2.825	2.527	2.450	2.518
fi100, h=100	2.878	2.838	2.547	2.532	2.546
fi150, h=100	2.893	<b>2.840</b>	<b>2.551</b>	<b>2.534</b>	<b>2.563</b>
Marshall specimen	2.836	2.839	2.503	2.497	2.502

From Table 1 it can be seen that for almost all types of asphalt the densest was sample with diameter 150 mm and final thickness 100 mm. Only exception was SMA 11 where the densest was sample with diameter 100 mm and final thickness 150 mm, but varieties between densities of samples for both SMA mixtures are small.

## 3 Results

### 3.1 Compactability according to the standard

First compactability according to the standard EN 12697-10 was calculated. The 'standardized model' is presented with eqn 3.

$$v(\text{ng}) = v(1) - (K \cdot \ln \text{ng}) \quad (3)$$

Where:

- $v(\text{ng})$  – void content for a number of gyration ng, expressed in percent (%);
- $v(1)$  – is the calculated void content for one gyration;
- K – is the compactability (method using a gyratory compactor);
- ng – is the number of gyrations.

From Table 2 it can be seen that calculated compactabilities K have very stochastic values. It can be seen that the standard deviation over different types of asphalt mixtures compacted in the same mould is on average smaller than standard deviation for a particular asphalt mixture compacted in the moulds of different dimensions. From results in Table 2 it can be concluded that compactabilities K calculated according to the standard EN 12697-10 cannot be used to distinguish between different types of asphalt.



**Table 2** Compactability K according to the standard EN 12697-10.

Dimension of sample [mm]	SMA 11 K	SMA 8 K	AC 16 K	AC 8 K	AC 32 K	Standard deviation over different types of asphalt mixture
fi100, h=150	4.00	3.83	3.12	3.73	3.22	<b>0.39</b>
fi150, h=150	3.66	3.58	3.39	3.82	3.32	<b>0.20</b>
fi100, h=100	4.14	4.35	4.22	4.02	4.25	<b>0.12</b>
fi150, h=100	3.86	3.59	3.74	3.40	3.85	<b>0.19</b>
Standard deviation over different mould dimensions	<b>0.21</b>	<b>0.36</b>	<b>0.47</b>	<b>0.26</b>	<b>0.48</b>	

### 3.2 Alternative model

Due to the fact that height of the specimen is automatically obtained from apparatus during compaction process the first ‘simple’ model containing height of specimen as factor was tested. According to standard the height of specimen after 5, 10, 15, 20, 25, 30, 35, 40, 45, 50, 55, 60, 65, 70, 75, 80, 85, 90, 95, and 100 gyrations shall be obtained from apparatus. With altogether 20 experimental points variety of models can be built. First simple alternative model was tested (eqn 4).

$$\ln t = A - (B \cdot \ln ng) \quad (4)$$

Where:

- t – height of the specimen for a number of gyration ng, expressed in mm;
- A – factor related to height of the specimen for one gyration;
- B – alternative compactability;
- ng – number of gyrations.

For comparison between the ‘standardized model’ and the ‘alternative model’ correlation coefficients were gathered in Tables 3 and 4. From Tables 3 and 4 it can be seen that both models are good and correlation coefficients are almost equal. Small difference can be found only for both SMA mixtures, where ‘alternative model’ works a bit better. Both models gave the lowest correlation coefficients for AC, however for this mixture standard model works a bit better.

**Table 3** Correlation coefficients between directly measured heights of specimen and heights of specimen calculated according to ‘standardized model’ (eqn 3).

Dimension of sample [mm]	SMA 11 r <sup>2</sup>	SMA 8 r <sup>2</sup>	AC 16 r <sup>2</sup>	AC 8 r <sup>2</sup>	AC 32 r <sup>2</sup>	Average for different types of asphalt
fi100, h=150	0.9989	0.9983	0.9995	0.9988	0.9992	0.9990
fi150, h=150	0.9981	0.9983	0.9985	0.9998	0.9991	0.9987
fi100, h=100	0.9992	0.9993	0.9996	0.9942	0.9992	0.9983
fi150, h=100	0.9964	0.9986	0.9995	0.9950	0.9995	0.9978
Average for different mould dimensions	0.9981	0.9986	0.9993	0.9969	0.9993	

**Table 4** Correlation coefficients between directly measured heights of specimen and heights of specimen calculated according to ‘alternative model’ (eqn 4).

Dimension of sample [mm]	SMA 11 $r^2$	SMA 8 $r^2$	AC 16 $r^2$	AC 8 $r^2$	AC 32 $r^2$	Average for different types of asphalt
fi100, h=150	0.9997	0.9994	0.9996	0.9978	0.9987	0.9990
fi150, h=150	0.9990	0.9993	0.9992	0.9996	0.9998	0.9994
fi100, h=100	0.9998	0.9992	0.9990	0.9915	0.9993	0.9978
fi150, h=100	0.9979	0.9992	0.9989	0.9936	0.9993	0.9978
Average for different dimensions	0.9991	0.9993	0.9992	0.9956	0.9993	

### 3.3 Model proposed for impact compactor

It was found out that the ‘standardized model’ for impact compactor (eqn 1) is not appropriate even for impact compactor [14, 15], when all data is used. Consequently in this study a standardized model proposed for impact compactor was used (eqn 1), but according to experience from previous studies [14, 15], the data of the first 30 records on the specimen height were excluded from the calculation. Correlation coefficients between directly measured heights and heights of specimen calculated according to the model (eqn 1) are gathered in Table 5.

**Table 5** Correlation coefficients between directly measured heights of specimen and calculated heights of specimen according to model for impact compactor (eqn 1) with exclusion of the first 30 records.

Dimension of sample [mm]	SMA 11 $r^2$	SMA 8 $r^2$	AC 16 $r^2$	AC 8 $r^2$	AC 32 $r^2$	Average for different types of asphalt
fi100, h=150	0.9995	1.0000	0.9994	0.9994	0.9994	0.9995
fi150, h=150	0.9998	0.9994	0.9991	0.9997	0.9996	0.9995
fi100, h=100	0.9993	0.9990	0.9995	0.9985	0.9992	0.9991
fi150, h=100	0.9995	0.9988	0.9996	0.9971	0.9993	0.9988
Average for different dimensions	0.9995	0.9993	0.9994	0.9987	0.9994	

From Table 5 it can be seen that model proposed for impact compactor works well also for gyratory compactor. Correlation coefficients are even higher than for ‘standardized model’ (Table 3). In Table 6 compactabilities T calculated according to the model for impact compactor (eqn 1) with exclusion of the first 30 records [15] are presented. From Table 6 it can be seen that calculated compactabilities T have less stochastic values than compactabilities K in Table 2.

**Table 6** Compactability T calculated according to the model for impact compactor (eqn 1) with exclusion of the first 30 records.

Dimension of sample [mm]	SMA 11 T	SMA 8 T	AC 16 T	AC 8 T	AC 32 T	Standard deviation over different types of asphalt mixture
fi100, h=150	56.05	60.06	59.42	44.05	42.86	8.39
fi150, h=150	54.59	59.25	55.66	53.62	66.50	5.25
fi100, h=100	65.22	48.96	47.63	36.51	54.83	10.51
fi150, h=100	48.40	51.34	50.56	31.04	54.54	9.29
Standard deviation between different dimensions	6.95	5.58	5.25	9.79	9.65	

## 4 Conclusions

In the European standard EN 12697 – 10 are described methods to determine the compactability of the asphalt mixtures. In previous studies the compaction by impact compaction was evaluated [15] and some improvements were proposed. With this study compaction by gyratory compactor was evaluated.

Five different asphalt concrete mixtures were tested. From obtained result for different types of asphalt we found out that Compactabilities  $K$  calculated according to the standard EN 12697-10 cannot be used to distinguish between different types of asphalt. One solution for this problem is to exactly prescribe dimension of sample in the standard EN 12697-10. We propose that diameter of mould should be specified and final height of specimen should be in clearly defined range similarly as it is prescribed for impact compactor. The other solution is to use alternative model. It was found out that even simple model (eqn 4) could be more suitable for some asphalt mixtures than standardized model. The most logical results were obtained with model proposed for impact compactor [15].

## References

- [1] Masad, E., Koneru, S., Scarpas, T., Kassem, E., Rajagopal, K.: Modeling of Hot-Mix Asphalt Compaction: A Thermodynamics-Based Compressible Viscoelastic Model, Texas, December 2010.
- [2] Mo, L., Li, X., Fang, X., Huurman, M., Wu, S.: Laboratory investigation of compaction characteristics and performance of warm mix asphalt containing chemical additives, *Construction and Building Materials*, vol. 37, pp. 239-247, 2012.
- [3] Liu, H., Yin, R., Wu, S.: Reducing the Compaction Segregation of Hot Mix Asphalt, *Journal of Wuhan University of Technology-Mater. Sci. Ed.*, vol. 22, no. 1, pp. 132-135, 2007.
- [4] Ter Huerne, H.: *Compaction of Asphalt Road Pavements*, Enschede: H.L. ter Huerne, CT&M Department, 2004.
- [5] Mohamed, E.H.H., Abd El Halim, A.O., Kennepohl, G.J.: Assessment of the influence of compaction method on asphalt concrete resistance to moisture damage, *Construction and Building Materials*, vol. 7, no. 3, pp. 149-156, 1993.
- [6] Kassem, E.A.-R.: *Compaction effects on uniformity, moisture diffusion, and mechanical properties of asphalt pavements*, The Texas A&M University, 2008.
- [7] Bahia, H.U., Fahim, A., Nam, K.: Prediction of Compaction Temperatures Using Binder Rheology, in *Transportation Research Circulare E-C105*, Washington, DC, Transportation Research Board, 2006.
- [8] Khan, Z.A., Al-Abdul Wahab, H.I., Asi, I., Ramadhan, R.: Comparative study of asphalt concrete laboratory compaction methods to simulate field compaction, *Construction and Building Materials*, vol. 12, pp. 373-384, 1998.
- [9] Sanchez-Alonso, E., Vega-Zamanillo, A., Castro-Fresno, D.: Effect of Type of Compaction on Mechanical Properties in Warm-Mix Asphalts, *Journal of Materials in Civil Engineering*, pp. 1043-1049, 2012.
- [10] Kassem, E., Scullion, T., Masad, E., Chowdhury, A., Liu, W., Estakhri, C., Dessouky, S.: Comprehensive evaluation of compaction of asphalt pavement and development of compaction monitoring system, The Texas A&M University System, 2012.
- [11] Jönsson, M., Partl, M.N., Flisch, A.: *Comparisson of Different Compaction Methods Using X-ray Computer Tomography*, EMPA, 2002.
- [12] Masad, E., Kassem, E., Chowdhury, A., You, Z.: *A method for predicting asphalt mixture compactability and its influence on mechanical properties*, Texas Department of Transportation, Austin, Texas, 2009.
- [13] EN 12697 – 10: Bituminous mixtures – Test methods for hot mix asphalt – Part 10: Compactibility, 2002.

- [14] Ramljak, Z., Ramljak I., Šafran, T.: New approach to validation of results of asphalt compactibility measurements according to EN 12697 – 10 method, in Proceedings of 12 th Colloquium on Asphalt and Bitumen, Kranjska gora, 2009.
- [15] Tušar, M., Ramljak, I., Avsenik, L.: Validation of results of asphalt compactability determined by impact compactor according to EN 12697-10 and suggested new solutions for better predictions. Construction and Building Materials, vol. 91, pp. 243-250, 2015.
- [16] EN 12697 – 31: Bituminous mixtures – Test methods for hot mix asphalt – Part 31: Specimen preparation by gyratory compactor, 2012.





## THE BEST PRACTISE OF THE OF RECYCLED TYRE RUBBER MODIFIED ASPHALT BINDERS AND MIXES

Ovidijus Šernas<sup>1</sup>, Donatas Čygas<sup>2</sup>, Audrius Vaitkus<sup>1</sup>

<sup>1</sup> Vilnius Gediminas Technical University, Road Research Institute, Lithuania

<sup>2</sup> Vilnius Gediminas Technical University, Road Department, Lithuania

### Abstract

Rubber derived from grinding of recycled cars and trucks tyres may be successfully used as a binder modifier or supplementary component of the asphalt mix. Number of researches reported sufficient characteristics of rubber modified asphalt binders or modified asphalt mixes in terms of improved permanent deformation and fatigue cracking. The behavior of asphalt binders or asphalt mixes modified with recycled crumb rubber depends on several factors, such as modification method, rubber content and size, modification temperature, mixing speed and time applied during the digestion process. This paper summarizes findings from literature review on the existing technologies and specifications related to the asphalt binders and asphalt mixes modification process with crumb rubber. Moreover, this article summarizes the effect of modified asphalt binder behavior in high and low temperatures. After analysis of the best practise, the algorithm of rubber modified binder and asphalt mix design model was introduced.

*Keywords: tyre recycled rubber, modified binder, rubber modified asphalt mix, permanent deformation, fatigue*

### 1 Introduction

The increasing number of vehicles on the roads generates millions of used tyres every year. Used tyres due to the amount and durability are the most problematic sources of waste. Those, same characteristics make waste tyres one of the most re-used waste materials, as rubber is very resilient and can be reused in other products. One of the most successful application is the use waste tyres in road pavements [1]. Asphalt is known as brittle and hard in cold environments and soft in hot environments. As a pavement material, it is characterized with a number of failures represented by the low temperature cracking, fatigue cracking, and the permanent deformations at high temperature [2]. Scientists suggest failures preventing solutions as the use of high modulus asphalt mixes with polymer modified binder, pavement structure design models with main objectives: field of application, input data (environmental/climate conditions, structural conditions, design materials and loading conditions) and analysis procedure (pavement response to load, pavement response to frost heave and performance (design) criteria). Moreover, there is suggested to apply continuously monitoring of different pavement structures performance and to elaborate on the most suitable and economically effective pavement structures [3-5]. Modification of asphalt binder is a very common practice these days in order to improve its physical properties and performance. Modification of asphalt decreases its temperature susceptibility and this enables asphalt to withstand more load and more severe environments [6]. Incorporation of used tires in asphalt mixtures has been a major advancement in the using recycled materials in asphalt

pavements. Tires contain some of the polymeric components that have been used to modify the asphalt binders for decades, but in a solid form [7]. The use of crumb rubber in asphalt pavements has shown promising beneficial results in previous studies. The aim of this study is to evaluate previous researches and existing specifications on crumb rubber modified binder and asphalt mixtures and provide recommendations based on the best experience.

## 2 Review of existing modifying technologies and specifications

After the collection of end of life tyres, the next stage of the tyre recycling process is shredding and milling of scrap tyres. Ambient grinding and cryogenic grinding are the most common processes [8]. The use of tyre rubber in bituminous paving materials generally has two distinct approaches: wet process and dry process. Moreover, according to Caltrans [9], the wet process is divided into two families: wet process-high viscosity (asphalt rubber) and high process-no agitation (terminal blend). Detailed description of all this technologies and specifications are given in the following paragraphs.

### 2.1 Analysis of the dry method

The idea of adding the rubber particles is to substitute a small portion of aggregates with rubber, for the rubber to function just like the aggregates but with additional benefit of possessing elastic properties as illustrated in Figure 1 [10]. The crumb rubber, as a mixture component, at the ambient temperature is added into a blend of heated aggregates prior to introducing binder into the process.

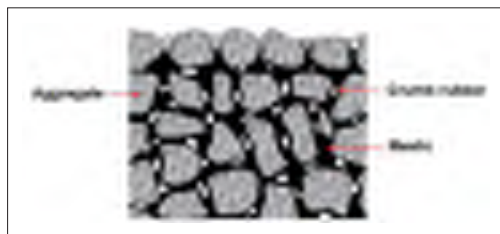


Figure 1 Rubber particles distribution within a gap-graded mixture [10]

Previous studies have specified that in the dry process coarser rubber is used and with this modification, the coarse rubber particles (0.4–10 mm) act as elastic aggregates to increase the mixture's flexibility under loading. Reaction between binder and crumb rubber is considered negligible because the mixtures are fabricated without any significant interaction time between binder and crumb rubber [9, 11, 12]. Higher binder content (1%-2% higher) is needed for the rubberised mixture compared to the conventional mixture for the same aggregate type and gradation [13]. Because of demonstrated variable results, there was a certain lack of confidence in the dry process. However, the most recent researches have recommended to use 0.5-1.5 % of smaller rubber particles (e.g.  $\leq 0.6$  mm) [14-15]. The dry process can be used in all types of asphalt mixtures. Currently, there is no official guidelines or regulations for dry method modification.

### 2.2 Analysis of specifications for the wet process-high viscosity method

According to Caltrans [9], the rubber modified binder that maintain or exceed the minimum rotational viscosity threshold of 1.5 Pa·s at 177 °C (or 190 °C) over the interaction period should be described as asphalt rubber binder. These materials require continue agitation,

with special equipment, to keep the rubber particles uniformly distributed. Current Caltrans specifications for asphalt rubber binder call for  $20 \pm 2$  % crumb rubber content by total binder mass [16]. The crumb rubber must include  $25 \pm 2$  % by mass of high natural rubber and  $75 \pm 2$  % scrap tire crumb rubber. The crumb rubber consists primarily of 2 mm to 0.6 mm sized particles. An asphalt modifier, of resinous, high flash point aromatic hydrocarbon compounds (extender oils), is added at a rate of 2.5 to 6.0 % by mass of the asphalt binder. Requirements for the asphalt rubber (after 45 min interacting) are given in the Table 1.

**Table 1** Requirements for the asphalt rubber after 45 minutes interacting [16]

Quality characteristic	Test method	Requirement
Cone penetration at 25 °C (mm <sup>-1</sup> )	ASTM D217	25–70
Resilience at 25 °C (min, %)	ASTM D5329	18
Softening point (°C)	ASTM D36/36M	52–74
Viscosity at 190 °C (Pa·s) <sup>a</sup>	ASTM D7741/D7741M	1.5–4.0

<sup>a</sup>Prepare sample for viscosity test under California Test 388.

During interacting period, the asphalt rubber binder mixture must be stored at 190-218 °C temperature [16]. The asphalt rubber is typically used in gap or open-graded mixes. Asphalt rubber is not best suited for use in dense-graded HMA because there is no enough void space in the dense-graded aggregate matrix to accommodate sufficient asphalt rubber binder content to enhance performance of dense-graded mixes enough to justify the added cost of the binder.

### 2.3 Analysis of the specifications for the wet process-no-agitation

This is the most recent modifying technology, where crumb rubber is blended with hot binder at the refinery or at a binder storage and distribution terminal and transported to the asphalt plant/job site for use. This technology allows the crumb rubber using as an alternative modifier to polymers, because in this process modifying conditions are similar to polymer modified binder. The crumb rubber is fully digested into the asphalt and polymer without leaving visible, discrete rubber particles [1] (Fig. 2). The terminal blend generally contains 5 % to over 20% crumb rubber, depending on the manufacturer [11]. Polymers and other additives may also be included. In the past, rubber contents for such blends have generally been  $\leq 10$  % by weight of binder, but some products now include 15% or more crumb rubber [1]. According to Ambaiowei et al. (2014), terminal blends involves 5-12 % crumb rubber particles ( $\leq 0.6$  mm) [17]. The most recent specifications for terminal blends are given in the Caltrans 2015, where modified asphalt binder is defined as asphalt binder modified with polymers, crumb rubber, or both. Requirements for this binder are the same as for polymer modified binders [16]. Considering this facts, viscosity at 135 °C must  $\leq 3.0$  Pa·s whereas asphalt rubber's viscosity at 190 °C must be 1,5-4,0 Pa·s. Moreover, solubility of the rubber particles must be  $\geq 97.5$  %. A minimum of 10 % of crumb rubber by mass of binder is required.



**Figure 2** Asphalt rubber (on the left) and terminal blend (on the right) [1]

In the European countries, there is poor literature in this field – only Germany, Poland and Czech Republic have requirements for terminal blends. In Polish standard PN-EN 14023:2011/ Ap1 (2014) is noticed, that binder, modified with crumb rubber, should be marked with sym-



bol CR (e.g. PMB 25/55-60 CR) [18]. That means, that requirements for terminal blends are the same as for polymer modified binder. In German recommendations “Recommendations for rubber-modified binder and asphalts (E GmBA 12), there is given modifying temperature is  $\geq 180$  °C and the recommended amount of the crumb rubber is 10-20 % ( $\leq 1.0$  mm) crumb rubber [19]. There is no requirements for modified binder viscosity. Asphalt mixtures (SMA, AC, PA) with modified binder (e.g. GmB 25/55-65 and GmBT 25/55-65, respectively wet process and dry process) can be used even for all the highest traffic road pavements. In Czech Republic technical specifications “Technical Recommendation of the Ministry of Transport No 148 Asphalt Rubber pavement courses” for modified binder is given main requirements: crumb rubber amount 5-15 %, viscosity at 150 °C 0.5-1.0 Pa·s and minimum softening point 55 °C, penetration 25-75 mm<sup>-1</sup> [20]. Generally, the terminal blends must meet the standard EN 14023 requirements. Terminal blends can be used in all paving and maintenance applications.

### **3 The effect of asphalt binder and asphalt mixtures modifying on high and low temperatures behaviour**

#### **3.1 Dry process**

The majority of mechanical testing was undertaken to evaluate mixtures performance in terms of stiffness modulus, permanent deformation and fatigue resistance [13]. Researchers in previous studies have identified the most important variables, which influences performance of the crumb rubber modified asphalt mixtures: rubber gradation and content, aggregate gradation, mixing temperature and curing time prior to compaction (for rubber- binder interactions). The main importance of adding crumb rubber to binder is that the rubber imparts stiffness and elasticity to the binders, which helps increase pavement fatigue life or fatigue resistance, as well as reduces reflective cracking and susceptibility to low-temperature cracking [21]. Kim et al. (2014) have found that fatigue resistances of crumb rubber modified mixtures were significantly improved, compared with the reference mixture without crumb rubber, but the moisture resistance after freeze/thaw treatment was found to be very poor [22]. Dias et al. noticed that crumb rubber modified mixes are less sensitive to high temperatures (above 30 °C) and are more resistant to fatigue than the reference mix [12]. Moreover, crumb rubber modified mixes have shown better resistance to permanent deformations [12, 14]. Chen et al. (2015) pointed out that the use of crumb rubber as mineral filler in an asphalt mixture is helpful in improving the thermal stability of the asphalt mixture, but it slightly reduced the moisture resistance [23].

#### **3.2 Wet process**

Considering the facts that wet process-high viscosity process requires additional equipment and it is very complicated technology, this paragraph is focused only on the wet process-no agitation process. A lot of scientists evaluated crumb rubber influence on modified binder behaviour at low and high temperatures and obtained promising results. Ghavibazoo et al. have suggested optimal conditions of modification process: 190 °C temperature, modifying process duration 240 min and speed 50 Hz, 10 % crumb rubber [6]. Another Ghavibazoo et al. (2014) research has indicated that the addition of crumb rubber to asphalt can enhance (decrease) the stiffness of the asphalt at very low temperatures and this enhancement intensifies by increasing the crumb rubber dissolution in binder [24]. Kok and Colak (2011) indicated that to achieve the same performance, as with SBS-modification, the CR-content must be used at much higher than SBS [25]. 8% crumb rubber modification was determined as the most suitable content by determining the permanent and fatigue characteristics and stiffness modulus tests of the control and modified asphalt mixtures. Sybilski et al. (2014) indicated that high modulus asphalt mixtures with crumb rubber modified binder PMB 25/55-60 CR after long

term ageing have shown better resistance to fatigue than mixtures with binder PMB 25/55-60 [26]. Opposite to this, non-aged asphalt mixtures with binder PMB 25/55-60 CR have shown worse resistance to fatigue. Moreover, asphalt mixtures with binder PMB 25/55-60 CR have shown better resistance to low temperatures. The addition of crumb rubber into binder can improve temperature susceptibility, rutting and fatigue characteristics, durability pavements and resistance to oxidative ageing [27]. Poland company “Lotos” noticed that their crumb rubber modified binder PMB 25/55-60 CR and PMB 45/80-55 CR meets with requirements of binder PG 82-22 [28].

#### 4 Rubber modified binder and asphalt mixture design algorithm

From the analysis of existing specifications and scientific researches results, there is drawn a flowchart of rubber modified binder and asphalt mixture design algorithm (Fig. 3).

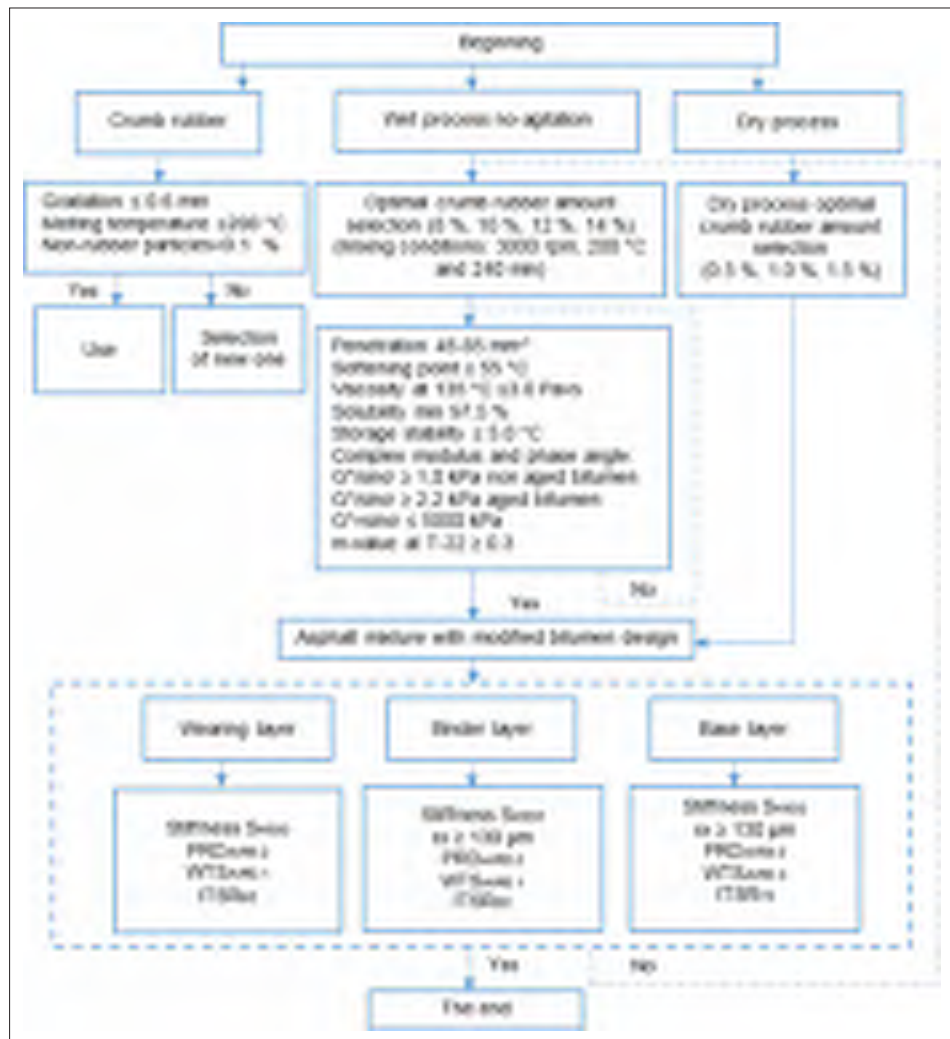


Figure 3 Algorithm of modifying binder and asphalt mixes with crumb rubber

## 5 Conclusions

The best practise of crumb rubber usage for binder and asphalt mixtures modification has provided better understanding of modifying technologies. Both asphalt modification methods (wet and dry processes) are reasonable for rutting resistance, fatigue and low temperature cracking improvement. The main variables in the dry process are rubber gradation and content, aggregate gradation, mixing temperature and curing time prior to compaction: it is recommended to use 0.5-1.5 % crumb rubber ( $\leq 0.6$  mm) by total mass of mixture for gap and dense graded asphalt mixtures, mixing temperature should be higher 10-20°C than traditional asphalt mixtures. Additionally, it is recommended to apply 60-120 min curing period after mixing.

As wet process-high viscosity is quite sophisticated technology with need of additional installation and asphalt rubber is suitable just for open and gap-graded asphalt mixtures, the widespread use is questionable. As wet process-no agitation technology is very similar to polymer modification technology and asphalt performance results shows very good results it is the most recommended technology for asphalt modification with crumb rubber. Terminal blends can be used in all paving applications and even for the highest traffic road pavements. It is recommended to use that modifying conditions: crumb rubber content 8-14 % by mass of binder, modifying temperature 200 °C and speed 50 Hz.

There is strongly recommended to perform modified binder solubility, viscosity and storage stability tests. Moreover, modified binder and asphalt mixes must be tested before and after long-term ageing procedure. Crumb rubber modified binders must comply with requirements for polymer modified binders and can be classified in the performance graded (PG) system.

## References

- [1] Presti, D.: Recycled Tyre Rubber Modified Bitumens for Road Asphalt Mixtures: A Literature Review, *Construction and Building Materials* 49 (2013), pp. 863–881, doi: 10.1016/j.conbuildmat.2013.09.007
- [2] Cong, P., Xun, P., Xing, M., Chen, S.: Investigation of Asphalt Binder Containing Various Crumb Rubbers and Asphalts, *Construction and Building Materials*, 40 (2013), pp. 632–641, doi: 10.1016/j.conbuildmat.2012.11.063
- [3] Cygas, D., Laurinavicius, A., Paliukaite, M., Motiejunas, A., Ziliute, L., Vaitkus, A.: Monitoring the Mechanical and Structural Behavior of the Pavement Structure Using Electronic Sensors, *Computer-aided Civil and Infrastructure Engineering* 30 (2015), pp. 317-328.
- [4] Vaitkus, A., Vorobjovas, V., Grazulyte, J., Kleiziene, R., Šernas, O., Jonusaitė, A.: Design Solutions for Pavements Structure Affected by Static and Impact Load. *The Baltic Journal of Road and Bridge Engineering* 9 (2014), pp. 269-275, doi: 10.3846/bjrbe.2014.33
- [5] Vaitkus, A., Vorobjovas, V.: Use of Local Aggregates in High Modulus Asphalt Concrete Layers, *Gradevinar*, 65 (2013), pp. 353-360.
- [6] Ghavibazoo, A., Abdelrahman, M., Ragab, M.: Effect of CRM Dissolution on Storage Stability of CRM Modified Asphalt, 92th Annual Meeting of the Transportation Research Board, pp. 1–14, 2013.
- [7] Zeinali, A., Blankenship, P. B., Mahboub, K. C.: Comparison of Performance Properties of Terminal Blend Tire Rubber and Polymer Modified Asphalt Mixtures, *T&D Congress* (2014), pp. 239–248, doi: 10.1061/9780784413586.023
- [8] Shu, X., Huang, B.: Recycling of Waste Tire Rubber in Asphalt and Portland Cement Concrete: An Overview, *Construction and Building Materials* 67 (2013), pp. 217–224. doi: 10.1016/j.conbuildmat.2013.11.027
- [9] Caltrans: Asphalt Rubber Usage Guide, pp. 1–71, 2006.
- [10] Takallou, H. B., Hicks, R. G.: Development of Improved Mix and Construction Guidelines for Rubber-Modified Asphalt Pavements, *Transportation Research Board*, Washington DC, pp. 113–120, 1988.

- [11] Hicks, G. R., Tighe, S., Tabib, S., Cheng, D.: Rubber Modified Asphalt Technical Manual, pp. 1–134, 2013.
- [12] Feiteira Dias, J. L., Picado-Santos, L. G., Capitão, S. D.: Mechanical Performance of Dry Process Fine Crumb Rubber Asphalt Mixtures Paced on the Portuguese Road Network, *Construction and Building Materials* 73 (2014), pp. 247–254, doi: 10.1016/j.conbuildmat.2014.09.110
- [13] Hassan, N. A., Airey, G. D., Ramadhansyah, P. J., Mashros, N., Aziz, M. M. A.: A Review of Crumb Rubber Modification in Dry Mixed Rubberised Asphalt Mixtures, *Jurnal Teknologi* 70 (2014), doi: 10.11113/jt.v70.3501
- [14] Moreno, F., Sol, M., Martín, J., Pérez, M., Rubio, M. C. C.: The Effect of Crumb Rubber Modifier on the Resistance of Asphalt Mixes to Plastic Deformation, *Materials and Design* 47 (2012), pp. 274–280, doi: 10.1016/j.matdes.2012.12.022
- [15] Hernández-Olivares, F., Witoszek-Schultz, B., Alonso-Fernández, M., Benito-Moro, C.: Rubber-Modified Hot-Mix Asphalt Pavement by Dry Process, *International Journal of Pavement Engineering* 10 (2009), pp. 277–288, doi: 10.1080/10298430802169416
- [16] Caltrans: Standard Specifications, 2015.
- [17] Ambaiwei, D. C., Tighe, S.: Rubberized Asphalt Mixtures With RAP: A Case For Use In Ontario, 94th Annual Meeting of the Transportation Research Board, pp. 1–14, 2015.
- [18] PN-EN 14023 :2011/Ap1: Classification of Polymer Modified Binders, pp 1–5, 2014.
- [19] FGSV: Recommendations for rubber-modified bitumen and asphalts (E GmBA 12), pp. 1–28, 2012.
- [20] Ministry of Transport: Technical Recommendation of the Ministry of Transport No 148 Asphalt Rubber pavement courses. TP 148, pp. 1–22, 2009.
- [21] Mandal, T., Teymourpour, P., Bahia, H. U.: Study on Devulcanization and Rheological Properties of Crumb Rubber-Modified Binders, 95th Annual Meeting of the Transportation Research Board, pp. 1–20, 2016.
- [22] Kim, S., Lee, S.-J., Yun, Y.-B., Kim, K.W.: The use of CRM-Modified Asphalt Mixtures in Korea: Evaluation of High and Ambient Temperature Performance, *Construction and Building Materials* 67 (2014), pp. 244–248, doi: 10.1016/j.conbuildmat.2014.02.074
- [23] Chen, M., Zheng, J., Li, F., Wu, S., Lin, J., Wan, L.: Thermal Performances of Asphalt Mixtures Using Recycled Tyre Rubber as Mineral Filler, *Road Materials and Pavement Design* 16 (2015), pp. 379–391, doi: 10.1080/14680629.2014.1002524
- [24] Ghavibazoo, A., Abdelrahman, M.: Effect of Crumb Rubber Dissolution on Low Temperature Performance and Aging of Asphalt-Rubber Binder, Transportation Research Board, 93rd Annual Meeting, pp. 1–14, 2014.
- [25] Kok, B.V., Çolak, H.: Laboratory Comparison of the Crumb-Rubber and SBS Modified Bitumen and Hot Mix Asphalt, *Construction and Building Materials* 25 (2011), pp. 3204–3212, doi: 10.1016/j.conbuildmat.2011.03.005
- [26] Sybilski, D., Bankowski, W., Horodecka, R., Czajkowski, P.: Laboratoryjna ocena przydatności polimeroasfaltu z dodatkiem gumy do zastosowania w mieszance AC WMS – część 2 – Badania mieszanek, *Drogownictwo* 9 (2014), pp. 300–306.
- [27] Subhy, A., Lo Presti, D., Airey, G.: An Investigation on Using Pre-Treated Tyre Rubber as a Replacement of Synthetic Polymers for Bitumen Modification, *Road Materials and Pavement Design* 16 (2015), pp. 245–264, doi: 10.1080/14680629.2015.1030826
- [28] Lotos Asfalt: Asfalty modyfikowane z dodatkiem gumy do trwałych nawierzchni asfaltowych, 2014.





## MECHANISTIC ASPHALT OVERLAY DESIGN METHOD FOR HEAVY DUTY PAVEMENTS

Zoltán Soós<sup>1</sup>, Zsuzsanna Igazvölgyi<sup>2</sup>, Csaba Tóth<sup>1</sup>, László Pethő<sup>2</sup>

<sup>1</sup> *Budapest University of Technology and Economics, Hungary*

<sup>2</sup> *ARRB Group, Australia*

### Abstract

The current Hungarian overlay design manual was developed in the 1990s and no major review has been conducted since then. Therefore the technological and material advances e.g. modified binders and mixes, high modulus mixes, use of reclaimed asphalt pavements, asphalt grids and nets, compromises with local resources, changes in traffic loading and volume, cannot be incorporated in the calculations and the design method is considered outdated in many ways. The current methodology enables two options for the asphalt overlay design, the deflection and the pavement condition criteria. There are cases when the overlay is necessary primarily due to the condition of the asphalt layer(s), and not due to the lack of structural capacity. In such cases, i.e. when a thick existing asphalt layer is to be strengthened – primarily at highways and heavily trafficked roads – the difference between the two methods may be considerable, implying there is an error in either method, or the special circumstances require special considerations.

In this paper a researcher group at the Budapest University of Technology and Economics presents a new, mechanistic approach for overlay design. The proposed method is based on statistical analysis of Falling Weight Deflectograph (FWD) measurements, followed by the determination of the analytical input parameters either by laboratory tests or back-calculation of FWD data. Then the strains at the bottom of the asphalt layers are calculated using Odemark's transformation and the method of equivalent thicknesses. The required asphalt overlay thickness is calculated based on the allowable strains and the strains calculated for varying thicknesses.

The proposed method is presented using FWD measurements, core test results and traffic loads of a motorway in service. The method, followed by field calibration, may be an answer to the problems presented, as analytically incorporating the parameters of each material, and taking into account the remaining life of the existing pavement.

*Keywords: deflections, strains, overlay, method of equivalent thicknesses*

### 1 Introduction

The current Hungarian pavement and overlay design methods date back to a professionally advanced period of the Hungarian pavement engineering. Despite the former world-class state of the Hungarian practice, besides some minor updates the design guides have not been further developed since the 1990s. As there were intensive developments regarding the primary road network in the past decades in Hungary, in the near future the nearly completed network is expected to face a dramatically growing need for rehabilitation on a significant length of the network.

The road construction industry, facing a constant lack of funds, finds itself in an environment where both new and strengthened roads must face increasing traffic and climatic loads and the need for a proper, mechanically based design method which enables the efficient utilization of financial and material resources is inevitable. The design method of new pavements and overlays should be able to incorporate innovative technologies and new materials developed since the development of the guide. These new technologies, though they are readily available, cannot be taken into consideration at the design stage. There have been attempts to renew the current design methods ([1-4]); however, the pavement design guides have not been revised yet.

In this paper the authors present a mechanistic approach of the overlay design, being under development at the Budapest University of Technology and Economics, as an alternative to the current guide. The method proposed has been previously tested on actual pavement design tasks and is constantly being refined to achieve a thorough design procedure.

## 2 Critical review of the current overlay design method

### 2.1 Overlay design based on deflections

The Hungarian standard e-UT 06.03.13 (2005) imposes overlay design primarily based on static deflections measured on the existing pavement surface. The deflections should be corrected according to the pavement temperature and a seasonal factor which considers the probable moisture content of subbases for various soil types. Dynamic deflectographs may be used; however, in this case the “d” dynamic deflections should be converted to “s” static deflections according to the rather simple Eq (1). Unfortunately only deflections measured at the loading point are considered instead of the whole deflection bowl.

$$s \text{ [mm]} = 1,2 \cdot d - 0,08 \quad (1)$$

Issues regarding the accuracy of the various correctional factors, and the method of conversion to static deflections are not discussed in this paper. Based on deflections the analysed road section is divided into homogenous segments using the cumulative sum method [5]. Such segments are assumed to have statistically similar in terms of load bearing capacity and thus the calculated overlay thickness and technology will be constant within a segment. Design deflection “ $s_m$ ” is calculated for each homogenous section considering reliability factors. Design traffic is calculated in 100 kN ESALs for a design life of 10 (low volume roads) to 20 years (highways). Based on fatigue curves determined for extremely flexible, flexible and semi-rigid pavements the allowed deflections may be determined. The required (minimal) overlay thickness is determined using graphs based on the measured and the allowed deflections.

### 2.2 The comparative method

There are cases where the measured deflections are so low that the method discussed in Section 2.1 gives uninterpretable results. In these cases, provided the design traffic exceeds 1 million ESALs, the comparative method may be applied. The method considers a “v” reduction factor between 0,40-1,00 (based on the visual assessment of the pavement surface) for the “ $h_{ap}$ ” thickness of the existing pavement as well as the thickness of milling “ $h_{ae}$ ”. In this case the “ $\Delta h_a$ ” overlay thickness is calculated according to Eq.(2):

$$\Delta h_a \text{ [mm]} = h_{au} - h_{ae} + h_{ap} \cdot v \quad (2)$$

In Eq. (2) the method uses the asphalt thickness from the pavement design catalogue for new pavements according to the design traffic calculated for the required design life of the overlay.

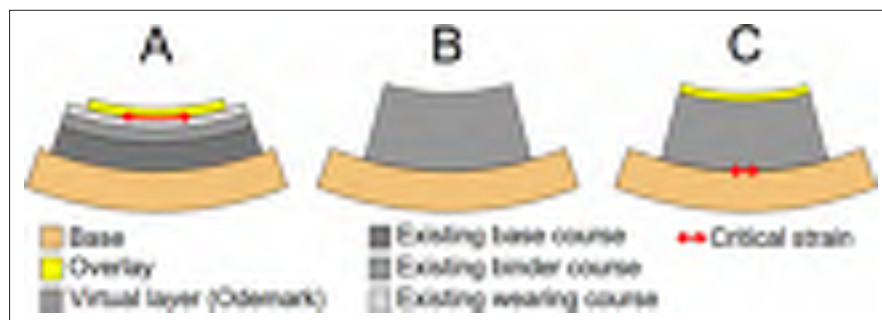
The pavement catalogue and the deflection curves presented in the standard were developed in the 1990's and are practically the same today apart from minor updates. As seen the current methods are quite conservative with respect to the technological and modelling power available today.

The methods assume that the bond between the old and the new asphalt layers will weaken shortly after construction thus the critical strains that determine fatigue life of the strengthened pavement will occur at the bottom of the overlay. In this case the existing structure will only marginally lower strains as compared to a full friction between the old and the new layers. Such loss of bond is not obvious, especially when analysing pavements with thick asphalt layers and good load bearing capacity. In addition, the pavement catalogue and the deflection curves are statically provided, meaning there is no possibility to assess the effect of modern asphalt mixes and special technologies, nor material parameters of special asphalt mixes made with various additives that are however commonly used.

### 3 Background and outlines of the proposed method

#### 3.1 Mechanical model

The proposed mechanical model is based on the Odemark-Ullidtz method of equivalent thicknesses (MET) [6]. A rather important assumption of the authors counter to the current theory is that the bond between the overlay and the existing structure will be adequate for the layers to interact. This is likely in cases where a thick existing asphalt layer is available and the bearing capacity of the existing structure is relatively high (e.g. typically the primary road network). Accordingly, the presented method itself is proposed for such cases. According to the assumption the critical strains that cause fatigue failure will occur at the bottom of the existing asphalt layer (Figure 1 C), and will be significantly reduced as compared to the modelling applied in the current standard (Figure 1 A).



**Figure 1** Position of critical strains: (A) Current standard method (B) Odemark transformation (C) Proposed method

The model consists of 3 layers, namely the asphalt layers, the subbase and the subgrade. The required material parameters are the stiffness moduli, the Poisson's ratio and the thickness of each layer (the subgrade is of infinite thickness). The existing asphalt layers and the overlay are cumulated using Odemark's transformation [7] based on the equality of the  $E^*$  flexural momentum of the layers (Figure 1 B). The calculation of the virtual thickness " $h_{e,n}$ " of a given layer having an actual thickness " $h_i$ " and moduli " $E_i$ ", to a virtual moduli " $E_n$ " is according to Eq. (3).

$$h_{e,n} = f \cdot \sqrt[3]{\sum_{i=1}^{n-1} h_i^3 \cdot \left( \frac{E_i}{E_n} \right)} \quad (3)$$



### 3.2 Critical strains

Applying MET, strains occurring at the bottom of the asphalt layers can be calculated for a range of asphalt thicknesses which consist of the existing layers and a varied overlay thickness, cumulated using Odemark's transformation. As a result the thickness-strain curves based on actual material properties are determined. Strains occurring at a given "z" depth in a given asphalt layer are calculated according to Eq. (4), based on the stiffness moduli "E" and the Poisson number "ν" of the layer, the radius of the loadin plate "a":

$$\epsilon_z = \frac{(1+\nu) \cdot \sigma_0}{E} \cdot \left[ \frac{\frac{z}{a}}{\left( \sqrt{1 + \left( \frac{z}{a} \right)^2} \right)^3} \cdot (1-2\nu) \cdot \left( \frac{\frac{z}{a}}{\sqrt{1 + \left( \frac{z}{a} \right)^2}} \right) \right] \quad (4)$$

In terms of critical strains to cause fatigue failure, paramter "z" is equal to the thickness of the asphalt layers.

### 3.3 Allowed strains

Allowed strains for a given design traffic (the number of 100 kN ESALs) can be calculated based on laboratory fatigue tests for a given asphalt mix, or according to known prediction formulas, e.g. the SHELL fatigue equations [8]. Previous research [9] at the Department involving fatigue tests of core samples showed that the SHELL equations slightly underestimate the real fatigue performance of old asphalt layers. Due to its approximation to the benefit of reliability, the SHELL formula, based on the "V<sub>b</sub>" binder volume, the "E<sub>e</sub>" stiffness of the mix and "N" design traffic in ESALs is used according to Eq. 5.

$$\epsilon_t = (0,856 \cdot V_b + 1,08) \cdot E_e^{-0,36} \cdot N^{-0,2} \quad (5)$$

The required binder volume and stiffness values are determined via laboratory tests. As a result the allowed strains or each homogenous segment may be calculated in microstrains.

## 4 Calculations

The proposed mechanical overlay design method is presented below step-by-step for a highway section in Hungary based on actual measurements.

### 4.1 Evaluation of FWD data

For the proposed method, unlike the standardised method, the whole deflection bowl will be assessed. The deflection bowl obtained using KUAB FWD measurements consists of an overall 7 points. Measurements were taken in both directions in the most heavily trafficked slow lane every 50 meters. As there are some disputes about the current seasonal and temperature corrections of dynamic deflections used in Hungary [10], the data is corrected using factors developed by Wagberg [11]. Both directions are divided into homogenous segments using the same method as in the standard. Figure 2 shows the cumulative sum values for both directions.

Homogenous segments are determined via calculation, according to the changes in the trends of the CUSUM curves. As shown three segments can be determined for each directions.

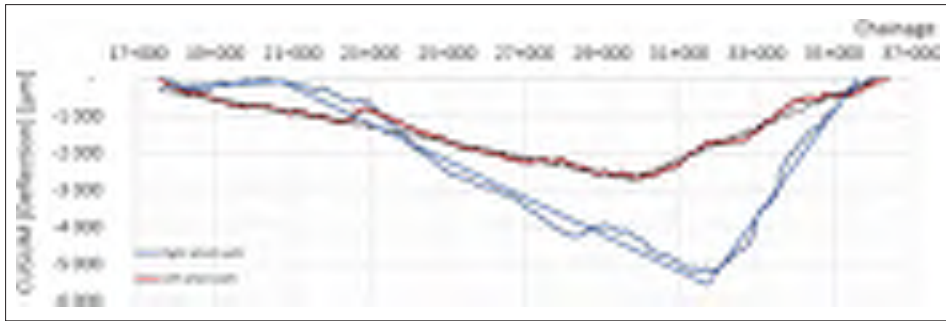


Figure 2 Cumulative sum values for both directions

#### 4.2 Characterisation of a section

Within each homogenous segment the significantly weak sections, based on deflections, are identified using the area parameter developed by Adorjányi [12]. The parameter is calculated using the deflection bowl, and the higher its value, the higher the ratio of the pavement is involved in carrying the loading. The calculation of the area parameter “TP”, using deflections measured at given “ $d_i$ ” sensors placed at “ $i$ ” distances from the loading plate, is according to Eq. (4).

$$TP = \frac{1}{12} \cdot [d_0 + 1,25 \cdot d_{300} + 2,25 \cdot d_{600} + 1,5 \cdot (d_{200} + d_{450} + 2 \cdot d_{900} + d_{1200})] \quad (4)$$

The area parameter is calculated for every deflection bowl. The representatively weakest section within a homogenous segment is assumed to have the 95% frequency of occurrence of the highest area parameter. Using this method it is possible to detect a section being weak in a general sense, as compared to the central deflections, which primarily indicate the condition of the asphalt layers.

#### 4.3 Core samples and material parameters

Core samples were taken at the representative cross-section determined for each homogenous segment. The samples provided actual thickness data and optionally material parameters may be determined via laboratory tests. Required material parameters for the mechanistic model may be also determined using back-calculation of FWD data as presented in [13]. In this paper the material properties of the asphalt layers were determined using indirect tensile strength test (IT-CY) according to EN 12697-26 (method C), the moduli of the subbase and the subgrade were determined by back-calculation of the deflection data using EVERCALC software. Layer thicknesses and properties are shown in Table 1.

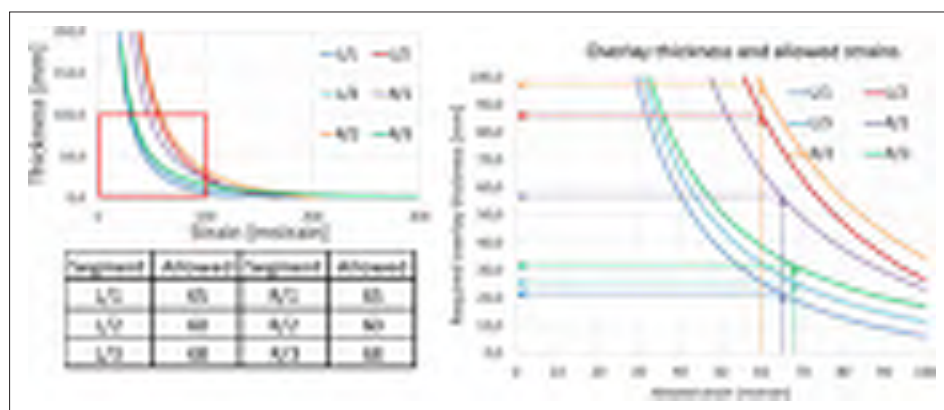
According to previously discussed boundary conditions of the proposed method in this case the wearing course is assumed to be milled out and is not considered in the modelling. Based on Odemark’s transformation the binder and base asphalt layers are transformed into a virtual layer with the moduli of the base course. The model of the existing structure consists of the three highlighted layers shown in Table 1.

**Table 1** Thicknesses and material properties of existing layers

Homogenous segment	Left track			Right track		
	L/1	L/2	L/3	R/1	R/2	R/3
Representative section	21+000	27+174	31+750	18+750	28+600	33+550
Wearing course	32 mm	41 mm	38 mm	59 mm	43 mm	50 mm
Binder course	77 mm	84 mm	70 mm	80 mm	82 mm	82 mm
	3563 MPa	3631 MPa	3104 MPa	4341 MPa	4209 MPa	3265 MPa
Base course	125 mm	109 mm	118 mm	110 mm	78 mm	96 mm
	4214 MPa	6561 MPa	3881 MPa	5145 MPa	6806 MPa	3170 MPa
Asphalt layers (Odemark; binder and base course)	198 mm	178 mm	183 mm	186 mm	148 mm	179 mm
	4214 MPa	6561 MPa	3881 MPa	5145 MPa	6806 MPa	3170 MPa
Subbase	250 mm	250 mm	250 mm	250 mm	250 mm	250 mm
	1996 MPa	1117 MPa	1115 MPa	856 MPa	1173 MPa	265 MPa
Subgrade	178 MPa	166 MPa	159 MPa	179 MPa	209 MPa	155 MPa

## 5 Results and discussion

Using the calculated thickness-strain curves for each homogenous segment and the allowed strains based on the calculated design traffic the required overlay thickness can be easily determined, as shown on Figure 3. The design was conducted according to the current standards for comparison, however, as the measured deflections are low, the method based on deflections resulted in uninterpretable results.



**Figure 3** Determination of required overlay thickness

The required overlay thicknesses for each homogenous segment, assuming AC11 50/70 wearing course with a moduli of approximately 4500 MPa, and using the model described, are shown in Table 2. As expected, calculations based on the actual parameters of the existing structure and the overlaying asphalt mix result in a significantly lower overlay thickness in all cases.

The proposed method is under fine tuning and has been tested on various pavement types based on actual measurements and laboratory tests. Further calibration of the method is however required, such as the corrections of the measured deflections especially in light of the changing climatic factors [14], or the correct calculation of the design traffic and integration of WIM data into the parameters used. The method itself has shown in previous and this actual

research that due to its simplicity it is a viable alternative to the currently used methods. Further research will be conducted to establish the limitations of the system and to develop a framework for an eventual transition period between the current and the proposed method.

**Table 2** Overlay thicknesses calculated for each homogenous segment

Homogenous segment	Left track			Right track		
	L/1	L/2	L/3	R/1	R/2	R/3
Representative section	21+000	27+174	31+750	18+750	28+600	33+550
Design traffic [100 kN ESALs]	18 306 566	25 881 098	14 108 131	18 306 566	25 881 098	14 108 131
Allowed strain (SHELL formula)	65 mstrain	60 mstrain	68 mstrain	65 mstrain	60 mstrain	68 mstrain
Overlay (mechanistic)	21 mm	86 mm	26 mm	57 mm	97 mm	32 mm
Overlay (comparative)	95 mm	139 mm	93 mm	116 mm	144 mm	93 mm

## References

- [1] Adorjányi, K.: Aszfaltburkolatú útpályaszerkezetek megerősítésének méretezése ejtősúlyos behajlások alapján, KÖZÚTI ÉS MÉLYÉPÍTÉSI SZEMLE: AZ ÚTALAP ÉS A KÖZLEKEDÉSTUDOMÁNYI EGYESÜLET LAPJA XLIX/12, pp. 495-499, 1999.
- [2] Bocz, P., Devecseri, G., Fi, I., Pethő, L.: Pályaszerkezetek analitikus méretezése, Közlekedésépítési szemle LIX./5, pp. 8-22, 2009.
- [3] Fi, I., Szentpéteri, I.: A Mechanistic-Empirical Approach for Asphalt Overlay Design of Asphalt Pavement Structures. doi: 10.3311/PPci.7408, Periodica Polytechnica Civil Engineering LVIII/1, pp. 55-62, 2014.
- [4] Fi, I., Szentpéteri, I.: Aszfalt pályaszerkezetek megerősítés méretezésének mechanikai-empirikus módja, MAGYAR ÉPÍTŐIPAR LXIV/3, pp. 114-119, 2014.
- [5] COST 336, Use of Falling Weight Deflectometers in Pavement Evaluation, 2005.
- [6] Ullidtz, P.: Modelling flexible pavement response and performance, 1998.
- [7] Pronck, A.C.: Equivalent layer theories. State of the art report, 1994.
- [8] SHELL, SHELL Pavement Design Manual: Asphalt Pavement and Overlays for Road Traffic, SHELL International Petroleum Company LDT. London, UK, 1978.
- [9] László, P., C. Tóth, C.: Long-term pavement performance evaluation, Proceedings of the 7th RILEM International Conference on Cracking in Pavements, pp. 267-276, 2012.
- [10] Karoliny, M.: Behajlásmérési idősorok elemzése, Útügyi Lapok: A Közlekedésépítési Szakterület Tudományos és Szakmai Folyóirata (online), 2014.
- [11] Wagberg, L.G.: Utveckling av nedbrytningmodeller, VTI Neddelande 916, 2001.
- [12] Adorjányi, K.: Bemenő paraméterek bővítése az aszfaltburkolatú pályaszerkezetek méretezésénél, Közlekedésépítési szemle 59. évf. 7. szám, pp. 11-17, 2009.
- [13] Soós, Z., Tóth, C., Szentpéteri, I., Pethő, L.: Advanced pavement overlay design using the general mechanistic method, Proceedings of the Second International Conference on Infrastructure Management, Assessment and Rehabilitation Techniques, pp. 88-94, 2015.
- [14] Szentpéteri, I., Tóth, C.: Effects of climatic factors on the shape of deflection bowl, Road and Rail Infrastructure III. Proceedings of the 3rd International Conference on Road and Rail Infrastructure - CETRA 2014, 28-30 April 2014, Split, Croatia
- [15] e-UT 06.03.13 [ÚT 2-1.202:2005]: Aszfaltburkolatú útpályaszerkezetek méretezése és megerősítése, Magyar Útügyi Társaság, p. 34, 2005.





## ACTUAL EFFICIENCY OF ROAD PAVEMENT REHABILITATION

László Gáspár

*KTI Institute for Transport Sciences Non-Profit Ltd., Hungary*

### Abstract

Most European countries, including Hungary have already practically completed the development of highway network (excluding the construction of new motor-way sections and bypasses). Instead, the real challenge is the condition pre-servation of existing road network, among others, by properly planned, designed and executed pavement rehabilitation. This is the reason why the knowledge on the actual efficiency of various road rehabilitation techniques can be considered of utmost importance. 60 trial sections selected of Hungarian national highway network in 1991 have been yearly monitored since then. (Condition parameters systematically characterized are: bearing capacity, longitudinal and transversal unevenness, micro and macro texture, surface defects). However, the main aim of the already 25-year-old pavement monitoring is the development of ever im-proving pavement performance models for several road management purposes (done by KTI Institute for Transport Sciences Non-Profit Ltd., Budapest in a continuous research work) the condition data time series obtained can be utilized also for the evaluation of the actual road pavement rehabilitation techniques in Hungary. During such a long (25-year) monitoring period, it is obvious that almost every trial section ought to be rehabilitated (using surface dressing, thin asphalt layer, pavement strengthening) at least once. Since the monitoring of re-habilitated sections have continued after their condition improving intervention, the following information types could have been collected: actual condition level at intervention, actual condition improving effect for various condition parameters and deterioration trend in the pavement life cycle after rehabilitation compared to the previous one(s). KTI has carried out this kind of analysis, and can give information on the actual efficiency of various road pavement rehabilitation in Hungary for 14 combinations of pavement structure type (flexible, super-flexible, semi-rigid), traffic size (heavy, medium and light) and subgrade soil type (granular, intermediate, cohesive) based on the case studies performed.

*Keywords: road rehabilitation, efficiency of road rehabilitation, trial section monitoring, pavement condition parameter, pavement life cycle*

### 1 Introduction

Most European countries, including Hungary have already practically completed the development of their highway networks (excluding the construction of new expressway sections and bypasses). Instead, the real challenge is the condition preservation of existing road network, among others, by properly planned, de-signed and executed pavement rehabilitation. This is the reason why, the know-ledge on the actual efficiency of various road rehabilitation techniques can be considered of utmost importance. 60 trial sections of 500 m length selected of Hungarian national highway network in 1991 have been yearly monitored since then [1]. During such a long (25-year) monitoring period, it is obvious that almost every tri-al section ought to be rehabilitated. Since the monitoring of rehabilitated sections have continued after the condition improving intervention, the following informa-tion types could

have been collected: actual condition level at intervention, actual condition improving effect for various condition parameters and deterioration trend in the pavement life cycle after rehabilitation compared to the previous one(s) [2]. The results of this research effort will be subsequently summarized, and discussed.

## 2 Trial section monitoring in Hungary

In Hungary, 60 sections of the public road network of “normal” traffic have been systematically monitored since 1991. The time data series of several condition parameters obtained from the test sections, made it possible to develop highway performance models for several pavement structural, traffic and environmental variants [3]. Semi rigid, flexible and super-flexible (macadam-type, unbound base) structure categories, three traffic categories (max 2,000 pcu/day, 2,001-5,000 pcu/day, min 5,001 pcu/day) and three environmental (subsoil type or bearing capacity) classes were considered. The realistic variants (combinations) of the parameters mentioned were represented by 4-6 test sections. The following condition parameters of the 500-m long trial sections have been evaluated, and analysed:

- Longitudinal unevenness (IRI using laser RST)
- Rut depth (using laser RST)
- Macro texture (using laser RST)
- Micro texture (using laser RST)
- Bearing capacity (using KUAB falling weight deflectometer)
- Surface defects (visual evaluation aided by keyboard apparatus Road Master).

Besides, the traffic parameters of, and the major maintenance (rehabilitation) actions on all sections have been collected. The major goal of trial section monitoring is the development of pavement performance models, the average (typical) deterioration curves in a structure-traffic-subsoil type combination. The performance models of the road categories can be attained by putting regression curves on the points representing condition parameter levels as a function of time. (Similar curves are determined as a function of the traffic passed). The function types applied in the development of the HDM-III model organised by the World Bank [4] were selected for the condition parameters. (Exponential functions were chosen for unevenness and rut depth, while linear functions for the other condition parameters monitored). The performance models for each road category and each condition parameter have been determined, every monitoring year, utilising also the latest condition information. Box-Whiskers test is applied to select and to exclude the outliers of the data series analysed [1].

No determined trends could be found for bearing capacity parameters (deflection value or stiffness modulus) yet as a function of time or traffic passed. The seasonal and the yearly strength fluctuations due to environmental reasons seem to be more pronounced than the fatigue of pavement structures.

## 3 Pavement rehabilitations on trial sections

The trial section monitoring in Hungary has been performed since 1991. During this 25-year period, a considerable share of the sections deteriorated to such an extent that some kind of rehabilitation (surface dressing, resurfacing or strengthening) was needed. It was decided to go on with the regular condition evaluation since the additional survey could provide other kinds of useful information. The condition parameter levels in the years before and after the intervention can be utilised for the determination of the actual condition improving effect of various major maintenance techniques. Furthermore, the continuation of trial section monitoring for several more years can provide information about the deterioration trends after the intervention which can be compared to the tendencies during the former life cycle(s).

Between 1991 and 2015, 55 pavement sections (that is 92 % of the 60 trial sections) were rehabilitated. Altogether 37 projects with pavement strengthening, 9 thin asphalt layers and 20 double bituminous emulsion surface dressings were built. (11 sections had two interventions during the period mentioned).

In group “pavement strengthening”, the overlaying above 40 mm asphalt layer thickness is taken into consideration. The effects of strengthening on surface defects, unevenness, rut depth, macro texture and micro texture were analysed.

In the group “resurfacing using thin asphalt layers”, the consequences of the same condition parameters were evaluated as in pavement strengthening group. For the surface dressed trial sections, mainly the changing in surface defects, macro and micro textures were evaluated; however, its influence to rutting and IRI-values was not disregarded, either.

#### 4 Condition level before rehabilitation

Pavement management systems usually utilize intervention levels that are the given condition parameter values below which pavement operation is not economical any more [5]. These levels are, of course, different in various road types (e.g. 2.5 m/km IRI-value on motorways). Since the actual values of intervention levels constitute a basic PMS information, their validation is of utmost importance. The long-term monitoring of trial sections offered a good opportunity for this validation.

There is here another important fact to be considered: the deterioration speeds of various pavement condition parameters are usually not identical. When the “most rapid” of them, the critical parameter reaches its intervention level – and thereby necessitates pavement rehabilitation – other parameters are still at a relatively appropriate level, at which the condition improving rehabilitation actions are not needed yet. (However, the typical rehabilitation techniques improve the actual condition of all parameters including the ones that are still at an acceptable level [4]). The analysis of trial section performance data makes it also possible to gather information on the critical condition parameters of different road types that can be considered as a basic knowledge for the further development of national pavement design theory and practice. Similarly, the actual levels of critical parameters before the condition improving actions coming from trial section monitoring are important piece of knowledge.

The ages of trial section wearing courses before strengthening were between 4 and 31 years. The most frequent pavement age happened be in the range of 11-15 years; however, 6 cases with 6-10 years, 4 cases with 16-20 years and 5 cases between 20-24 years were registered. (The pavement ages less than 6 years and above 24 years happened to be just exceptional). The longitudinal unevenness, IRI-values of trial section pavements to be rehabilitated were usually in the range of 1.1-2.6 m/km. (The only exception was an asphalt macadam pavement with 7.1 m/km IRI-value).

In case of thin asphalt layers, old wearing course ages and IRI-values were similar to those of pavement strengthening. Rut depth range of trial sections before pavement strengthening took place between 1.5 and 14.8 mm. It is obvious that, in the cases with 1.5-5.0 mm rut depth, some other pavement condition parameter was the critical one necessitating rehabilitation. The condition data time series of trial sections have validated the previous expectation according to which no thin asphalt layer can be effective if rut depth of old pavement surface exceeds 10 mm.

The initial longitudinal unevenness of trial section before surface dressing happened to be 1.8-3.6 m/km IRI-value on main roads and 4.0-6.0 m/km on secondary roads. The initial average rut depth amounted to 2.0-4.5 mm on main roads and 2.0-9.0 mm on secondary roads. The rather wide range of the macro texture of “old” pavement surface amounted to between 0.20 and 0.65. The mass of micro textures proved to be more homogeneous, with 0.13 and 0.38 extreme values.



## 5 Actual condition improving effect of pavement rehabilitation

Figure 1 shows the effect of pavement strengthening on the visual condition state (characterisation of surface defects). It can be seen that the originally medium-poor condition level (grades 3-5) changes into excellent (grade 1) or good (grade 2) one. The five points in Figure 1 actually represent information about 16 sections, since the variant 4→1 occurs seven times, and 5→1 three times, while the variants 4→2, 3→1 and 5→2 twice. So, the results are close to the expected ones: 75 % grade 1 and 25 % grade 2. (The not fully perfect condition state, a single year after the construction, refers to quality problem during the execution).

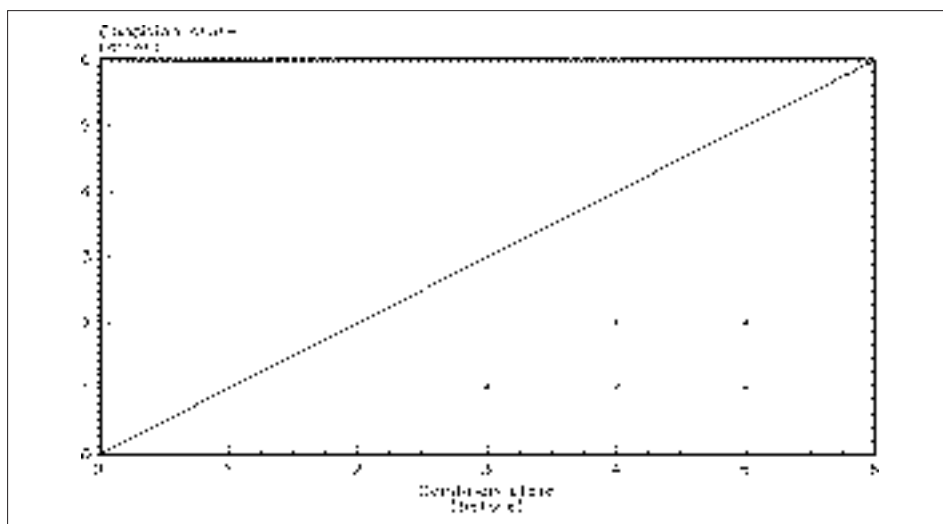


Figure 1 Effect of strengthening on surface defects (visual condition state)

Before and after surface dressing, all of the condition parameters mentioned before were collected, and evaluated. The changing of texture parameters was considered of high importance [6]. The following consequences could be drawn:

- surface dressing is usually able to improve macro texture to a higher degree than surface micro texture (both parameters were characterized by dimensionless parameters measured by laser RST),
- usually an improvement by 0.10-0.20 could have been attained in macro roughness, however, in two cases, much higher (0.43-0.78) increases were reached,
- on one of the trial sections, a slight worsening of macro texture was observed, although, this case, the initial surface macro texture had been rather high (0.46),
- typically, 0.05-0.13 micro texture improvement could be detected after surface dressing; however, an increase of 0.22 and another one of 0.41 were observed (in this latter case, there has been an extreme improvement in macro texture, as well),
- it is worthwhile to mention that, on the trial section where macrotexture worsened after surface dressing, micro texture also decreased slightly (by 0.01).

## 6 Deterioration trends before and after rehabilitation

The deterioration of pavements after rehabilitation, e.g. strengthening without milling old layer(s) depends on various, partly controversial factors, among others, thickness and quality of new asphalt layer(s), the quality of remaining, old pavement layers and the traffic progression factors. The actual deterioration (and duration of new life cycle) is originated from the

combination of influencing parameters. The deterioration features of two typical trial sections – as case studies – are compared before and after the condition improving intervention (pavement strengthening or surface dressing).

Figure 2 presents the deterioration curve of a trial section showing the trends before and after a pavement strengthening done in 2002. The trends of surface defects (“Rbal”), rut depth (“Knyom”) and IRI are shown on the figure [1]. The following statements can be made when comparing the deterioration curve “parts” of various condition parameters before and after the intervention in 2002:

- surface defects characterized by Road Master aided, 5-graded visual inspection reached the worst (5) score in the “before” life cycle already at the age of 11 years (the trial section had been constructed in 1989), while the deterioration during “after” life cycle is considerably slower showing still a medium condition level (grade 3) after 12 years in 2014;
- the average rut depth of the section in 2 years before the pavement strengthening – at the age of 11-13 years – was around 8 mm, the same level was attained after 10 years in the “after” life cycle proving the similarity of the two rut depth progression trends;
- trend of IRI values is practically not influenced by the pavement rehabilitation, since it is continuously around 2 m/km proving that longitudinal unevenness constitutes very rarely the critical condition parameter of Hungarian main roads with relatively thick pavement structure.

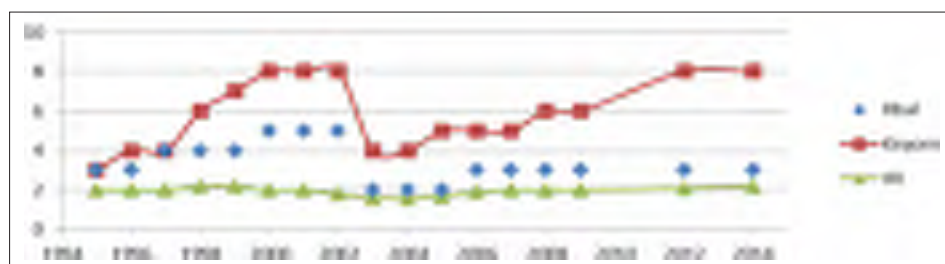


Figure 2 Deterioration curve of a trial section before and after a pavement strengthening in 2002

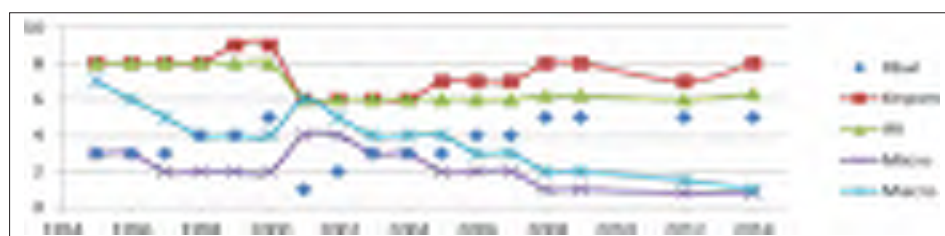


Figure 3 Deterioration curve of a trial section before and after a surface dressing in 2001

Figure 3 shows the deterioration curve of a trial section before and after a surface dressing in 2001. (A former surface dressing was carried out in 1992). The trends of surface defects (“Rbal”), rut depth (“Knyom”), IRI, micro roughness and macro roughness are shown [1]. The following statements can be made when comparing the deterioration curve “parts” of various condition parameters before and after the intervention in 2001:

- during the “before” life cycle, the worst (5) grade of surface defects had been reached in 2000, at the age of 8 years, while, in the “after the surface dressing in 2001” life cycle, the same poor condition level surface was attained at the age of 7 years (2008), that is the deterioration trends of surface defects during the two life cycles are similar to each other;
- 8-9 mm rut depth could be measured at the age of 8-9 years, at the end of the “before” life cycle, similarly, 7-8 years were needed in the “after” life cycle to attain the same level (it

- should be also emphasized that the surface dressing could reach, not surprisingly, just a reduction of 3 mm in the average rut depth);
- the second period of “after” life cycle was characterized by a rather high (8 m/km) average IRI-value, the pavement rehabilitation by surface dressing can reduce IRI by 2 m/km, and, a bit surprisingly, this 6 m/km value was measured, almost unchanged, during the first 13 years of the “after” life cycle; in such a way, a significant improvement can be seen in the second life cycle (the reason can be the effective and durable waterproofing effect of the double surface dressing);
  - the dimensionless micro texture parameter measured by laser RST had reached the rather poor (0.2) level at the age of 6-8 years, at the end of the “before” life cycle, surface dressing had improved its value to the level of 0.4 that have deteriorated to 0.2 in 4-5 years, and even to an extremely poor level of 0.1 in 7-8 years proving that surface dressing could not fulfil one of its main tasks, the durable improvement of surface micro texture;
  - the dimensionless macro texture parameter measured by laser RST had reached the level of 0.4 at the age of 6-8 years, at the end of the “before” life cycle, surface dressing had improved its value to the reasonable level of 0.6 that have deteriorated to 0.4 in 2-3 years and to a poor level of 0.2 in 7-8 years, and even to an extremely poor level of 0.1 in 12-13 years proving that surface dressing could not fulfil one of its main tasks, the durable improvement of surface macro texture.

## 7 Conclusion

Based on the results of the two trial section case studies (Figures 2 and 3), the following general statements can be made:

- the typical condition parameters of Hungarian asphalt pavements (the very poor levels of which necessitate rehabilitation actions) are surface defects and/or rut depth;
- the actual condition state of a critical parameter at the time of rehabilitation is usually below the “official” intervention level specified in relevant standards or technical directives due to the typical shortage of financial means available in road sector;
- the actual condition improvement in various parameters covers a rather wide range depending mainly on the quality level of old structure, design and construction features; the “rehabilitated” condition very rarely reaches that of the original, newly built pavement;
- deterioration trends before and after pavement rehabilitation are typically similar; however, local extreme traffic, design, construction, maintenance and/or climatic conditions can induce basic differences between them.

## References

- [1] Gáspár, L. (research manager): Útgyazdálkodási célú etalonszakasz-megfigyelés kiértékelése. (Analysis of the monitoring data of trial sections). Final report of KTI research project No. V-2015/627/2161-001-4-5, 102 p., 2015.
- [2] Gáspár, L.: Pavement condition before and after rehabilitation, *The International Journal of Pavement Engineering & Asphalt Technology*, 5 (2004) 1, pp. 15-25.
- [3] Gáspár, L.: Highway performance modelling, *International Conference on Developments in Road Engineering*, National Institute of Technology, Rourkela, India, pp. 24-36, 2011.
- [4] Paterson, W. D. D.: *Prediction of Road Deterioration and Maintenance Effects: Theory and Quantification*, Volume II, World Bank, Washington, D.C., 1986.
- [5] Gáspár, L.: *Útgyazdálkodás (Road management)*, Academy Press, Budapest, 324 p. 2003.
- [6] Gáspár, L.: Hungarian pavement performance models, *Ninth International Conference on Asphalt Pavements*, Copenhagen, 8 p., 2002.



## IN-SITU ASSESSMENT OF LOW NOISE ASPHALT PAVEMENTS ACOUSTICAL PERFORMANCE

Audrius Vaitkus, Viktoras Vorobjovas, Tadas Andriejauskas

*Vilnius Gediminas Technical University, Road Research Institute, Lithuania*

### Abstract

Paper presents Lithuanian low noise test road that consists of 9 different short sections constructed from recently developed low noise asphalt pavements for regional climate conditions (SMA5 TM, SMA 8 TM, TMOA 5), traditional asphalt mixtures (AC 11 VS, AC 8 PAS-H, SMA 8 S, SMA 11 S), porous asphalt mixture (PA 8) and special low noise asphalt product. After 6 months of exploitation, wide spectrum of measurements and tests were performed in-situ. Paper presents analysis and comparison of research results, collected after noise level measurements with Close Proximity (CPX) method. Despite the fact, that in every short section of test road both lanes were constructed of the same asphalt mixture, large noise level differences between the lanes were identified and could be associated with the installation heterogeneity. Analysis include CPX noise level values comparison for different low noise asphalt pavements with relation to surface texture pattern and properties, driving speed and vehicle/tire types.

*Keywords: Low noise pavements; test road; CPX measurements*

### 1 Introduction

In a recent decade, road transport noise problem and its negative impacts received huge attention from Road Authorities, City Municipalities and various organisations whose responsibilities more or less related with the noise abatement and mitigation. At the same time, increased attention fostered development and implementation of efficient road transport noise management solutions.

According to the EC calculations [1] annual EU socio-economic costs because of traffic noise are approximately 40 billion EUR and expected to increase 50 % by the 2050. It should be noted that these costs are mainly caused by the traffic of light and heavy duty vehicles. Negative impacts of road transport noise can be classified to three main groups [2, 3]: human related (sleep disturbance, annoyance, psychological stress, cardiovascular, mental state, hearing system, central nervous system, autonomous nervous system, learning/understanding/communication performance, work efficiency and other disorders or diseases); animal related (reproduction and migration of some animal species); economic related (real estate depreciation).

Vehicle generated noise can be divided into three noise sources (propulsion noise, tyre/road noise and aerodynamic noise) which are mostly dependent on the driving speed [4, 5]. At low speeds (up to 40 km/h) propulsion noise is a main contributor to overall vehicle noise while at the higher speeds (40-100 km/h) tyre and road interaction mechanisms contributes to approximately 90% of emitted acoustics energy and becomes dominant component in the vehicle noise context. At very high speeds, aerodynamic noise starts to be the main vehicle noise source.

Tyre/road noise is a dominant vehicle noise source in the cities or urban areas where negative noise impact is the highest. One of the most effective ways to reduce tyre/road noise is application of low noise asphalt mixtures [4-6]. Use of low noise pavement can be also substantiated by the fact that traditional noise mitigation solutions like noise walls/barriers, despite their good efficiency in noise reduction, are quite expensive to build and to maintain as well as the application in cities is not always possible due to various restrictions.

Low noise pavements has been used for a long time in Europe and huge efforts were made for the low noise asphalt mixtures development [4, 7, 8]. However, most of the experience is related with the porous asphalt mixtures which application in colder climate conditions is limited [9]. Therefore, the transferability of effective low noise pavement solutions from warm climate countries are questionable and not always efficient. For such reason, large research programme were initiated in Lithuania, with the main aim to develop low noise asphalt mixtures for regional climate conditions (approx. 60-80 annual frost-thaw cycles).

Development was started in the Road Research Institute (RRI) of Vilnius Gediminas Technical University (VGTU). Conventional SMA and AC mixtures were modified for noise reduction by optimising their surface texture (smaller max. aggregate size, concave texture) for tyre vibrations reduction and increasing air void content for better sound absorption [10]. Optimised low noise asphalt mixtures SMA 5 TM, SMA 8 TM and TMOA 5 were tested and compared with conventional asphalt mixtures SMA 8 S, SMA 11 S, AC 8 VS, AC 11 VS, AC 8 PAS-H, porous asphalt PA 8 and special patented noise reduction pavement [11]. Laboratory testing included determination of physical and mechanical properties, noise reduction properties (texture, sound absorption), durability properties and resistance to climate conditions. Positive and promising laboratory results led to the second research stage – pilot implementation and further low noise asphalt mixture assessment under real traffic and climate conditions.

## 2 Test road of low noise pavements

As it was indicated above, according to the laboratory testing results and estimations that developed low noise asphalt mixtures for regional climate conditions should reduce noise by 2-4 dBA, it was decided to construct test sections and perform further research of low noise pavements. The aim is to increase the level of living quality of population by testing low noise pavements in real traffic and environmental conditions, evaluating noise reduction characteristics dependent on asphalt mixture type and duration and level of exploitation.

Test Road of Low Noise Pavements was constructed in September, 2015 on a highway of national significance. Highway A2 Vilnius-Panevėžys is a two lane dual carriageway road which connects two large cities – Vilnius and Panevėžys. Test Road was constructed on a right side of the highway in the direction to Panevėžys at 56.07-57.57 km. Average annual daily traffic (AADT) in different parts of this highway varies from 7000 to 10000 vehicles per day. Speed limit is 110 km/h.

Test Road is 1.5 km in length and consists of 9 short sections where asphalt wearing layer was constructed using different asphalt mixtures. Those mixtures include 3 noise reducing asphalt mixtures (TMOA 5, SMA 5 TM, SMA 8 TM) developed by VGTU RRI for Lithuanian climate conditions, 1 porous asphalt mixture (PA 8), 1 special pavement and 4 traditional asphalt mixtures (SMA 8 S, SMA 11 S, AC 11 VS, AC 8 PAS-H). Main characteristics of the sections are presented in Table 1.

Such scope in variation of different pavement types is needed to perform long-term comparative monitoring of road surface characteristics, noise reduction properties, functional properties, resistance to climate conditions and durability between the different pavement types under real traffic and climate conditions.

**Table 1** Main characteristics of the Test Road of Low Noise Pavements

Pavement type	Layer thickness [cm]	Section length [m]	Pavement width [m]
PA 8	4.0	100	11,25-11,60
SMA 8 S	3.0	175	8,55-8,75
SMA 11 S	3.0	175	8,55-8,75
AC 11 VS	3.0	175	8,55-8,75
AC 8 PAS-H	2.5	175	8,55-8,75
TMOA 5	2.5	175	8,55-8,75
SMA 8 TM	2.5	175	11,25-11,60
SMA 5 TM	2.5	175	11,25-11,60
Special pavement	2.5	175	11,25-11,60

### 3 Monitoring and testing of low noise pavements

#### 3.1 Full measurements plan

Large set of periodic measurements in the Test Road of Low Noise Pavements are planned for the next 3 years: noise level measurements of passing vehicles using Statistical Pass-By (SPB) method (EN ISO 11819-1); tyre/road noise measurements using Close-ProXimity (CPX) method (ISO/DIS 11819-2); mean texture depth (MTD) measurements using volumetric patch method (EN 13036-1); mean profile depth (MPD) measurements using laser texture measurement devices, including measurements of RMS and skewness parameters; sound absorption measurements in impedance tube using standing wave ratio (EN ISO 10534-1); air void content and layer thickness measurements in laboratory (from the drilled cores); visual assessment. Measurements are performed annually: twice in spring (when average daily temperature is higher than 5°C and when average daily temperature is 10-15°C) and once in autumn (before the winter season). Before noise measurements, every section of the Test Road are being visually inspected to evaluate road pavement condition, identify pavement deterioration and all distresses.

#### 3.2 CPX noise level measurements

Tyre/road noise measurements in Test Road are performed using CPX method (ISO/DIS 11819-2). This method is based on test tyre rolling on the road or the test track surface with measuring microphones located close to the tyre surface.



**Figure 1** Fragment from CPX noise level measurements

Measurements are performed using CPX trailer (Figure 1) towed by a light vehicle. Trailer has two measurement wheels which are covered with the trailer case to isolate microphones from

unwanted outside sound sources, wind or traffic influence. Parallel to the CPX measurements, driving speed, road section length, GPS coordinates, air and road surface temperature are measured too.

CPX noise level measurements on both traffic lanes are performed at four different speeds: 40, 50, 80 and 100 km/h. Such measurement speeds are selected with a purpose to accurately determine road surface influence on noise generation mechanisms depending on the driving speed.

Two sets of measurement tyres to represent passenger cars and heavy duty vehicles were used. For passenger car representation standard reference test tyres (SRTT) are used and for heavy duty vehicle representation – Avon Supervan AV4 tyres (AAV4).

## 4 Analysis of the results

CPX noise level measurements were performed 1 month after Test Road of Low Noise Pavements construction. Measurement results for all short sections on both lanes at different driving speeds and with different sets of tyres are shown on Figure 2, 3, 4 and 5.

When comparing measurement results on 1<sup>st</sup> and on 2<sup>nd</sup> traffic lanes, it was found that differences between CPX noise level values of the same asphalt mixtures were not very high (less than 1.5 dBA) for almost all of the short sections. However, 1.5 dBA and higher differences between the traffic lanes were determined for the low noise asphalt mixtures PA 8, SMA 5 TM and SMA 8 TM. At very high speeds, differences were determined up to 2.5 dBA. Such big differences might be explained as a construction error (heterogeneity) – during wearing layer construction, mixtures on both lanes were compacted differently. Differences between the level of compaction on 1st and 2nd traffic lanes were 3-4%. As the noise reduction properties are strongly related with the air void content, over compaction of the mixtures with designed higher air void content, led to the large deviations in CPX noise levels.

Analysis of the CPX noise levels depending on the speed showed, that optimised low noise asphalt mixtures SMA 8 TM, SMA 5 TM and TMOA 5 and porous asphalt PA 8 have lowest CPX noise levels at all speeds and for both tyres (SRTT and AAV4). The highest noise levels were determined for SMA 11 S, SMA 8 S, AC 11 VS and special pavement.

Difference between the asphalt mixtures with highest and lowest CPX noise levels varies from 3 to 6 dBA, depending on the driving speed – higher the speed, higher the difference between the pavements.

Typically noise levels caused by the heavy duty vehicles are higher than passenger vehicles. Specific analysis of noise levels with both SRTT and AAV4 tyres were performed to investigate which asphalt mixtures are better for heavy duty vehicles noise reduction and which for passenger vehicles. Such analysis also was important to check if optimisation of SMA 5 TM, SMA 8 TM and TMOA 5 mixtures were done right – SMA 5 TM and TMOA 5 mixtures were designed with max. aggregate size of 5 mm (specifically for passenger vehicles noise reduction) and SMA 8 TM were designed with max aggregate size of 8 mm (for heavy duty vehicles noise reduction). Measured CPX noise levels confirmed the hypothesis – SMA 5 TM and TMOA 5 noise levels for SMA 5 TM and TMOA 5 with SRTT tyres approx. 2 dBA are lower than noise levels with AAV4 tyres.

From a surface texture point of view, according to the measured CPX noise levels, it can be stated that noise reduction for SMA 8 TM, SMA 5 TM and TMOA 5 mixtures is based not only on better sound absorption (higher air void content) as it is for porous asphalt PA 8, but also reduction of tyre vibrations (concave and smooth texture).





Figure 2 CPX noise level on both lanes at 40 km/h speed



Figure 3 CPX noise level on both lanes at 50 km/h speed



Figure 4 CPX noise level on both lanes at 80 km/h speed





Figure 5 CPX noise level on both lanes at 100 km/h speed

### 5 Conclusions

Increasing road transport noise problem requires effective and efficient noise abatement and mitigation solutions. Low noise pavements is a very good solution for urban areas or cities, where driving speed is not so high and the dominant vehicle noise source is tyre and road interaction. Effective low noise pavement solutions such as porous asphalt are not very well suitable for colder climate countries due to large number of annual frost-thaw cycles. Therefore, thin layers with optimised surface texture and increased air void content seem to be a compromised solution for both noise reduction and sufficient durability.

Low noise SMA 5 TM, SMA 8 TM and TMOA 5 asphalt mixtures for severe climate conditions were developed in VGTU RRI and were constructed on operating road in Lithuania for further testing under real traffic and climate conditions.

CPX measurements showed that there are quite large differences between 1st and 2nd traffic lanes, in sections constructed of PA 8, SMA 8 TM and SMA 5 TM, differences at higher speeds are even 2.5 dBA. These deviations were mainly caused by the inhomogeneous asphalt layer compaction. This issue revealed the necessity to develop guidelines/requirements for low noise pavement construction.

Since the Test Road of Low Noise Pavements is newly built, the CPX noise level results are preliminary and cannot give accurate expectation of how developed low noise pavements will deteriorate in terms of noise reduction. This will be investigated and analysed after 3 years of periodic CPX, SPB, texture, acoustic absorption and other relevant measurements.

### References

- [1] European Commission: Report from the Commission to the European Parliament and the Council: On the implementation of the Environmental Noise Directive in accordance with Article 11 of Directive 2002/49/EC. COM(2011) 321 final. Brussels, 13 p., 2011.
- [2] Miedema, H., Oudshoorn, C.: Annoyance from transportation noise: relationships with exposure metrics DNL and DENL and their confidence intervals, Environmental Health Perspectives 109 (2001) 4, pp. 409–416. DOI: 10.2307/3454901
- [3] Blickley, J. L., Patricelli, G. L.: Impacts of Anthropogenic Noise on Wildlife: Research Priorities for the Development of Standards and Mitigation, Journal of International Wildlife Law & Policy, 13 (2010) 4, pp. 274-292. DOI: 10.1080/13880292.2010.524564

- [4] Sandberg, U., Ejsmont, J. A.: Tyre/Road Noise Reference Book. Informex, Harg, SE-59040, Kisa, Sweden. 640 p., 2002.
- [5] Rasmussen, R. O., Bernhard, R. J., Sandberg, U., Mun, E. P.: The Little Book of Quieter Pavements. Report No. FHWA-IF-08-004, Federal Highway Administration, Washington DC, 37 p., 2007.
- [6] Descornet, G.: Low-Noise Road Surfaces – European State of the Art, Journal of the Association of Asphalt Paving Technologists, Association of Asphalt Paving Technologists, Vol. 74, pp. 1059-1084, 2005.
- [7] Sandberg, U., Kragh, J., Goubert, L., Bendtsen, H., Bergiers, A., Biligiri, K.P., Karlsson, R., Nielsen, E., Olesen, E., Vansteenkiste, S.: Optimization of Thin Asphalt Layers – State of the Art Review. Research Report. 140 p., 2011.
- [8] Cesbron, J., Anfosso-Lédée, F., Yin, H. P., Duhamel, D., Le Houédec, D.: Influence of Road Texture on Tyre/Road Contact in Static Conditions, Road Materials and Pavement Design, 9 (2008) 4, pp. 689-710, DOI: 10.1080/14680629.2008.9690145
- [9] Huurman, M., Mo, L., Woldekidan, M. F.: Porous Asphalt Ravelling in Cold Weather Conditions, International Journal of Pavement Research and Technology, Chinese Society of Pavement Engineering, Vol. 3 (3), pp. 110-118, 2010.
- [10] Vaitkus, A., Vorobjovas, V., Jagniatinskis, A., Andriejauskas, T., Fiks, B.: Peculiarity of low noise pavement design under Lithuanian conditions, The Baltic Journal of Road and Bridge Engineering 9 (2014) 3, pp. 155–163. DOI: 10.3846/bjrbe.2014.20
- [11] Vaitkus, A., Čygas, D., Vorobjovas, V., Andriejauskas, T.: Traffic/Road Noise Mitigation under Modified Asphalt Pavements, 6<sup>th</sup> Transport Research Arena, Warsaw, Poland, 2016.





## EFFECTIVENESS OF THE STEEL MESH TRACK IN STRENGTHENING CRACKED ASPHALT PAVEMENTS

Piotr Zieliński, Wanda Grzybowska

*Cracow University of Technology, Poland*

### Abstract

In recent years many works have been done in Poland on application of geotextiles and related products to strengthen existing, cracked asphalt pavement structures. Relatively frequently, besides glass, glass-coal and polyester nets, the pavement reinforcing with steel mesh track (to simplify called later as the steel net) is also met, specially on national roads, trafficked with heavy vehicles. The purpose of the paper is to present the selected experiences gained while renewing and strengthening the national roads in the South of Poland. To these works, the steel mesh track of tensile strength 40/50 kN/m was applied. In the paper some design data were given, among others the subgrade analyses, existing layers system, as well as results of the elastic deflections and modulus, measured with FWD apparatus, on the pavement before and after its strengthening. The concept of the reconstruction works comprised the milling of the upper bituminous layer of 4 cm in thickness, laying the profiling course, installing the steel mesh track and bonding it with slurry seal course to the lower surface. As the overlay, two bituminous layers: 4 cm SMA + 8 ÷ 10 cm AC in thickness were placed. After 3 ÷ 5 years of the service, the measuring of pavement deflection bowl with the FWD was conducted and on the base of it, the estimation of its bearing capacity was carried out. Finally, due to the back analyses using the mechanical-empirical calculations, the profit of applying the steel mesh as the reinforcing interlayer in the system of asphalt layers was proved.

*Keywords: Bearing capacity of pavement, Reinforcement with geotextiles, Steel mesh track, FWD deflections, interlayer system*

### 1 Introduction

Problem of strengthening the asphalt layers with using steel grid (mesh track) as well as using the synthetic or glass geogrid interlayer has been recognized from early 90-ties, at the beginning mainly from the practical point of view; lately, the theoretical approach to designing of the pavement structure with geosynthetics has been developed. At first, those interlayers were considered as the stress relieving, i.e. anticracking material, laid over the cracked semi-rigid asphalt pavement, to repair the reflective cracking on the pavement surface. This method regarded as very encouraging, became popular in Poland.

The first comparative tests carried out in the Belgian Road Research Centre in Brussels [1] in early 90-ties on the efficiency of geosynthetics (for nonsynthetic raw material it is also called geotextile) have brought promising results (Figure 1). Those tests revealed, that the steel mesh placed in the asphalt layers submitted to the tensile stress, has got the most advantageous influence on reducing the propagation of crack, reflected from the discontinuity in lower layer. Testing of the above interlayers on real road sections [2] confirmed the best performance in delaying reflective cracking by glass fibre grid and steel mesh track, other types of intermediate layers have proved less effective. Similar results were achieved in Por-

tuguese research [3], where steel mesh with slurry seal had the best performance, and the bitumen impregnated geotextile sections were second best.

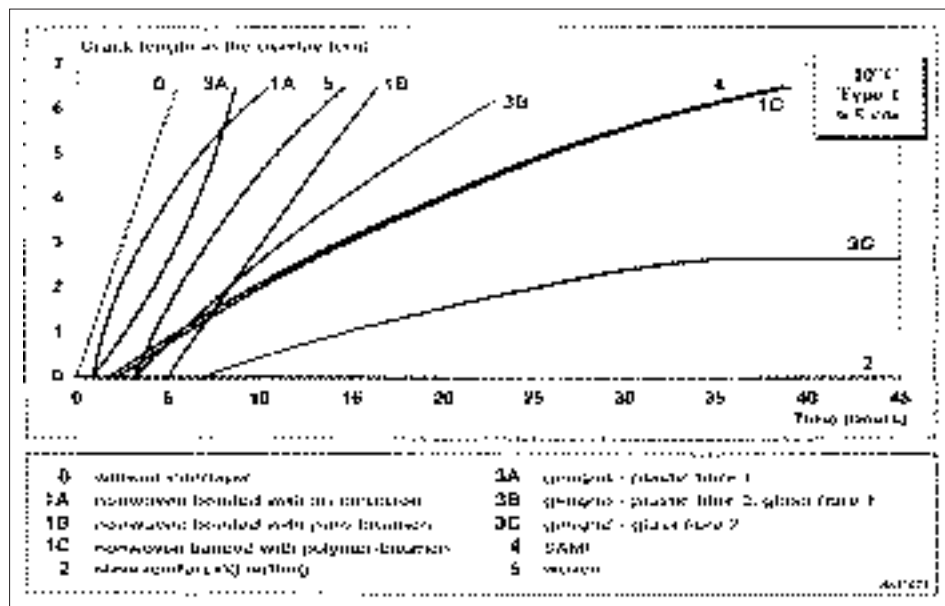


Figure 1 The early comparative tests on the efficiency of the stress relieving interlayer, delaying the reflective cracking propagation in the semirigid asphalt pavements [1]Styles dialogue in Microsoft Word 97-2003.

In all cases de-bonding has to be avoided, otherwise fatigue cracking may appear after finishing these works very quickly. The problem of the conditions required to ensure the effectiveness of geotextile interlayers in the system of asphalt layers was tested in works [4, 5].

In the last years some new research works were taken up, focussed on using the steel grid or glass-carbon grid in asphalt layers as the real reinforcement, diminishing the pavement deflection values, in this way increasing the pavement bearing capacity. Due to which, the fatigue life of the asphalt pavement can be prolonged, or the thickness of the asphalt layers decreased. As the research examples, it can be referred to the research in Belgian Road Research Centre [6], and in Cracow University of Technology [7, 8].

The present paper is devoted to the practical effects (diminishing of deflections) of applying the steel mesh track (the steel net), measured and estimated for the site condition on the asphalt pavement, constructed in the South region of Poland on national roads sections. FWD test results, before and after the reconstruction, have been provided by General Directorate for National Roads and Motorways (GDDKiA), Branch Krakow.

## 2 Selection of testing sections

The road sections selected for the reinforcement and tests did not have proper bearing capacity and were seriously damaged: many longitudinal, transversal (reflective crackings), single and alligator cracks were observed, as well as uneven areas, viscoplastic/structural ruts and patches. The example of the previous pavement condition is done at Figure 2.

All selected sections before reinforcement were submitted to the diagnostic tests of their conditions, according to the Polish System of Pavements Condition Evaluation with the measurement of the deflection bowl and using the Falling Weight Deflection apparatus.



**Figure 2** View of damaged pavement on national road 44

Besides, test holes were made to identify the existing pavements structure and subgrade conditions as well as some laboratory tests on drilled cores were carried out. Those were as follows: the creep test of asphalt samples, the gradation and sand equivalent of aggregates from the base, and soils plasticity test. The list of the analysed road sections together with layers thicknesses measured on pavement cores and layers modulus determined from the back analysis are given in Table 1.

**Table 1** Summary of the analyzed road sections.

Road number	Localization (km)	Asphalt layers	Aggregate subbase	Subgrade
94 – roadway right (Section 1)	285+488 ÷ 286+300	H = 28 cm E = 4111 MPa	H = 17 cm E = 165 MPa	H = infinity E = 92 MPa
	286+300 ÷ 287+450	H = 28 cm E = 3855 MPa	H = 31 cm E = 370 MPa	H = infinity E = 71 MPa
	287+450 ÷ 288+320	H = 26 cm E = 3349 MPa	H = 51 cm E = 159 MPa	H = infinity E = 73 MPa
94 – roadway left (Section 2)	285+488 ÷ 286+650	H = 22 cm E = 3580 MPa	H = 40 cm E = 308 MPa	H = infinity E = 84 MPa
	286+650 ÷ 287+870	H = 22 cm E = 2726 MPa	H = 47 cm E = 249 MPa	H = infinity E = 76 MPa
	287+870 ÷ 288+320	H = 25 cm E = 6594 MPa	H = 47 cm E = 240 MPa	H = infinity E = 132 MPa
94 (Section 3)	305+100 ÷ 307+100	H = 21 cm E = 2661 MPa	H = 29 cm E = 281 MPa	H = infinity E = 57 MPa
7 (Section 4)	632+200 ÷ 634+200	H = 19 cm E = 1903 MPa	H = 66 cm E = 295 MPa	H = infinity E = 66 MPa
44 (Section 5)	101+900 ÷ 102+900	H = 17 cm E = 1500 MPa	H = 40 cm E = 200 MPa	H = infinity E = 50 MPa

### 3 Designed reinforcing structures and there field evaluation

Design activities of the reinforcement included the surface milling to profile the existing structure, laying the steel net and fitting it to the lower layer with slurry seal, next placing the new binding and wearing bituminous layers of total thickness 12 ÷ 14 cm. Details of the designed structures on each road sections are given in Table 2.

**Table 2** Designed structures of pavement reinforcement for the analysed sections of roads.

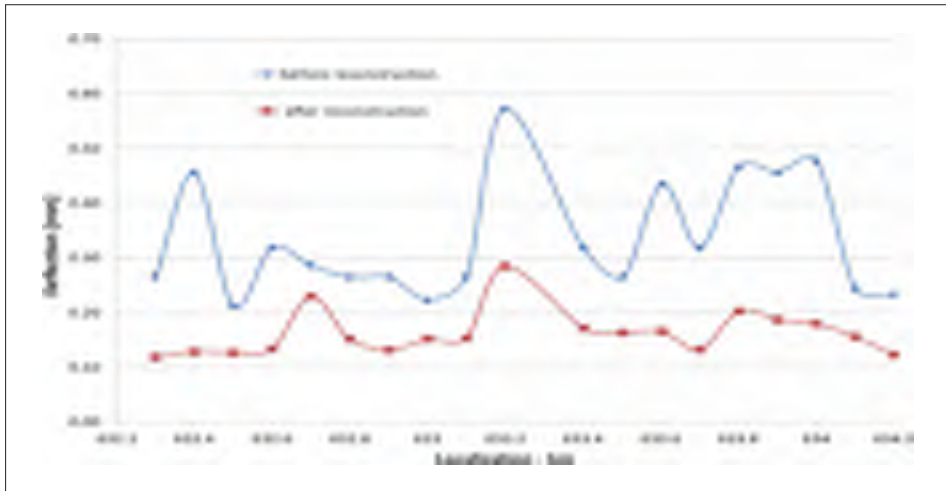
Road number	Localization (km)	Milling depth	Interlayer	New asphalt layers
94 – roadway right (section 1)	285+488 ÷ 288+320	2 ÷ 5 cm	Steel mesh track with 1 cm of slurry seal	8 ÷ 9 cm HM AC + 4 cm SMA
94 – roadway left (section 2)	285+488 ÷ 288+320	3 ÷ 5 cm	Steel mesh track with 1 cm of slurry seal	8 cm HM AC + 4cm SMA
94 (section 3)	305+100 ÷ 307+100	4 cm	Steel mesh track with 1 cm of slurry seal	8 cm HM AC + 4 cm SMA
7 (section 4)	632+200 ÷ 634+200	6 cm	Steel mesh track with 1 cm of slurry seal	10 cm AC + 4 cm SMA
44 (section 5)	101+900 ÷ 102+900	5 cm	Steel mesh track with 1 cm of slurry seal	8 cm HM AC + 4 cm SMA

Designed reinforcing structures were verified with mechanical-empirical method, using the Asphalt Institute USA fatigue criteria [9]. Material parameters were assumed acc. to the Polish recommendations [10], stress and strain states were calculated with the computer program BISAR 3.0, results are given in Table 3. Obtained results have satisfied the requirements for the designed traffic category (that is >14.6 M cycles of standard axle 100 kN during the whole period of pavement exploitation, equal to 20 years).

**Table 3** Results of the fatigue durability of pavement for the analyzed sections of roads.

Road number	Localization [km]	Horizontal strain in asphalt layers	Vertical strain on subgrade	Fatigue durability of pavement [M 100 kN/axle]
94 – roadway right (section 1)	285+488 ÷ 286+300	$52.8 \times 10^{-6}$	$-132 \times 10^{-6}$	52.8
	286+300 ÷ 287+450	$47.8 \times 10^{-6}$	$-124 \times 10^{-6}$	78.8
	287+450 ÷ 288+320	$64.3 \times 10^{-6}$	$-127 \times 10^{-6}$	33.5
94 – roadway left (section 2)	285+488 ÷ 286+650	$59.4 \times 10^{-6}$	$-122 \times 10^{-6}$	46.0
	286+650 ÷ 287+870	$74.3 \times 10^{-6}$	$-131 \times 10^{-6}$	28.1
	287+870 ÷ 288+320	$39.2 \times 10^{-6}$	$-118 \times 10^{-6}$	95.8
94 (section 3)	305+100 ÷ 307+100	$86.3 \times 10^{-6}$	$-218 \times 10^{-6}$	17.6
7 (section 4)	632+200 ÷ 634+200	$79.2 \times 10^{-6}$	$-117 \times 10^{-6}$	18.1
44 (section 5)	101+900 ÷ 102+900	$71.7 \times 10^{-6}$	$-233 \times 10^{-6}$	16.5

During 3-5 years after reinforcement, any damage on the renewed pavements evaluated visually was not seen. In the same time, the tests of elastic deflections with FWD apparatus were carried out on all sections, what allowed to compare the bearing capacity of pavements before and after reinforcement (all values were converted to the equivalent temperature 20°C acc. to [11]). Example of obtained results are presented in Figure 3. To evaluate the significance level of the changes, the statistical tests were conducted with using the method of multiple comparisons and LSD procedures in the Statgraphics program (95% confidence level); the results are presented in Table 4. For all analysed road sections, deflection values after reinforcement are substantially lower than before that treatment, the highest differences were observed for the section of previously the lowest bearing capacity and the thinnest thickness of the structure.



**Figure 3** Comparison of the pavement deflections before and after reinforcement for the road section DK 7 – km 632+200 – 634+200.

**Table 4** Analysis of significance of FWD deflection [ $\mu\text{m}$ ] differences before and after reconstruction, with using the steel net.

Time of measuring	average	standard deviation	coefficient of variation [%]	difference	+/- limits (95%)
DK 94, km 285+488 – 288+320, roadway right (section 1)					
Before reconstruction	188	77	40,6	70	38*
After reconstruction	118	37	31,6		
DK 94, km 285+488 – 288+320, roadway left (section 2)					
Before reconstruction	177	52	29,4	67	38*
After reconstruction	110	29	26,9		
DK 94, km 305+100 – 307+100 (section 3)					
Before reconstruction	306	83	27,0	222	31*
After reconstruction	084	22	25,7		
DK 7, km 632+200 – 634+200 (section 4)					
Before reconstruction	306	98	32,1	144	40*
After reconstruction	163	41	25,5		
DK 44, km 101+900 – 102+900 (section 5)					
Before reconstruction	639	165	25,8	409	45*
After reconstruction	230	65	28,1		

\*denotes a statistically significant difference

The comparison of obtained deflection measurement results with the Polish required values according to the pavement condition evaluation system, i.e. DSN [12], classifies all road tested sections in the class A, what means that the remaining fatigue life is equal to minimum 20 years (the results are given in Figure 4).

To separate and evaluate the influence of the steel net on the rebuilt structure bearing capacity, the next step of analysis was done. It was the comparison of the deflection bowl from FWD test and converted to the static deflection bowl for the structure acc. to [13] with the steel net, with the results for the structure without the steel net, which were calculated using mechanical-empirical calculations in the programme BISAR (the temperature in both



cases was brought to 20°C [11]). Next, for both cases, significance tests for differences in the deflection values were carried out.

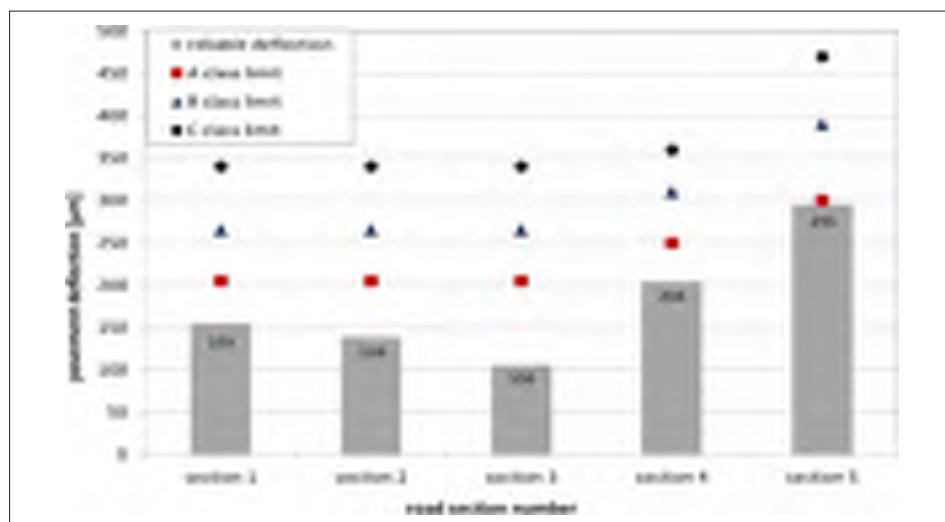


Figure 4 Evaluation of pavement FWD deflection acc. to DSN [12].

Results of the presented analyses given in Table 5 reveal, that the deflection values measured on the sections with the FWD method (steel net reinforced sections), are lower than deflections calculated for reinforcement structures without steel net, what proves the positive effect of the steel net applied to reinforced sections. The most profitable effect was obtained for sections where, before rebuilding, the biggest deflections were obtained, what can explain better mobilization of the steel net in the pavement structure.

Table 5 Significance tests for deflection differences on the sections reinforced with (deflections measured) and without steel net (deflections calculated).

Deflections [µm] (T=20°C)	average	standard deviation	coefficient of variation [%]	difference	+/- limits	
					95%	90%
DK 94, km 285+488 – 288+320, roadway right (section 1)						
Calculated	207	54	26,1			
Measured	199	64	32,2	8	32	27
DK 94, km 285+488 – 288+320, roadway left (section 2)						
Calculated	183	55	30,1			
Measured	173	46	26,9	10	27	23
DK 94, km 305+100 – 307+100 (section 3)						
Calculated	258	65	25,3			
Measured	112	29	25,7	146	22*	19*
DK 7, km 632+200 – 634+200 (section 4)						
Calculated	226	62	27,5			
Measured	196	52	26,7	30	33	28*
DK 44, km 101+900 – 102+900 (section 5)						
Calculated	372	83	22,3			
Measured	304	85	28,1	68	54*	45*

\*denotes a statistically significant difference

## 4 Conclusions

Presented in this paper tests of the road sections and analyses of the results allowed to draw the following conclusions:

- 1) Condition of pavements of all analysed road sections reinforced with the steel net and 12 ÷ 14 bituminous overlay after several years of exploitation is very good. No damages were observed, what confirms the effectiveness of applied solution. Bearing capacity of the tested sections evaluated according to the pavement condition evaluation system, i.e. DSN [12], classifies all road tested sections in the class A, what means that the remaining fatigue life is equal to minimum 20 years.
- 2) Increase of the bearing capacity of reinforced pavements evaluated with the FWD method for all sections is very substantial.
- 3) Deflection values measured on the pavements reinforced with the steel net are lower than deflections calculated with BISAR program for the pavement structure without the steel net. The differences are substantial for 2-3 tested sections, depending on the assumed significance level 95% or 90 %.
- 4) The best effectiveness of the steel net applied is observed for the sections where the bearing capacity before rebuilding was the lowest, and where the steel net is placed in the tension zone.
- 5) Analysed road sections require longer periods of time to observe their condition, and in this way to better evaluate the steel net efficiency in reducing the possible reflective crackings as well as in prolonging the fatigue life.

## References

- [1] Vanelstraete, A., Francken, L.: Laboratory testing and numerical modelling of overlay systems on cement concrete slabs, Proceedings of the 3rd RILEM Conference on Reflective Cracking in Pavements, Maastricht, pp. 170-181, 1996.
- [2] Vervaecke, F., Maeck, J., Vanelstraete, A.: On site validation and long term performance of anti-cracking interfaces, Proceedings of the 6th RILEM International conference on cracking in pavements, Chicago, pp. 761-768, 2008.
- [3] Antunes, M.I., Fontul, S., Pinelo, A.M.: Anti-reflective cracking solution for asphalt overlays: 8 years performance monitoring, Proceedings of the 6th RILEM International conference on cracking in pavements, Chicago, pp. 791-798, 2008.
- [4] Grzybowska, W., Zieliński, P., Górszczyk, J.: Influence of material parameters on durability of asphalt mixtures in different loading conditions, Research Project financed by Polish Research Committee (No 8.T07 E. 043.21), Cracow, 2003 (Edition in Polish).
- [5] Zieliński, P.: Chosen problems of asphalt pavement durability with the geotextile interlayer, PhD thesis, Cracow University of Technology, 2004, (Edition in Polish).
- [6] Vanelstraete, A., Leonard, D.: The Design of concrete pavements reinforced with glass fibre grid – Comparison between the anticracking systems Bitufor and Trasys, Belgian Road Research Centre, Brussels, June 1999.
- [7] Grzybowska, W., Górszczyk, J., Zieliński, P.: Modeling of the asphalt pavement structure behavior in different conditions of interlayer bonding, using geosynthetic reinforcement, Research Project financed by Polish Ministry of Education and Computerization (No 4T07E 01328), 2007 (Edition in Polish).
- [8] Górszczyk, J.: The influence of reinforcing geosynthetic interlayer on the fatigue durability of asphalt road pavement, PhD thesis, Cracow University of Technology, 2010 (Edition in Polish).
- [9] Research and development of the Asphalt Institute's: Thickness Design Manual (MS-1). Ninth edition, The Asphalt Institute, Research Report No. 82-2, RR-82-2, August 1982

- [10] Gdansk University of Technology: Catalogue for flexible and semirigid typical pavement structures, 2012 (Edition in Polish).
- [11] IBDiM: Catalogue for designing of flexible and semirigid pavement structures rebuilding and renovation, Warsaw, 2013 (Edition in Polish).
- [12] GDDKiA: The pavement condition evaluation system – usage guidelines, Warsaw, 2015 (Edition in Polish).
- [13] Krawczyk, B.: Identification of parameters for road pavement models derived from dynamic impulse test, PhD thesis, Wrocław University of Technology, 2012, (Edition in Polish).



## POROSITY EFFECT ON PHYSICAL AND MECHANICAL PROPERTIES OF PERVIOUS CONCRETE PAVEMENT

Miloš Šešlija, Vlastimir Radonjanin, Nebojša Radović, Đorđe Ladinović

*Faculty of Technical Sciences, University of Novi Sad, Serbia*

### Abstract

The paper presents the results of previous researches of different mixtures of pervious concrete pavements in the world, as well as the advantages and disadvantages of the structural formation on the mechanical properties of porous concrete. The porosity of pervious concrete ranges from 15% to 35%. The most important properties of pervious concrete pavement were analyzed: compressive strength, flexural strength, splitting tensile strength, frost resistance and abrasion resistance. Different types of aggregates (natural, recycled), different fractions and granulometric composition of aggregates, different amounts of fine aggregate, different types and amounts of additives in pervious concrete and various water-cement ratio, were used in the analyzed studies. According to obtained results, the relationship between the most important properties of pervious concrete and its porosity was established. It was concluded that increasing of the porosity directly affects to decreasing of the concrete compressive strength and frost resistance, while abrasion resistance is increasing.

*Keywords: pervious concrete, porosity, physical and mechanical properties*

### 1 Introduction

The pervious concrete pavement is a special form of concrete pavement, which is mostly used in the United States, a little less in Europe, while in Serbia there are still no application and research of this type of concrete. It is the concrete which has a distinct porosity and therefore leaks water, reduces noise, reduces the need for building of system for water drainage from the roadway, facilitates water purification, etc. With the aspects of preserving the natural environment the pervious concrete is quite beneficial compared to other types of road surfaces. The first application of the pervious concrete occurs in 1852 for the building of two houses in the UK, this concrete is composed of coarse gravel and cement [1, 2]. Then appears in the construction of houses in Scotland 1874-5 and the other buildings till the period of 1890 [3]. In the Netherlands, after World War I, it was first used and made of crushed brick as aggregate with the addition of cement [4]. The pervious concrete is a mixture of cement, water and one fraction aggregates which does not contain the fine particles of aggregates. Contains a large amount of voids, which leads to a reduction of strength and weight [5, 6]. Pervious concrete has different names in English, for example no-fines concrete, pervious concrete, porous concrete and zero-fines concrete. These are the names can be found in worldwide literature and indicate already mentioned concrete [7]. The void content ranges from 15-35%, if its preparation is done in America, or 15-25% of void content if the pervious concrete is made in Europe [8]. The recommended aggregate sizes for this concrete are taken in a range of 9.5 to 19.5 mm, therefore completely omits small aggregate or added in the lower percentage. Due to such structure, the pervious concrete made with no additives has a relatively low compressive strength from 2.8 MPa do 28 MPa. In order to avoid the filling of pores with cement

paste, its amount is regulated by a lower water-cement factor, which is usually in the range from 0.26 to 0.50 [9].

The paper presents the different composition of the mixtures, the results of previous researches in the world, the advantages and disadvantages of the structural formation on the physical and mechanical properties of porous concrete.

## 2 Review of the mix composition and properties of pervious concrete

Analyzed articles in this area of the production and use of pervious concrete and related laboratory tests differ in the composition of the mixture and laboratory tests were carried out according to the research objectives of individual works. Detailed analysis of published papers dealing with this topic, showed the possibility of using pervious concrete for the construction of the parking areas and pavement on low trafficked streets, the bicycle and pedestrian paths, tennis courts and the floors in greenhouses and breeding animal farms. Since the aggregate takes between 70-80% of the total concrete amount, aggregate strength greatly affects on the final strength of the concrete. Type of aggregate, aggregate fraction, as well as additives and its quantity are shown in Table 1, with indicated authors that have carried out studies of the pervious concrete.

**Table 1** Composition mixture of pervious concrete

Ref.	Aggregation	Aggregate fraction [mm]	The chemical and /or mineral admixtures	Water-cement ratio
[10]	Granite	4.75-9.5	Silica fume, superplasticizer, fly ash, polymer	0.28-0.34
[11]	Limestone	4.75-12.5	Retarders, admixtures	0.29
	Sand	0-4		
[12]	Gravel	3-5; 5-10; 10-20, 15-30	Silica fume, superplasticizer, fly ash, polymer	0.20-0.35
	Sand	0-2.5		
[13]	Gravel	2.36-4.75, 4.75-9.5, 9.5-12.5	Synthetic rubber products, silica fume, air entraining admixtures, superplasticizer	0.22-0.27
	Limestone	4.75-9.5		
	Lightweight Aggregates	2.36-4.75, 4.75-9.5		
	Sand	0-1		
[14]	Gravel	1.18-9.5	Latex rubber, fibre, superplasticizer, air entraining admixtures, retarders	0.26-0.36
	Limestone	1.18-9.5, 2.36-9.5		
[15]	Gravel	10-12.5		0.27
	Recycled rubber products	0-1, 1-4, 4-8		
[16]	Gravel	10-12.5		0.27
	Recycled rubber products	0-1, 1-4, 4-8		

### 2.1 Compressive strength of pervious concrete

Based on all inspected papers [10-15] it can be noticed that compressive strength at 28 days ranges from 6.54 MPa to 61.2 MPa. Displayed compressive strength values are given based on different aggregation type, aggregate fraction, chemical/mineral admixtures and water-cement ratio (Table 1). It must be underlined that compressive strength of pervious concrete mainly depends on ratio between coarse aggregate and fine aggregate and water-cement ratio. Using coarse aggregate with fine aggregate, along with solid compacting, adequate water-cement ratio and admixtures, it can be accomplished significantly larger compressive strength values [10, 12] in comparison with expected values from papers. In the Figure 1 is

summary of results from some of the considered papers and the dependence between compressive strength and void content of 28 day old concrete has been given. It is noticeable that there is a large dispersion of results and that is not possible to determine compressive strength as a function of void content. With decrease in void content there is increase in dispersion of results (so as vice versa).

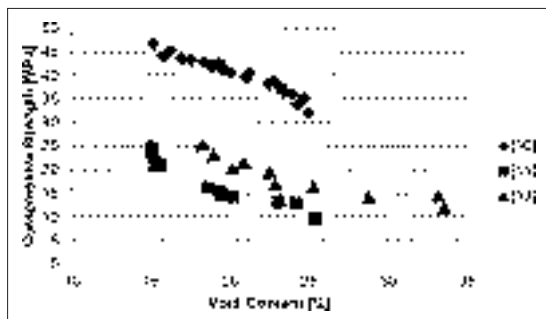


Figure 1 Plot of compressive strength as a function of void content

## 2.2 Flexural strength

The sharp shape and rough surface of crushed aggregate are favorable for an aggregate-cement paste bond, which affect the increase in flexural strength. Tested 28-day old samples have flexural strength in values between 0.4 – 8.5 MPa [10, 12, 16]. It has been used various aggregate fractions and admixtures for the preparation of mixtures, in a variety of test conditions (Table 1). With an increase in amount of rubber material [16] there is a decrease in value of flexural strength, and with an optimal amount of fine aggregate (sand) [12] there is significant increase in flexural strength. In considered papers it can be seen that the increasing of porosity decreases the flexural strength (and vice versa).

## 2.3 Splitting tensile strength

This type of test procedure has appeared much later than traditional tests for bending and nowadays is regarded as quite reliable measure for determining tensile strength of concrete. According to the papers [11, 13, 14], splitting tensile strength at 28 days ranges from 1 MPa to 4 MPa. The characteristic values are taken for the different aggregate fractions, with or without air entraining admixtures, and with or without recycled aggregate.

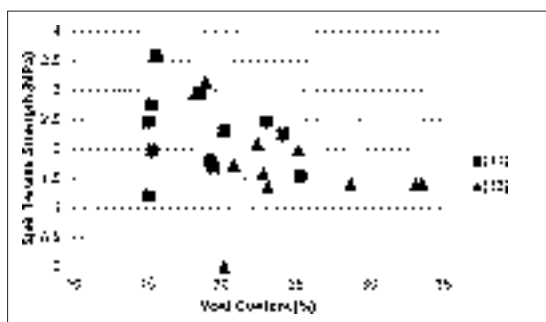


Figure 2 Plot of splitting tensile strength as a function of void content

Figure 2 shows the dependence of splitting tensile strength on the amount of pores for 28-day old samples. Considering all obtained results it can be seen that there is a large dispersion of the results for the same splitting tensile strength and porosity, so that it cannot be determined a particular correlation between previously mentioned parameters. It is impossible because of the participation of various types of aggregates, chemical and/or mineral admixtures, as well as various types of binders.

## 2.4 Abrasion resistance

Abrasion, as a way of mechanical process of wearing concrete away, is very important in assessing durability of concrete. This phenomenon usually appears in high-traffic areas, sidewalks and parking lots. Concrete is more resistant to abrasion with larger compressive strength, which means that it should be used crushed stone aggregate with less participation of fine aggregates, high-early strength cement and lower water-cement ratio. Therefore, superplasticizers and plasticizers are used to reduce the required amount of water, since in any case should not be allowed to come to the separation of the cement paste to the surface. Abrasion resistance has been analysed in papers [11] and [16], but the different aggregate types, fractions and number of cycles have been used. Figure 3 presents summarized results from the analyzed papers and shows the loss of weight as a percentage. Usage of reduced amounts of fine aggregate and adding admixtures [11] results with a smaller weight loss in comparison to samples which have a certain amount of fine aggregate fraction. Nevertheless, using recycled rubber [16] instead of natural aggregates also reduces the mass loss of samples.

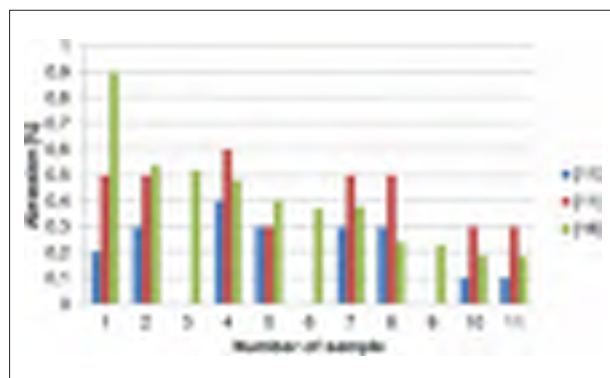


Figure 3 Abrasion test

## 2.5 Frost resistance

The main reasons for concrete destruction on lower temperatures are internal stresses that occur during freezing water in the pores of concrete. Volume of liquid water at room temperature will increase in volume by 9% after freezing, which generates internal stresses. However, in order to prevent the destruction of concrete, it is necessary to use sufficiently low water-cement ratio as well as various admixtures, especially air entraining admixtures. According to paper [11, 13, 14, 16] frost resistance is tested with about 300 freeze-thaw cycles. Figure 4 presents a plot of number of cycles as a function of mass loss. It is shown that frost resistance can be improved by using sand, recycled rubber as well as air entraining admixtures so that the number of freeze-thaw cycles can reach up to 300. According to mentioned Studies, the best frost-resistant mixtures consist of natural aggregates along with certain amount of sand and chemical admixtures (Table 1).

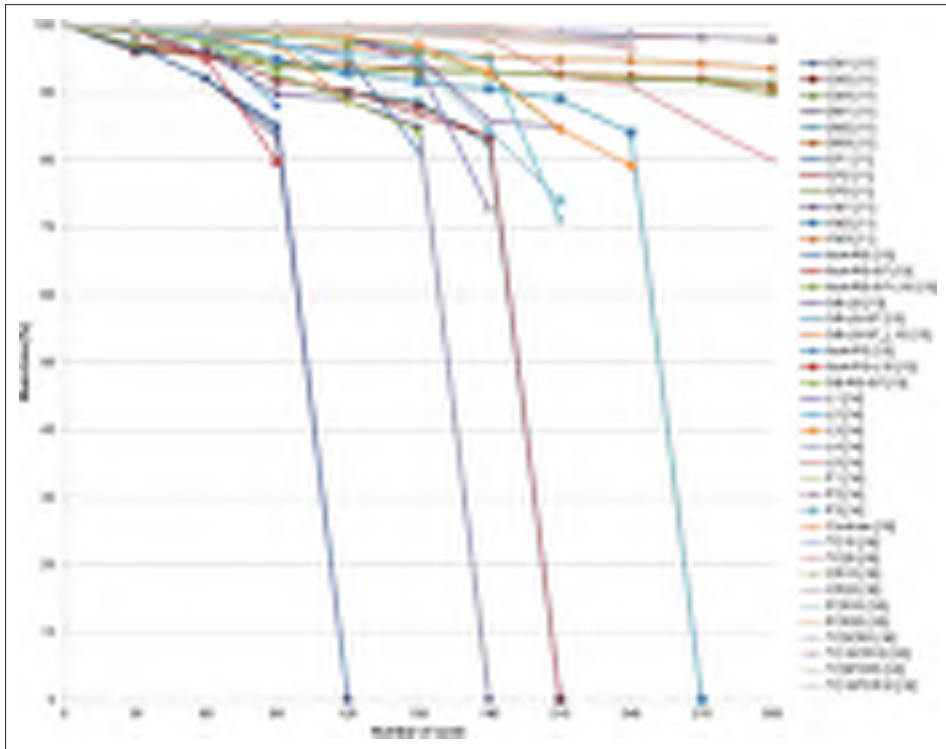


Figure 4 Frost resistance of pervious concrete at 28 days

## 2.6 Porosity

Pore size is one of the main factors which impacts on pervious concretes' properties. It is recommended large pore volume because they can prevent themselves from clogging [17]. Pore size increases with larger participation of coarse aggregate in comparison to fine aggregate. This is explained by the fact that between the large grains remain empty spaces [18]. Namely, porosity has an effect on flexural strength, compressive strength, splitting tensile strength and frost resistance. It has been shown that at a lower porosity, regardless of the type of aggregate that was used, compressive strength is higher. In case of using recycled aggregation there is about 60% lower compressive strength in comparison to mixtures with natural aggregation (with the same level of porosity). Type of aggregate (natural or recycled) has an effect on coefficient of permeability and porosity for pervious concrete mixtures.

## 3 Conclusions

The analyzed results can be summarized as follows:

- with the same level of porosity there have been different values of flexural strength, compressive strength and splitting tensile strength due to different water-cement ratio. With an increase in porosity there is a decrease in strength of pervious concrete.
- with larger participation of fine aggregate and higher water-cement ratio, the frost resistance is higher but the abrasion resistance is lower.
- porosity of pervious concrete is strongly affected by the type and fraction of aggregation, with taking into account that the minimal porosity for pervious concrete is 15%.



Properties of pervious concrete are strongly affected by the porosity along with type of aggregate, participation of fine aggregates, shape of aggregate grains, type of used admixtures, water-cement ratio etc. All the mentioned factors are in certain correlation and they need to be chosen in such a way that the higher values of flexural strength, compressive strength, splitting tensile strength, abrasion and frost resistance are achieved. If it is used with improved properties, pervious concrete can be used in heavy traffic load as well.

## 4 References

- [1] Ghafoori, N., Dutta, S.: "Laboratory Investigation of Compacted No-Fines Concrete for Paving Materials", *Journal of Materials in Civil Engineering*, 7 (1995) 3., pp. 183-191.
- [2] Patil, V.R., Gupta, A.K., Desai, D.B.: "Use of Pervious Concrete in Construction of Pavement for Improving their Performance", *Journal of Mechanical and Civil Engineering* (2010), pp. 54-56.
- [3] Urquhart, D.: "Historic Concrete in Scotland Part 1: History and Development", *Historic Scotland*, Edinburgh, March, 2013.
- [4] Moss, J.K.: "No-fines building gives energy-conserving homes, a system that saves both energy and cement", *International Construction* Sutton, Surrey, England, 1979.
- [5] Šešlija, M., Radović, N., Trivunić, M., Bibić, D., Peško, I.: "Analysis of pervious concrete pavement", *International Conference on Contemporary Achievements in Civil Engineering 2015*, Faculty of Civil Engineering Subotica, Subotica, Serbia, pp. 429-434, 2015
- [6] Šešlija, M., Radonjanin, V., Milović, T., Šupić, S., Vukoslavčević, S.: "Application of pervious concrete in road engineering", *16<sup>th</sup> International Conference on Macedonian Association of Structural Engineers*, Struga, Ohrid Lake, Macedonia, pp. XX-XX, 2015.
- [7] Harber, P.J.: "Applicability of No-Fines Concrete as a Road Pavement", *Bachelor of Engineering (Civil)*, University of Southern Queensland, Australia, 2005.
- [8] Kevern, J.T.: "Advancements in pervious concrete technology", *Iowa State University*, United States, 2008.
- [9] Mrakovčić, S., Čeh, N., Jugovac, V.: "Effect of aggregate grading on pervious concrete properties", *GRAĐEVINAR* 66 (2014) 2, pp. 107-113, doi: 10.14256/JCE.977.2013
- [10] Chen, Y., Wang, K., Wang, X., Zhou, W.: *Strength, fracture and fatigue of pervious concrete*, *Construction and Building Materials* 42 (2013), pp. 97-104.
- [11] Amde, A.M., Rogge, S.: *Development of High Quality Pervious Concrete Specifications for Maryland Conditions*, Department of Civil and Environmental Engineering, University of Maryland, College Park, February 2013.
- [12] Yang, J., Jiang, G.: *Experimental study on properties of pervious concrete pavement materials*, *Cement and Concrete Research* 33 (2003), pp. 381-386.
- [13] Schaefer, V.R., Wang, K., Suleiman, M.T., Kevern, J.T.: *Mix Design Development for Pervious Concrete In Cold Weather Climates*, Center for Transportation Research and Education, Iowa State University, Ames, February 2006.
- [14] Shu, X., Huang, B., Wu, H., Dong, Q., Burdette, E.G.: *Performance comparison of laboratory and field produced pervious concrete mixtures*, *Construction and Building Materials* 25 (2011), pp. 3187-3192.
- [15] Gesoglu, M., Guneyis, E., Khoshnaw, G., Ipek, S.: *Investigating properties of pervious concretes containing waste tire rubbers*, *Construction and Building Materials* 63 (2014), pp. 206-213.
- [16] Gesoglu, M., Guneyis, E., Khoshnaw, G., Ipek, S.: *Abrasion and freezing-thawing resistance of pervious concretes containing waste rubbers*, *Construction and Building Materials* 73 (2014), pp. 19-24.
- [17] Blažok, D.: *Propusni beton za kolnike*, *Tehnički glasnik* (2010) 4, pp. 15-18.
- [18] Stojanović, M., Šešlija, M., Malešev, M., Radonjanin, V.: *Svojstva propusnog betona i mogućnost njihove primene u savremenoj putogradnji*, *Prvi srpski kongres o putevima*, Beograd, pp. 829-838, 2014.



## ANALYSIS OF SOLUTIONS FOR SUPERELEVATION DESIGN FROM THE STANDPOINT OF EFFICIENT DRAINAGE

Martina Zagvozda<sup>1</sup>, Željko Korlaet<sup>2</sup>

<sup>1</sup> University of J.J. Strossmayer in Osijek, Faculty of Civil Engineering Osijek, Croatia

<sup>2</sup> University of Zagreb, Faculty of Civil Engineering, Croatia

### Abstract

The determination of pavement cross slope is integral part of geometric design of roads. It is performed due to reasons of driving dynamics i.e. to ensure lateral stability of vehicle in a curve and also to assure optimal drainage of pavement. Empirical knowledge, incorporated in guidelines for road design in many countries, indicate that the minimum value of cross slope to ensure sufficient drainage is 2.5%, which is also common value on the tangent parts of the road. The problem occurs on parts of the route between the opposite curves in which, due to the need for change in cross slope direction, the cross slope ranges from 0-2.5%. A particular problem occurs on parts of the route with (too) small longitudinal gradient, which does not ensure efficient drainage in the longitudinal direction.

The subject of this paper is analysis of options for superelevation design in a number of countries (CRO, D, A, CH, UK, USA, AUS), and a critical comparison of available solutions, considering the criteria of efficiency or optimization of pavement drainage.

*Keywords: superelevation, geometric design, sufficient drainage*

### 1 Introduction

Road design should be carried out with the goal of safe and comfortable ride on a given road. Pavement cross slope is an element of a geometric design, performed for lateral stability of vehicle in a curve and to assure unobstructed drainage of pavement. Minimum cross slope of 2.5%, conditioned by optimal pavement drainage, is also the most frequently used value in the tangent (varies according to guidelines from 2-3%). Rotation of one-sided cross slope from one direction to another inevitably passes through the zone with cross falls smaller than 2.5% (0%). In combination with very small and insufficient longitudinal gradient, it leads to accumulation of water film on the road surface which can have significant consequences for traffic safety: reducing the adhesion between the road surface and tires, loss of vehicle stability, water splashes and reduced visibility, and at high speeds occurrence of hydroplaning.

### 2 Possibilities for superelevation design

Guidelines of certain countries contain mostly the same or similar standardized superelevation designs, which differ according to the axis of roadway rotation, location of superelevation transition and the type of cross section that is applied in tangent (one sided, crowned). Along prescribed solutions for superelevation design, some guidelines identify drainage problems of superelevation development in reverse curves so they prescribe restriction of longitudinal gradient, the intensification of rate of rotation in the zone with no slopes (plateaus) and, in different versions, superelevation design with diagonal crown.

## 2.1 Croatia [1]

In Croatian guidelines superelevation development should be carried out within the transition curve, rotating roadway around its centerline or its lower edge in roads with only one roadway, or around the centerline or the edge of the median in roads with two roadways. The layout of superelevation development is defined by superelevation transition gradient, and its maximum values are defined in relation to the design speed and the width of the roadway. The minimum rates of gradient are limited due to sufficient drainage of pavement in areas of change of cross slope orientation, which includes 0% cross slope. In the case where the rate of rotation is less than the minimum, it should be intensified by using minimal value from the inflection point until achieving cross-slope of 2.5%, followed by rate that is less than minimal because the drainage is provided by achieved cross slope (Fig. 1). In these areas it is recommended that longitudinal gradient is 0.3% (preferably 0.5%) higher than the rotation rate in order to improve the drainage conditions.

## 2.2 Germany [2,3]

According to German guidelines superelevation development should also be carried out on the length of transition curve, and centerline of road or of a particular roadway is preferred for the axis of pavement rotation, but if necessary internal or external edge of the road can be used (Fig. 1). Limits of superelevation transition gradient depend on the road category and pavement widths. When the gradient is less than the minimal, in areas where cross slope orientation changes, the minimum value should be adopted in the section between -2.5% and + 2.5%. The longitudinal gradient of pavement edges and road centerline should be aligned to avoid adverse slopes and their differences should be a minimum of 0.2%. It is therefore recommended that minimum longitudinal gradient of road centerline is greater than or equal to 1.0% (exceptionally 0.7%), while the longitudinal gradient of the pavement edge should be greater than or equal to 0.5% (exceptionally 0.2%). In the absence of the required longitudinal gradient, 0% cross fall can be relocated away from the inflection point of reverse curves.

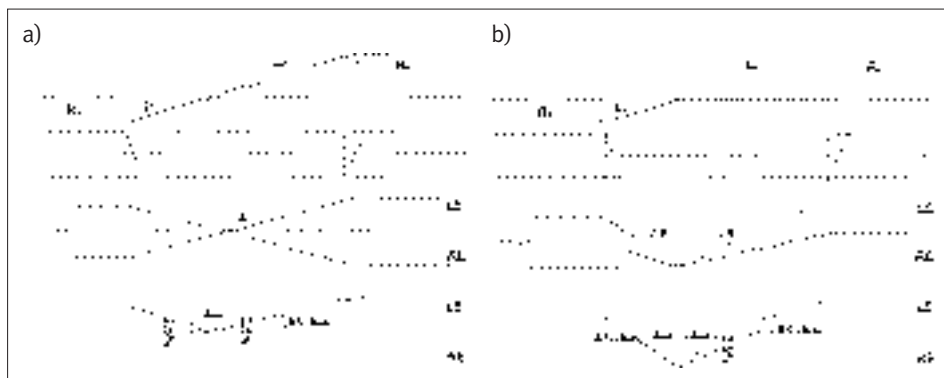
## 2.3 Austria [4]

In Austrian guidelines superelevation development is performed on the length of transition curves, including short tangents in between, but guidelines show only pavement rotation along roadway centerline (Fig. 1). Limit values of superelevation transition gradient are defined according to the width between rotation axis and roadway edge. Where the superelevation transition gradient is less than the minimum and there is no longitudinal gradient, a minimum value should be used until cross slope of 2.5% is reached while the rest of superelevation transition has gradients less than minimal, or diagonal crown can be used. Diagonal crown is recommended for insufficient longitudinal gradients because cross fall of entire section is 2.5% (Fig. 2a).

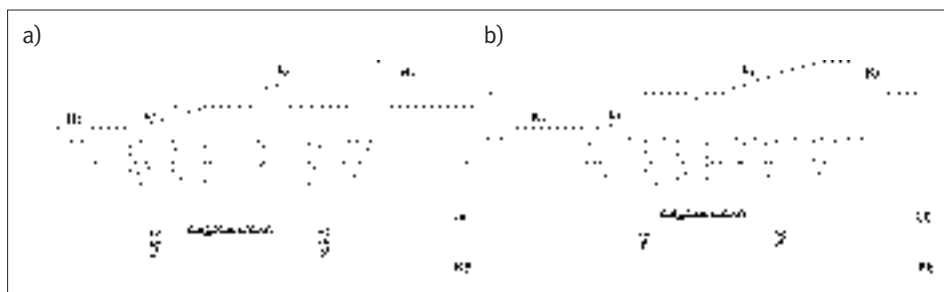
## 2.4 Switzerland [5]

Swiss guidelines emphasize the need for careful superelevation design because of the possible consequences on the safety, related to the lateral run-off on pavements, the optical guidance and sudden changes in lateral acceleration that are not compensated by transverse slope. Superelevation development is performed on the length of the transition curve, while selection of the rotation axis depends on cross slope, pavement rotation rate and position of road in road network. When the superelevation transition gradient is less than the minimum allowed, it is necessary to carry out intensified superelevation development or diagonal crown. Diagonal crown is necessary at high speed roads where the diagonal slope is less than

0.5%. It is carried out until 3% cross fall (Fig. 2b) and its length depends on the speed and width of the roadway.



**Figure 1** Reverse curves superlevation design: a) around pavement centerline (CRO, D, A) and b) around pavement edge (CRO, D)



**Figure 2** Diagonal crown according to a) A i b) CH

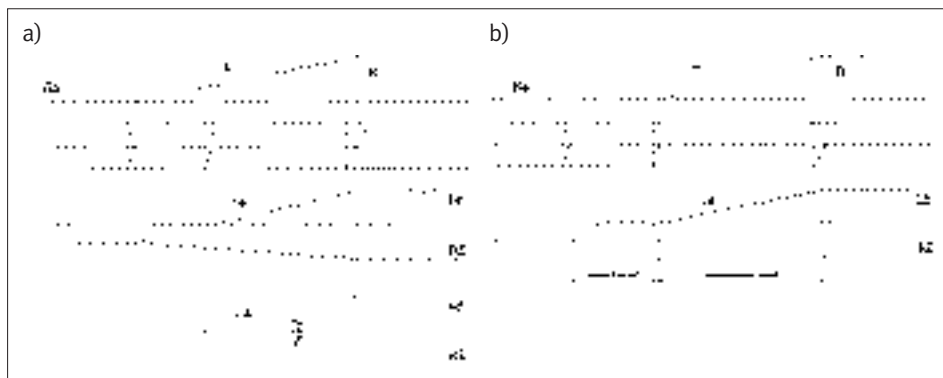
## 2.5 United Kingdom [6]

Superelevation development should be performed on the length of the transition curve, or when missing, partially on the tangent (1/2 to 2/3 of development length) and the rest on the arc. Guidelines do not define necessary type of superlevation design nor do they define around which axis it should be carried out. However, some conditions related to the drainage and driving dynamics are listed: superlevation development may not be performed so gradually to create plateaus or so sharply to cause driver discomfort from the kink in edges of the roadway. Therefore, the difference of gradient of rotation axis and the edge of the pavement should not be greater than 1% (0.5% on motorways) and all changes in edge profile should be smoothed. In areas of superlevation transition longitudinal gradient should not be less than 0.5%. In case of problems with drainage, solution should be found in changes to horizontal alignment, increased rate of pavement rotation, or application of the diagonal crown.

## 2.6 United States of America [7]

In the United States commonly applied is crowned cross section, therefore superlevation design consists of two parts: tangent runout and superlevation runoff (Fig. 3). Tangent runout is rotation of part of the roadway (single lane) with cross slope of opposite direction than those in curve, until 0% is reached. Superlevation runoff represents rotation of part of the

roadway with 0% cross slope to achieve a one-sided slope for the whole width of the roadway and further simultaneous rotation to the necessary superelevation in curve. Application of transition curve is not obligatory, and if it is not applied, superelevation development takes place partly in the tangent (60-90% of development length) and the rest in the curve. Superelevation development can be made around centerline, inner or outer edge of the roadway with crowned cross section, while in the application of one-sided cross fall the rotation axis should be outer edge of the roadway. In order to avoid problems with drainage in the area of superelevation development, recommendation is that longitudinal gradient of at least 0.5% is provided for centerline and 0.2% for pavement edge.



**Figure 3** Superelevation design from crowned cross section on tangent to one-sided cross section on curve  
a) D i CH te b) USA

## 2.7 Australia [8]

Since in Australia mostly applied on tangent is crowned cross section, superelevation design, as in the United States, consists of tangent runoff and superelevation runoff. Between two curves a minimal length of tangent and crowned cross section should be ensured. For better drainage it is recommended to rotate pavement around its inner edge and longitudinal gradient of the pavement edge should be at least 0.2-0.3%. Areas near inflection of reverse curves must not coincide with 0% longitudinal gradient, and possible occurrence of the plateau should be checked by contour plan.

## 3 Comparison of characteristic examples of superelevation designs

Comparison was carried out for five characteristic superelevation designs, which effectively “cover” or represent all of the examples mentioned in Chapter 2 (Fig. 4).

Selected examples were analyzed for the road category 3-d [1], same design conditions (reverse curves without tangent section, radii  $R_1 = R_2 = 250\text{m}$  with transition curves  $L_1 = L_2 = 100\text{m}$  and longitudinal gradient of 0.1%) and cross section elements (roadway width 7.10 m, superelevation in curve of 7%). Obtained contour plans with equidistance of 20mm for the area around the inflection point are shown in Fig. 5.

On models of considered superelevation designs it is possible to observe the plateau areas, or areas with very small transverse slopes which retain water. By analyzing modelled superelevation designs it is evident that at conventional superelevation design around centerline (example 1) region with small cross slope extends to largest area around the inflection point, and similar situation happens with superelevation design around pavement edge (example 3). Superelevation design around axis intensified by  $\Delta s_{\min}$  (example 2) is more suitable so-

lution, because the area of small cross slopes is reduced, but is still present. In superelevation design with crowned cross section on tangents (Example 4) plateaus are shifted away from the inflection point and limited to a particular lane, because lanes are rotated as two independent surfaces. From the standpoint of drainage, a favourable feature of this solution is narrower surface (one lane) and the shorter runoff length, because the second lane has sufficient cross slope. With diagonal crown (example 5), the formation of the plateaus does not happen and cross slope is always at least minimal 2.5%. Also, it is obvious that in areas where plateaus would be created with conventional superelevation design, runoff lengths achieved here are approximate to those on tangents with one-sided cross slope.

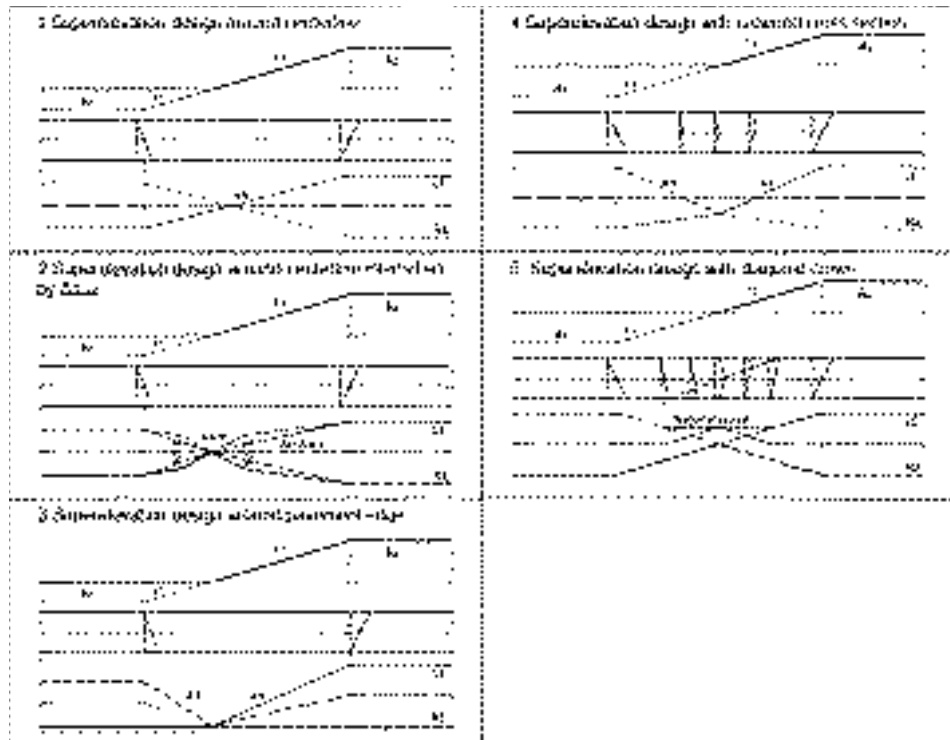


Figure 4 Characteristic superelevation design schemes

Although diagonal crown proved to be the best from drainage standpoint, it contains some unresolved issues and problems related to driving dynamics. Crossing the diagonal crown causes the impact of vehicle on ridge and results in vertical and radial acceleration, which can cause discomfort and adversely affect safety. For this reason it is necessary to smooth the ridge with a certain radius (such as prescribed by guidelines [4]). In addition, the right pair of wheels drive on the oppositely oriented cross slopes in relation to the center of curvature, which further aggravates the widely accepted rules of lateral stability of vehicle in a curve, or the interdependence of the value of cross fall, radius and radial friction coefficient. This problem is also present in designs with crowned cross sections (Example 4), although it is less pronounced since adverse slopes occur on areas closer to the inflection point, where the curvature of transition curve is relatively small. Design with diagonal crown is also unfavourable from construction point of view, because the exact designed geometry is very complicated to perform, and even harder to maintain (in reconstructions).

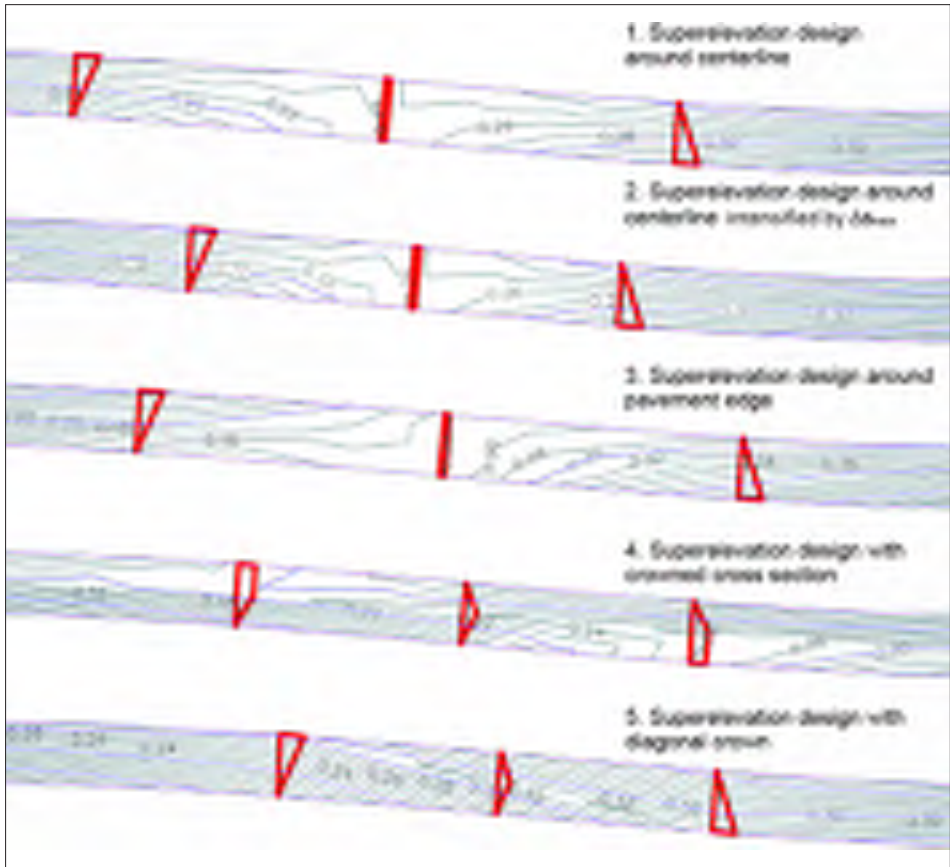


Figure 5 Contour plans of modelled superelevation designs

## 4 Conclusion

Based on the analysis carried out in Chapter 3, it is clear that the designer is not in an enviable position when searching for the optimal solution. Initially, he is obliged to respect the recommendation of avoiding concurrence of inflection points in horizontal alignment with vertical alignment without longitudinal gradient (flat vertical alignment, the apex of the convex and especially concave vertical curves). Next limitation is respecting the minimum longitudinal gradient, and here a problem is produced because the recommendations in this regard differ, and also considering the fact that the increase of longitudinal gradient accelerates the runoff speed, but increases runoff length and final thickness of water film. The next decision relates to shortening the area with unfavorable cross slopes smaller than 2.5%, applying the  $\Delta s_{\min}$ , which ultimately favors a solution in example 2 ahead of solutions in examples 1 and 3. The decision to apply superelevation design with crowned cross section (example 4) or diagonal crown (example 5), should be well thought over, bearing in mind the difficulties of implementation and maintenance of these solutions.

Limit of the paper volume is the reason that this does not show solutions that actually (transverse slotted drains [9], etc.) or at least partially (pavement grooves [10], grinding [11], etc.) enhance the efficiency of the pavement drainage on superelevation development areas with insufficient cross slopes. It should be noted that the implementation of such solutions is

generally expensive, and maintenance costs of some do not justify their widespread application. Since the phenomenon of aquaplaning is directly related to the driving speed, for the necessary driving safety on the roads remaining is the measure of limiting speed in adverse weather conditions, whether it is conducted by authorized institution and (or) each driver individually.

## References

- [1] Pravilnik o osnovnim uvjetima kojima javne ceste izvan naselja i njihovi elementi moraju udovoljavati sa stajališta sigurnosti prometa, NN 110/01 (in Croatian)
- [2] Forschungsgesellschaft für Straßen- und Verkehrswesen: Richtlinien für die Anlage von Autobahnen RAA, 2008 (in German)
- [3] Forschungsgesellschaft für Straßen- und Verkehrswesen: Richtlinien für die Anlage von Landstraßen RAL, 2012 (in German)
- [4] Österreichische Forschungsgesellschaft Strasse-Schiene-Verkehr: RVS 03.03.23 Linienführung und Trassierung, 2014 (in German)
- [5] Schweizerischer Verband der Strassen- und Verkehrsfachleute: Schweizer Norm SN640 120
- [6] The Highways Agency: Design manual for roads and bridges, Volume 6 Road geometry, Section 1 Links, TD 9/93, 2002
- [7] AASHTO: Geometric Design of Highways and Streets, 2004
- [8] Main Roads West Australia: Supplement to Austroads Guide to Road Design – Part 3, 2015
- [9] Ressel, W., Herrman, S.: Computer Simulation of Hydroplaning Effects on Geometric Design – Optimization Strategies for Road Sections with Critical Rainwater Drainage, 3rd International SIIV Congress, Bari, 2005
- [10] Ong, G.P., Fwa, T.F.: Transverse Pavement Grooving against Hydroplaning, I: Simulation Model, Journal of Transportation Engineering, 132 (6), pp. 441-448, 2006
- [11] Krajina, M., Hrvatin, D., Deluka-Tibljaš, A.: Nova metoda ohrapljivanja površine kolnika, Osmo Hrvatsko savjetovanje o održavanju cesta, Hrvatski cestar, Zagreb, pp. 143-148, 2014 (in Croatian)







## EFFECT OF TYPE OF MODIFIED BITUMEN ON SELECTED PROPERTIES OF STONE MASTIC ASPHALT MIXTURES

Marta Wasilewska<sup>1</sup>, Krzysztof Blazejowski<sup>2</sup>, Przemyslaw Pecak<sup>3</sup>

<sup>1</sup> Bialystok University of Technology, Poland

<sup>2</sup> Orlen Asphalt Sp. z o. o, Poland

<sup>3</sup> TPA Sp. z o. o., Poland

### Abstract

Wearing course is the layer directly in contact with traffic loads and weather conditions. It should be resistant to water and frost, plastic deformations and meet the required threshold of skid resistance. SMA (Stone Mastic Asphalt) is one of the most popular mixture intended for wearing courses of road pavement for very heavy traffic loads. Therefore it contains materials of superior quality. This paper presents the experimental results of selected properties of SMA11 with two typical modified binders (ORBITON PMB 45/80-55, ORBITON PMB 45/80-65) and newly developed highly modified binder (ORBITON PMB 45/80-80 HiMA). These modified bitumens have similar penetration range but they differ in the type of polymer and its contents. Therefore that significantly affects on the differences in standard and functional parameters such as elastic recovery, force ductility etc. The primary purpose of highly-modified binders (HiMA type) is to counteract pavement cracking, plastic deformations and consequently to increase the life span of asphalt courses. It should be noted that tested SMA mixtures had the same aggregate particle-size distribution of mineral mixtures. The study of SMA aimed at determination of the water sensitivity expressed in ITRR (Indirect Tensile Strength Ratio) according to the standard 12697-12 (method A) and rutting resistance according to standard EN 12697-22 in the small apparatus (method B). Comparison of the results of those tests showed some differences between binders and mixtures. Specific situation was observed with rutting resistance where strong SMA skeleton decreased influence of binder type. In addition, evaluation of the skid resistance mixtures of the tested SMA were carried out using the Wehner/Schulze machine. Results may be valuable information for proper maintenance of existing pavements and on the stage of designing.

*Keywords: Highly Modified Asphalt, Stone Mastic Asphalt, Polymer Modified Bitumen, wearing course, Wehner/Schulze machine*

### 1 Introduction

SMA (Stone Mastic Asphalt) is widely used mixture intended for wearing courses of road pavement for very heavy traffic loads in Poland. The primary advantage of wearing course made of SMA is to ensure very good resistant to water and frost, better rutting resistance than conventional dense-graded asphalt mixtures [1]. This is possible because the SMA is gap-graded asphalt mixture which is characterized by a strong skeleton due to the high content of superior quality coarse aggregate in the mineral mixture (from 70 to 80%). Additionally, the amount of coarse aggregate allows to achieve high macrotexture. Due to that fact wearing course made of SMA mixture has better skid resistance at high speeds than asphalt concrete mixture [2]. However skid resistance depends on both macrotexture and microtexture. Due to the low

amount of fine aggregates used, microtexture of SMA mixtures is almost completely related to resistance to polishing of coarse aggregates [3]. Therefore aggregates with PSV (Polished Stone Values) above 50 should be used for SMA mixtures in order to meet the required level of skid resistance.

However durability of wearing course made from SMA mixtures is especially related to the type of binder. In weather conditions characterized by very frequent cycles of freezing and thawing only modified bitumen should be applied for SMA mixtures. It allows to achieve higher durability than with paving grade bitumens (unmodified).

Studies have shown that the increasing content of the polymer in asphalt significantly improves durability of road pavement [4-7]. However such a significant quantity of SBS for binder modification must consider its specific technical consequences for the production and application of modified binder. Research conducted in the United States have led to the development of highly modified binder. The primary purpose was to counteract pavement cracking, plastic deformations and consequently to increase the fatigue resistance of asphalt courses. To achieve that, high polymer content in excess of 7% (by weight) is used, which leads to volumetric phase reversal in the mixture of binder with the polymer. Then continuous polymer network works in asphalt mixtures like an elastic reinforcement which limits crack propagation, low-temperature cracking and improving rutting resistance [8, 9].

This paper presents the comparison of selected properties of SMA 11 mixtures with two typical modified bitumens and highly modified binder.

## 2 Research program

### 2.1 Polymer modified bitumen

In this study two conventionally SBS modified binders (ORBITON PMB 45/80-55, ORBITON PMB 45/80-65) and newly developed highly modified binder (ORBITON PMB 45/80-80 HiMA) were used. All PMBs are produced according to EN 14023 and Polish National Annexe to this standard. These modified bitumens have similar penetration range (45-80 [0.1 mm]) but they differ in the type of polymer and its content. Therefore it significantly affects the differences in Softening Point R&B and other parameters such as elastic recovery and force ductility. Table 1 shows properties of the tested modified bitumen.

**Table 1** The results of selected properties of tested modified bitumen

Property	Test method	ORBITON PMB 45/80-55	ORBITON PMB 45/80-65	ORBITON PMB 45/80-80 HiMA
Penetration at 25 °C [0.1 mm]	EN 1426	65	57	63
Softening point R&B [°C]	EN 1427	55.8	80	94.5
Breaking point (Fraass) [°C]	EN 12593	not tested	not tested	-23
Elastic recovery at 25°C [%]	EN 13398	74	87	94
Force ductility at 10°C [J/cm <sup>2</sup> ]	EN 13589 EN 13703	not tested	not tested	5.5

### 2.2 SMA11 mixtures

Tested SMA11 mixtures with three types of modified bitumen (ORBITON PMB 45/80-55, ORBITON PMB 45/80-65, ORBITON PMB 45/80-80 HiMA) were designed according to EN 13108-5

and Polish National Specification WT-2: 2014. Fine and coarse aggregates produced from melaphyre rock were used. PSV (Polished Stone Value) of coarse aggregate was 52. Each of SMA11 mixtures was designed with the same binder content – 6.6 % (by weight) and aggregate particle-size distribution in mineral mixtures (Table 2). Volumetric parameters of SMA11 mixtures are presented in Table 3.

**Table 2** Aggregate particle-size distribution

Particle size distribution								
Sieve [mm]	0.063	0.125	2	4	5.6	8	11.2	16
Passing fraction [%]	10.6	13	25	33	40	61	96	100

**Table 3** Volumetric parameters of SMA 11 mixtures

Parameters	Test method	SMA 11 PMB 45/80-55	SMA 11 PMB 45/80-65	SMA 11 PMB 45/80-80 HiMA
Density $\rho_{mv}$ [Mg/m <sup>3</sup> ]	EN 12697-5	2.417	2.419	2.410
Bulk density $\rho_{bssd}$ [Mg/m <sup>3</sup> ]	EN 12697-6	2.361	2.347	2.340
Air voids $V_m$ [%]	EN 12697-8	2.3	3.0	2.9
Voids filled with Binder VFB [%]	EN 12697-8	86.5	83.2	83.6
Voids in mineral aggregate VMA [%]	EN 12697-8	17.2	17.8	17.7

## 2.3 Experimental procedure

### 2.3.1 Water sensitivity test

Water sensitivity test of SMA11 mixtures was carried out according to EN 12697-12 (method A) and Polish National Specification WT-2:2014. Ten specimens for each mixture were divided into two parts: “dry set” and “wet set”. Specimens from “dry set” were conditioned at temperature 20±5°C. Specimens from “wet set” were saturated with distilled water under vacuum (6.7±0.3 kPa, 30 minutes) and left in water for 30 minutes under atmospheric pressure. Then specimens were conditioned in water at temperature 40°C for 72 hours. In next step plastic-foiled specimens were freezed in -18°C for 16 hours, than they were put in water at temperature 25°C for 24 hours. Finally the ITS (Indirect Tensile Strength) test in accordance with EN 12697-23 on both sets of specimens has been conducted. The ITSr values was calculated according to Eq (1).

$$ITSr = \frac{ITSw}{ITSd} \cdot 100\% \quad (1)$$

where:

ITSd – mean values of ITS for specimens from “dry set” [kPa];

ITSw – mean values of ITS for specimens from “wet set” [kPa].

### 2.3.2 Rutting test

Rutting resistance of SMA mixtures was conducted according to EN 12697-22 in small apparatus (method B), in air. Two specimens from each mixture were prepared. Before testing specimens were conditioned at 60°C for 4 hours. The apparatus consists of the loaded wheel that repeatedly passes over the test specimen. The load of wheel was 700 N, frequency of 26.5±1.0 load cycles per minute. Test was performed at 60°C during the test. Evaluation of resistance to rutting is made on the basis of:

- RD (rut depth) after 10 000 cycles [mm];
- PRD (proportional rut depth) after 10 000 cycles as a percentage of the specimen thickness [%];
- WTS (wheel-tracking slope) [mm/10<sup>3</sup> load cycle].

### 2.3.3 Skid resistance test

The Wehner/Schulze machine (Fig. 1a) was used for evaluation of the skid resistance in laboratory conditions. The machine consists of two heads: one for polishing and for measurement of friction coefficient PWS. Three specimens from each mixture were made. The polishing action is performed by means of three rubber cones mounted on rotary disc and rolling on the specimen surface (Fig. 1b). The rotation frequency is 500 tours per minute. A mix of water with quartz powder was projected on the specimen surface during the rotations. Measurement of friction coefficient PWS is conducted after polishing and then washing of a specimen. The second measuring head is composed of three small rubber sliders disposed at 120° on a rotary disc (Fig.1 c). The disk rotates at tangential velocities up to 100 kph. Water flows over the surface being tested. The rotating disk is then dropped onto the wet surface and the coefficient of friction is measured. In this study coefficient of friction PWS at slip speed 60kph was taken. Measuring of PWS was conducted before polishing and after 2000, 4000, 6000, 8000, 10 000, 12 000, 14 000, 16 000, 18 000, 20 000, 40 000, 60 000, 80 000, 100 000, 160 000, 180 000 passes of polishing head.

It should be noted that Wehner/Schulze machine enables to compare the skid resistance of different types of mixtures under specified conditions simulating polishing processes. In the case of new asphalt specimens it is recommended to clean bitumen from aggregates by using the grid blasting cabinet. Due to the fact that objective of the study is influence of different types of bitumen on the properties of the mixtures, this operation was not performed.



Figure 1 a) Wehner/Schulze machine; b) polishing rotary head; c) friction measuring rotary head

## 3 Results and analysis

ITSR results were similar for all mixtures: SMA11 PMB 45/80-55 – 98%, SMA11 PMB 45/80-65 – 95% and SMA11 45/80-80 HiMA – 99%. However the results of the ITS values show some significant differences between particular mixtures which depend on the type of binder. Graphical interpretation of ITS test results is shown in Fig. 2.

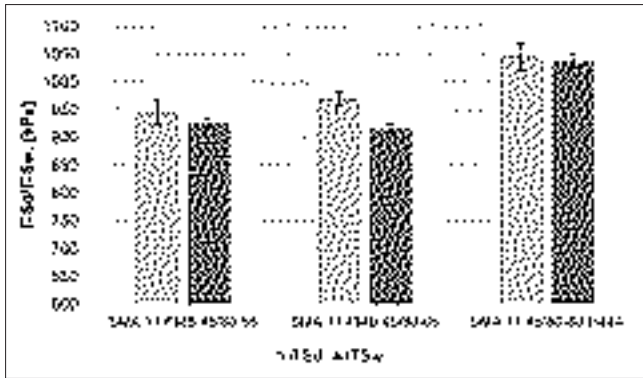


Figure 2 Mean values of ITS with 95 % with confidence interval

The highest value of ITS was obtained for SMA11 PMB 45/80-80 HiMA. Differences between mean values of ITSD and ITSw are insignificant for highly modified binder, about 10% higher than for mixtures with lower SBS content.

SMA11 mixtures have comparable resistance to rutting. The results obtained are the following: RD – 1.5 mm; PRD – 3.8%; WTS – 0.03 [mm/10<sup>3</sup> load cycle]. This was caused by very strong SMA skeleton based on stone-to-stone contact which decreased influence of the binder type. The changes of the friction coefficient PWS are presented in Fig. 3.

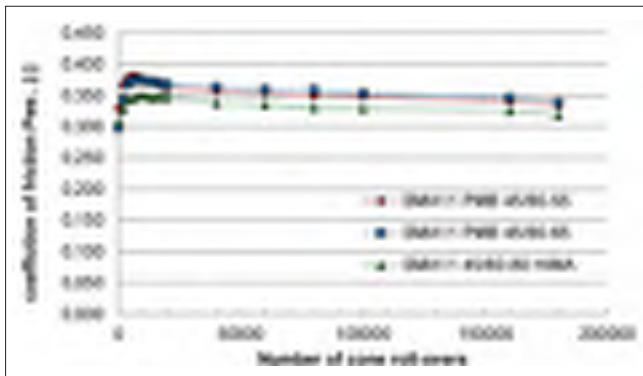


Figure 3 Changes of the friction coefficient PWS in polishing process

The lowest values of PWS have been registered before polishing process, because aggregate surface was covered with binder layer. During polishing process binder was worn away from the aggregate exposing their virgin microtexture. This takes place in the initial stage of the process. The highest values of PWS were obtained after 8000 passes of polishing head. Then it was followed by the decrease in the value PWS for each mixture. However SMA 11 PMB 45/80-55 and PMB 45/80-65 had higher coefficient of friction PWS than SMA11 with highly modified binder. Images of the surface were taken with the optical microscope at the end of polishing process for better understanding of phenomena occurring on the surface of mixtures. Based on observations it was noticed that the binder covering aggregate was not completely removed from each mixture. However a much larger surface of coarse aggregate was discovered on SMA11 mixtures with typical modified binders than highly modified binder (Fig. 4). This caused lower PWS for SMA11 45/80-80 HiMA in comparison with other test mixtures.

Binder layer on the coarse aggregates contributes to the slipperiness during the initial period of pavement life. That is why should be applied gritting from aggregate of nominal size 4 mm

during compacting of SMA mixture. This treatment accelerates wear of the coarse aggregates from the asphalt and ensures increase of initial skid resistance [1]. Obtained results show that the use of highly modified bitumen could lead to extend the time needed to expose aggregate surface.

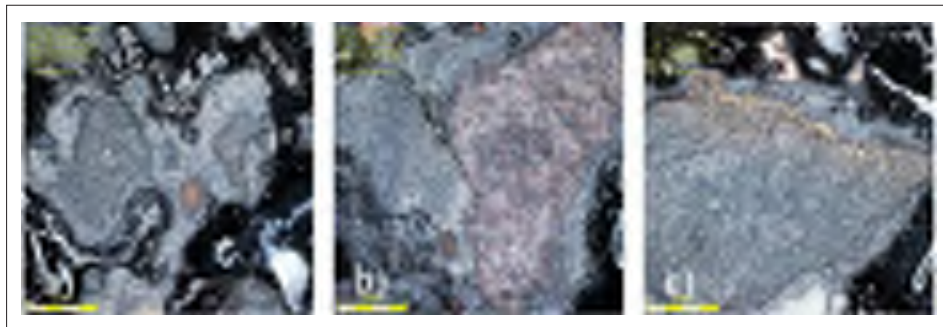


Figure 4 Comparison surfaces of SMA11 a) PMB 45/80-80 HiMA b) PMB 45/80-65 c) PMB 45/80-55

## 4 Conclusions

The type of modified binder plays important role in durability of road pavements. Highly modified binder which has been used in Poland since 2015 may improve fatigue life, rutting resistance and low-thermal cracking resistance. Therefore this type of modified bitumen should be used to SMA mixture which is intended for wearing course for very heavy traffic load. However control of skid resistance properties should be monitored in the initial period of pavement life.

## References

- [1] Blazejowski, K.: Stone Matrix Asphalt. Theory and Practice. CRC Press., 2010.
- [2] Wasilewska, M., Gardziejczyk, W., Gierasimiuk, P.: Assessment of skid resistance using DFTester and CTMeter. 9th International Conference "ENVIRONMENTAL ENGINEERING", Vilnius, 2014
- [3] Gardziejczyk, W., Wasilewska, M.: Assessment of skid resistance of asphalt mixture in laboratory conditions. ARCHIVE OF CIVIL ENGINEERING 58 (2012) 4, pp.521-534
- [4] Xiaohu, L., Isacsson, U.: Modification of road bitumens with thermoplastic polymers. POLIMER TESTING 20 (2000) 1, pp. 77-86
- [5] Airey, G. D.: Rheological properties of styrene butadiene styrene polymer modified road bitumens. FUEL 82 (2003) 14, pp. 1709-1719
- [6] Airey, G. D.: Styrene butadiene styrene polymer modification of road bitumens. JOURNAL OF MATERIALS SCIENCE 39 (2004) 3, pp.951-959
- [7] Bulatovic, V. O., Rek, V., Markovic, K. J.: Effect of polymer modifiers on the properties of bitumen. JOURNAL OF ELASTOMERS & PLASTICS 1 (2013), pp. 1-22
- [8] Błażejowski, K., Olszacki, J., Peciakowski, H.: Highly Modified Bitumens ORBITON HiMA Handbook. ORLEN Asfalt, 2015
- [9] Błażejowski, K., Wójcik-Wiśniowska, M., Olszacki, J., Peciakowski, H.: The performance of a Highly Modified Binders for heavy duty asphalt pavements. 6th European Transport Research Conference MOVING FORWARD: Innovative Solutions for Tomorrow's Mobility, Warsaw, 2016



## IMPACT ASSESSMENT IN THE PAVEMENT LIFE CYCLE DUE TO THE OVERWEIGHT IN THE AXLE LOAD OF COMMERCIAL VEHICLES

Lúcia Pessoa de Oliveira<sup>1</sup>, Cassio Lima de Paiva<sup>1</sup>, Adelino Ferreira<sup>2</sup>

<sup>1</sup> University of Campinas, School of Civil Engineering, Brazil

<sup>2</sup> University of Coimbra, Department of Civil Engineering, Portugal

### Abstract

Commercial vehicles may have different wheel and axle set ups, usually presenting single or dual wheels, and single-axle or dual or triple tandem-axles. In pavement design, requests caused by these various set ups of wheels and axles are converted into the request of the standard axle, loading 8.17 ton-force, which together make up the Number “N”. Due to mechanical manufacture of axles and wheels, and to ensure that the pavements will not receive excessive point loads that might lead to its rupture, there are set weight limits for axle set ups. In Brazil, the legislation on dimensions and weights of vehicles is Resolution n.º 12, dated February 6, 1998, CONTRAN – National Traffic Council. Despite being established by laws, not all roads are properly invigilated to assure these limits are being respected, such as free access roads, roads with insufficient weighing scales for proper control or urban roads. Although overweight axles may cause damage to vehicles, as well as high operation and maintenance costs, depending on the profile of the conductors, it may be more common to disrespect these limits, which shortens the life cycle of pavements.

This article aims to analyse and compare the effect on the life cycle of the pavement when requested by single axle with single wheels, and single-axles, dual and triple tandem-axles with dual wheels, when the axles have 20%, 35%, 50% and 70% overload Brazilian legal values, according to the equivalences axles for AASHTO and USACE methods.

*Keywords: Flexible pavement, axle load, overweight*

### 1 Introduction

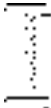


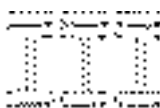
One of the most important parameters for the design of the structure of a pavement is the vehicle traffic that uses the pavement. The traffic on a highway is composed of various types of vehicles with different weights and axle configurations. The maximum weight for axles of vehicles are determined by several factors, such as the strength of the mechanical components and tires used in the vehicles. Other important factor is the limits defined in the design methods of the structures. By respecting the maximum weight, it is unlikely that the pavement structure is requested by a concentrated load, higher than the pavement resistance, and able to cause its rupture.

To ensure a safe maximum weight, the weight limits of vehicle axles are stipulated by law and supervised by competent government agencies. In Brazil, the law establishing these limits is the 12<sup>th</sup> Resolution, dated February 6<sup>th</sup>, 1998, from the National Traffic Council – CONTRAN [1]. The supervision occurs in balances for commercial vehicles, usually located in the region next the major highways. Table 1 shows the weight limits for each axle configuration, according to Brazilian regulations.



However, in developing countries such as Brazil, it is common to find vehicles with overweight axles due to the large number of self-employed drivers, whose behavioral profile differs significantly from logistics companies. For the self-employed drivers the short-term costs – such as tolls and fuel – are more significant, and costs in the long-term – such as vehicle maintenance – are less relevant because they have no immediate effect on the drivers' budget, encouraging the overloading of the vehicle, for example.

**Table 1** Maximum legal load according to axles configuration, as 12<sup>th</sup> Resolution (CONTRAN, 1988)

Axle Type	Configuration	Legal Maximum Load [kN]
Single Wheel Single-Axle (SWSA)		58.84
Dual Wheel Single-Axle (DWSA)		98.07
Dual Wheel Dual Tandem-Axle (DWDT)		166.71
Dual Wheel Triple Tandem-Axle (DWTT)		250.07

Another cause of the overload axles can be irregular distribution of the load on the vehicle, accumulating it on only one axle, rather than distributing it. In these cases, in the checkpoints, the driver is instructed to distribute the transported material, and the axles are checked again, and the vehicle released only when the weights for each axle are within the allowed limits. Overloading axles, besides bringing damage to vehicles and tires, will have an effect on the pavement higher than the limits established in the design, which will accelerate the deterioration of the pavement. If the overload is not sufficient to cause the pavement's immediate rupture, it is expected that the overweight accelerates the fatigue process, reducing the pavement's life cycle and therefore the number of requests supported by it.

## 2 Vehicle traffic

The vehicle traffic that the structure must support is quantified by the effect that various vehicles with different axle configurations that use the stretch of the roadway cause in the pavement. To enable the quantification, a fixed pattern vehicle is established. In the case of road pavements, this is taken as the standard 80kN (or 18 kips) dual wheel single-axle. Axles with different weights and configurations to the standard one have its effect on the pavement expressed as a number of repetitions of the reference axle, these are called equivalent wheel load factors – EWLf [2]. In other words, the effects of the axles are recorded as a number of the standard axles passes.

The sum of the equivalent wheel load factors in the axles of each vehicle multiplied by its frequency in traffic flow within a certain period of time results in the number of requests that

the pavement's structure must support within the stipulated period. This value is called the "Number N" and because that direct relationship with the amount of traffic that go on the pavement in a period of time. It is also used as a measure of the life cycle of the structure. In general, heavier axles represent a higher number of passages of the standard axles than lighter axles, therefore the more vehicles with higher axle loads using the pavement structure; the shorter it is expected to be the life cycle of the structure.

### 3 Equivalent Wheel Load Factors – EWLf

The equivalent wheel load factors (EWLF) usually refer to the effect of the vertical tension on the bottom layer of the pavement, to the traction on the bottom fiber of the asphalt layer or on its deflection; since these are the requests suffered by the pavement, which are closely related to the fatigue of the structure. The most common factors are established by the pavement design methods of the American Association of State Highway and Transportation Officials – AASHTO and the U.S. Army Corp of Engineers – USACE.

The Traffic Studies Manual [3] from the National Department of Transport Infrastructure – DNIT, the Brazilian Federal highway agency, presents equations to obtain the equivalent wheel load factors from the methods cited.

For the USACE method, the general equation has the format shown in equation (1). The constants "A" and "B" vary according to the load and type of the analysed axle, as shown in Table 2. "P" is the axle load in ton-force.

$$FC = A \times P^B \quad (1)$$

For the AASHTO method, the general equation has the format shown in equation (2). The constants "A" and "B" vary according to the type of the axle analysed, such as in Table 3. "P" is the axle load in ton-force.

$$FC = \left( \frac{P}{A} \right)^B \quad (2)$$

**Table 2** Constants used to obtain the equivalent wheel load factors for the USACE method

Axle Type	Axle Load [kN]	Constants	
		A	B
Single or Dual Wheel Single-Axle (SWSA or DWSA)	0 – 80	$2.0782 \times 10^{-4}$	4.0175
	$\geq 80$	$1.8320 \times 10^{-6}$	6.2542
Dual Wheel Dual Tandem-Axle (DWDT)	0 – 108	$1.5920 \times 10^{-4}$	3.4720
	$\geq 108$	$1.5280 \times 10^{-6}$	5.4840
Dual Wheel Triple Tandem-Axle (DWTT)	0 – 176	$8.0359 \times 10^{-5}$	3.3549
	$\geq 176$	$1.3229 \times 10^{-7}$	5.5789

**Table 3** Constants used to obtain the equivalent wheel load factors for the AASHTO method

Axle Type	Constants	
	A	B
Single Wheel Single-Axle (SWSA)	7.77	4.32
Dual Wheel Single-Axle (DWSA)	8.17	4.32
Dual Wheel Dual Tandem-Axle (DWDT)	15.08	4.14
Dual Wheel Triple Tandem-Axle (DWTT)	22.95	4.22

## 4 Overload axles

In this study, the adopted overloads were 20%, 35%, 50% and 70% of the Brazilian legal load of single and tandem axles. Using equations (2) and (3), according to the axle load adopted, the equivalent wheel load factors shown in Tables 4 to 7 were calculated.

Tables 4 to 7 show the absolute load on the overloaded axle and the proportion of the factors according to those relating to statutory burden, which represent the growth of the factors in relation to the overload of the analysed axles. The equivalent factors represent the number of repetitions of the pattern of 80 kN axle in accordance with the method, type and load of the axle. Figures 1 and 2 present the results in a graphical form.

**Table 4** Equivalent wheel load factors in overload axles – Single Wheel Single-Axle

Single Wheel Single-Axle (SWSA)	Load [kN]	Equivalent Factors		Proportion	
		USACE	AASHTO	USACE	AASHTO
Legal load	58.84	0.2779	0.3273	100.0%	100.0%
20% overload	70.61	0.5781	0.7195	208.0%	219.8%
35% overload	79.43	0.8806	1.1968	316.9%	365.6%
50% overload	88.26	1.7020	1.8867	612.4%	576.4%
70% overload	100.03	3.7232	3.2399	1339.7%	989.8%

**Table 5** Equivalent wheel load factors in overload axles – Dual Wheel Single-Axle

Dual Wheel Single-Axle (DWSA)	Load [kN]	Equivalent Factors		Proportion	
		USACE	AASHTO	USACE	AASHTO
Legal load	98.07	3.2895	2.3944	100.0%	100.0%
20% overload	117.68	10.2882	5.2634	312.8%	219.8%
35% overload	132.39	21.4911	8.7547	653.3%	365.6%
50% overload	147.10	41.5370	13.8011	1262.7%	576.4%
70% overload	166.71	90.8655	23.6995	2762.3%	989.8%

**Table 6** Equivalent wheel load factors in overload axles – Dual Wheel Dual Tandem-Axle

Dual Wheel Dual Tandem-Axle (DWDT)	Load [kN]	Equivalent Factors		Proportion	
		USACE	AASHTO	USACE	AASHTO
Legal load	166.71	8.5488	1.6424	100.0%	100.0%
20% overload	200.06	23.2346	3.4937	271.8%	212.7%
35% overload	225.06	44.3257	5.6893	518.5%	346.4%
50% overload	250.07	78.9932	8.8002	924.0%	535.8%
70% overload	283.41	156.9232	14.7753	1835.6%	899.6%

**Table 7** Equivalent wheel load factors in overload axles – Dual Wheel Triple Tandem-Axle

Dual Wheel Triple Tandem-Axle (DWTT)	Load [kN]	Equivalent Factors		Proportion	
		USACE	AASHTO	USACE	AASHTO
Legal load	250.07	9.2998	1.5599	100.0%	100.0%
20% overload	300.08	25.7169	3.3670	276.5%	215.8%
35% overload	337.64	49.6127	5.5348	533.5%	354.8%
50% overload	375.10	89.3037	8.6338	960.3%	553.5%
70% overload	425.12	179.5252	14.6417	1930.4%	938.6%

## 5 Comparison and analysis

The increase in equivalent wheel load factors studied for both design methods grows exponentially, as shown in Figure 1, increasing with axle overload, as expected. The equivalent wheel load factors to AASHTO method represent a smaller number of repetitions of the pattern axle when compared to USACE method. In AASHTO method, the growth of its factors increasing overload is similar in all the different axles compositions: by submitting an overload of 20% the factors are 2.1-2.2 times higher than the factor of the legal load and, analogously, overloading 35% makes the factors 3.4-3.7 times higher, as 50% overload 5.3-5.8 times, and finally, overloads 70% 8.9-9.9 times higher factors. That is, an overload of 70% of an axle in any road configuration discussed represents the passage of nearly 10 times the axle passage in its legal load, in the AASHTO method.

The equivalent wheel load factors to USACE method have similar values to those found for the AASHTO method for simple wheels single axle (SWSA), as shown in Figure 2, which differs from other axle configurations, particularly with the increased axle overload. The factors for the USACE method are quite sensitive to the increased axle overload for the dual wheels axle configurations.

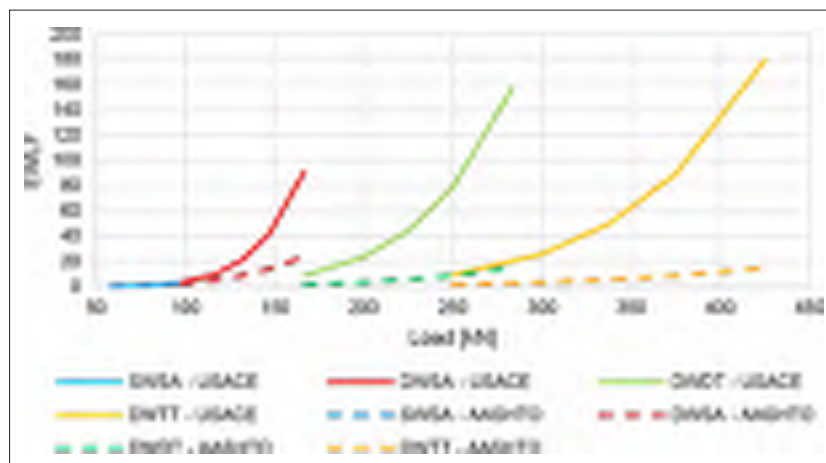


Figure 1 Equivalent wheel load factors in overload axles

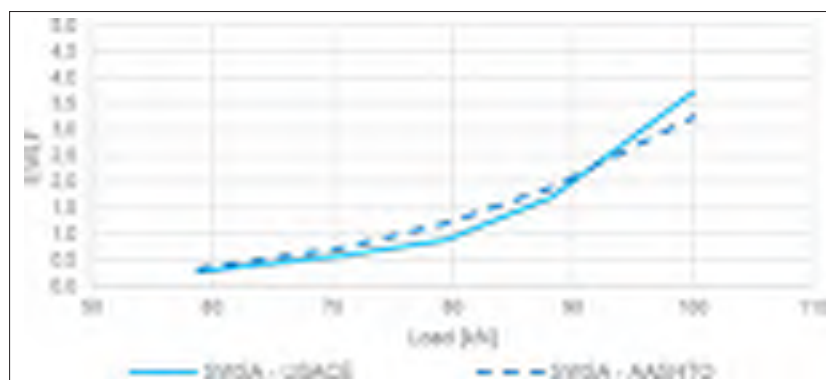


Figure 2 Equivalent wheel load factors in overload axles – Single Wheel Single-Axle

The axles in tandem type configurations, dual and triple tandem-axle, show growth of its factors, in comparison to legal loads, in line with the growth of overload similarly. When the overload is 20%, the factor is 2.7 times the legal load factor, while for 35%, 5.2-5.3; 50%, 9.2-9.6; and with 70% overload, it is 18.3-19.3 times the factor of the legal load.

Although they present smaller USACE equivalent wheel load factors than tandem-axles, the dual wheel single-axles (DWSA) for the USACE method presents the critical equivalent factor growth with the axle overload. With 20% overload the wheel load factor at 3.1 times the one for legal load, and when raised to 35% this multiplier rises to 6.5; when raised to 50% it reaches 12.6 times and finally when it is raised to 70% overload, the factor is 27.6 times the factor for the legal load.

## 6 Conclusion

This study concluded that axles overloading – once they present much larger equivalent wheel load factors than its maximum legal load – will result in a traffic with a “Number N” as higher as the frequency and overload of the axle. Consequently, the number of requests experienced by the pavement can quickly approach the ‘Number N’ established when the structure was designed, which will lead to its early fatigue and, therefore, reduce the life cycle of the pavement.

## References

- [1] CONSELHO NACIONAL DE TRÁFEGO – CONTRAN. Estabelece os limites de peso e dimensões para veículos que transitem por vias terrestres. Resolução n.º 12, de 6 de fevereiro de 1998.
- [2] Yoder, E.J., Witczak, M.W.: Principles of Pavement Design, Second edition, A Wiley-Interscience Publication, Joh Wiley & Sons, Inc. New York, 1975.
- [3] BRASIL. Departamento Nacional de Infra-Estrutura de Transportes – DNIT. Diretoria de Planejamento e Pesquisa – DPP. Coordenação Geral de Estudos e Pesquisa. Instituto de Pesquisas Rodoviárias – IPR: Manual de Estudos de Tráfego – Publicação IPR 723. Rio de Janeiro, 2006.



## QUALITY ASSURANCE OF ASPHALT PAVEMENT

Denisa Cihlářová<sup>1</sup>, Petr Mondschein<sup>2</sup>

<sup>1</sup> VSB- Technical University of Ostrava, Czech Republic

<sup>2</sup> Czech Technical University in Prague, Czech Republic

### Abstract

When laying asphalt layers, the compaction plays an important role. It also ensures the mutual arrangement of the various parts of the asphalt mixture so that the mixture reaches the optimal properties in terms of endurance, strength in terms of climatic conditions; thus guaranteed the desired lifetime period of the layer. The degree of compaction is characterized by the ratio of density found on the layer (destructive, non-destructive) and the reference volume density (Marshall body, control production test of the given section). The paper analyses the destructive and non-destructive methods for checking the degree of compaction of asphalt layers. The data obtained during laying ACO 11+ 50 mm thickness. The volume density was determined by using probes Troxler 3440, Troxler 2701 and from the boreholes in these given locations. According to the analysis accuracy, the probe Troxler 2701 used to determine the final degree of compaction of the construction asphalt layer and for the routine control of compaction is not suitable.

*Keywords: Asphalt mixture, compaction, quality control, destructive method, non-destructive method, Nuclear Density Gauge, Electrical Density Gauges*

### 1 Introduction

The asphalt is a significant building material used both in road constructions and in other building purposes. The first references to using this building material go back to ancient times. The boom of the usage starts at the beginning of 20<sup>th</sup> century with the expansion of the petrochemical industry. Today, it is a widely used material and majority of road communications will not go without it. 97 percent of the road communications have an asphalt cover in the Czech Republic (situation to 1<sup>st</sup> July 2014). Road asphalt layers make the upper part of the non-solid road construction which is exposed to direct vertical and tangential wearing effects of the vehicles, which are then transmitted to further layers of the construction. The upper cover layer (abrasive) is immediately submitted to the effects of atmospheric and climatic influences. Thus, the cover of the road should be waterproof, flat, and should have proper anti-skid qualities so that safe, fast and comfortable drive is ensured. To meet these requirements, it is necessary not only to ensure adequate building material, but also to keep the technology of the construction, otherwise there could be various defects such as adhesion failure among individual asphalt layers [4], and when talking about abrasive layers we mean inadequate surface properties.

### 2 Compaction quality control of asphalt mixtures

A proper compaction of the asphalt mixtures is crucial for reaching the required properties and ensuring the loading capacity, performance and length of life. By the compaction process, the permeability of the mixture decreases, and by this the carrying capacity, weariness and

rutting resistance increases. The extent of compaction depends to a certain level on the base, type of mixture, thickness of layers, used compaction technology, and local conditions during laying. A well-designed and managed compaction process is crucial in order to reach good quality and long lifespan of the asphalt roads and vice versa; inadequate compaction leaves a high percentage of air pores in the road complex of layers, which becomes sensitive to moisture infiltration, oxidation and making of cracks [5, 11]. On the other hand, over-compaction will result in very small amount of air pores in the construction layer, which could lead to asphalt bleeding on the surface of the road in the construction layer during a summer season, or it could result in a crushing of the aggregate, thus change of the mechanical qualities of the road, or rather the construction layer. It follows that when the road is inadequately compacted, we can see a non-standard degradation as a consequence of this, and so a decrease in its length of life. From the above mentioned it follows that the problem of a compaction quality control in the area of quality control or the field of quality assurance, is a highly important process. The technology of compaction process is mainly determined empirically. However, there are studies that try to predict the performance of a mixture during a compaction process in field conditions by various models, see [6]. Finding of the adequate model would enable to design the mixture so that after compaction in the given local conditions, the mixture would have the required qualities. It is evident that the right design, choice of the aggregate and asphalt binders significantly influence the quality of the mixture. Nevertheless, the final quality of the finished road depends on the construction procedures and their control. The compaction control is carried out by two ways, the destructive method (core holes) and non-destructive methods NDG (Nuclear Density Gauge), or EDG method (Electrical Density Gauges). Globally, there is a rise in research particularly in the area of non-destructive tests for determination of the compaction degree, e. g. by using sensors FBG (fibre BraggGrating) [7] or by Intelligent Asphalt Compaction Analyzer (IACA) which uses an artificial neuron net (ANN). By this ANN, the estimated value of the road volume density under a roller during the compaction process is obtained [8]. These two methods of finding the volume density could be characterised as a continuous control of the compaction process; for now they cannot be used as a tool for proving the concordance with the final layer. Though, the advantages of the continuous method cannot be denied. The study focuses on the examination of the achievable compaction quality in the whole length of the roadway. It was discovered that the volume density of the layers of the asphalt road accidentally changes during the compaction process, and it is caused by the re-orienting the aggregate to a random complex structures. Thus, there is 1.9 % possible difference in the density in the areas only 20 cm apart. The control principle of the finished layers is described in the standard ČSN 73 612, in the Czech Republic. The degree of the compaction is possible to control destructively on the boreholes, or after an agreement between the ordering party and the contractor also by the non-destructive method. Depending on the type of the asphalt mixture, the 96 or 98 % compaction degree is required. The asphalt mixtures marked S must reach 98 % of the compaction density in average, and its compaction density cannot decrease below 96 %. The compaction density of the asphalt mixtures with the label + or “without any label” cannot decrease below 96 %.

### 3 Experiment

Individual methods for determination of the compacted volume density of the asphalt layer differs from the point of view of time demands, technical equipment, calibration, principle of determination of the volume density and its exactness. The aim of the experiment was to conduct a comparison of the methods: destructive method, NDG and EDG.

### 3.1 Destructive method

For obtaining core drill holes, the road core drilling machine 60-100 was used. Samples of the 100 mm diameter were acquired by using this machine. After separating the layers, the volume density was determined on the boreholes by using the procedure for a saturated dry surface.

### 3.2 Nuclear Density Gauge (NDG)



Figure 1 Troxler 3440 on the reference block [10]

Measuring by this method was carried out by radio-metric set Troxler 3440. It is a transportable gauge for a fast determination of moisture, density and extent of compaction, especially soils, concrete and asphalt surfaces without disturbing the construction of the measured material. The measuring probe contains shielded Cs 137 source of the 0.3 GBq activity and 241Am/Be of the 1.48 GBq activity. The weight of the NDG is 13 kilograms. Before every measurement, it is necessary to determine the daily calibration response, i.e. radiation intensity. Every 2 years the gauge needs to be inspected long-life stability in the certified laboratory; moreover it is necessary to record monthly dose neutron equivalents of the operators, which are continuously assessed in the national personal dosimetry service. The operators must be trained for work with a radioactive material Fig. 1.

### 3.3 Electrical Density Gauges (EDG)

The non-nuclear sensing device Troxler 2701-B, Pave Tracker TM was used for the measurement. This device is using electromagnetic density indication. The PaveTracker Plus does not contain any radioactive material, and so there is no need for any licence or any special training for operating this gauge. Its weight is approximately 6 kg. A regular calibration every 2 years must be executed in a certified laboratory as well Fig. 2.



Figure 2 Troxler 2701-B, PaveTrackerTM [10]



### 3.4 Course of experiment

The selection of the assessing parameters was chosen in order to make the mutual comparison of individual methods possible. Parameters (time for measurement preparation, time of measuring, volume density assessment time, and other costs) were found out when reconstructing roads in real traffic of the construction and from personal experience. For evaluation of the exactness, at one place the measuring NDG and EDG in both positions was carried out, and at the same place drilling was executed. Data obtained by this measurement were subsequently divided into two evaluating files, which had the same input attributes of the constant thickness and composition of the laying mixture; the measured volume density obtained from the drill was taken as a reference value.

### 3.5 Evaluation exactness

Measuring the level of compaction by all three methods was carried out on five individual sections on the abrasive layers, see Table 1. The compaction intensity is determined as a ratio of the compacted volume density determined on the construction layer and reference volume density determined on the Marshall test body, i.e. cylinder test body. In case of the destructive method, the volume density of the drill and Marshall body are determined by the same method, by using hydrostatic scales. Which means that this method can be considered to be a standard method that has the highest informative value. Both the above described non-destructive methods were compared with the destructive method.

Table 1 Measured sections overview

Section No.	Communication	Construction layer	Layer thickness [mm]	Asphalt mixture
1	III/4673 Štítina – Děhylov	abrasive	50	ACO 11 +
2	II/467 Štítina – Kravaře – Štěpánkovice	abrasive	50	ACO 11 +
3	II/467 Štítina – Kravaře I part	abrasive	50	ACO 11 +
4	II/467 Kravaře – Štěpánkovice II part	abrasive	50	ACO 11 +
5	II/467 Štěpánkovice – Kobieřice III part	abrasive	50	ACO 11 +

The basic statistical parameters of the compacted volume density and the compaction intensity of the compared sections are given in the Table 2. We can conclude that the volume density variance is the smallest in all five assessed cases when determining the boreholes. The difference is by one third smaller when comparing with the non-destructive method by Troxler 3440. At the section number 5, the difference between maximal and minimal measured volume density at the boreholes is four times smaller than by the Troxler 3440 measurement. The Troxler 2701 probe measurement displayed much worse results. The same results can be concluded when comparing compaction intensities determined by three methods. The difference between the compaction density determined on the boreholes and the Troxler 3440 probe is at individual sections equal to: No.1+0.8 %, No. 2 +0.6 %, No. 3 – 1.5%, No. 4 – 1.7%, No.5 – 0.8%. The difference between compaction density determined on the boreholes and the Troxler 2701 probe is substantially higher, it reaches even ca. 6 %.

The compaction density assessment with the demand of the norm ČSN 73 6121, which requires minimal compaction intensity of 96 % for the mixture ACO 11 is displayed in the Table 3. During checking tests carried out on the holes, it was possible to state that all five sections were compacted enough in their whole lengths. When evaluating the compaction density by the non-destructive probe Troxler 3440, exactly the same result can be concluded. When assessing the compaction density by the non-destructive probe T 2701, the number of satisfactory measurement was 23 out of 55.

**Table 2** Statistical assessment of the volume densities and compaction degree

Section No.	No. of measurement		Volume density in [kg/m <sup>3</sup> ]			Compaction intensity [%]		
			Troxler 3440	Troxler 2701	Bore hole	Troxler 3440	Troxler 2701	Bore hole
1	8	min.	2 261	2 089	2 294	96,6	89,3	98,0
		mean	2 301	2 187	2 319	98,3	93,5	99,1
		max.	2 356	2 302	2 357	100,7	98,4	100,7
		min. – max.	95	213	63	4,1	9,1	2,7
2	7	min.	2 258	2 078	2 274	96,3	88,7	97,5
		mean	2 287	2 192	2 301	97,6	93,5	98,2
		max.	2 328	2 305	2 324	99,8	98,8	99,2
		min. – max.	70	227	50	3,5	10,1	1,8
3	10	min.	2 284	2 259	2 274	97,9	96,8	97,5
		mean	2 328	2 286	2 292	99,8	98,0	98,3
		max.	2 365	2 331	2 310	101,4	99,9	99,1
		min. – max.	81	72	36	3,5	3,1	1,6
4	14	min.	2 250	2 214	2 284	96,1	94,5	97,5
		mean	2 335	2 260	2 296	99,7	96,5	98,0
		max.	2 393	2 306	2 323	102,2	98,4	99,2
		min. – max.	143	92	39	6,1	3,9	1,7
5	16	min.	2 284	2 128	2 309	96,9	90,2	97,9
		mean	2 313	2 170	2 317	98,1	92,0	98,2
		max.	2 345	2 206	2 324	99,4	93,6	98,6
		min. – max.	61	78	15	2,5	3,4	1,7

**Table 3** Compaction density comparison with the standard requirements and mutual comparison of CD

Section No.	No. of Measurement	No. of measurements with CD ≥ 96 %			CD borehole > CD Troxler 3440	CD borehole > CD Troxler 2701
		T 3440	T 2701	Borehole		
1	8	8	2	8	7	7
2	7	7	1	7	5	6
3	10	10	10	10	1	6
4	14	14	10	14	1	12
5	16	16	0	16	10	16

### 3.6 Multi-criteria evaluation

In order to determine the density, the quantitative method of pair comparison (the Saaty's method) was used. The degree of importance of individual criteria was determined on the basis of empiric experience of the authors, see Table 4. To determine the order of advantages of individual methods from the point of view of the chosen criteria, the method of the Weight sum product – WSA was used, see Table 5.

Table 4 Pair preference of the criteria

	Measurement accuracy	Price 1 measurement	Equipment price	Price adjustment	Time measurement	Time calibration	Activation time	Time finding density	Maintenance	Energy	Additional equipment	Weight	Other
Measurement accuracy	1	9	9	9	9	9	9	9	9	9	9	9	9
Price 1 measurement	1/9	1	5	7	5	9	9	7	9	9	9	9	9
Equipment price	1/9	1/5	1	7	5	9	5	5	5	7	5	9	9
Price adjustment	1/9	1/7	1/7	1	1/3	5	1/3	1/5	1	1	1/5	1/5	1
Time measurement	1/9	1/5	1/5	3	1	9	7	5	5	7	5	9	9
Time calibration	1/9	1/9	1/9	1/5	1/9	1	1/7	1/9	1/7	1/5	1/7	1/9	1/3
Activation time	1/9	1/9	1/5	3	1/7	7	1	1/5	1/7	1/5	3	3	3
Time finding density	1/9	1/7	1/5	5	1/5	9	5	1	5	7	5	9	9
Maintenance	1/9	1/9	1/5	1	1/5	7	7	1/5	1	1	1/5	3	3
Energy	1/9	1/9	1/7	1	1/7	5	5	1/7	1	1	1/5	1	1
Additional equipment	1/9	1/9	1/5	5	1/5	7	1/3	1/5	5	5	1	5	9
Weight	1/9	1/9	1/9	5	1/9	9	1/3	1/9	1/3	1	1/5	1	1
Other	1/9	1/9	1/9	1	1/9	3	1/3	1/9	1/3	1	1/9	1	1

Table 5 Multi-criteria method evaluation of the volume density determination on construction

	Measurement accuracy	Price 1 measurement	Equipment price	Price adjustment	Time measurement	Time calibration	Activation time	Time finding vol. weight	Maintenance	Energy	Additional equipment	Weight	Other	u (Ai)	Place
Troxler 3440	0,8	0,9	0,9	0	0,9	0	0,8	0,8	0,6	1	1	0,8	0,8	0,83	1
Troxler 2701	0	1	1	1	1	1	1	0,9	1	1	1	0,9	0,8	0,72	2
Drill Core	1	0	0,3	1	0	1	0,1	0,1	0,8	0,8	0,8	0	0,5	0,44	3
Scales	0,28	0,18	0,12	0,02	0,09	0,01	0,02	0,18	0,03	0,02	0,04	0,02	0,01		

The order assessed by the WSA method is as follows, the most suitable method of the volume density determination according to the chosen criteria was the Troxler 3440 machine. Even though the exactness was unsatisfactory, The Troxler machine 2701 is the second most suitable method. The third place is taken by the method of volume density determination by using core holes. This destructive method is necessary especially when handling the construction for determination of the layer thickness and their connections. According to the standard, the core holes are carried out every 1,500 m<sup>2</sup>. It is without doubt that by this method we obtain the most reliable values of the volume density; still this method is both equipment and time-demanding.

## 4 Conclusion

From the analysis of the measured results of the compacted volume densities, or more precisely the compaction degree, we can state that the biggest informative value has the determination of the compaction intensity by the destructive method on the boreholes. In case of resolving tests it is possible to use only this method. The non-destructive method, when the compaction degree is determined by the Troxler 3440 machine, is feasible in the process of compacting, and even when controlling the work performed. The results of the compaction intensity can differ from the real degree by ca 1%. When measuring the degree of compaction by radio-metric probe, it would be advisable that the obtained compaction degree was on the level of 99%, or rather 97% depending on the type of the asphalt mixture. From the presented results, we can state that the second machine, i. e. Troxler 2701 probe does not reach sufficient exactness, not even the repeating measurement. It is neither possible to recommend it for the determination of the final compaction degree of the construction asphalt layer, nor for the continuous inspection of the compaction.

## Acknowledgement

The paper was elaborated with the support of the Competence Centre programme of the Technology Agency of the Czech Republic within the Centre for Effective and Sustainable Transport Infrastructure, the project number TE01020168 and KATHOLISCHER AKADEMISCHER AUSLÄNDER-DIENST (KAAD).

## References

- [1] Stehlik, D., Dasek, O., Hyzl, P., Coufalik, P., Krcmova, I., Varaus, M.: Pavement construction using road waste building material – from a model to reality. In: *Road Materials and Pavement Design*. 2015, vol. 16, pp. 314-329, ISSN 1468-0629.
- [2] Komacka, J., Remisova, E., Liu, G., Leegwater, G., Nielsen, E.: Influence of reclaimed asphalt with polymer modified bitumen on properties of different asphalts for a wearing course. In: *Proceedings of the 3<sup>rd</sup> International Conference on Transportation Infrastructure*, 2014, pp. 179 -185, ISBN 978-1-315-75712-4.
- [3] Wu, S.P., Zhong, J.J., Zhu, J.Q., Wang, D.M.: Influence of demolition waste used as recycled aggregate on performance of asphalt mixture. In: *Road Materials and Pavement Design*. 2015, vol. 14, pp. 679-688, ISSN 1468-0629.
- [4] Hamzah, M.O., Kakar, M.R., Quadri, S.A. Valentin, J.: Quantification of moisture sensitivity of warm mix asphalt using image analysis technice. In: *Journal of Cleaner Production*, 2014, vol. 68, pp. 200-208, ISSN 0959-6526.
- [5] Arambula, E., Masad, E., Martin, A.: Influence of Air Void Distribution on the Moisture Susceptibility of Asphalt Mixes. In: *Journal of Materials in Civil Engineering*. 2007, vol. 19(8), pp. 655–664, ISSN 0899-1561.
- [6] Koneru, S., Masad, E., Rajagopal, K.R.: A thermomechanical framework for modeling the compaction of asphalt mixes. *Mechanics of Materials* [online]. 2008, 40(10): pp. 846-864 [cit. 2015-08-04]. DOI: 10.1016/j.mechmat.2008.03.008. ISBN 9780077221409. ISSN 01676636.
- [7] Yiqiu, T., Haipeng, W., Shaojun, M., Huining, X.: Quality control of asphalt pavement compaction using fibre Bragg grating sensing technology. *Construction* [online]. 2014, 54: pp. 53-59 [cit. 2015-08-04]. DOI: 10.1016/j.conbuildmat.2013.12.032. ISSN 09500618.
- [8] Beainy, F., Commuri, S., Zaman, M.: Quality Assurance of Hot Mix Asphalt Pavements Using the Intelligent Asphalt Compaction Analyzer. *Journal of Construction Engineering* [online]. 2012, 138(2): pp. 178-187 [cit. 2015-08-04]. DOI: 10.1061/(ASCE)CO.1943-7862.0000420. ISSN 07339364. ICalC

- [9] Beainy, F., Singh, D., Commuri, S., Zaman, M.: Laboratory and Field Study on Compaction Quality of an Asphalt Pavement. *International Journal of Pavement Research* [online]. 2014, 7(5): pp. 317-323 [cit. 2015-08-04]. DOI: 10.6135/ijprt.org.tw/2014.7(5).317. ISSN 19971400.
- [10] Špilak, L.: Stanovenie miery zhutnenia asfaltových vrstiev deštruktívnymi a nedeštruktívnymi metódami a ich porovnávaním. Ostrava, 2015. Diplomová práca. VŠB – TU Ostrava.
- [11] Čápayová, S., Zuzulová, A., Bačová, K.: Properties of asphalt mixtures with reclaimed material in Slovakia. In: *Proceedings of the 4<sup>th</sup> International Conference on GreenBuilding, Materials and Civil Engineering, GBMCE 2014*, pp. 17-20.



## EFFECT OF MOISTURE CONTENT AND FREEZE-THAW CYCLES ON BEARING CAPACITY OF RAP/NATURAL AGGREGATE MIXTURES

Josipa Domitrović<sup>1</sup>, Tatjana Rukavina<sup>1</sup>, Sanja Dimter<sup>2</sup>

<sup>1</sup> University of Zagreb, Faculty of Civil Engineering, Croatia

<sup>2</sup> University of Josip Juraj Strossmayer in Osijek, Faculty of Civil Engineering, Croatia

### Abstract

Unbound granular base layer plays a significant role in the overall performance of the pavement structure. It provides structural support for the upper pavement layers, contributes to load distribution and acts as frost protection layer. Traditionally this layer is built with high quality natural aggregate. However, as the sources of natural aggregates are becoming increasingly scarce, engineers are examining the possibilities of using recycled materials. The most widely used recycled material in pavement construction is reclaimed asphalt pavement (RAP) and its possible application in unbound granular base layer has been investigated since the mid-1990s. Previous studies confirmed that RAP can be a suitable replacement for natural aggregate, but there is major concern regarding the impact of seasonal variations in environmental factors on its properties.

The paper analyses effect of changing moisture conditions and freeze-thaw cycling on bearing capacity of natural aggregate (limestone and gravel) and its mixtures with varying RAP percentages (20, 35 and 50%). Bearing capacity was determined by laboratory CBR tests on samples prepared by modified Proctor compaction at optimal moisture content. Three samples for each mixture were prepared and tested after different curing conditions. First sample was tested immediately after compaction, second after 96 hours soaking in water and third after 14 freeze-thaw cycles. Based on the obtained results it can be concluded that the impact of changes in moisture content and freeze-thaw cycling is largely dependent on the type of natural aggregate. Increasing RAP content for mixtures with limestone decreases their sensitivity to changes in moisture content and freeze-thaw cycling. For mixtures with gravel increasing RAP content increases their sensitivity to changes in moisture content and does not affect their sensitivity to freeze-thaw cycling.

*Keywords: unbound granular layer, bearing capacity, reclaimed asphalt pavement, moisture content, freeze-thaw cycling*

### 1 Introduction

Natural aggregates are by far most widely used materials in construction. Approximately 20% of annual aggregate production in Europe, that amounts 2.6 billion tons, is used in the construction of transport infrastructure. Most of the aggregates, about 87%, come from quarries and gravel pits, while the rest comes from marine dredged and industry (5%) or by recycling construction and demolition materials (8%) [1]. Such trend in aggregate production and transport infrastructure construction leads to increase depletion of natural aggregate resources. At the same time, we are faced with disposal of large quantities of construction and demolition (C&D) waste, which in 2012 amount 33% of total waste generated in EU [2]. Because of the

large amounts of C&D waste that are generated and its high potential for reuse (up to 90%) [3] it is necessary to explore new ways for its utilization. Among C&D waste materials one of the most often used recycled materials in pavement construction is reclaimed asphalt pavement. Reclaimed asphalt pavement (RAP) is primary used as replacement for natural aggregate in asphalt mixtures. However, with regard to upper limits of RAP allowed in asphalt mixtures as well as other requirements placed on asphalt mixtures there are still significant amounts of RAP that cannot be utilized in this manner [4]. To avoid disposal of RAP to limited landfills engineers are investigating its possible application in unbound granular base layer as a replacement for natural aggregate. Research conducted so far indicate that use of RAP in unbound base layer is technically viable alternative [5, 6]. However, despite the increased acceptance of RAP/natural aggregate mixtures as unbound base material, limited information's and conflicting reports are available regarding the effect of seasonal frost conditions on RAP properties [7, 8]. Most of research is based on the comparison of materials resilient modulus values before and after freeze-thaw conditioning. Wu [9] and Attia and Abdelrahman [10] reported that resilient modulus of RAP increases after freeze-thaw cycles. It was assumed that the main reason for increase in resilient modulus was decreased in moisture content during sample conditioning and/or testing. In contrast to them, Bozyurt et al [7], Soleimanbeigi et al [8] and Shadiviy [11] reported decrease in resilient modulus after freeze-thaw cycles as a result of particle degradation and progressive asphalt-binder weakening. Because of differences in materials and freeze-thaw conditioning, as well as in methods used to determine resilient modulus it is not possible to make a comparison between conducted researches. The objective of research presented in paper is to evaluate effect of moisture content and freeze-thaw cycling on bearing capacity of RAP/natural aggregate mixtures. The CBR values of mixtures were determinate on samples at optimum moisture content, water saturated samples and samples exposed to freeze-thaw cycles.

## 2 Experimental considerations

Laboratory test program was divided in three parts; design of RAP/natural aggregate mixtures, determination of compaction characteristics and determination of California bearing ratio on samples exposed to different curing conditions.

### 2.1 Mixture design

Research was conducted on mixtures of natural aggregate and reclaimed asphalt pavement. In the mixtures type of natural aggregate (crushed limestone or river gravel) and percentage of RAP (0%, 20%, 35% and 50%) were varied.

In order to obtained mixtures that meet CRO requirements [12] for unbound base aggregate portion of RAP was replaced with different fractions of crushed limestone or river gravel. Since the bearing capacity and sensitivity to frost action is strongly influenced by gradation, two distribution curves were selected for designed mixtures, one for mixtures of RAP with crushed limestone (labelled LRAP%) and other for mixtures of RAP and river gravel (labelled GRAP%). According to designed composition eight mixtures were produced and their particle size distribution was determined in accordance with HRN EN 933-1 [13]. Results of particle size distribution test and CRO gradation requirements are shown in Table 1. In addition to particle size distribution, geometrical characteristics of the mixtures such as maximum particle size ( $d_{max}$ ), coefficient of uniformity ( $C_u$ ) and percentage of fines ( $< 0.02$  mm) were also determined (Table 2).

**Table 1** Mixtures particle size distribution and CRO gradation requirements

Mixture label	LRAP0	LRAP20	LRAP35	LRAP50	GRAP0	GRAP20	GRAP35	GRAP50	CRO req.
Sieve size [mm]	Percentage passing [%]								
31.5	100	100	100	100	100	100	100	100	73-100
22.4	91.64	94.23	94.80	92.03	93.57	91.96	91.75	90.61	-
16.0	83.25	83.03	81.74	76.74	84.09	80.27	81.14	78.69	54-90
8.0	70.46	66.75	61.88	54.37	61.54	60.34	61.74	61.33	40-75
4.0	52.49	47.24	47.24	41.93	40.52	42.66	44.64	44.13	29-60
2.0	34.68	30.57	31.88	28.81	30.15	31.15	30.10	31.36	20-48
1.0	20.80	18.07	18.44	17.13	25.50	25.75	23.00	24.65	13-38
0.500	12.89	11.18	11.25	10.28	22.04	22.05	19.02	20.57	7-28
0.250*	8.49	7.34	7.27	6.61	11.90	12.34	9.76	11.41	3-20
0.125*	6.03	5.13	5.03	4.56	1.92	2.26	1.58	2.14	2-15
0.063	5.46	4.69	4.66	4.20	0.89	1.14	1.10	1.14	-

\*CRO requirements regulates passing through sieve size 0.2 and 0.1 mm

**Table 2** Mixtures geometrical characteristics

Mixture label	LRAP0	LRAP20	LRAP35	LRAP50	GRAP0	GRAP20	GRAP35	GRAP50
$d_{max}$ [mm]	31.5	31.5	31.5	31.5	31.5	31.5	31.5	31.5
$C_u = d_{60}/d_{10}$	16.87	15.76	17.78	20.83	34.12	35.88	29.65	33.29
Fines [%]	3.28	<3.28	<3.28	<3.28	<0.89	<1.14	<1.10	<1.14

As it can be seen in Table 1 all mixtures meet CRO gradation requirements. Maximum particle size for all mixture was 31.5 mm which is less than the maximum allowed 63 mm. Coefficients of uniformity were between 15 and 50 for mixtures with crushed limestone, i.e. 15 and 100 for mixtures with river gravel. Maximum percentage of fines (< 0.02 mm) was 3.28% which is within tolerance limits of CRO specifications. Based on presented results it can be concluded that in terms of particle size distribution and geometrical characteristics RAP/natural aggregate mixtures are suitable for application in unbound base layers.

## 2.2 Compaction characteristics

Compaction characteristics, optimum moisture content (OMC) and maximum dry density (MDD) were determinate by modified Proctor compaction test according to HRN EN 13286-2 [14]. Given the maximum particle size of 31.5 mm, mixtures were compacted with a 4.5 kg rammer in large Proctor mould (B). Results of modified Proctor test are shown in Table 3.

**Table 3** Mixtures optimum moisture content and maximum dry density

Mixture label	LRAP0	LRAP20	LRAP35	LRAP50	GRAP0	GRAP20	GRAP35	GRAP50
OMC [%]	3.8	4.9	4.6	5.2	2.4	2.9	3.3	3.6
MDD [Mg/m <sup>3</sup> ]	2.16	2.13	2.06	2.04	2.22	2.15	2.11	2.12

As it can be seen in Table 3, increase in RAP content results in increase of optimum moisture content and decrease of maximum dry density for all mixtures regardless to the type of natural aggregate. Increase in optimum moisture content may be due to increase in percentage of fines during compaction [15] and decrease in maximum dry density is a result of lower specific gravity of RAP than natural aggregate [16].



## 2.3 Laboratory CBR test

Laboratory CBR test was conducted in accordance with HRN EN 13286-47 [17], on samples compacted by modified Proctor method at optimum moisture content. For each mixture three samples that were exposed to different curing times and conditions before testing were prepared (Fig. 1).



**Figure 1** CBR samples at different stages of conditioning (left, middle) and testing (right)

First sample was tested immediately after compaction as to determine CBR value at optimum moisture content. Second sample was placed in an immersion tank filled with water, at room temperature ( $20 \pm 2$  °C). Pressure gauge was mount on the CBR mould to measure sample vertical expansion, e.g. swelling (Fig. 1, left). Sample was then left to soak in water for 96 hours during which expansion was recorded for every 0.05 mm. On completion of soaking sample was removed from a tank and allowed to drain for 15 minutes before testing. Third sample was placed in cooler with automatic program for freezing and thawing cycles (Fig. 1, middle). One cycle consisted of freezing at -15 °C for 16 hours and 8 hours of thawing at +20 °C. In thawing stage cooler was filled with water to a height of about 5 cm to simulate capillary rise of water. After 14 cycles sample was removed from cooler and left to thaw for 24 hours at room temperature before testing. During 24 hours of thawing, end caps were place on the mould and sealed with tape to prevent water loss by evaporation.

## 3 Results and analysis

The results of CBR test for all tested mixtures and curing conditions are summarised in Table 4. As it was expected from previous studies [15, 16, 18] the CBR value of the mixtures decreases with an increase in RAP content and the rate of decrease depended on the type of natural aggregate. The effect of sample conditioning, changes in moisture content and exposure to freeze-thaw cycles, on bearing capacity of tested mixtures will be analyzed separately.

**Table 4** Results of CBR test

Mixture label	LRAP0	LRAP20	LRAP35	LRAP50	GRAP0	GRAP20	GRAP35	GRAP50
CBR <sub>OMC</sub> [%]	185	74	44	36	110	85	73	53
CBR <sub>96h</sub> [%]	129	62	40	27	75	53	44	29
CBR <sub>FT</sub> [%]	117	54	31	22	28	17	14	12

### 3.1 Effect of moisture content

Change in moisture content of the samples from optimum to saturate resulted in decrease of CBR value ( $\Delta CBR_{MC}$ ) for all tested mixtures. This decrease was calculated as:

$$\Delta CBR_{MC} = \left( 1 - \frac{CBR_{96h}}{CBR_{OMC}} \right) \times 100 [\%] \quad (1)$$

Where:

$CBR_{OMC}$  – is CBR value of samples tested at optimum moisture content,

$CBR_{96h}$  – is CBR value of samples tested after 96 hours soaking in water.

Effect of moisture content on CBR value largely depends on the type of natural aggregate (Fig.2). For mixtures with crushed limestone the largest decrease was obtained on those without RAP, followed by the reduction in decrease for mixtures with 20% and 35% of RAP, and slightly increases for mixtures with 50% of RAP. On mixtures with river gravel smallest decrease was obtained for mixtures without RAP followed by continuous increase with increase in RAP content.

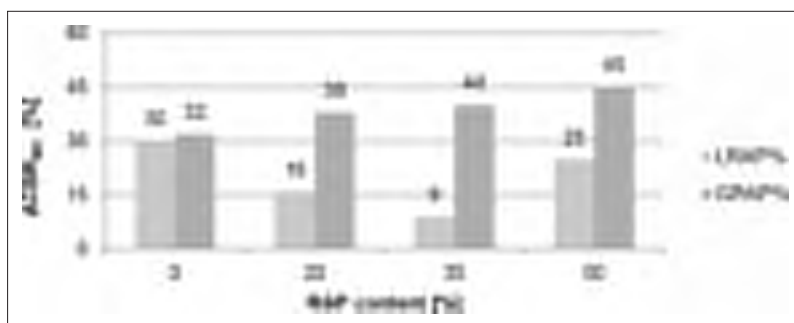


Figure 2 Decrease of CBR value caused by change in moisture content in relation to RAP content

### 3.2 Effect of freeze-thaw cycles

Exposure of samples to freeze-thaw cycles resulted in decrease of CBR value ( $\Delta CBR_{FT}$ ) for all tested mixtures. The decrease was calculated as:

$$\Delta CBR_{FT} = \left( 1 - \frac{CBR_{FT}}{CBR_{OMC}} \right) \times 100 [\%] \quad (2)$$

Where:

$CBR_{OMC}$  – is CBR value of samples tested at optimum moisture content,

$CBR_{FT}$  – is CBR value of samples tested after 14 freeze-thaw cycles.

As it is shown on Fig. 3, decrease in CBR value largely depends on the type of natural aggregate. For mixtures with crushed limestone the largest decrease was obtained on mixtures with 50% of RAP and the lowest on those with 20%. Mixtures with 20% and 35% of RAP had slightly lower decrease in CBR value compared to 100% crushed limestone mixtures. For all RAP/river gravel mixtures decrease in CBR value after freeze-thaw cycles was of a comparable level regardless of RAP content.

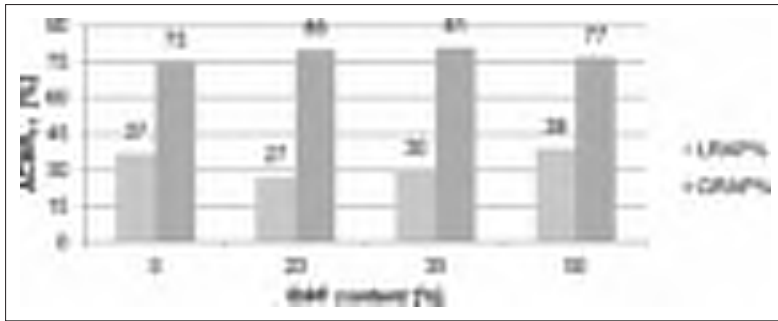


Figure 3 Decrease of CBR value caused by freeze-thaw cycles in relation to RAP content

## 4 Conclusion

Application of RAP in unbound base layers would result in significant economic benefits, substantial reduction in RAP material disposed on landfills and preservation of natural aggregate resources. A major concern in using RAP as an unbound base layer is influence of changing seasonal conditions on its properties. To investigate the effect of change in moisture content and freeze-thaw cycling on RAP/natural aggregate mixtures laboratory CBR test was performed on mixtures of natural aggregate (limestone or gravel) with varying RAP percentages (0, 20, 35 and 50%) exposed to different curing conditions.

Both, the effect of change in moisture content and the effect of freeze thaw cycles on mixtures bearing capacity largely depended on type of natural aggregate. RAP/crushed limestone mixtures were less sensitive to change in moisture content compared to crushed limestone mixture without RAP. For RAP/river gravel mixtures increase of RAP content resulted in an increased sensitivity of mixtures to changes in moisture content. Regarding the effect of freeze-thaw cycles it can be concluded that RAP/crushed limestone mixtures are less sensitive to freeze-thaw cycles if the RAP content is below 50%. For RAP/river gravel mixtures freeze-thaw cycles resulted in reduction of bearing capacity with an average 80% decrease of CBR value. This decrease was not affected by change in RAP content.

RAP/crushed limestone mixtures are suitable for the application in unbound base layers since they are less sensitive to changes in moisture content and freeze-thaw conditioning. However, as these mixtures have lower bearing capacity than mixtures without RAP, their main application would be for low volume roads with thinner asphalt layer where unbound base layers are more exposed to freeze-thaw cycles. Application of these mixtures in high volume roads requires additional testing as well as adjustment of current technical regulations in the field of unbound base layers.

## References

- [1] UEPG, European Aggregates Association: A Sustainable Industry for a Sustainable Europe; Annual Review 2014-2015.
- [2] Europe in figures – Eurostat yearbook; Waste statistics, [http://ec.europa.eu/eurostat/statistics-explained/index.php/Europe\\_in\\_figures\\_-\\_Eurostat\\_yearbook](http://ec.europa.eu/eurostat/statistics-explained/index.php/Europe_in_figures_-_Eurostat_yearbook), 04.01.2016.
- [3] Service Contact on Management of Construction and Demolition Waste, SR1 Final Report Task 2, European Commission, 2011.
- [4] Dong, Q., Huang, B.: Laboratory Evaluation on Resilient Modulus and Rate Dependencies of RAP Used as Unbound Base Material, *Journal of Materials in Civil Engineering*, Vol. 26, No. 2, pp. 373-383, 2014.

- [5] McGarrah, E.J.: Evaluation of Current Practices of Reclaimed Asphalt Pavement/Virgin Aggregate as Base Course Material, Washington State Department of Transportation, 2007.
- [6] Hoppe, E.J., Lane, S.D., Fitch, M.G., Shetty, S.: Feasibility of Reclaimed Asphalt Pavement (RAP) Use as Road Base and Subbase Material, Final Report VCTIR 15-R6, 2015.
- [7] Bozyurt, O., Keene, A.K., Tinjum, J. M., Edil, B.T., Fratta, D.: Freeze-Thaw Effects on Stiffness of Unbound Recycled Road Base, Mechanical Properties of Frozen Soils STP 1568, 2013.
- [8] Soleimanbeigi, A., Shedivy, R.F., Tinjum, J.M., Edil, T.B.: Climatic effect on resilient modulus of recycled unbound aggregates, Road Materials and Pavement Design, Vol. 16, No.4, pp. 836-853, 2015.
- [9] Wu, M.: Evaluation of High Percentage Recycled Asphalt Pavement as Base Course Materials, doctoral thesis, Washington University, Department of Civil and Environmental Engineering, 2011.
- [10] Attia, M., Abdelrahman, M.: Sensitivity of Untreated Reclaimed Asphalt Pavement to Moisture, Density, and Freeze Thaw, Journal of Materials in Civil Engineering, Vol. 22, No. 12, pp. 1260-1269, 2010.
- [11] Shedivy, R.F.: The Effects of Climatic Conditions and Brick Content on Recycled Asphalt Pavement and Recycled Concrete Aggregate as Unbound Road Base, doctoral thesis, University of Wisconsin, Madison, 2012.
- [12] General technical requirements for road work, III Pavement, IGH, Zagreb, 2001.
- [13] HRN EN 933-1: Tests for geometrical properties of aggregates -- Part 1: Determination of particle size distribution -- Sieving method, 2012.
- [14] HRN EN 13286-2: Unbound and hydraulically bound mixtures -- Part 2: Test methods for laboratory reference density and water content -- Proctor compaction, 2012.
- [15] Taha, R., Ali, G., Basma, A., Al-Turk, O.: Evaluation of reclaimed asphalt pavement aggregate in road bases and subbases, Transportation Research Record, No. 1652 (1), pp. 264-269, 1999.
- [16] Cooley, D.A.: Effects of Reclaimed Asphalt Pavement on Mechanical Properties of Base Materials, doctoral thesis, Brigham Young University, Department of Civil and Environmental Engineering, 2005.
- [17] HRN EN 13286-47: Unbound and hydraulically bound mixtures -- Part 47: Test method for the determination of California bearing ratio, immediate bearing index and linear swelling, 2012.
- [18] Stolle, D.F.E., Guo, P., Emery, J.J.: Mechanical properties of reclaimed asphalt pavement – natural aggregate blends for granular base, Canadian Journal of Civil Engineering, Vol. 41 No. 6, pp. 493-499, 2014.





## IMPACT OF WASTE ENGINE OIL AS REJUVENATOR ON UTILIZATION OF RECLAIMED ASPHALT PAVEMENT IN BITUMINOUS MIXTURES

Peyman Aghazadeh Dokandari<sup>1</sup>, Derya Kaya<sup>2</sup>, Ali Topal<sup>2</sup>, Burak Şengöz<sup>2</sup>, Jülide Öner<sup>1</sup>

<sup>1</sup> Dokuz Eylul University, The Graduate School of Natural and Applied Sciences / Turkey

<sup>2</sup> Dokuz Eylul University, Department of Civil Engineering / Turkey

### Abstract

Demand for sustainable pavements increases day by day in asphalt paving industry. Efficient utilization of raw materials along with the economic issues is the main reason to increase the amount of Reclaimed Asphalt Pavement (RAP) in bituminous mixtures. Since RAP is essentially aged material, it is considered not to behave like a fresh pavement. Hence, many researchers have tried to seek for innovative technologies in order to enhance RAP characteristics to utilize it over again. The objective of this study is to investigate the influence of Waste Engine Oil (WEO) on properties of RAP and therefore to determine the optimum amount of RAP in order to achieve desired characteristics of mixture. In this study the mixtures including various contents of RAP, modified with optimum WEO content, were prepared together with control mixtures. Mixture characteristics such as air void contents and Marshall Stability and Flow values were determined to be checked with specification requirements. Indirect Tensile Strength (ITS) values were accordingly measured for mixtures containing high possible amounts of RAP modified with WEO and control specimens. Based on the developed evaluation indices (as the ratio of ITS results of RAP containing specimens modified with WEO to ITS results of control specimens) comparisons were made. The results showed that the use of WEO, as a rejuvenator for mixtures containing RAP, enhanced the amount of RAP used in bituminous mixtures.

*Keywords: asphalt recycling, reclaimed asphalt pavement, rejuvenator, waste engine oil, indirect tensile strength*

### 1 Introduction

Recycling of bituminous materials has generated considerable discussion and development during the last decades. Although it is not a new idea, recent studies appear to be in response to the need of many countries to reduce their dependency on imported crude oil and the derivative product known as bitumen.

Many recent technologies introduce innovative methods for recycling of Reclaimed Asphalt Pavement (RAP). There are many fields of use for RAP from using it as backfill materials to implementation it within pavement superstructure courses. It is important to designate the most valuable field of recycling for RAP. Many studies have addressed many areas of utilization for RAP beside the optimum amount within the mentioned area [1]. Worldwide in addition to science world, within the high petroleum prices period, private sector has developed many methods in order to use RAP with high possible amounts [2]. Although private sector technologies are controlled and confirmed by authorities in accordance with specifications, these technologies are not accessible to the public due to know-how excuses.

Allegedly the United States of America and many other countries have led the technological development of modern recycling methods for RAP. While recycling is not practiced nationwide in USA, now it has become a common practice in many states. Other countries which seem to be interested in developing of recycling processes include Germany, France, Finland, India, South Africa and Turkey [3].

RAP contains both aggregates and bitumen, and hence it saves natural resources while it is and eco-friendly technology [4]. The use of RAP provides an economical solution for paving since it helps saving of both aggregates and bitumen within the new flexible pavement [4]. Therefore, the more the implementation of RAP, the more economical and sustainable pavements are achievable.

Recycling methods can generally be categorized as Cold and Hot recycling [1]. Cold recycling of bituminous mixtures involves RAP, water and a recycling agent in place without applying heat generally by use of emulsions since hot recycling implements heat and generally recycling agents in presence of heat. Both methods can be conducted in production plant or in-place. The common point in most recycling methods is the presence of a recycling agent which paves the way for easier application.

Use of rejuvenators also called recycling agent is one of the most famous methods introduced to facilitate the use of RAP especially within the upper surfaces of flexible pavements such as binder and surface courses [3]. Various kinds of rejuvenators have been introduced to asphalt recycling field so far, some commercialized and some still remained within the literature. These kinds of rejuvenators mostly are used within hot recycling applications. Many of rejuvenators have oily base, since it is believed that aged asphalt lacks the oily component of bitumen during the service life of bituminous pavements [5]. The bitumen is generally defined as a colloid system in which asphaltenes take role as the dispersed phase and maltenes as the continuous phase [6]. The evaporation and removal of oily constituents (mainly as maltenes) plays an important role in aging process of bitumen [7]. It is known that without using of rejuvenators, recycling results in a stiffer and accordingly brittle pavement [8].

Shen et al. (2007) evaluated the using of rejuvenating agents on Superpave mixtures containing RAP. It is reported that the mechanical properties of mixtures involving RAP and rejuvenating agent were improved. Additionally, more amount of RAP could be included within the Superpave mixtures by use of oily based rejuvenators [9].

Asli et al. (2012) investigated the feasibility of waste cooking oil as rejuvenator for recycled mixtures. Authors indicated that the use of waste cooking oil rehabilitated the properties of aged bitumen. It is said that the rejuvenated binder behaved similar to virgin binder in terms of penetration and softening point. The researchers also claimed more amount of RAP within the recycled mixture could be available by implementation of waste cooking oil [10].

Yu et al. (2014) implemented waste vegetable oil and an aromatic extract in order to rejuvenate the aged bitumen. The rejuvenator was used to enhance the rheological properties of the aged binder. It is reported that the use of these agents could modify the chemical structure of the aged binder and thus the mechanical behaviour as well. The researchers evaluated the samples at both macro- and micro-scales and found out that characterization of rejuvenating impact on aged binders could gain the advantage of improved recycling of bituminous materials [11].

In another study, high temperature properties of rejuvenating recovered binder with waste cooking and cotton seed oils was examined [12]. Authors employed the waste cooking and cotton seed oils for rejuvenation of RAP. They reported that use of these rejuvenators could reduce the viscosity value and fail temperature of aged binders. Besides, the rheological studies unveiled an increase of phase angle in rejuvenated binders. The results also proved that, selecting the optimum dosage of rejuvenator can recover the rutting performance of aged binder substantially [12].

Ongel and Hugener (2015) also discovered that the use of rejuvenators can recover the original rheological properties of aged binders to a large extent. The authors claimed that 100% recycling can be a solution for environmental problems under favour of rejuvenators [13].

Nayak and Sahoo (2015) tried two kinds of local oil for rejuvenating aged binders. Panogamia oil and composite castor oil were employed within this study. The rheological evaluation of effect of these rejuvenators on aged binder represented that, these oils are capable of enhancing both rutting and fatigue properties of aged binders [14].

When it comes to Waste Engine Oil (WEO), what literature survey brings to light is that WEO is also amongst the addressed oily based rejuvenators [15], [16]. Zaumanis et al. investigated the performance properties of RAP binder and 100% recycled asphalt mixtures with six different rejuvenators. WEO was employed in order to enhance RAP binder within the scope of this study as well. The authors reported improvement in many aspects such as reducing the performance grade of rejuvenated RAP binder to the level of virgin binder, passing rutting requirement, enhancing of mixture cracking resistance and improved workability for rejuvenated mixtures [15].

WEO was similarly employed within another study conducted by Jia et al. (2015) in order to investigate its influence on the rheological properties of RAP binder as well as fatigue properties of HMA containing RAP. It was reported that the use of WEO within HMA involving RAP can offset the increase of stiffness imposed by aged RAP binder. The authors claimed limited enhancements on fatigue properties of the mixtures containing RAP by use of WEO [16].

The utilization of WEO and its efficiency as stated in literature is the keystone to perform this study so as to investigate its employability with RAP. The objective of this study is to evaluate and establish the rejuvenating effect of WEO, as well as determining the optimum dosage and accordingly utilizing WEO in rejuvenation of RAP to take advantage of high RAP contents within the recycled bituminous mixtures.

## 2 Experimental

### 2.1 Materials

50/70 penetration grade virgin binder provided from Aliğa/Izmir petroleum refinery was used within the scope of this study. This penetration grade is used in the area in accordance with Turkish specifications. In order to characterize the properties of the virgin binder, conventional tests such as: penetration test, softening point test, Rolling Thin Film Oven Test (RTFOT) and etc. were conducted. These tests were performed in conformity with the relevant standards. Results are presented in Table 1.

**Table 1** Properties of virgin binder

Test	Specification	Results	Specification limits
Penetration (25 °C; 0.1 mm)	TS EN 1426	63	50–70
Softening point (°C)	TS EN 1427	49.7	46–54
Viscosity at (135 °C)-Pa.s	ASTM D4402	0.425	–
Viscosity at (165 °C)-Pa.s	ASTM D4402	0.1	–
Rolling Thin Film Oven (163 °C)	TS EN 12607-1		
Change of mass (%)		0.05	0.5 (max)
Retained penetration after RTFO (%)	TS EN 1426	74	50 (min)
Softening point rise after RTFO (°C)	TS EN 1427	4.5	7 (max)
Specific gravity	ASTM D70	1.038	–
Flash point (°C)	TS EN 22592	+260	230 (min)



Limestone aggregates provided from Dere Madencilik / Izmir quarry were employed in mixture tests. The properties of the limestone aggregate specifications such as specific gravity, Los Angeles abrasion resistance, sodium sulphate soundness, fine aggregate angularity and flat and elongated particles are presented in Table 2. Gradation of aggregate was chosen in conformity with the Type I wearing course of Turkish Specifications. Table 3 presents the final gradation table chosen for mixture.

**Table 2** Properties of limestone aggregate

Test	Specification	Result	Specification limits
Specific gravity (Coarse Agg.)	ASTM C 127		–
Bulk		2.704	–
SSD		2.717	–
Apparent		2.741	–
Specific gravity (Fine Agg.)	ASTM C 128		
Bulk		2.691	–
SSD		2.709	–
Apparent		2.739	–
Specific gravity (Filler)		2.732	–
Los Angeles abrasion (%)	ASTM C 131	22.6	max. 30
Flat and elongated particles (%)	ASTM D 4791	7.5	max. 10
Sodium sulphate soundness (%)	ASTM C 88	1.47	max. 10–20
Fine aggregate angularity	ASTM C 1252	47.85	min. 40

**Table 3** Gradation table

Sieve size/No.	Gradation [%]	Specification	Specification limits [%]
19 mm.	100		100
12.5 mm.	92		83–100
9.5 mm.	73		70–90
No.4	44.2	Type I wearing course (Turkish Specification)	40–55
No.10	31		25–38
No.40	12		10–20
No.80	8		6–15
No.200	5.3		4–10

RAP was provided from a reclaimed type I wearing surface course subjected to regular and heavy traffic loads for a period of 12 years. 16 x 1000 gr. batch samples were selected randomly by a random separator and tested for determination of binder content and gradation. Based on the extraction test results, the binder content was found as 4.30 % within the available RAP. RAP binder was extracted by means of a centrifuge extractor and distilled by a distillatory setting to obtain RAP binder. Following the determination of the RAP binder content, sieve analysis was performed on the extracted aggregates. The gradation table for RAP is given in Table 4. The conventional binder test results for extracted RAP binder are presented within the Table 5.

**Table 4** Sieve analysis of RAP

Sieve No	Retained [%]	Passing [%]	Spec. limits [%]
19 mm	0	100	100
12.5 mm	1.6	98.4	83–100
9.5 mm	10.1	89.9	70–90
No.4	45.9	54.1	40–55
No.10	69.8	30.2	25–38
No.40	86.5	13.5	10–20
No.80	91.18	8.82	6–15
No.200	94.17	5.83	4–10

**Table 5** Properties of RAP binder

Test	Specification	Results
Penetration (25 °C; 0.1 mm)	TS EN 1426	38
Softening point (°C)	TS EN 1427	61
Viscosity at (135 °C)-Pa.s	ASTM D4402	0.538
Viscosity at (165 °C)-Pa.s	ASTM D4402	0.188

The rejuvenator employed within this study was provided from a waste and residual oil wholesale trader company who owns the licence for collection of waste oils. In order to obtain a homogenous product, the samples were directly obtained from batch tank which is supposed to be a blend of all waste engine oil brands and types. The wholesaler claims a firm homogeneity for the mentioned tank. WEO is in liquid form at ambient temperature and has a dark brown colour.

## 2.2 Methodology

In this study, the mixtures containing various amounts of non-rejuvenated RAP and rejuvenated RAP (treated with WEO), respectively representing control and rejuvenated specimens were prepared using Marshall compactor. The mechanical performances of the samples were evaluated by Marshall stability and flow test. Besides, volumetric analysis was done and taken into consideration in selection of highest RAP content. Turkish specification limits were taken into account as the main indicator in determination of highest RAP content for both control and rejuvenating samples. Following the determination of highest RAP content; the specimens containing highest RAP content were prepared and tested for Indirect Tensile Strength (ITS) test. Based on ITS values; aging indices were calculated for these specimens and compared to each other. The primary steps in the design of Hot Mix Asphalt (HMA) include the determination of material properties of RAP and virgin materials, the selection of an appropriate percentage of RAP and virgin aggregate to meet gradation, the selection of appropriate binder content to satisfy viscosity and penetration requirements in terms of workability, and to meet the specification requirements in terms of stability, flow and air voids.

### 2.2.1 Determination of target mixtures contents

Marshall mix design method was employed to design virgin bituminous mixtures. The optimum bitumen content was determined 4.76 % by weight of aggregates. In order to implement various contents of RAP within the final mixture, the target bitumen amount supposed to be added to the total mixture was calculated separately for different RAP content. The Eq. (1) was used to determine the amount of virgin binder to be added to the target mixture.

$$Pr = Pc - (Pa * Pp) \quad (1)$$

Where:

- Pr – Percent of virgin binder to be added in the mix containing RAP;
- Pa – Percent of RAP binder in the mix;
- Pc – Percent of total binder in the mix;
- Pp – Percentage of RAP in the mix.

Following the determination of virgin binder amounts to be added into the target mixtures with respect to the values given in Table 6, the asphalt concrete samples including various contents of non-rejuvenated and rejuvenated RAP respectively representing control and rejuvenated specimens were prepared taking the mixing and compaction temperatures into consideration. The mixing and compaction temperatures were calculated using equiviscous temperature charts for virgin, RAP and rejuvenated binders plotted according to viscosity values determined at 135 °C and 165 °C. Viscosity values were measured by means of a Brookfield viscometer.

**Table 6** Binder contents to be added into the target mixes

RAP Content [%]	Pc [%]	Pa [%]	Pr [%]
10			4.33
20			3.9
30	4.76	4.30	3.47
40			3.04
50			2.61
60			2.18
70			1.75
80	4.76	4.30	1.32
90			0.89
100			0.46

### 2.2.2 Determining optimum rejuvenator content and rejuvenation process

Based on the literature review; considering the conventional bitumen test results of virgin and RAP binder, the objective was defined as to rejuvenate RAP binder in order to obtain a binder similar to virgin binder in terms of specifications. Rejuvenator is supposed to enhance and cure the RAP binder. Many studies have addressed the penetration value as an indicator for determining the optimum rejuvenator content [10], [17-19]. Therefore, the optimum content of WEO within the modified RAP binder was determined as the target content to obtain a rejuvenated binder having the same penetration value of virgin binder. In other words, when the RAP binder is modified with this WEO content, the acquired binder will have the same penetration value of virgin binder. In order to perform this task, RAP binder was modified with various dosages of WEO. The range was chosen based on literature review and preliminary studies [16]. Modification was processed for 5 minutes at 140°C using a laboratory blender at normal shear rates (700 rpm) to obtain a homogenous rejuvenated binder. Table 6 consists of penetration test results of rejuvenated binders with various WEO contents. The optimum WEO content was determined as 5.4% by weight of RAP binder corresponding target penetration value of 63. Following the determination of optimum WEO content; RAP mixtures were rejuvenated and stored. In order to perform the rejuvenation process, 4000 gr batches of RAP were heated to 140°C the same temperature in which binder blending took place. The bitumen content of RAP were calculated and taken into account in rejuvenation process. Within the process, the optimum amount of WEO was gradually sprayed into the mixture while mixing was in process

inside a laboratory mixer for 5 minutes. The derived rejuvenated RAP had a shining dark brown colour compared to non-rejuvenated RAP as seen in Fig. 1.

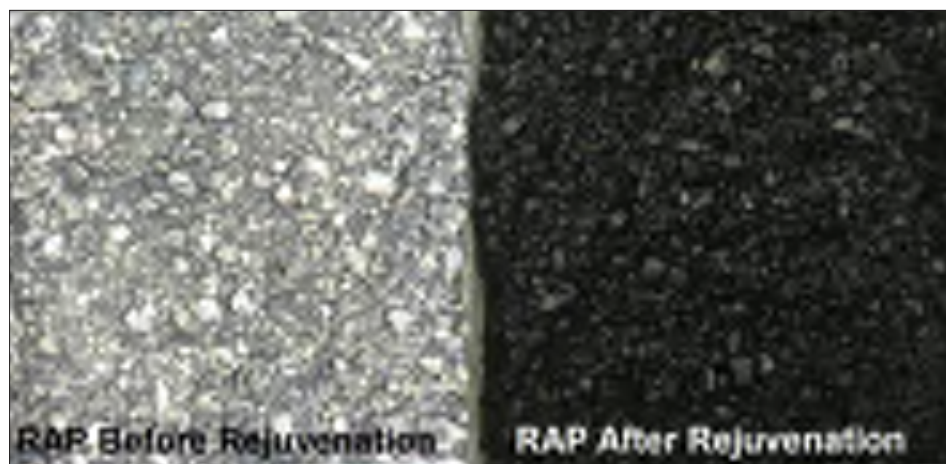


Figure 1 RAP before and after rejuvenation with WEO

Table 7 Penetration values for rejuvenated binders by various WEO content

WEO Content [%] by weight of RAP binder	Specification	Penetration (25 °C; 0.1 mm)
0	TS EN 1426	38
2		44.5
3		49
4		53.5
5		59.5
6		68

### 2.2.3 Indirect tensile strengths and aging evaluation of mixtures

Following the determination of high possible RAP contents for rejuvenated mixtures, specimens were prepared with this RAP content for both rejuvenated and non-rejuvenated mixtures and tested for Indirect Tensile Strength (ITS). To perform this task, ASTM D6931 -the standard test method for indirect tensile strength of bituminous mixtures was taken into account. The ITS test was conducted by Marshall stability and flow apparatus. The loading rate was set to 51(mm/min) in case for ITS.

Fig. 2 illustrates the true assembly of a specimen between loading strips. To be adequate and unbiased, three specimens for both non-rejuvenated and rejuvenated RAP involving mixtures and also control specimens with no RAP content were prepared and tested. The ITS results give the evaluation keys in terms of low temperature and fatigue cracking of asphalt pavements. Some studies introduce ITS result as a good indicator in predicting laboratory rutting potential of asphalt mixtures [20]. This test is widely used in investigation of moisture induced damages of bituminous mixtures.

It is known that, aged binder is more brittle and stiffer. In order to evaluate the aging characteristics of non-rejuvenated and rejuvenated RAP involving mixtures, the ITS results of RAP involving mixtures were compared to the results of control mixtures with no RAP. This comparison simply provides aging indices to investigate the aging characteristics of asphalt mixtures.

Şengoz (2003) implemented ITS results of mixtures with various air voids, to assess aging and moisture susceptibility characteristics of HMA mixtures [21]. Another study on short- and long-term aging behaviour of rubber modified asphalts conducted by Liang and Lee (1996) claimed that the short-term and long-term aging increased the measured tensile strengths [22]. Şengoz and Topal (2008) investigated the effects of SBS polymer modified bitumen on the ageing properties of asphalt mixtures using ITS results [23]. They calculated aging indices as the ratio of short- and long-term aged specimen's ITS values to the values of un-aged control specimens prepared with the same additive content. Hurley and Prowell (2005) used ITS results to check the rutting potential after application and the short- and long-term aging characterization of WMA mixtures [24].

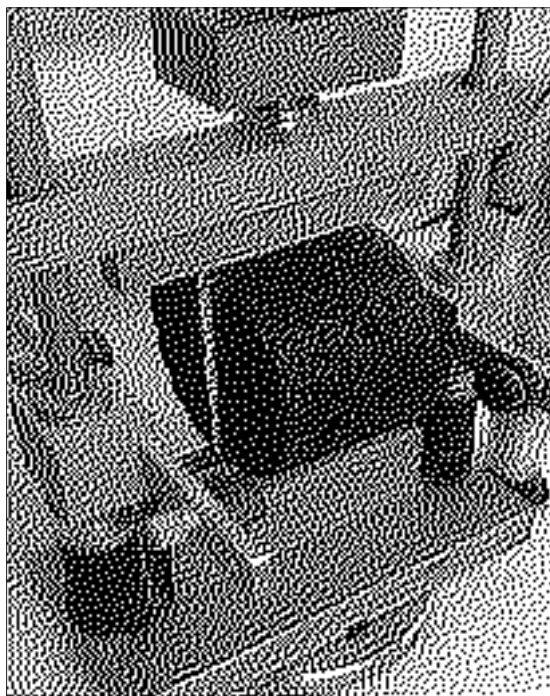


Figure 2 Specimen prepared for ITS test

The raw data recorded from the test device should be processed using the following Eq. (2) to obtain indirect tensile stresses:

$$S_t = \frac{2000 \times P}{\pi \times t \times D} \quad (2)$$

Where:

$S_t$  – Indirect tensile strength (ITS), [kPa]

$P$  – Maximum load, [N]

$t$  – Specimen height immediately before test, [mm]

$D$  – Specimen diameter, [mm]

Following the determination of ITS values, aging indices were calculated for non-rejuvenated and rejuvenated mixtures respectively as the ratio of ITS value of non-rejuvenated mixture over control mixture and the ratio of ITS value of rejuvenated mixture over control mixture. The results were then compared to each other.

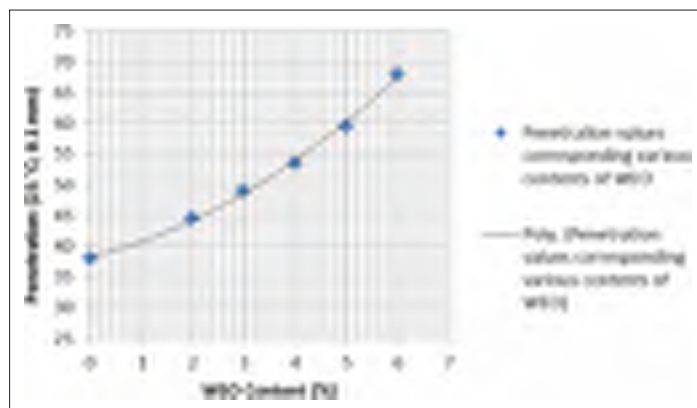
### 3 Results and Discussions

#### 3.1 Binder test results

Results for rejuvenated binder with optimum WEO content are presented in Table 8. WEO additive was capable of increasing penetration and also decreasing the softening point values both to the required specification limits. Fig 3. represents the penetration values for various contents of WEO. As aforementioned, the optimum WEO content was derived from this chart choosing the WEO content corresponding the same penetration value of the virgin binder. As seen on the Fig. 3, the penetration values track an increasing polynomial trend-line as WEO content increases. It is possible to gain a desired penetration by adding adequate content of WEO to RAP binder. Softening point should be controlled following the addition of WEO. Besides, considering viscosity values, it can be said that the workability of rejuvenated RAP mixtures improved significantly. Mixing and compaction of rejuvenated mixtures can be made with a regular effort. Softening point of rejuvenated binder was determined more than softening point of virgin binder. Although this value is a borderline value in terms of specifications, it is realised that rejuvenated binder will endure higher temperatures during hot seasons. The rejuvenated binder behaves similar to air-blown asphalts in this case. RTFO test results unveiled that the rejuvenated binder is more sensitive to short term aging than virgin binder. This can be attributed to volatilization of oily WEO during heating process of RTFO test. The test results after RTFO still remained within the specification limits. Overall the binder test results are matching with literature [15], [16].

**Table 8** Properties of rejuvenated RAP binder modified with optimum WEO content

Test	Specification	Results	Specification limits
Penetration (25 °C; 0.1 mm)	TS EN 1426	63	50–70
Softening point (°C)	TS EN 1427	54	46–54
Viscosity at (135 °C)-Pa.s	ASTM D4402	0.412	–
Viscosity at (165 °C)-Pa.s	ASTM D4402	0.087	–
Rolling Thin Film Oven (163 °C)	TS EN 12607-1		
Change of mass (%)		0.12	0.5 (max)
Retained penetration after RTFO (%)	TS EN 1426	53	50 (min)
Softening point rise after RTFO (°C)	TS EN 1427	6	7 (max)



**Figure 3** Penetration values corresponding various contents of WEO

### 3.2 Mixture test results

As mentioned before, the highest RAP contents were determined for mixture containing non-rejuvenated and rejuvenated RAP in order to compare the highest potential of RAP to be employed within a type I wearing course.

#### 3.2.1 Marshall stability and flow results

Volumetric analysis together with Marshall stability and flow values were base criteria in selection of maximum possible RAP content for both mixture involving non-rejuvenated and rejuvenated RAP. Results for air void contents, stabilities and flow rates are respectively presented in Fig. 4 to Fig. 6.

As can be seen in the Fig. 4, all mixtures containing rejuvenated RAP could meet volumetric criteria in terms of air voids since mixtures containing non-rejuvenated RAP fail to satisfy desired air voids content for mixtures containing more than 40% non-rejuvenated RAP. The reason that volumetric characteristic of rejuvenated RAP containing mixtures remained within the desired contents is attributed to lower viscosity values of rejuvenated RAP binder and hence improved workability. At standard mixing and compaction temperatures, it is more convenient to process rejuvenated RAP mixtures than non-rejuvenated RAP mixtures. Rejuvenation made compaction fully done by Marshall compactor with same number of blows for RAP mixtures. When Fig. 5 is analysed, it is seen that all stability values are over specification limit. This result is expected since the bitumen within RAP is considered as an aged binder and thus the mixtures containing RAP are stiffer than virgin bituminous mixtures hence these mixtures recorded high stabilities. In fact, the most concerned issue for RAP recycling technologies is considered as durability rather than stability. Therefore, volumetric characteristics and flow rates (somehow, as an indicator of flexibility) are more determinative for maximum possible RAP content than stability values.

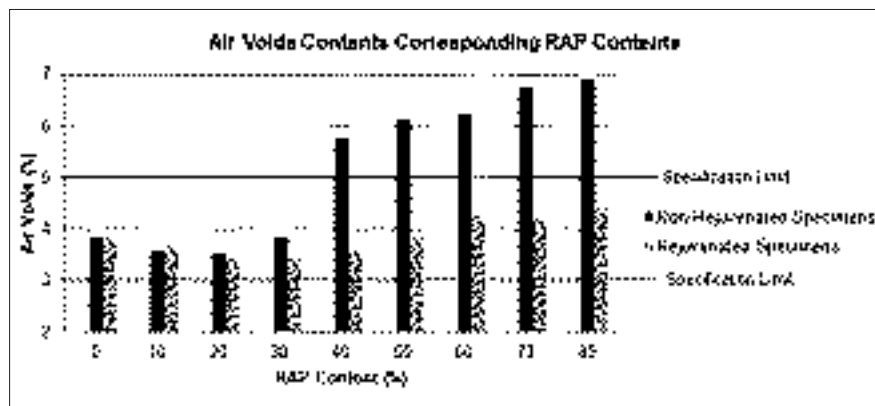


Figure 4 Air void contents

When evaluating flow rates, it is understood that this criteria is determinative for both non-rejuvenated and rejuvenated RAP involving mixtures. It is seen that, mixtures containing over 20% of non-rejuvenated RAP almost fail to meet the flow rate criteria since rejuvenated RAP mixtures flow well under destructive loads before fraction. Flow rates however, has been decisive in determination of maximum possible amount of rejuvenated RAP within type I wearing course. In this sense, 70% of rejuvenated (WEO modified) RAP can be employed within type I wearing course. It is obvious that the amount of maximum RAP which can be implemented without failing to meet all Turkish criteria increases substantially by rejuvenation process with WEO. Evidently, 50% more RAP can be employed by this method.



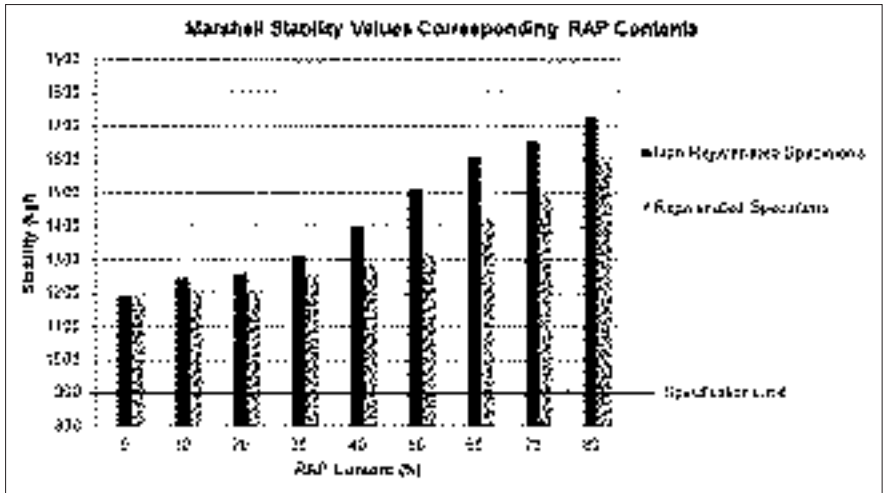


Figure 5 Marshall stability values

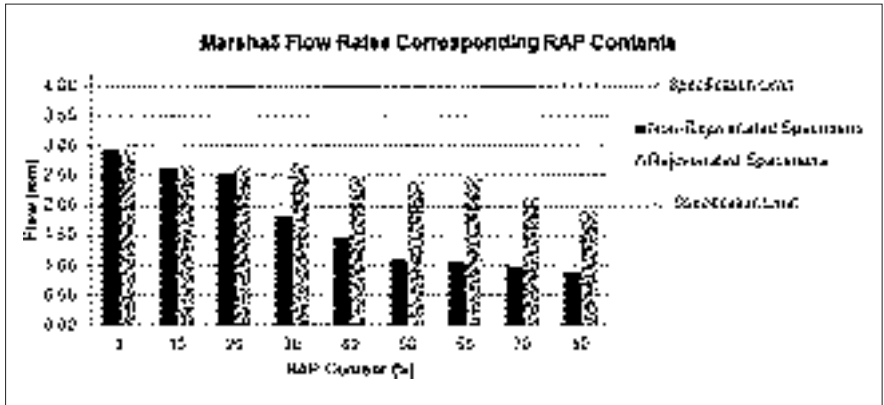


Figure 6 Marshall flow rates

### 3.2.2 Indirect tensile strength results and aging indices

As aforementioned, specimens were prepared with 70% RAP content (determined as the highest RAP content based on criteria) for both rejuvenated and non-rejuvenated mixtures and tested for ITS. Besides, the same test was conducted on specimens prepared with virgin mixtures with no RAP content as control specimens. The results are shown in Fig. 7.

ITS results provide the insight about mixture stiffness. It is seen that rejuvenated RAP recorded lower ITS than non-rejuvenated RAP. The use of WEO as a rejuvenator for employment of RAP inside HMA can soften the whole mixture and beside better workability, it will result in better flexibility as well. Aging indices have been calculated as 1.39 for non-rejuvenated mixtures and 1.16 for rejuvenated mixtures. The closer the aging index gets to 1, the less the mixture is aged and brittle. Therefore, it can be concluded that WEO modified RAP mixtures will be less brittle.



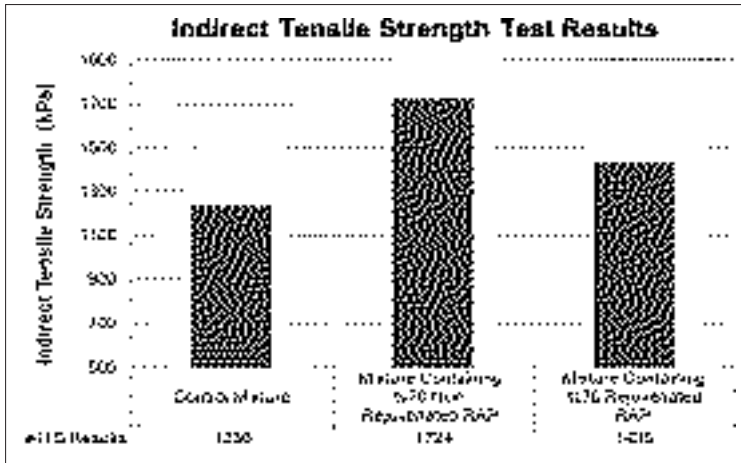


Figure 7 Marshall flow rates.

#### 4 Conclusions and recommendations

Efficient deployment of resources is critical in asphalt paving industry and real attention should be paid to this issue. Aggregate quarries and petroleum industry both consume natural resources to feed asphalt paving industry with raw materials. Sustainability should not come to just study subjects or be confined with economic issues but also it must become a social and institutional responsibility. Recycling is now possible with recent techniques and new technologies are introduced all along the time to industrial world. Reutilizing of aggregates and bitumen will save natural resources and costs to a large extent. In addition, recycling of RAP with WEO will also be in favour of waste management and disposal issues. WEO, as its name suggests is a waste material and should be recycled, reutilized in a proper industry or disposed.

Within the scope of this study, the influence of WEO on properties of RAP was investigated. It was found that, WEO as an oily additive contribute actively as an oily constituent taking the place of previously evaporated and/or separated oil constituents of aged RAP binder. The properties of RAP binder can be enhanced by use of WEO to fulfil specification requirements. Binder penetration and softening point values as well as viscosity of binder can be modified by optimum WEO content. Penetration value is determinant in determination of optimum rejuvenator content. For any kind of WEO available at the market, the selection process can be conducted in order to determine optimum content. In this study, 5.4% of WEO by weight of binder has been found adequate. It is recommended to perform supplementary tests in lights of Superpave standards and specifications. Rheological evaluation of rejuvenated binders can be more interpretive in terms of characterization of rejuvenated binder. Rejuvenated binder not only can fulfil desired properties, it is also capable of meeting after RTFO test requirements. It can be said that WEO is a substantial additive which is efficient in rejuvenation of aged RAP binder.

Implementing WEO as a rejuvenator makes it possible to involve high amounts of RAP within HMA wearing courses. By rejuvenation technology up to 70% of RAP can be utilized without undesirable effects within surface courses. Rejuvenated mixtures are convenient to process in terms of mixing and compaction. WEO helps compaction fully done at standard HMA application temperature ranges. Investigations present that rejuvenated RAP mixtures are less brittle and more durable than non-rejuvenated RAP mixtures. Aging index of rejuvenated mixes are improved compared to non-rejuvenated mixes. It is recommended to evaluate mechanical

properties of rejuvenated RAP mixtures in accordance with Superpave criteria. Mixtures should be prepared by means of a gyratory compactor and evaluated for volumetric analysis. Supplementary performance based experiments should be conducted. For RAP mixture tests, rutting and fatigue performance evaluation are recommended.

## Acknowledgements

This research has been carried out with the valuable contribution of Dokuz Eylul University, The Graduate School of Natural and Applied Sciences. Authors appreciate the help and contribution of Selfa Yapı, Tezcan Asfalt, Yazıcıoğlu Nakliyat. Special thanks to Mr. Ulaş Güven and Taner Zengin for their contribution in laboratory works.

## References

- [1] Asphalt Recycling and Reclaimin Association, Basic Asphalt Recycling Manual. U.S. Department of Transportation, 2001.
- [2] Hansen, K.R., Copeland, A.: “Annual Asphalt Pavement Industry Survey on Recycled Materials and Warm-Mix Asphalt Usage: 2009–2012.”
- [3] Sonmez, I., Topcu, A., Yildirim, S.A., Eren, B.K., Gunay, E., Kara, M., Kavakli, B.: “Recycling and reuse of old asphalt coatings in hot bituminous mixtures,” in 24th World Road Congress, 2011.
- [4] Tao, M., Mallick, R.B.: “Effects of warm-mix asphalt additives on workability and mechanical properties of reclaimed asphalt pavement material,” *Transp. Res. Rec. J. Transp. Res. Board*, vol. 2126, no. -1, pp. 151–160, 2009.
- [5] Fernández-Gómez, W.: “A review of asphalt and asphalt mixture aging,” *Ing. e Investig.*, vol. 33, no. 1, pp. 5–12, 2013.
- [6] Lesueur, D.: “The colloidal structure of bitumen: Consequences on the rheology and on the mechanisms of bitumen modification,” *Advances in Colloid and Interface Science*, vol. 145, no. 1–2, pp. 42–82, 2009.
- [7] Petersen, J.C.: “Chapter 14 Chemical Composition of Asphalt as Related to Asphalt Durability,” *Dev. Pet. Sci.*, vol. 40, no. PART B, pp. 363–399, 2000.
- [8] Dony, A., Colin, J., Bruneau, D., Drouadaine, I., Navaro, J.: “Reclaimed asphalt concretes with high recycling rates: Changes in reclaimed binder properties according to rejuvenating agent,” *Constr. Build. Mater.*, vol. 41, pp. 175–181, 2013.
- [9] Shen, J., Amirhanian, S., Aune Miller, J.: “Effects of rejuvenating agents on Superpave mixtures containing reclaimed asphalt pavement,” *J. Mater. Civ. Eng.*, vol. 19, no. 5, pp. 376–384, 2007.
- [10] Asli, H., Ahmadinia, E., Zargar, M., Karim, M.R.: “Investigation on physical properties of waste cooking oil – Rejuvenated bitumen binder,” *Constr. Build. Mater.*, vol. 37, pp. 398–405, Dec. 2012.
- [11] Yu, X., Zaumanis, M., dos Santos, S., Poulidakos, L.D.: “Rheological, microscopic, and chemical characterization of the rejuvenating effect on asphalt binders,” *Fuel*, vol. 135, pp. 162–171, 2014.
- [12] Chen, M., Xiao, F., Putman, B., Leng, B., Wu, S.: “High temperature properties of rejuvenating recovered binder with rejuvenator, waste cooking and cotton seed oils,” *Constr. Build. Mater.*, vol. 59, pp. 10–16, 2014.
- [13] Ongel, A., Hugener, M.: “Impact of rejuvenators on aging properties of bitumen,” *Constr. Build. Mater.*, vol. 94, pp. 467–474, Sep. 2015.
- [14] Nayak, P., Sahoo, U.C.: “A rheological study on aged binder rejuvenated with Pongamia oil and Composite castor oil,” *Int. J. Pavement Eng.*, pp. 1–13, Nov. 2015.
- [15] Zaumanis, M., Mallick, R.B., Poulidakos, L., Frank, R.: “Influence of six rejuvenators on the performance properties of Reclaimed Asphalt Pavement (RAP) binder and 100% recycled asphalt mixtures,” *Constr. Build. Mater.*, vol. 71, pp. 538–550, Nov. 2014.

- [16] Jia, X., Huang, B., Moore, J.A., Zhao, S.: "Influence of waste engine oil on asphalt mixtures containing reclaimed asphalt pavement," *J. Mater. Civ. Eng.*, p. 04015042, 2015.
- [17] Servas, V.P., Edler, A.C., Ferreira, M.A., Assen, E.J.: "An integrated approach for determining additive requirements in hot mix recycling. Sixth International Conference, Structural Design of Asphalt Pavements," *Publ. Michigan Univ. Ann Arbor*, 1987.
- [18] Shen, J., Ohne, Y.: "Determining rejuvenator content for recycling reclaimed asphalt pavement by SHRP binder specifications," *Int. J. Pavement Eng.*, vol. 3, no. 4, pp. 261–268, 2002.
- [19] Zaumanis, M., Mallick, R.B., Frank, R.: "Determining optimum rejuvenator dose for asphalt recycling based on Superpave performance grade specifications," *Constr. Build. Mater.*, vol. 69, pp. 155–166, 2014.
- [20] Anderson, R.M., Christensen, D.W., Bonaquist, R.: "Estimating the rutting potential of asphalt mixtures using Superpave gyratory compaction properties and indirect tensile strength," in *Association of Asphalt Paving Technologists Technical Sessions, 2003, Lexington, Kentucky, USA, 2003*, vol. 72.
- [21] Sengoz, B.: "The effect of asphalt film thickness on the aging and moisture susceptibility of hot mix asphalt," *Istanbul Technical University*, 2003.
- [22] Liang, R.Y., Lee, S.: "Short-term and long-term aging behavior of rubber modified asphalt paving mixture," *Transp. Res. Rec.*, no. 1530, 1996.
- [23] Topal, A., Sengoz, B.: "Effect of SBS polymer modified bitumen on the ageing properties of asphalt," *Proc. 4th Eurasphalt&Eurobitumen Congress Copenhagen, Denmark, 2008*.
- [24] Hurley, G.C., Prowell, B.D.: "Evaluation of Sasobit® for use in warm mix asphalt," *Auburn*, 2005.



## EVALUATION OF CHEMICAL FRACTIONS IN PAVING GRADE BITUMEN 50/70 AND EFFECTS ON RHEOLOGICAL PROPERTIES

Diana Simnofske, Konrad Mollenhauer  
*University of Kassel, Germany*

### Abstract

Generally, paving grade bitumen is characterized by mechanical properties at low, medium and high temperatures (breaking point Fraass, penetration and softening point R&B). However, the origin of the raw oil used for bitumen production has a significant effect on the chemical bitumen characteristics usually described by the asphaltene and maltene colloid model concept. Different chemical analysis methods were applied to differentiate the colloidal properties of the binders. In order to evaluate the potential effects on rheology, 14 bitumen 50/70 samples from different proveniences and producers were analyzed on physical, chemical and rheological properties. For the rheological characterization, complex shear modulus tests were conducted in a temperature range of 20 °C to 90 °C at different frequencies. The physical properties were determined by softening point ring and ball. Chemical groups of binders were characterized by thin layer chromatography (TLC/FID) to differentiate in asphaltenes, resins, aromatics and saturates (SARA-analysis) according to colloid model concept. Furthermore asphaltenes were separated into three fractions of different solubility by dissolution/precipitation procedure. This paper presents the differences between rheological, physical and chemical properties of several bitumen samples, which all represent the requirements on 50/70 according to European Standard EN 12591 and which are commonly applied in German asphalt industry. The paper discusses if the specification system based on conventional characteristics is sufficient for European road industry or if still significant differences in rheological and chemical properties are observed.

*Keywords: paving grade bitumen, rheology, SARA-analysis, asphaltenes, FTIR*

### 1 Introduction

Generally, paving grade bitumen is characterized by mechanical properties at low, medium and high temperatures (breaking point Fraass, penetration and softening point R&B) according to EN 12591 [1]. For evaluating the general applicability of additional/alternative properties for characterization, in Germany rheological properties are measured for experience since 2012 [2]. Softening point ring and ball and thermo-rheological characteristics of bituminous binders are directly associated with its chemical composition. They can simplistically be characterized with a colloidal model which is based on the theory that colloids with high polarity (asphaltenes) are peptized to micelles surrounded by a layer of resins in an oily phase with lower polarity, called maltenes [3]. At high temperatures, asphaltene can be fully dispersed in the maltene phase which results in viscous behavior and can be interpreted as Newton fluid. The higher the asphaltene content, a higher temperature is required to reach this non-elastic fluid characteristics which can be observed by an increased softening point ring and ball. On the other hand at lower temperature, elastic behavior of bitumen is caused by interaction between asphaltene micelles when asphaltene colloids become more complex

[4]. Chemical methods for separating bitumen into maltenes, asphaltenes and further in low soluble asphaltenes (lsA), medium soluble asphaltenes (msA) and high soluble asphaltenes (hsA) by dissolution/precipitation procedure as well as by SARA analysis for separating bitumen in asphaltenes, resins, aromatics and saturates are available test methods for evaluating the colloidal system [7, 12].

## 2 Experimental

### 2.1 Materials

In order to evaluate the relevance of chemical characteristics of the same type of paving grade bitumen, 14 bitumen 50/70 samples from different producers (as described by the first sample numbers 1 to 5) and production sites / raw oil source were analyzed.

### 2.2 Mechanical bitumen characteristics

The softening point ring and ball was measured according to the EN 1427 [5]. The rheological properties of bituminous binders were evaluated by Dynamic Shear Rheology (DSR), using plate-plate tests according to EN 14770 [6]. Cylindrical samples with a diameter of 25 mm and a height of 1 mm were tested. For temperatures between 30°C and 90 °C at frequency 1.59 Hz the shear moduli and phase angles were measured.

### 2.3 Chemical bitumen characteristics

The compositions of asphaltenes in terms of low, medium and high solubility are measured by a dissolution/precipitation procedure by Zenke [7] with three different solvent combinations of iso-octane and cyclohexane. The sum of these fractions results in total asphaltene content. The solvent defining asphaltenes in this test is Iso-Octane  $iC_8$ .

Four chemical fractions of different polarity were determined by thin layer chromatography (TLC/FID) according to IP 469 [12]. For the analysis 0.1 g of the bitumen sample was dissolved in 5 ml of dichloromethane. Fractions of saturates are evaluated by chromatographically separation in heptane, aromatics in toluene/heptane (80:20), resins in dichloromethane/methanol (95:5) and asphaltenes are not eluted. In this study the maltene phases consist of saturates, aromatics and resins. Note, that the resulting asphaltenes content is here defined by solubility in dichloromethane which results in different proportions compared to evaluation with  $iC_8$ . The test procedures are described in more detail in [8]

## 3 Results

### 3.1 Mechanical bitumen characteristics

The measured softening points are given in Figure 1. All results are within the limits (46°C to 54°C) for binders with penetration grade 50/70 according to EN 12591. Highest temperatures are evaluated for binder B1.1, B3.5, B2.1 and B4.1.

The results of complex shear modulus and phase angle tests at the frequency 1.59 Hz are plotted versus the temperature in Figure 2. Generally the shear moduli of the tested samples are within a comparatively small range for each tested temperature. However, at lower test temperatures < 60°C binder samples B1.1 and B3.4 indicate higher  $G^*$  values. For the phase angles, which represents viscous and elastic properties in bituminous binders a higher differentiation between the samples can be observed. Binders 3.3, 3.4 and 3.5 show lowest phase angles which indicates higher elastic and lower viscous deformation properties compared to the other binders. Continuous high phase angles are observed for binder B5.1 and B3.1.

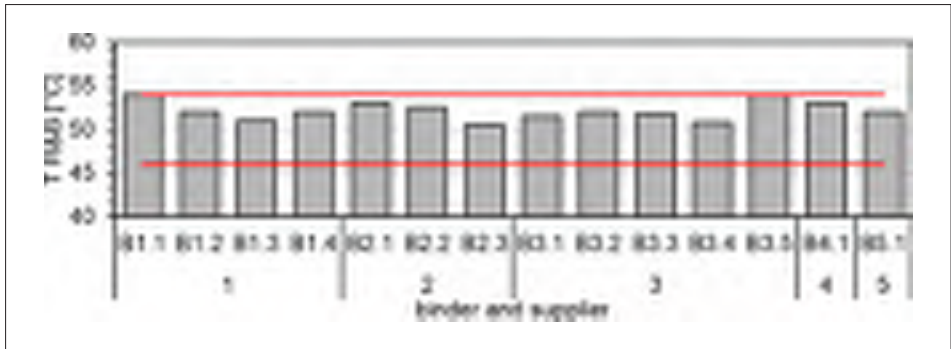


Figure 1 Results for  $T_{R\&B}$  for all 50/70 penetration bitumen

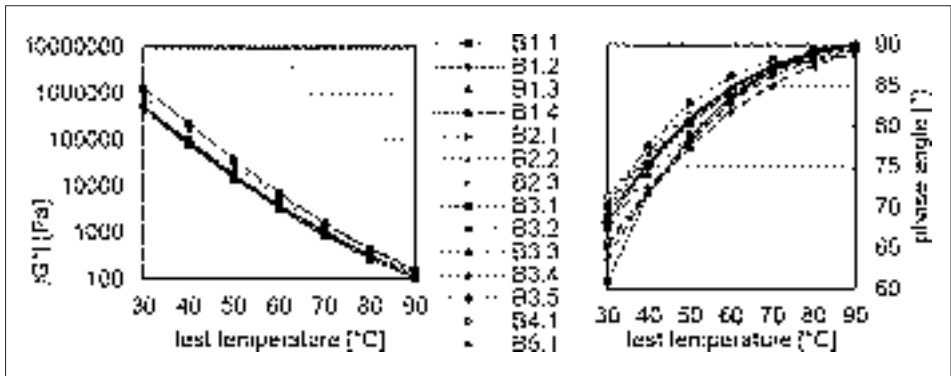


Figure 2 Complex modulus and phase angle versus temperature measured at 1,59 Hz

### 3.2 Chemical bitumen characteristics

Results of the precipitation experiments by Zenke are presented in Figure 3, showing the maltene content (as defined by soluble compounds in  $iC_8$ ) and the three asphaltene proportions.

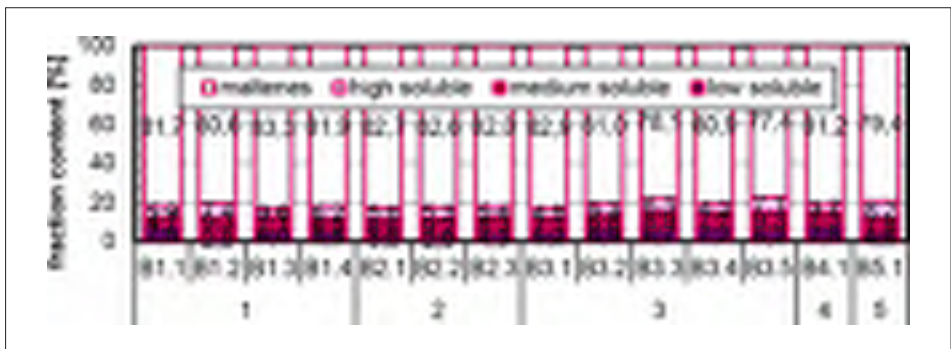


Figure 3 Content of low, medium, high soluble asphaltenes, total asphaltenes

To the resulting total asphaltene content vary between 16.7% (B1.3) and 22.6% (B3.5). Highest asphaltene contents of > 20% can be observed for B3.3, B3.4 and B5.1. The majority of sam-

ples indicate total asphaltene contents of between 17% to 19%. In most cases medium soluble asphaltenes could be evaluated as highest fraction of the three types of asphaltenes. Exceptions are B1.1, B3.2 and B4.1 with highest low soluble asphaltene content and B5.1 with highest content of high soluble asphaltenes and lowest content of low soluble asphaltenes. The proportions of the bitumen SARA fractions obtained from TLC/FID tests are plotted in Figure 4.

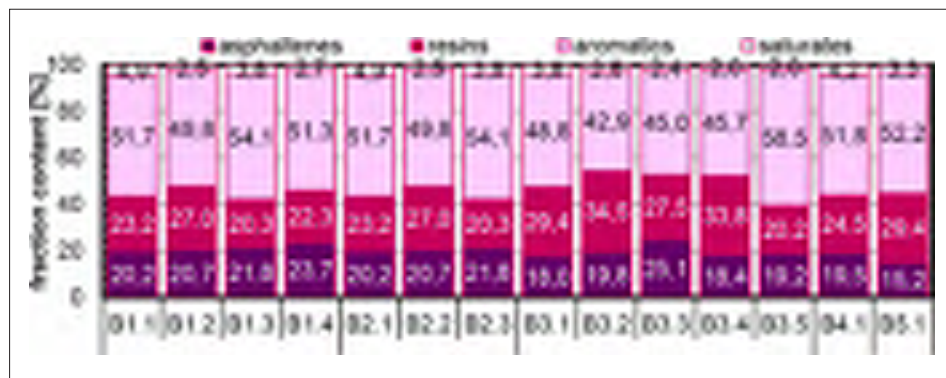


Figure 4 SARA components of binders 50/70

Saturates are the fraction with lowest and aromatics the fractions with highest content in all 50/70. The asphaltene content varies between 15.2% (B5.1) to 25.1% (B3.3). In most cases resin contents in bitumen sample are higher than asphaltene content.

## 4 Discussion

For discussing the effects of chemical characteristics on physical and rheological properties, linear correlation analysis is conducted. For assessment of an existing link between two compared properties, these are plotted one versus the other and the coefficient of determination ( $R^2$ ) is calculated. The nearer  $R^2$  increases the value 1, the better is the correlation between the two properties.

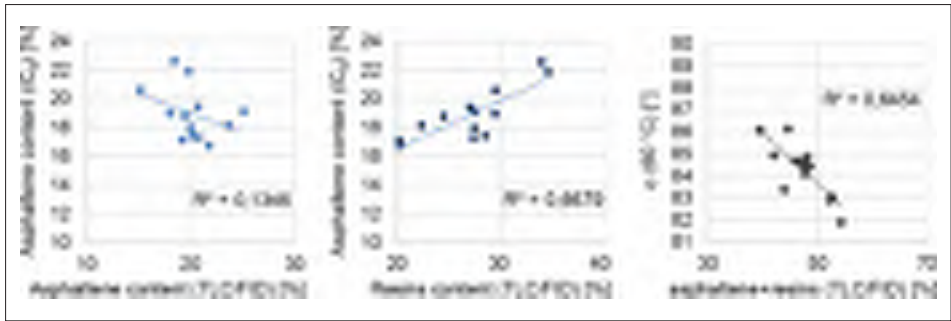
In the following sections some found correlations for selected pairs of parameters are discussed. Further, it was found, that the properties of binder sample 1.1 doesn't meet the found correlations. This binder 50/70 was especially specified as binder for preparing foamed bitumen. Therefore, the results of this binder sample are not included in the following evaluation. Based on the previous rheological results better coefficient of determination could be determined without binder 1.1 with special foam bitumen characteristics.

Surprisingly, no correlation between the two asphaltene contents evaluated by the TLC/FID and dissolution/precipitation method could be identified, see Figure 5 (left). For example, binder 5.1 shows the lowest asphaltene content in SARA analyse (dichloromethane) while it has one of the highest asphaltene contents in the other method, where asphaltenes are defined by Iso-Octane. This result shows the importance of clear defining chemical characteristics and careful evaluation of chemical bitumen compounds.

However, a feasible correlation is found for total asphaltene content ( $iC_p$ ) and resins content by SARA analyse ( $R^2 = 0.66$ ). With increasing resins content, total asphaltene content by Zenke rises, see Figure 5 (left).

Table 2 shows the coefficients of determination for selected chemical fractions and the results of DSR tests (shear modulus and phase angle). As an example the correlation between phase angle and content of asphaltenes and resins is shown in Figure 5 (right).





**Figure 5** Examples for correlation between chemical and rheological parameters: left:  $iC_8$ -asphaltene content by dissolution versus TLC test; middle:  $iC_8$ -asphaltene content by dissolution versus resins content by TLC test; right: Phase angle (DSR) versus content of asphaltenes and resins by TLC test

**Table 1** Selected results for coefficient of determination

Rheolog. Property @ 1,59 Hz	Temperature [°C]	asphaltene contents by dissolution test		content of SARA compounds by TLC/FID test	
		total asphaltenes	low and medium soluble asphaltenes	aromatics	Asphaltenes and Resins
Complex shear modulus $G^*$	30	0,06	0,07	0,03	0,07
	40	0,10	0,18	0,15	0,21
	50	0,16	0,28	0,36	0,44
	60	0,28	0,37	0,54	0,64
	70	0,43	0,43	0,65	0,77
	80	0,45	0,40	0,68	0,80
	90	0,54	0,41	0,67	0,80
Phase angle $\phi$ [°]	30	0,33	0,72	0,28	0,37
	40	0,39	0,81	0,46	0,53
	50	0,37	0,73	0,56	0,61
	60	0,34	0,64	0,61	0,65
	70	0,30	0,60	0,58	0,62
	80	0,49	0,70	0,60	0,67
	90	0,59	0,57	0,45	0,55
$T_{R\&B}$		0,16	0,04	0,05	0,04

Complex shear modulus is mostly influenced by asphaltenes and combination of low soluble and medium soluble asphaltene content as identified in dissolution test especially at higher test temperatures. For SARA analyse feasible correlation for content of aromatics and the combination of asphaltenes and resins could be determined. With increasing temperature coefficient of determination increase for all results, too.

Phase angle is also influenced by same chemical fractions as complex shear modulus. Phase angle is continuous influenced by the combination of the content of low and medium soluble asphaltenes as well as contents of aromatics and combination of asphaltenes and resins at all test temperatures. For the softening point ring and ball only low coefficients of correlations are identified. This can be explained by the small range of softening points identified in the binder samples of 51 °C to 54 °C.



## 5 Interpretation

In this study no relationship between the asphaltene contents evaluated by the two different test procedures could be determined. The general magnitude of asphaltene contents identified by the two test procedure are similar (dissolution test: 17% to 22.5%; TLC/FID tests: 15% to 25%). It is not possible to differentiate a high asphaltene content by Zenke to a high asphaltene content by SARA analyse. Reasons for the non-existing correlation can be explained by the different evaluation technique as well as the diverting solvent used [9, 10]. The identified relationship between the total asphaltene content in dissolution test and the resins content as identified in TLC/FID tests however shows that comparable results can be obtained.

Besides the identification of the binder optimised for foamed bitumen additional anomalies could be found for binder sample B5.1 with regard to highest phase angle which results in lowest elastic properties compared to the other 50/70. In [11] elastic rheological properties are determined by asphaltene content. In this case B5.1 is a binder with one of the highest asphaltene content (dissolution experiment) by Zenke. On the hand B5.1 show one of lowest asphaltene content by SARA analyse. It seems that SARA analyse is more suitable to describe rheological properties in a chemical way. By combining the single asphaltene fractions by Zenke, another chemical profile for bituminous binders is given. Figure 6 shows one of lowest results for the combination of low and medium soluble asphaltene (IsA+msA) content for binder B5.1. These good correlation can be seen as well as in coefficient of determination.

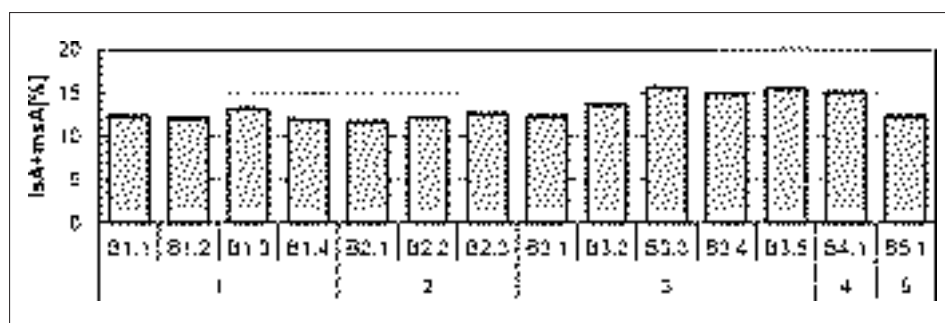
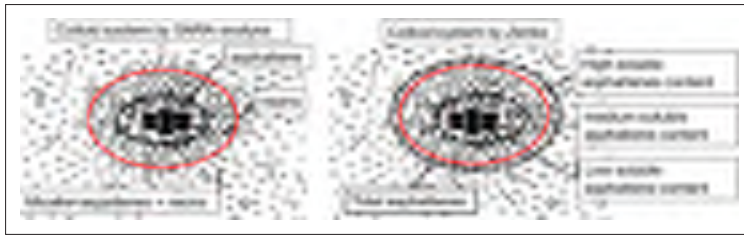


Figure 6 Content of low and medium solvable asphaltenes (dissolution test)

Despite the low variation of rheological properties between the binder samples of the same type 50/70 clear correlations could be identified to individual chemical properties. Based on colloid model of micelles built of asphaltenes and surrounding resins as described in [4]. By increasing temperature the correlation of the four selected fractions to complex shear modulus increases, especially for results of TLC/FID tests. At low temperatures, asphaltenes are covered by agglomerated resins and therefore, the pure asphaltene content doesn't affect the rheological properties. However with increasing temperatures resins (and high-soluble asphaltenes) will melt and be form a part of the maltene phase. In this state, the content of the still solid asphaltenes affects the rheological properties significantly by stiffening the maltene phase showing increased shear modulus and reduced phase angles. The shear modulus increases if the content of asphaltenes and resins increase and content of aromatics decrease.

Results of correlation according to asphaltene dissolution/precipitation tests show that high soluble asphaltene are not important to explain rheological properties of 50/70 but the sum of low and medium asphaltenes. This is an indication that the high soluble asphaltenes will shift to maltene phase with increasing temperature. The general concept idea of micelle structure based on SARA compounds [4] can therefore be adopted for the concept of asphaltene separation according different solubility, compare Figure 7.



**Figure 7** Colloid model according to SARA fractions [4] and interpretation of effect of asphaltenes as identified by dissolution/precipitation tests

## 6 Conclusion

The following conclusions can be drawn from the results of the presented investigation:

- Chemical properties depends on their methods to determine the chemical fractions.
- Even straight bitumen of the same kind (here: 50/70) shows variations in chemical structures which can be explained by individual refinery process and raw oil provenience.
- These variations affects the rheological properties of the bitumens despite the same range of conventional characteristics.
- Rheological characteristic could not be described by single chemical fraction but significantly by combinations of bitumen fractions.

## References

- [1] EN 12591. Bitumen and bituminous binders – Specifications for paving grade bitumens, 2009
- [2] Allgemeines Rundschreiben Straßenbau – ARS Nr. 11/2012. Bundesministerium Verkehr, Bau und Stadtentwicklung, 2012
- [3] Asphaltic Bitumen As Colloid System. Pfeiffer, J. Ph. and Saal, R. N. J., Laboratorium N. V. de Bataafsche Petroleum Maatschappij, 1939.
- [4] Neumann, H.-J., Rahimian, I., Paczynska-Lahme, B.: Zur Strukturalterung von Bitumen. Bitumen 2, pp. 54-56, 1992
- [5] EN 1427. Bitumen and bituminous binders – Determination of the softening point – Ring and Ball method, 2007
- [6] EN 14770. Bitumen and bituminous binders – Determination of complex shear modulus and phase angle using a Dynamic Shear Rheometer (DSR)
- [7] Zenke, G.: Zum Löseverhalten von Asphaltene: Anwendung von Löslichkeitsparameter-Konzepten auf Kolloidfraktionen schwerer Erdölprodukte. Dissertation, Clausthal-Zellerfeld, 1989
- [8] Simnofske, D., Mollenhauer, K., Butz, T., Oelkers, C.: Aging characteristics of warm mix asphalt binders modified with F-T wax – Benefits for efficient application and adequate performance. International Journal of Advance Research in Science and Engineering, pp. 138-156, 2015
- [9] Teugels, W.: Analysis of the generic composition. Appraisal of the iatrosan method. International Symposium Chemistry of Bitumens. Rom, 1991
- [10] Lesueur, D.: The Colloidal Structure of Bitumen: Consequence on the Rheology and on the Mechanisms of Bitumen Modification, 2009
- [11] Radenberg, M.: Einfluss der chemischen, rheologischen und physikalischen Grundeigenschaften von Straßenbaubitumen auf das Adhäsionsverhalten unterschiedlicher Gesteinskörnungen. Schlussbericht AiF Forschungsprojekt. Ruhr Universität Bochum, Bochum, 2014
- [12] IP test method. IP 469. Determination of saturated, aromatic and polar compounds in petroleum products by thin layer chromatography and flame ionization detection. 2001





## ROLLED COMPACTED CONCRETE PAVEMENTS

László Énekes, Zsolt Bencze, László Gáspár

*KTI Institute for Transport Sciences Non-Profit Ltd., Hungary*

### Abstract

Roller-Compacted Concrete (RCC) road pavement is well-spread in the USA and in several European countries due to its strength, density and durability, economic advantages and high construction speed. Its name comes from the heavy steel drum rollers which compact the concrete into final form. The RCC consists of the same ingredients as conventional concrete does, but it has a higher percentage of fine aggregates and is stiff enough to remain stable under compaction having sufficient water for distributing the paste without segregation. After having studied different previous research works and the documents of completed RCC constructions, a mixture was planned following the main principles from the examples taking the available components into consideration. In KTI laboratory, numerous test cubes, cylinders and beams were made for testing the strength properties, freeze-thaw durability, water permeability, abrasion wear and air void characteristics for hardened concrete. The results obtained proved that RCC can have the same properties (quality) as conventional concrete has. Using the available mixtures, a test (trial) section was planned, and organized in order to evaluate the quality of placement (laying) and compaction operations, and to fine-tune eventually the mixture composition, and to bore core samples to perform testing on the constructed RCC. It has been shown that RCC with basic ingredients and proper recipe (mixture proportions) can be made with similar strength and durability as conventional concrete, but unlike conventional pavements, RCC pavements can be constructed without forms, dowels or reinforcing steel. This technology gives a favourable economical alternative for pavements carrying heavy loads in low-speed areas such as industrial plant access roads, shipping yards, posts, loading docks, large commercial parking lots, and it can also be used as base course for semi-rigid pavement structures. The Hungarian trial section built is still in good shape after 2-year heavy traffic load.

*Keywords: concrete pavements, roller compacted concrete, trial sections, concrete mix design, concrete pavement construction*

### 1 Introduction

RCC (Roller Compacted Concrete) road pavements have been built in several countries all over the world, primarily for slow moving heavy traffic. The main feature of its technology is the compaction of laid fresh cement concrete mixture using vibratory heavy steel-drum compactors and pneumatic-tyre rollers. The use of the construction technology in Hungary was preceded by the research works and tests to be briefly presented. KTI Non-Profit Ltd., Budapest performed – on behalf of CEMEX Hungária Ltd. – literature survey, research, mixture design on RCC, besides prepared the construction of a trial section and monitored it [1].

## 2 Some related literature sources

The main potential advantages of RCC roads compared to other road types are the smaller carbon footprint (less environmental impact), singular material construction (in-situ materials) and faster construction time (faster compacting than with finisher). RCC techniques are the perfect solution for low-cost cement concrete road or dam constructions [2, 7]. The use of RCC in public and private applications has been increasing steadily in various countries all over the world in recent years particularly in the construction of low-volume roads and parking lots [2]. RCC pavements are strong, dense, and durable. These characteristics, combined with construction speed and economy, make RCC pavements an excellent alternative for parking and storage areas; port, intermodal, and military facilities; highway shoulders; streets; and highways. RCC can also be used in composite systems as base material [3]. In-situ materials have become more and more relevant in construction nowadays [4]. Some guideline and specification were developed for roller compacted concrete (RCC) as an exposed RCC pavement surface, that may or may not be diamond ground for smoothness and/or texture [5]. Some studies related to secondary materials in RCC provided favourable results from the point of view of compaction and long-term performance. Using natural pozzolan or fly ash in massive concrete dam construction, it is possible to achieve a temperature rise reduction without any undesirable effects such as bleeding, tendency to segregate and tendency to increase permeability [6].

## 3 RCC mix design

Roller compacted concrete mixture has the same ingredients as traditional concrete mix has; just the ratios of fractions are different. Its construction cost practically does not differ from that of conventional concrete; the extra costs of more fine fractions and eventual additional additives are compensated by the cost saving coming from reduced cement need.

### 3.1 Aggregate

Aggregate grading of RCC-mixtures differs from that of traditional concretes because partly RCC mixture will be denser under paver, steel and pneumatic-tyre rollers, partly fine fraction ratio should be increased for the total saturation of concrete mixture. Figure 1 presents the selected aggregate grading compared to the upper and lower bounds coming from averaging the relevant Hungarian and some foreign boundaries.

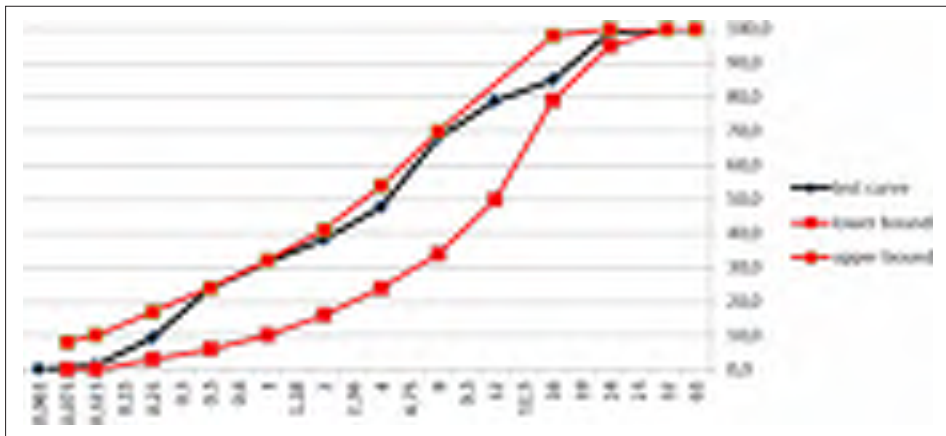


Figure 1 The selected aggregate grading compared to boundaries obtained by averaging boundaries in Hungarian and some foreign specifications

## 3.2 Binders

RCC mixtures can be produced using any cement type meeting specification requirements [8] in Hungary. Selection of optimal cement type is influenced by environmental effects (sulphate resistance, resistance to thawing salts, abrasion resistance). It is advised to use cement types with limited hydration heat since the mixture uses low water content, and proper hydration does need sufficient water.

## 3.3 Water

Water needed for hydration is originated partly from the water content of aggregate, partly from the water added at mixing plant. Water used should meet the quality requirements of relevant standard [9]. RCC technique needs the highest possible density of concrete; that is why the optimal water content of mixture should be determined in accordance of the relevant standard [10].

## 3.4 Admixtures

Also the admixtures used for traditional concrete mixture (plasticizers, set re-tarders, accelerators, air entrainers, etc.) can be applied. Due to the limited water amount in RCC mixture, dosages of various admixtures can be multiple of the common ones. Set retarder can be needed if laying in 45-60 minutes after mixing is questionable, especially in warm time. Based on foreign experiences, two recipes were selected for the test sections with different cement contents.

# 4 Construction rules

## 4.1 Subgrade

Subgrade density should be min. 95% of Proctor density. For avoiding bearing capacity loss due to eventual subgrade wetting, a granular capping layer is recommended.

## 4.2 Concrete mixing

Batch or continuous concrete mixing plants can be used. Batch plants are appropriate for small projects when mixture is transported by covered trucks to the site. Mixer has to be fully emptied after each mixing cycle before mixing next batch. Continuous mixing for big projects allows the production of cement concrete mixture of constant quality. Properly homogenous concrete mixture of needed quantity and quality should arrive to the paver. Because of the dryness of RCC mixtures, the appropriate mixing at batch type production necessitates more energy reducing mixing plant capacity. The same dosage tolerances are to be used for RCC as for traditional concrete; however, it is important here to apply moisture meter for avoiding segregation.

## 4.3 Laboratory tests

The laboratory tests in relevant Road Technical Directives [11, 12] and in foreign literature were carried out. For fresh concrete, aggregate moisture content, compaction [13] and water/cement ratio should be measured, and maximal wet density [14] designed. For hardened concrete, compressive strength [15], splitting tensile strength [16], density [17], distance factor [18], frost resistance [19], water permeability [20] and abrasion resistance [21] were tested.

#### 4.4 Transportation

Generally, trucks with dump bodies are used. Concrete mixture has to be poured in 60 minutes since the mixtures with low water/cement ratio harden much quicker than the more flexible ones. Number and capacity of trucks to be applied have to ensure the continuous laying of concrete mixture. The mixture should be covered during transportation to protect it from evaporation or raining. Mixture has to be loaded directly from lorry to the finisher. For allowing to the evaporation loss during transportation, slightly increased water content can be selected

#### 4.5 Laying

RCC is usually laid by an asphalt paver the edge compactors of which compact the mixture, and so, rollers can move on a pre-compacted surface. Precompaction should reach 85% of maximum wet density. Paver could lay min. 1.5 times output capacity of mixing plant. In order to avoid the segregation during concrete pouring, paver should not be emptied completely during laying, spreading screws are to be covered continuously by mixture. Paver speed has to be selected to ensure the continuous paving to avoid surface unevenness.

#### 4.6 Compaction

Some general rules of RCC compaction:

- Compaction has to be commenced immediately after concrete pouring. Primary compaction should be performed using 10 ton double drum vibratory roller. Secondary compaction is to be done by static roller passes, while the even surface can be attained using pneumatic-tire rollers. In tight places where space is limited for heavy rollers, small plate compactor or rammer (jumping jack compactor) can be applied. Compaction has to be completed in 15 minutes after laying, and 60 minutes after the end of concrete mixing.
- Ideally, no water enters from below on the surface of freshly compacted RCC course. The compaction rate of rolled compacted concrete pavement can be readily assessed by scrutinizing concrete mixture behaviour under static roller passes. Uniform deformation under compaction proves appropriate concrete consistency. If concrete is too wet for compaction, layer surface becomes pasty and shining after rolling, and it behaves elastically, even under pedestrian traffic. If concrete is too dry, surface is granular and dusty, or even cracked. In the latter cases, water content of the mixture is to be changed, grading to be checked or weighing balance calibrated.
- Freshly laid concrete layers can be compacted relatively quickly and easily, however, some special rules are to be followed. Compaction rules are rather similar to those of hot laid asphalt layers. In both cases, the most important rules are to use continuously low (about 3 km/h) rolling speed, to change directions just gradually, and to accelerate after changing directions also gradually. No turning is allowed during roller passes. Changing rolling lanes, starting new lane or turning have to be done just at the back, on the already compacted and hardened pavement section.
- In case of RCC-layers with 151-250 mm thickness, the needed 98% density can be reached by 4-6 passes of a 10 ton vibrating compactor. Over-compaction can reduce the density of upper layer or edges can crack.

#### 4.7 Jointing

The joint types used are: tight, contraction and expansion joints. The planned tight joint is built between a new cement concrete layer and an "old" concrete pavement. However, RCC pavements' shrinkage, due to their low water contents, is just minimal, some cracking can be

developed. These cracks can be fully avoided if contraction joints are formed. It is suggested to saw pavements to a depth of one-quarter of the slab thickness at 6-18 m intervals. No sealing is needed for joints below 6 mm width. As for traditional concrete pavements, expansion joints should be placed to allow movement of the RCC pavement without damaging adjacent pavements, inter-secting streets or other fixed objects (buildings, public utilities shaft, etc.).

#### **4.8 Site tests**

At the RCC construction site, pavement compaction [13], as well as density and water content [22] are to be controlled. The aim of RCC compaction test is identical with that of consistency test for conventional concrete pavements. The test results inform about if the mixture can still pore after transport, and it can be compacted appropriately. The test results of pavement density and water content after laying point towards the attained percentage of maximal laboratory dry density which was obtained using the Proctor test.

#### **4.9 Curing and protection**

Since the water content of RCC is very low, and evaporation and hydration heat quickly reduce further its water content; if water is not retrieved, shrinkage cracking and/or lower strength could be caused. That is why curing should be started just after the completion of pavement compaction; aftercare has to be done for at least 7 days. Curing can be performed using watering-cart or fixed sprinkler.

### **5 Field trial**

#### **5.1 Principles of a field trial**

Before an RCC project, a field trial is strongly advised to demonstrate the suitability of the mix recipe, design, paving machinery, curing and joint forming. A trial PCC pavement should be constructed on dense and strong subgrade using the construction technique of the planned project. The dimensions of the trial area would be sufficient for supplying the following information types:

- Subgrade quality (grading, density, moisture content, etc.);
- Quality parameters of RCC ingredients, mixture and pavement, compared to relevant specification requirements;
- Suitability of mixing plant to produce continuously homogeneous RCC mixture and to feed basic materials accurately;
- Suitability of mix composition (recipe) for fulfilling relevant requirements;
- Quality of laying and compaction (compaction plan, number of passes);
- Shaping of construction lanes (timing, layout);
- Assessment of pavement surface features (texture, homogeneity, etc.);
- Testing concrete cube specimens made during field trial, comparison of their strength values with relevant requirements of type test.

Coming from the site tests and laying experiences results of field trial, originally planned technology can be modified.

#### **5.2 Trial sections**

##### **5.2.1 Some features of trial sections**

In the research work mentioned in section 1 [1], various recipes were designed in order to select the most suitable one for the planned RCC trial section on the access road of gravel pit



in Bugyi. The loading of the two 100 m-long sections are radically different depending upon whether the sections are used by loaded vehicles or empty ones. KTI-institute prepared a Technological Instruction and a Sampling and Qualification Plan for the field trial, it had technical surveillance, besides carried out fresh concrete and tested cored samples taken from the pavement. The degree of compaction of the very well-compacted subgrade has reached 100% compared to Proctor density during the several-year intensive truck loading. The Young's soil modulus measured by plate-bearing test amounted to a rather high (129.9 MP) value. That is why the trial section was designed without capping layer, just 50 mm 0/4 chippings were laid below the roller compacted concrete pavement for levelling and ensuring the planned cross fall. On the trial section with lower traffic size, RCC pavement was 150 mm thick, while its thickness on the relatively highly-trafficked section amounted to 200 mm. 50-50% of both sections were built using two different recipes for a later com-parison of their performances.

### 5.2.2 Some test results obtained on trial sections

Table 1 shows the main strength results of cement concrete mixtures with the same aggregate grading and different cement content.

**Table 1** Strength values of concrete mixes using two different recipes

	Recipe I						Recipe II					
	28 days	28 days	28 days	28 days	28 days	28 days	28 days	28 days	28 days	28 days	28 days	
Compressive strength (MPa)	30.0	30.0	30.0	30.0	30.0	30.0	30.0	30.0	30.0	30.0	30.0	
Splitting tensile strength (MPa)	4.0	4.0	4.0	4.0	4.0	4.0	4.0	4.0	4.0	4.0	4.0	
Flexure strength (MPa)	5.0	5.0	5.0	5.0	5.0	5.0	5.0	5.0	5.0	5.0	5.0	
Modulus of elasticity (GPa)	28.0	28.0	28.0	28.0	28.0	28.0	28.0	28.0	28.0	28.0	28.0	
Shrinkage (%)	0.15	0.15	0.15	0.15	0.15	0.15	0.15	0.15	0.15	0.15	0.15	

Before the field trial, among others, the Proctor-tests of the aggregates of the two mixtures were carried out, with the following results:  $w_{opt} = 4,7\%$ ;  $\rho_{dmax} = 2,39 \text{ Mg/m}^3$ ;  $w_{opt} = 4,7\%$ ;  $\rho_{dmax} = 2,37 \text{ Mg/m}^3$ . The site quality control data of RCC were in the following ranges: water content between 4.9 and 5.8%, dry density between 2.30 and 2.37 g/cm<sup>3</sup>, wet density between 2.43 and 2.50 g/cm<sup>3</sup>; degree of compaction between 96 and 100%.

## 6 Some concluding remarks

In a lot of countries, Roller Compacted Concrete pavements have proved to be an efficient and environmentally-friendly pavement type, especially for slow heavy traffic. Research works and laboratory test series carried out in KTI-laboratory also provided favourable results that were further validated by the good performance of trial section constructed. The legislation of this perspective pavement technology in Hungary is expected soon.

## Acknowledgement

The authors would like to acknowledge the financial support of CEMEX Hungária Ltd. as a major precondition for the RCC research and investigation, the topic of present conference paper.

## References

- [1] Énekes, L.: Research on and design of Roller Com-pacted Concrete (RCC) pavements. Research report No. 2161-001-1-4 of KTI Non-Profit Ltd., 110 p., 2015 (in Hungarian)
- [2] Pittman, D.W., Anderton, G.L.: The use of roller-compacted concrete pavements in the United States. Presentation at the Sixth International Conference on Maintenance and Rehabilitation of Pavements and Technological Control (MAIRE PAV 6), Torino, Italy, 2009.
- [3] Harrington, D., Abdo, F., Adaska, W., Hazaree, C.: Guide for Roller-Com-pacted Concrete Pavements. National Concrete Pavement Technology Center, 2010.
- [4] Shin, K-J., Carboneau, N.: The Indiana Local Technical Assistance Prog-ram Roller Compacted Concrete Pavement Manual for Local Government Agencies. Purdue University School of Civil Engineering, 2010.
- [5] ACPA Guide Specification: Roller-Compacted Concrete Pavements as Exposed / Bare Surface, 2013.
- [6] Vahedifard, F., et al.: Assessing the effects of supplementary cementitious materials on the performance of low-cement roller compacted concrete pavement; Construction and Building Materials 24 Elsevier, pp. 2528-2535, 2010.
- [7] Dolen, T.P.: Design and Construction Considerations for Hydraulic Struc-tures, Technical Service Center, Denver, Colorado, 177 p., 2005.
- [8] MSZ EN 197-1:2011 Cement Part 1: Composition, specification and con-formity criteria for common cements (in Hungarian)
- [9] MSZ EN 1008:2003 Mixing water for concrete –Specification for sampling, testing and assessing the suitability of water, including water recovered from processes in the concrete industry, as mixing water for concrete (in Hungarian)
- [10] MSZ EN 13286-1:2003 Unbound and hydraulically bound mixtures. Part 1. Test methods laboratory reference density and water content. Introduction, general requirements and sampling (in Hungarian)
- [11] e-UT 06.03.31 (ÚT 2-3.201:2006) Construction of Concrete Pavements. Specifications, Requirements (in Hungarian)
- [12] e-UT 06.03.51 (ÚT 2-3.206:2007) Unbound and Hydraulically Bound Base Courses. Construction Requirements (in Hungarian)
- [13] MSZ EN 12350-4:2009 Testing fresh concrete – Part 4: Degree of com-pactibility (in Hungarian)
- [14] MSZ EN 13286-50:2005 Unbound and hydraulically bound mixtures. Part 50: Method for the manufacture of test specimens of hydraulically bound mixtures using Proctor equipment of vibrating table compaction (in Hungarian)
- [15] MSZ EN 12390-3:2002 Testing hardened concrete Part 3: Compressive strength of test specimens (in Hungarian)
- [16] MSZ EN 12390-6:2010 Testing hardened concrete Part 6: Tensile splitting strength of test specimens (in Hungarian)
- [17] MSZ EN 12390-7:2009 Testing hardened concrete Part 7: Density of hardened concrete (in Hungarian)
- [18] MSZ EN 480-11:2006 Admixtures for concrete, mortar and grout. Test methods Part 11: Determination of air void characteristics in hardened concrete (in Hungarian)
- [19] MSZ 4798-1:2004 Concrete Part 1: Specification, performance, produc-tion, conformity and rules of application of MSZ EN 206-1 in Hungary (in Hungarian)
- [20] MSZ EN 12390-8:2001 Testing hardened concrete Part 8: Depth of penetration of water under pressure (in Hungarian)
- [21] MSZ EN 18290-1:1981 Testing surface properties of construction rock materials. Polishing test of sample masses (in Hungarian)
- [22] e-UT 09.02.11 (ÚT 2-3.103:1998) Radiometric compaction measurement. Determination of water content and density of subgrades, unbound and hydraulically bound road bases (in Hungarian)



### 3 TRANSPORT GEOTECHNICS





## QUANTITATIVE LANDSLIDE SUSCEPTIBILITY AND HAZARD ANALYSIS FOR EARTHWORKS ON TRANSPORT NETWORKS

Karlo Martinović<sup>1,2</sup>, Kenneth Gavin<sup>2,3</sup>, Cormac Reale<sup>1</sup>

<sup>1</sup> *University College Dublin, School of Civil Engineering, Ireland*

<sup>2</sup> *Gavin & Doherty Geosolutions Ltd., Ireland*

<sup>3</sup> *TU Delft, Faculty of Civil Engineering and Geosciences, Netherlands*

### Abstract

Earthworks such as cuttings and embankments account form a major part of the entire transport network infrastructure. Large parts of that infrastructure in Europe are susceptible to a range of geohazards, landslides being the most prevalent. These landslides frequently result in direct damage to assets, deaths and injuries, while indirectly also leading to traffic disruptions. There is a need therefore to identify critical assets where remediation efforts should be prioritised in order to prevent such events from occurring. Current state of the art practice involves using qualitative risk matrices, where the hazard and consequence components are determined through subjective visual survey observations.

Landslide hazard analysis determines the spatial (susceptibility) and temporal probability of landslides of a certain intensity occurring over an observed area. A number of quantitative methods for landslide hazard and risk assessment have been developed recently, generally these methods are considered more effective due to their reduced subjectivity and their consideration of additional factors. A number of studies outline the application of these methods to natural terrain, but to date these methods have not been developed for transport network earthworks. This study presents and compares the results of two landslide susceptibility analysis approaches for cuttings and embankments on a section of Irish Rail network. The first, “geotechnical” approach uses probabilistic slope stability calculations to rank the assets by their reliability index. The second, “statistical” or “data-driven” approach, uses logistical regression as a statistical tool to obtain the susceptibility ranking of the earthworks, using the database of previous failures on the network as an input. Furthermore, several methods for obtaining the temporal hazard characteristics are presented and applied, these methodologies combine to provide a full hazard assessment map of the network.

### 1 Introduction

Earthwork assets on road and rail network infrastructure are susceptible to a range of geohazards. In many areas including Ireland landslides are the most prevalent type, frequently resulting in direct damage such as fatalities, injuries susceptible and costs connected to asset remediation are high. Additionally, these events incur significant indirect damage such as line closures and traffic disruptions. As the budget available for mitigation and remediation measures is limited, identification of the most critical assets and prediction of consequences of landslides occurring on them is an important task for asset managers and infrastructure operators. This procedure is carried out through the landslide risk assessments, which is a product of landslide hazard (likelihood) and consequence (severity) of landslides on each asset [1]. Current asset managers’ practice involves using qualitative risk matrices, where

the hazard and consequence components are determined through subjective visual survey observations. However, a wealth of more advanced objective quantitative methods developed for each of the risk assessment subcomponents exists [2-4]. While these aim primarily to natural hillslopes, they can be adjusted to accommodate the specifics of engineered slopes on transport network infrastructure [5]. Examples of spatial and temporal analysis, two main landslide hazard assessment subcomponents, are presented in this paper for the case study of Irish rail network.

## 2 Landslide susceptibility analyses for Irish rail network

Landslide susceptibility analysis determines the likelihood that a landslide of a certain type will occur for each of the mapping units. It is an initial step toward hazard assessment as it produces a spatial distribution of landslide probability across the study area. Hazard assessment is then derived by combining the susceptibility analysis with the appraisal of landslide magnitude and occurrence frequency. Susceptibility analysis is undertaken using either qualitative or quantitative methods [6]. The latter is further classified into “geotechnical” (“physical”) approach based on modelling slope failure processes and “data-driven” (“statistical”) approach based on statistical evaluation of the influence of slope attributes on landslide-affected slopes. An application of each approach is presented in this chapter.

### 2.1 Geotechnical approach

A landslide susceptibility model based on probabilistic slope calculations was developed for cutting and embankments assets on Irish rail network as an initial step towards bespoke risk ranking model and decision support tool [7]. A first step included developing a structured database of geometrical, geotechnical and environmental slope characteristics for every asset. Geometrical characteristics were collated following the processing of LiDAR survey. Soil type was assigned to each asset based on the Geological Survey of Ireland’s soil cover maps using a GIS platform. This procedure was validated using discrete borehole logs located on the rail network. For each soil type, a typical range of geotechnical parameters was identified from background literature and existing geotechnical reports. This was further complemented by a detailed site investigation for six assets representative of each major soil type (Figure 1). As the Irish rail network stretches over lengths measured in hundreds of kilometres, large variability in geotechnical parameter values for each soil type can be expected. For that reason, all parameters are described using mean value and standard deviation. This enabled the performance of probabilistic slope stability calculations which give a more accurate representation of stability than standard deterministic approaches. The “Hasofer-Lind” first order reliability method (FORM) [8] was used to calculate the probability of failure associated with each asset and its coupled limit state. The “Hasofer-Lind” approach is an invariant method for calculating the reliability index  $\beta$ , which can then be transformed into a probability of failure  $P_f$ . Three limit states reflect the three failure types for which limit equilibrium slope stability calculations were carried out: (i) shallow translational, (ii) deep rotational slide, and (iii) rock wedge failure (for rock cuttings).

The calculations result in baseline probabilities of failure for each asset. Since these calculations incorporate only simple geometrical and geotechnical data, detailed observations for each asset need to be included in order to account for small differences in landslide-triggering conditions between the assets. This was done by introducing 20 degradation factors (DF) identified through collating site-specific inputs and engineering judgment from IR site inspectors. The total product of DF weights gives the final DF adjustment factor which is combined with baseline reliability indices to obtain final reliability indices and probabilities of failure (Figure 2).

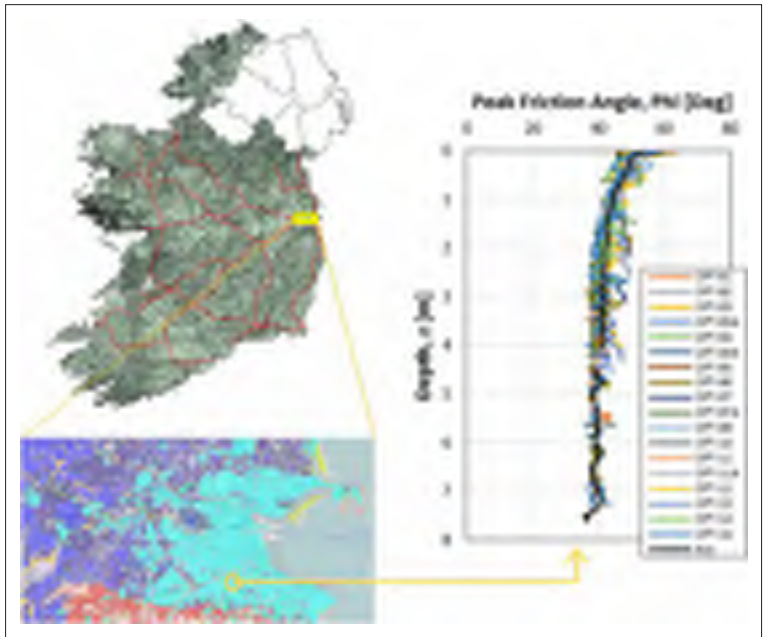


Figure 1 Defining soil types and soil characteristics for Irish Rail earthwork assets (rail lines in red)

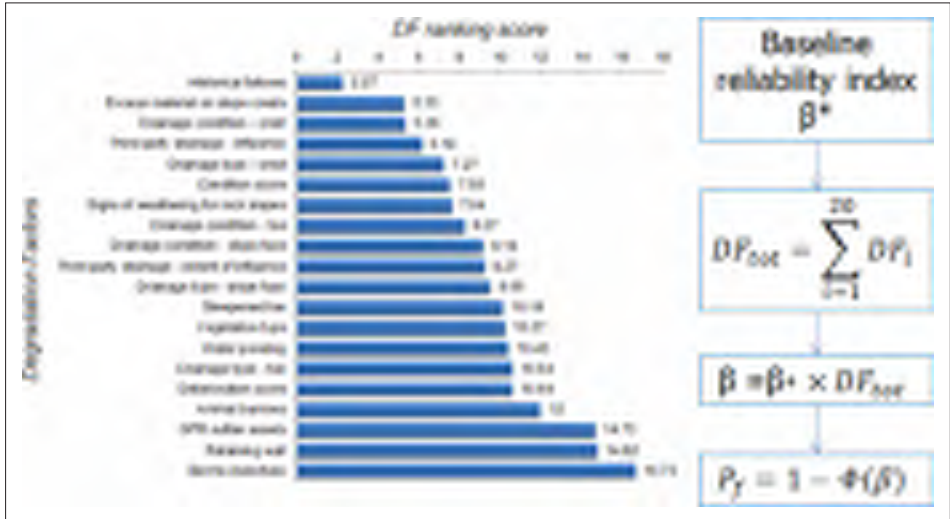


Figure 2 Overview of Degradation Factors and the outline of process for obtaining final probabilities of failure

2.2 Statistical approach

A “statistical” (or “data-driven”) logistic regression method of was used in carrying out the landslide susceptibility analysis on the Athlone Division, a section of Irish Rail network comprising about third of all earthwork assets. The statistical approach uses the historical landslide register to assess the probability of landslide on each asset by quantifying the influence of



topographical, geotechnical and environmental slope characteristics (factors) of slopes from the register. Nine factors that describe the asset have been selected, each with a number of possible classes. The factors are; slope height, slope angle, asset type, aspect, vegetation type, adjacent slope, soil type, annual rainfall and slope conditions.

The goal of logistic regression is to find the best fit model that describes the combined relationship between these factors (independent variables) and the presence or absence of landslides (dependent variable) on all slopes. The final result of this model is a probability  $p$  of the landslide occurring, ranging from 0 to 1, for each asset. Comparison of the relative influence on landslides between classes of the same factors can also be inferred from these results (Figure 4). These results for example showed that bare slopes are 4 times more likely to fail than densely vegetated ones, and that west facing slopes are 3 times more likely to fail than the east facing ones. The asset factor database was divided into training set (70 %) using which the model was set up and the validation set (30 %) against which the model results were verified. The performance of the model was interrogated using several statistical measurements such as chi-square test,  $R^2$  test and Receiver Operating Curve (ROC) which showed a very good fit of the model, as did the validation on the validation dataset. Using the calculated probabilities, assets were classified into 5 susceptibility classes: very low (79.4% of all assets), low (13.0%), moderate (3.9%), high (2.3%) and very high (1.4%); effectively identifying and ranking the top critical assets.

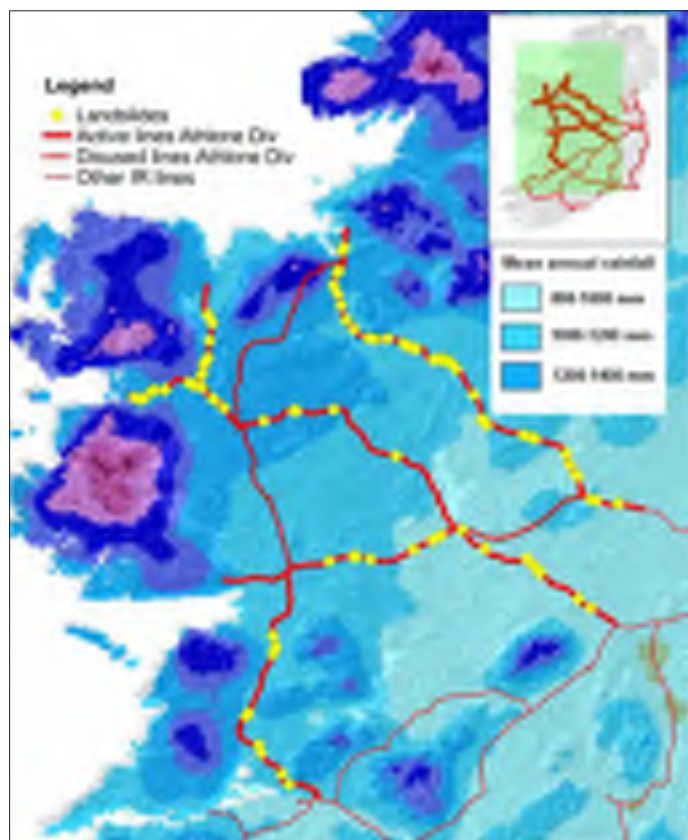
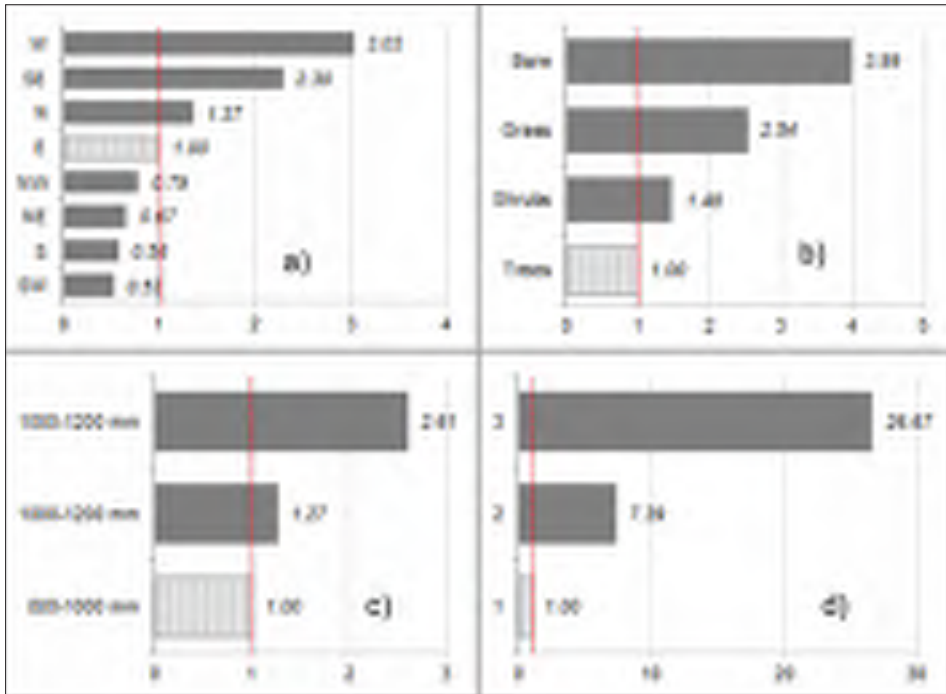


Figure 3 The locations of recorded landslides in Athlone division and mean annual rainfall in study area



**Figure 4** Contribution of each factor class to probability that landslide will occur, relative to the reference class in light grey and denoted with vertical red line for a) aspect, b) vegetation type, c) mean annual rainfall, d) slope condition

### 3 Rainfall thresholds analyses for Irish rail network

To complete the hazard assessment, the spatial distribution of landslide probability (susceptibility) has to be updated with the temporal analysis of landslide occurrences. The temporal occurrence can be expressed in terms of frequency, return period, or exceedance probability. It is often obtained through statistical empirical analysis of past failures in the study area in a discrete time interval [4]. This approach can also be used to obtain magnitude-frequency curves, jointly assessing the frequency and the size of landslides [9].

Another approach assesses the distribution of landslide trigger events rather than the distribution of past failures themselves. For rainfall-induced landslides, this can be done by defining the rainfall thresholds. Rainfall thresholds represent the lower bound of a combination of some rainfall characteristics such as intensity, duration or accumulation necessary to induce landslides. Two methods exist: “physical”, based on numerical models that take into account the relationship between rainfall, pore pressure and slope stability by coupling hydrological and slope stability models; and “empirical”, based on statistical analysis of the relationship between past failure events and rainfall [10]. Since physical models require very detailed information on soil characteristics, empirical method is much more often used.

Rainfall thresholds using empirical approach have been developed for the landslides that occurred on earthwork assets on the Irish rail network. Landslide records have been obtained from Irish Rail’s landslide register, and rainfall data was provided by the Irish Meteorological Service. In developing the thresholds, several rainfall characteristics combinations have been analysed: rainfall intensity [mm/h] – duration [h], cumulative critical rainfall [mm] – duration

[h], and cumulative critical rainfall [mm] – antecedent cumulative rainfall [mm]. A selection of results is presented in Figures 5 and 6.

Two definitions of critical rainfall event were used to describe the intensity – duration threshold. Both of them result in almost identical thresholds, defined by the power laws  $I = 9.5 * D^{-0.75}$  and  $I = 6.8 * D^{-0.65}$ . These thresholds were found to be lower than most of the thresholds developed for the central and southern Europe [11], attributed to a different climate zone (oceanic climate in Ireland is characterised by more frequent rain events but with lower rainfall intensities). Also, landslide events recorded on Irish rail line earthworks were usually single events, while some of the thresholds collated in [11] only looking at rainfall events causing large number of landslides over a limited area.

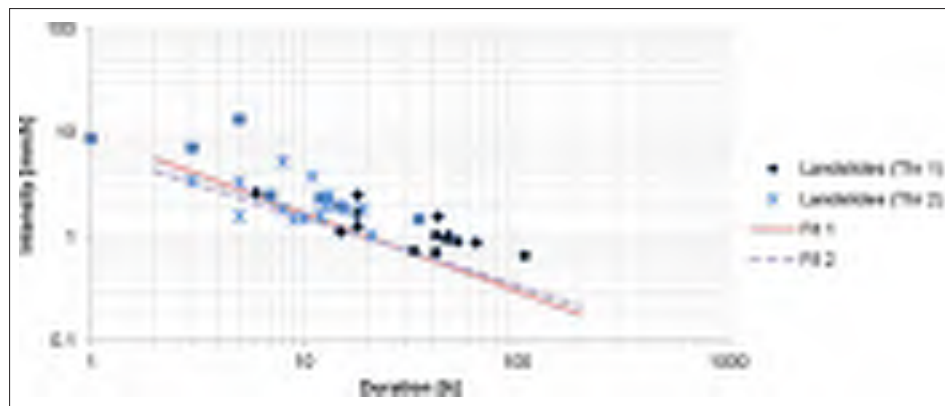


Figure 5 Rainfall intensity – duration threshold

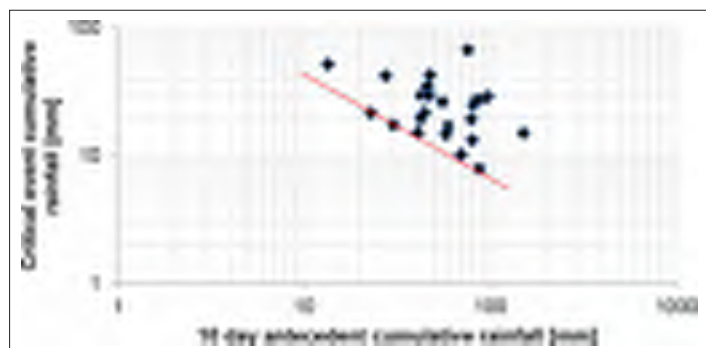


Figure 6 Critical event cumulative rainfall – 10 day antecedent cumulative rainfall threshold

## 4 Conclusions

Various advanced quantitative landslide hazard and risk assessment methods are in use for natural terrain. These can be adjusted to account for specifics attributed to the earthworks on transport networks, and thus replace the subjective and largely imprecise methods based solely on visual surveys that asset managers currently use. Nevertheless, the data asset managers routinely collect can form an important input in executing quantitative, objective, repeatable and verifiable results.

This paper briefly presents two such methods of landslide susceptibility analysis and a method of carrying out the temporal analysis for the case study of Irish rail network earthworks. The geotechnical approach to the landslide susceptibility is carried out with probabilistic limit equilibrium slope stability calculations for each asset. The statistical approach uses the historical landslide register to assess the probability of landslide on each asset given its characteristics. Temporal analysis is carried out by developing of rainfall thresholds for landslides on the rail earthwork assets in Ireland. Together, these methods give a detailed assessment of landslide hazard over Irish rail earthworks.

## Acknowledgment

This work is partly funded by the Horizon 2020 DESTination RAIL Project (Decision Support Tool for Rail Infrastructure Managers) EU Project No. 636285. This research is supported by the Irish Research Council Employment Based Postgraduate Programme scholarship fund. The authors would like to thank Irish Rail for the permission to use this data.

## References

- [1] Varnes, D.J.: Landslide hazard zonation: a review of principles and practice. No. 3. 1984.
- [2] Dai, F.C., Lee, C.F., Ngai, Y.Y.: Landslide risk assessment and management: an overview, *Engineering geology* 64, no. 1 (2002), pp. 65-87.
- [3] Fell R., Ho K.K.S., Lacasse S., Leroi E.: A framework for landslide risk assessment and management, *Landslide risk management* (2005), pp. 3-25.
- [4] Corominas, J., Van Westen, C., Frattini, P., Cascini, L., Malet, J.-P., Fotopoulou, S., Catani, F., et al: Recommendations for the quantitative analysis of landslide risk, *Bulletin of engineering geology and the environment* 73, no. 2 (2014), pp. 209-263.
- [5] Jaiswal, P., van Westen, C., Jetten, V.: Quantitative landslide hazard assessment along a transportation corridor in southern India, *Engineering geology* 116, no. 3 (2010), pp. 236-250.
- [6] Aleotti, P., Chowdhury, R.: Landslide hazard assessment: summary review and new perspectives, *Bulletin of Engineering Geology and the Environment* 58, no. 1 (1999), pp. 21-44.
- [7] Doherty, P., Gavin K., Martinović K., Reale, C.: GEORISK—A Risk Model and Decision Support Tool for Rail and Road Slope Infrastructure, *Proceedings of the International Conference on Road and Rail Infrastructure CETRA. 2014.*, pp. 573-579
- [8] Hasofer, A.M., Lind, N.C.: Exact and invariant second-moment code format, *Journal of the Engineering Mechanics division* 100, no. 1 (1974): pp. 111-121.
- [9] Hungr, O., Evans, S.G., Hazzard, J.: Magnitude and frequency of rock falls and rock slides along the main transportation corridors of southwestern British Columbia, *Canadian Geotechnical Journal* 36, no. 2 (1999), pp. 224-238.
- [10] Aleotti, P.: A warning system for rainfall-induced shallow failures, *Engineering Geology* 73, no. 3 (2004), pp. 247-265.
- [11] Guzzetti, F., Peruccacci S., Rossi M., Stark, P.: Rainfall thresholds for the initiation of landslides in central and southern Europe, *Meteorology and atmospheric physics* 98, no. 3-4 (2007), pp. 239-267.





## MULTI-MODAL RISK ASSESSMENT OF SLOPES

Cormac Reale<sup>1</sup>, Kenneth Gavin<sup>2</sup>, Karlo Martinović<sup>1</sup>

<sup>1</sup> University College Dublin, School of Civil Engineering, Ireland

<sup>2</sup> TU Delft, School of Civil Engineering, Netherlands

### Abstract

A significant proportion of European rail networks are built upon earthworks that are over one hundred years old. These earthworks are under increased pressure as they have to contend with heavier and more frequent traffic, far outside the scope of their design. To compound this problem further, recent years have seen unpredictable weather patterns develop with prolonged intense rainstorms commonplace. This has led to increased incidence of slope failures along rail networks, as many aged earthworks struggle to withstand such drastic changes in loading. Marginal engineered slopes fail depending on the triggering mechanism which presents itself first. Therefore the failure surface is intrinsically linked to the applied load i.e. surcharge loading will instigate a different type of landslide than prolonged rainfall. Therefore this paper proposes to analyse marginal slopes probabilistically as a system, where multiple slip circles are considered. A multi-modal optimisation algorithm LIPS (locally informed particle swarm optimisation) is used to locate all significant slip circles. In a slope with multiple potential failure surfaces the consequence of failure is not necessarily the same across the different slip surfaces. This paper addresses this deficit by examining the consequence of the different landslides should they occur. When combined with previously calculated probabilities of failure this will entail amount to a full geotechnical risk assessment of engineered slopes.

*Keywords: reliability analysis, risk assessment, slope stability, engineered slopes, multi-modal*

### 1 introduction

Slope instability is a major problem faced by all transport networks. This problem has increased in prevalence over recent years as a result of the increased rainfall levels brought about by climate change. This has led to a sharp increase in the number of shallow planar failures occurring annually. These failures are the result of infiltrating rainwater percolating downward through the soil. Saturating soil pore space, thereby temporarily removing the stability generated by soil suctions and consequently lowering the shear strength of the near surface soils [1, 2]. This is particularly concerning for aged transport networks such as the rail networks across both Ireland and the UK which weren't designed to modern exacting standards but were instead constructed by tipping methods in the mid-19<sup>th</sup> century. As a result many of these slopes are inclined at very steep angles, which would not be permitted by modern design guidelines [3]. This places them at an increased risk of failure. However given the scale of the networks involved and current economic circumstances, it is infeasible to replace all substandard slopes. Therefore it is imperative that we are able to identify and rank the slopes which represent the most risk to end users in order to determine which slopes to prioritise for remediation.

While significant research has been carried out on the field of landslide risk assessment it is typically carried out over a large study area using proxy measurements. This paper uses reliability theory to determine the probability of slope failure (hazard assessment). Thereby allowing for a more realistic estimate of slope capacity than traditional methods and hence a more accurate estimation of the failure probability. Furthermore, recognising that slopes are susceptible to many different failure mechanisms this paper analyses slope stability multi-modally using a particle swarm based algorithm (LIPS) which is able to detect all viable slip surfaces simultaneously. This optimisation process is used in conjunction with Bishops simplified slip circle and FORM (first order reliability method) to perform a hazard analysis in this paper.

Risk is typically defined as the product of a hazard (probability of failure) and its consequence. Naturally if a slope is subject to many different failure modes each will carry a different consequence. For example if a failure with a large volume of displaced soil occurs it will likely have greater consequence than a failure with negligible volume. This complicates slope risk assessment as the actual consequence is dependent on the particular failure event which occurs. However if all viable slip surfaces are used to perform the risk assessment the risk will more than likely be overestimated as many of the slip surfaces will be correlated. Therefore this paper performs consequence analysis and subsequent risk analysis on the slip surfaces determined to be representative by the LIPS optimisation process. Consequence is determined based on volume of soil displaced [4]. A hypothetical embankment case study is used to demonstrate the methodology.

## 2 Methodology

Risk is defined in this paper as the product of hazard and consequence. The following sections describe how hazard and consequence is obtained in this paper.

### 2.1 Probabilistic hazard assessment

Probabilistic methods have become increasingly common in Geotechnical Engineering over recent years. Slope stability in particular has received significant attention [5-8]. This is due to researchers recognizing that slope stability has significant uncertainties associated with it such as site investigation, slip surface location, climate and of course spatial variation. Reliability theory allows designers to assign statistical distributions to each variable thereby allowing for uncertainties to be accounted for within stability calculations. The performance function  $g(X)$  of a slope can be expressed as the difference between capacity (C) and demand (D), see Eqn 1.

$$g(X) = (C - D) \begin{cases} > 0, \text{ safestate} \\ = 0, \text{ limitstate} \\ < 0, \text{ failurestate} \end{cases} \quad (1)$$

$$g(X) = g(x_1, x_2, \dots, x_n) \text{ for } i = 1 \text{ to } n$$

Where  $X$  is a vector of the different random variables ( $x_i$ ) represented in the slope. Safety in a reliability analysis is typically expressed in terms of a reliability index,  $\beta$ , and a probability of failure,  $p_f$ . The probability of failure ( $p_f$ ) can be defined as the probability at which the performance function is less than zero, see Eqn 2.

$$P_f = P[g(X) \leq 0] \quad (2)$$

In a normal space, the reliability index ( $\beta$ ) is defined as the distance in standard deviations from the mean of the performance function to the design point, Eqn 3. This can be seen graphically in Fig 2.

$$\beta = \frac{E[g(X)]}{\sigma[g(X)]} \tag{3}$$

Where  $E[g(X)]$  is the mean of the performance function and  $\sigma[g(X)]$  is its standard deviation. When analysing slope stability the performance function of the slope is typically expressed as in Eqn (4).

$$g(X) = FOS - 1.0 \tag{4}$$

Where FOS is the factor of safety as defined by a relevant limit state Eqn. In this case Bishops simplified slip circle is used, see Eqn (5)

$$FOS = \frac{\sum_{i=1}^n [c_i \Delta x_i + (W_i - u_i \Delta x_i) \tan \phi_i] \frac{\sec \alpha_i}{1 + \tan \phi_i \tan \alpha_i} / FOS}{\sum_{i=1}^n W_i \sin \alpha_i} \tag{5}$$

Where  $W_i$  is the weight of the  $i^{th}$  slice,  $\alpha_i$  is the tangential angle of the base of the  $i^{th}$  slice,  $\Delta x_i$  is the  $i^{th}$  slice width,  $c_i$  is the cohesion of the soil on the base of the  $i^{th}$  slice,  $u_i$  is the pore water pressure at the base of the  $i^{th}$  slice, and  $\phi_i$  is the friction angle of the soil at the base of the  $i^{th}$  slice. To obtain the minimum FOS of a slope, either a trial and error or an optimization technique must be implemented. Similarly to obtain the maximum probability of failure an optimisation needs to be implemented to find the design points of the random variables involved as well as the critical slip circle.

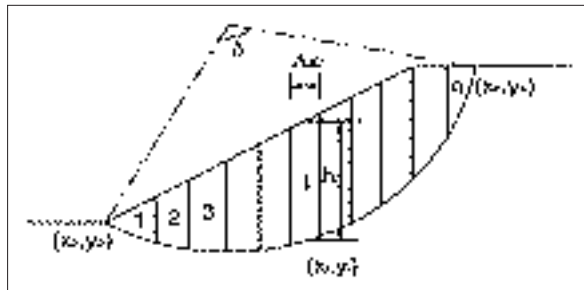


Figure 1 Terms used to describe slip surface geometry

### 2.1.1 First Order Reliability Methods Hasofer Lind

Hasofer & Lind (1974) proposed a method which assumes a first order tangent to the limit state function at the design point (i.e. when  $g(X) = 0$ ) giving an exact solution for linear performance functions and a close approximation for nonlinear functions. This method known as the Hasofer Lind reliability index requires all computation to be carried out in the standard normal space. Therefore the vector of random variables ( $X$ ) needs to be transformed into a vector of standardised normal uncorrelated variables ( $\bar{X}$ ) prior to minimisation. Eqn (6) can be used to transform random variables into the standard normal space.

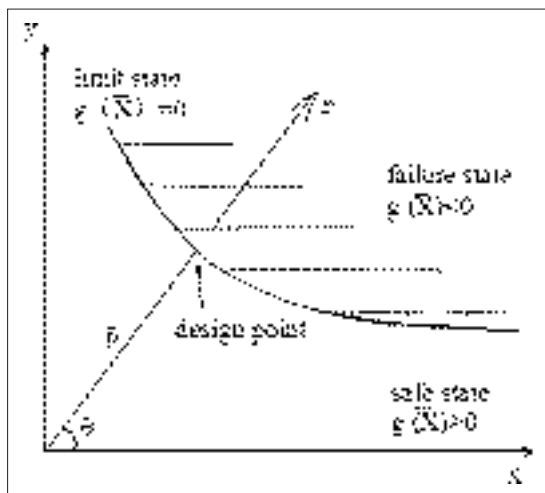
$$\bar{X}_i = \frac{X_i - \mu_{x_i}}{\sigma_{x_i}} \text{ for } i = [1, 2, \dots, n] \tag{6}$$



In this space the reliability index can be calculated by Eqn 7.

$$\beta = \min_{\bar{X} \in \Psi} \{ \bar{X} \bar{X}^T \}^{1/2} \quad (7)$$

Where the limit state surface  $\Psi$  is defined by  $g(\bar{X})=0$ .



**Figure 2** Hasofer Lind reliability index shown graphically as the minimum distance from the origin to the limit state surface in a reduced normal space.

### 2.1.2 Optimisation method- Locally Informed Particle Swarm Optimisation (LIPS)

In a multimodal problem, many extrema need to be located simultaneously, these optima can be located in vastly different areas of the search space. This paper uses a multi modal optimisation algorithm termed LIPS (locally informed particle swarm) to locate all significant minima. LIPS is a modified form of particle swarm optimisation (PSO) adapted to solve multimodal problems. PSO optimises based on how we think swarm animals such as birds find food as a group. The general principle being that each particle in the swarm represents a solution (collection of design points) to an optimisation problem. These particles iteratively move about the search space or performance function surface with a velocity. Every iteration each particle updates its velocity and its position based on that particles best solution (lowest  $\beta$  or FOS) so far (termed pbest) and the swarms best solution so far (global optima termed gbest). When a particle is near an optima its velocity decreases. Each particle is aware of the current global best solution and if the program runs for long enough all particles should move towards this point.

LIPS differs from standard PSO in that not every particle is aware of the location of the global minimum, instead each particle is aware only of its personal best solution and that of its neighbourhood. Where a particles neighbourhood, is the  $m$  closest particles to that particle measured in Euclidean distance. This allows particles to learn from those particles immediately surrounding it, while also ensuring that particles on the opposite side of the search space have no influence. This allows LIPS to develop a number of stable niches in separate areas of the search space thereby allowing the algorithm to optimise simultaneously to multiple different local optima.

The velocities ( $V$ ) and positions ( $U$ ) of the particles are updated using Eqns (8 – 10). Further details on the optimisation process can be found in Reale et al. [9, 10].

$$U_{i,d}^{t+1} = U_{i,d}^t + V_{i,d}^t \quad (8)$$

$$V_{i,d}^{t+1} = \vartheta \cdot (V_{i,d}^t + \varphi (P_{i,d}^t - U_{i,d}^t)) \quad (9)$$

$$P_{i,d}^t = \frac{\sum_{j=1}^{nsize} (\varphi_j \cdot nbest_j)}{\varphi} \quad (10)$$

Where  $\varphi_j$  is a randomly distributed number in the range of  $[0, (4.1)/nsize]$  and  $\varphi$  is equal to the summation of  $\varphi_j$ .  $nbest_j$  is the  $j^{th}$  nearest neighbourhood to  $i^{th}$  particle's personal best (pbest),  $nsize$  is the neighbourhood size and  $\vartheta$  is the inertia weight which balances the search between global and local performance.

## 2.2 Consequence analysis

Depending on the failure mode which occurs the consequence will be different. This paper assumes that the consequence is dependent on the volume of soil mobilised, or the cross sectional area of the displaced mass in two dimensions. However, some other term could easily be used to measure consequence where appropriate. In line with the methodology proposed by Zhang and Huang [4] this paper assumes that consequence is equal to the area displaced if failure occurs or 0 if failure does not occur, see Eqn 11.

$$C = \begin{cases} A_m & \text{if failure occurs} \\ 0 & \text{otherwise} \end{cases} \quad (11)$$

## 3 Case study

A hypothetical embankment is used to demonstrate the risk methodology. The embankment is approximately 10 m tall and is inclined at an angle of  $38^\circ$  to the horizontal, ground level is further inclined at an angle of  $2^\circ$  to the horizontal, see Fig 3. The embankment is founded upon a soft clay layer immediately overlying a stiff clay deposit. Gravel is found at depth. The geotechnical parameters used can be found in Table 1.

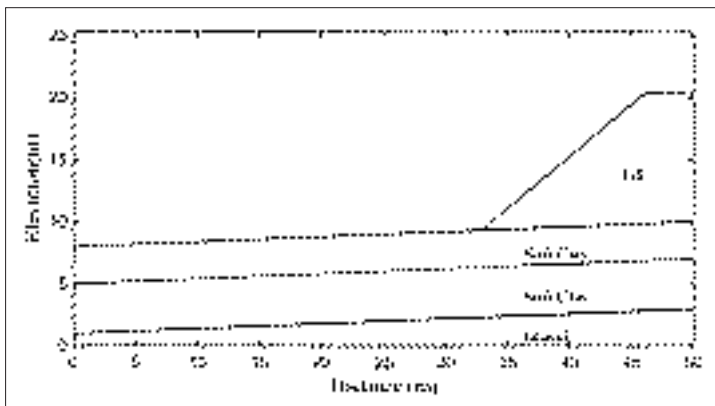


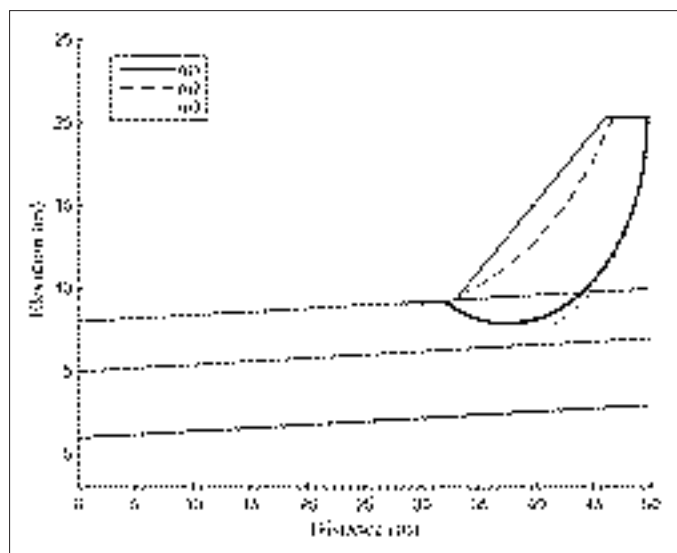
Figure 3 Slope profile

**Table 1** Geotechnical parameters used in analysis

Property	Mean	Coefficient of Variation
Cohesion (embankment) (kPa)	7	0.2
Friction angle (embankment) (°)	34	0.05
Undrained Shear Strength (Soft Clay) (kPa)	35	0.1
Friction angle (Soft Clay) (°)	0	0
Undrained Shear Strength (Stiff Clay) (kPa)	70	0.1
Friction angle (Stiff Clay) (°)	0	0
Cohesion (Gravel) (kPa)	0	0
Friction angle (Gravel) (°)	38	0.05

LIPS detected three representative slip surfaces which can be seen in Fig 4. One shallow seated failure mode was detected which was entirely contained within the embankment fill, while two deeper seated failure modes were also observed. While the critical failure mode in this case is the largest failure mode (m3), failure mode m1 may in reality be more likely to failure if climate effects are taken into account as shallow landslides are preferentially deteriorated by rainfall. Therefore it is important to analyse critical slopes multi-modally in order to get a true picture of safety.

The reliability indices, corresponding probabilities of failure and areas are given in Table 2. Failure mode m3 represents the most risk as it has both the highest probability of failure and the largest area of potential soil displacement. Similarly failure mode m1 contributes significantly to the overall risk profile as it also covers a large area. Failure mode m2 is not considered high risk, as although its probability of failure is not much less than the other two failure modes negligible soil will be displaced if failure occurs. Hence it is less likely to have a catastrophic impact. To obtain the total risk profile of the slope the risk of the individual failure modes is simply added together. In this case the total risk of a landslide on the slope is 1, see Table 2. It is important to note that this number is not a probability and is merely a dimensionless number which can be used to compare the relative risk of different slopes.



**Figure 4** Representative Slip Surfaces detected by LIPS

**Table 2** Hazard and risk results for critical slip surfaces.

Mode No:	Entry Pt	Exit Pt	$\beta$	$P_f$	Area (m <sup>2</sup> )	Risk
m1	31.8935	49.6451	3.0669	0.0011	122.6397	0.135
m2	33.1429	46.6414	3.2403	0.0006	27.80363	0.017
m3	27.8879	49.5705	2.5036	0.0062	137.2494	0.851
<b>Total risk:</b>						<b>1.00</b>

## 4 Conclusion

Across Europe Infrastructure managers are facing challenges in managing aged cutting and embankment assets with reduced budgets. Climate change is likely to cause an increase in the number of failures in these assets annually. This paper has shown the benefits of combining multi-modal optimisation algorithms with probabilistic methods for analysing existing railway slopes. The case study shows that shallow and deep seated failures, with similar probabilities of failure, can exist in the same slope. In which case, the actual critical slip surface is dependent on the triggering mechanism which presents itself first as opposed to the slip surface with the lowest reliability index. By using a multi-modal optimisation algorithm, LIPS, to calculate the probability of failure all viable slip circles are checked simultaneously, thereby eliminating the chance of a missing a key slip surface, thus removing subjectivity from the designer. However depending on the volume of soil displaced a shallow landslide may not represent that much of a risk to end users. To address this deficit this paper considers the volume of displaced soil as the consequence of a landslide occurring. Therefore by multiplying the probability of failure of each representative slip circle by the volume of soil displaced by said slip circle a risk profile can be obtained. This profile can then be used to gauge the relative risk of each failure mode and to compare the risk of slopes across an entire transport network. Thereby providing a methodology for prioritising expenditure on remediation works.

## References

- [1] Ridley, A., McGinnity, B., Vaughan, P.: Role of pore water pressures in embankment stability, Proc. Inst. Civ. Eng. Eng., vol. 157, no. 4, pp. 193–198, 2004.
- [2] Xue, J., Gavin, K.: Effect of Rainfall Intensity on Infiltration into Partly Saturated Slopes, Geotech. Geol. Eng., vol. 26, no. 2, pp. 199–209, Oct. 2007.
- [3] Jennings, P.J., Muldoon, P.: Assessment of Stability of Man-Made Slopes in Glacial Till: Case Study of Railway Slopes, Southwest Ireland, Proc. Semin. 'earthworks Transp. held in, Dublin, Ireland, 12th December 2001, 2001.
- [4] Zhang, J., Huang, H.W.: Risk assessment of slope failure considering multiple slip surfaces, Comput. Geotech., vol. 74, pp. 188–195, Apr. 2016.
- [5] Xu, B., Low, B.: Probabilistic stability analyses of embankments based on finite-element method, J. Geotech. Geoenvironmental ..., 2006.
- [6] Gavin, K., Xue, J.: Design Charts for the Stability Analysis of Unsaturated Soil Slopes, Geotech. Geol. Eng., vol. 28, no. 1, pp. 79–90, Jan. 2010.
- [7] Cheng, Y.M., Li, L., Liu, L.L.: Simplified approach for locating the critical probabilistic slip surface in limit equilibrium analysis, Nat. Hazards Earth Syst. Sci. Discuss., vol. 3, no. 2, pp. 1061–1112, Feb. 2015.
- [8] Reale, C., Xue, J., Gavin, K.: Using reliability theory to assess the stability and prolong the design life of existing engineered slopes., in Risk Assessment and Management in Geotechnical Engineering: from Theory to Practice, ASCE Geotechnical Special Publication in Memory of the Late Professor Wilson H. Tang, 2016, p. Accepted.

- [9] Reale, C., Xue, J., Pan, Z., Gavin, K.: Deterministic and probabilistic multi-modal analysis of slope stability, *Comput. Geotech.*, vol. 66, no. (5), pp. 172–179, May 2015.
- [10] Reale, C., Xue, J., Gavin, K.: System reliability of slopes using multimodal optimisation, *Géotechnique*, vol. 66, no. 5, pp. 413–423, Jan. 2016.



## REMEDICATION OF KARST PHENOMENA ALONG THE CROATIAN HIGHWAYS

Mario Bačić<sup>1</sup>, Bojan Vivoda<sup>2</sup>, Meho Saša Kovačević<sup>1</sup>

<sup>1</sup> University of Zagreb, Faculty of Civil Engineering, Croatia

<sup>2</sup> Rijeka – Zagreb Motorway, Croatia

### Abstract

More than 50 % of Croatia's area is situated in karst terrain which is characterized by dissolution of limestones, dolomites and other soluble rock masses under the influence of water, CO<sub>2</sub>, temperature etc. As a consequence of this process, often referred to as 'karstification', a large number of karst phenomena is linked with engineering activities and directly influence existing infrastructure, especially national highways and roads. Since many highway sections, out of 1300 km in total, are constructed in karstification susceptible terrain, phenomena such as faults or caverns can have large impact both on construction works as well as on structure behaviour during exploitation. The latter became more obvious in last few years since number of exploitation issues have been reported. Few of these phenomena are presented in this paper, including cavern near Bosiljevo exit, suffosion sinkhole near tunnel Sv. Marko and bulging of pavement near tunnel Veliki Glozac due to karstification of bottom layers. Besides describing the nature of these phenomena, this paper presents a methodology for their remediation combining different non-invasive geophysical methods whereas method of seismic refraction will be shown in this paper since it yields best results for fulfilment of task. The main advantage of this methodology is to obtain relatively precise information about presence, distribution and size of karst features in fast and simple manner. Based on these data, a technical documentation including remediation measures was prepared and the remediation works were conducted, or will be conducted, accompanied by detailed quality control program.

*Keywords: karstification, highways, cavern, suffusion sinkhole, seismic refraction*

### 1 Introduction

Croatia is situated in south-east Europe and, according to Kovačević et al. [1], more than half of the its area of (or over 70% if taking into account the Croatian Adriatic seabed) is situated in karst terrain, Figure 1. Field [2] explains that the karst is 'the result of natural processes on and in the earth's crust caused by the dissolving and rinsing of limestone, dolomites and other soluble rock masses'. Dissolution of limestones and dolomites, which are dominant rock masses in Croatia, is under influence of many factors such as water presence, CO<sub>2</sub> content, saturation level, temperature etc. The process of carbonate rock dissolution is often called karstification. Regarding their morphology, karst phenomena can roughly be divided on surface features and underground features. Jurić-Kačunić [3] gave an extensive description of all karst features. Surface features may be small scale such as flutes, runnels, clints and grikes, medium-scale such as sinkholes, vertical shafts, foibe, disappearing streams, and reappearing springs or large-scale such as polje and karst valleys. As a consequence of karstification, a large number of karst phenomena is linked with engineering activities and directly

influence existing infrastructure, especially national highways and roads. These features can impact physical-mechanical behaviour of rock and can have large impact both on construction works and behaviour of structure during its exploitation. One of most interesting examples of karst-related issues during construction of Croatian highways is the cavern which was found during construction work of tunnel Vrata [4], Figure 2.



Figure 1 Karst regions in Croatia [1]

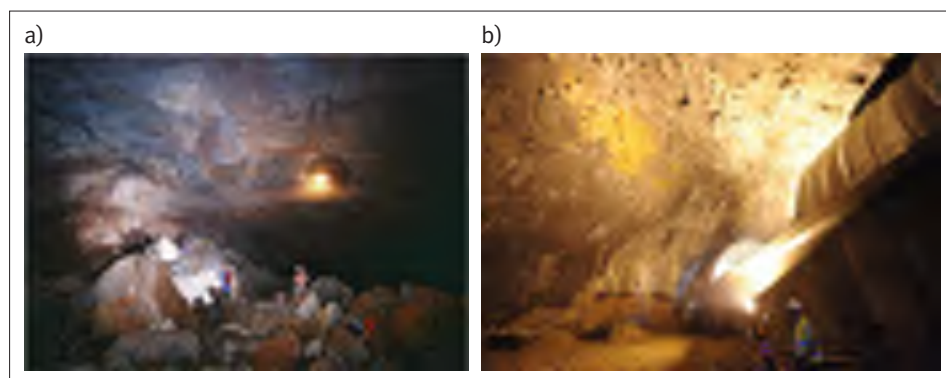


Figure 2 Cavern in tunnel Vrata: a) after detection, b) after remediation [4]

During tunnel mining, a 50 000m<sup>3</sup> cavern was discovered, Figure 2a, and fast and effective remediation measures needed to be implemented. Remediation measures therefore included an innovative solution of constructing a bridge inside tunnel pipe, Figure 2b.

However, in recent years, problems regarding exploitation of highways and roads in karst terrain became more obvious with a large number of exploitation issues being reported. Some of these phenomena are presented in the paper, and include cavern near Bosiljevo exit, suffusion sinkhole near tunnel Sv. Marko and bulging of pavement near tunnel Veliki Glozac due to karstification of bottom layers.

## 2 Methods for detection of karst phenomena

The basic method for detection of karst phenomena is most certainly method of visual inspection. However, the main issue regarding visual inspection is that hidden effects can be overlooked and that visual inspection is very susceptible to subjective assessment. This is especially significant when it comes to underground karst phenomena. Besides visual inspection, an invasive method of borehole drilling is traditionally used as main method for engineering – geological interpretation of underground. Even though borehole drilling gives unique information about is expensive and although it gives about geotechnical parameters, those information are obtained in discrete area (point information) and as such drilling is ineffective tool for detection of extent and scale of underground anomalies.

To overcome issues posed by invasive methods, non-invasive geophysical methods have been applied extensively in civil engineering in last few decades. Even though the main advantage of these methods is in considerable savings of time and financial resources, there is still a lack of information on selection of suitable methods and measurement parameters when using geophysical methods for investigation of karst phenomena [5]. Another disadvantage of geophysical methods is that they cannot directly (without correlation) provide information about some important physical-mechanical characteristics of rock, but this is not of great importance when it comes to simple mapping of subsurface. Generally, non-invasive geophysical methods can be divided to geoelectric, seismic and electromagnetic methods. Each of these groups consists of large number of methods and few of them have been used for detection of karst phenomena along Croatian highways. These methods include seismic refraction method, multichannel analysis of surface waves and electromagnetic method of ground penetrating radar. However in this paper, results of seismic refraction method will be presented since it was shown that, out of mentioned, this method yields best results when it comes to mapping of karst phenomena.

The main objective of the seismic methods is to define the profile of the elastic waves velocities in depth which are in direct contact with the elastic stiffness properties of the material through which they travel. Such elastic waves spread through the soil or rock after they were generated by impulse or controlled vibration on the surface. When they arrive at the border of layers of different seismic velocity, waves are reflected or refracted after which they travel back to the surface. Refraction waves are longitudinal (P) waves and they are conducted according to Snell's optics law of spreading rays in stratified medium. The method is based on the analysis of artificially created seismic waves that are generated from the surface and which are detected by measuring sensors – geophones, placed on pre-defined positions. After analysis, the final output is profile of longitudinal waves of investigated subsurface.

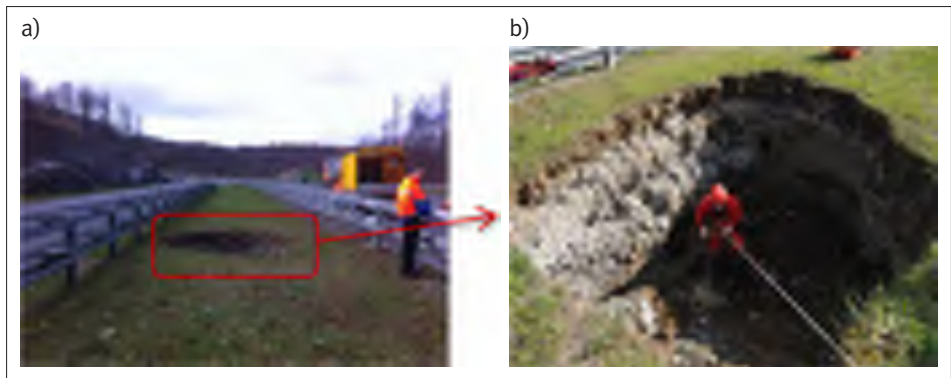
## 3 Examples of karst phenomena along Croatian highways

Even though large number of different issues have been reported and consequently treated, this paper presents only few of them.

### 3.1 Example 1: Cavern in 9<sup>th</sup> kilometer of the Rijeka-Zagreb highway, near Bosiljevo exit

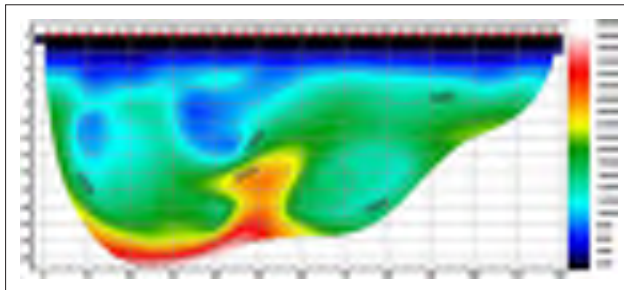
In February 2014, on the 9<sup>th</sup> kilometer of the Rijeka-Zagreb motorway (red dot on Figure 1), in the direction of Zagreb, an opening with depth of approximately 3 m and aperture area of 10 m<sup>2</sup>, appeared between the two lanes, Figure 3a. Detailed geological mapping, Figure 3b, indicated that the reason for this is due to so-called 'reverse' karstification where the rock mass dissolves from bottom layers to top layers. After significant degree of karstification, the collapse of surface material in the cavern located at greater depth was inevitable.





**Figure 3** Opening in 9<sup>th</sup> km: a) Position of opening, b) geological mapping

Besides conduction of geological investigation, a geophysical investigation was carried out where the methods were chosen according to the geological structure of the ground and geotechnical nature of the problem related to the design requirements. Two investigation geophysical methods were therefore chosen. Ground penetrating radar profiling was used to identify potentially karstification-caused anomalies beneath the road which could endanger its functionality, while seismic refraction geophysical surveys were carried out in the area between the lanes and it was used to determine the volume and position of the cavern. After interpretation of refraction data, a longitudinal velocity profile was obtained and it is shown on Figure 4. A feature which can be easily seen is an area of reduced velocity of seismic waves between 30<sup>th</sup> and 45<sup>th</sup> meter of profile and on 6<sup>th</sup> to 14<sup>th</sup> meter in depth. This area is assigned to cavern which caused collapse of material on surface.



**Figure 4** Refraction profile on 9<sup>th</sup> kilometer of the Rijeka-Zagreb highway

The remediation of cavern [6] consisted of two phases where, in the first phase, cavern was filled with fine-grained concrete. In second phase, a stabilization of the cavern surrounding area was done with 'contact grouting' method. After completing these phases, a surface hole was filled with gravel and reinforced slab was constructed on surface. By conducting seismic refraction investigations, a volume of cavern was estimated to be 160 m<sup>3</sup>, while during remediation works total amount of fine-grained concrete which was used for filling of cavern was 130 m<sup>3</sup>. This can be considered as good estimation.

### 3.2 Example 2: Suffosion sinkhole on the Rijeka-Zagreb highway, near Sv. Marko tunnel

During rainy period of winter 2014/2015, an opening of unknown genesis and morphology appeared near electrical substation in km 46+300 of Rijeka-Zagreb highway, next to the entrance to sv. Marko tunnel (blue dot on Figure 1). The aperture area of 13 m<sup>2</sup> was located next

to western part of highway security fence. Also, extensive bulging of terrain was observed in area around opening, Figure 7a. It is significant that these phenomena occurred at the very end of drainage system of tunnel cutting slopes.



Figure 5 Suffusion sinkhole in 46<sup>th</sup> km: a) location, b) suffusion mechanism [7]

Based on investigation works which consisted of geological and geophysical investigations, it was concluded that the main reason for formation of opening is suffusion. According to Field [2], suffusion can be classified ‘undermining through removal of sediment by mechanical and corrosional action of underground water’. Since the terrain on the location is made of disintegrated clastic formations of clay, silt and sand mixture, overlying fractured dolomite, the soil profile makes it very susceptible to process of suffusion. Additionally, the surface drainage system accelerated this process since surface channels end just above the location of suffusion. Therefore, genesis of this phenomenon should not be searched in underground but rather on surface, where larger inflow of water from cuttings had mechanical impact on unconsolidated sediments transporting them into upper karstified dolomite. Figure 6. shows a seismic refraction profile where the zones of lower longitudinal wave velocities can be seen in upper part with clearly visible clay pockets.

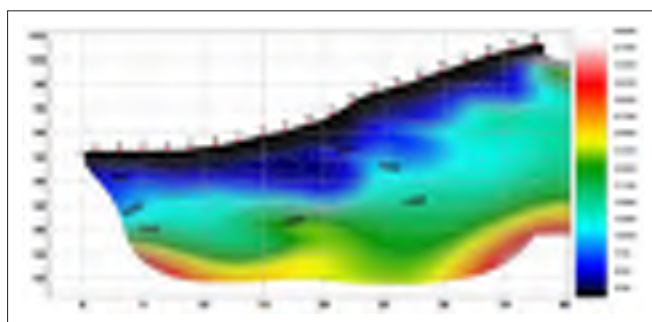


Figure 6 Refraction profile on 46<sup>th</sup> kilometer of the Rijeka-Zagreb highway

As an optimal remediation solution [8], a three phase remediation plan is established. First phase includes jet-grouting of unconsolidated sediments in order to bind soil particles by forming soilcrete with higher stiffness and strength. Raster of grouting positions is determined as 2.5 x 2.5 m triangular. After stabilization of surrounding area, next phase includes filling of the sinkhole with granulated material fraction ranging from 0 to 63 mm, while final phase includes reconstruction and extension of surface drainage system. By doing this, a further potential formation of suffusion sinkholes will be prevented.

### 3.3 Example 3: Pavement bulging on the Rijeka-Zagreb highway, near Veliki Glozac tunnel

Near the exit from Veliki Glozac tunnel, in km 9+500 of Rijeka-Zagreb highway (green dot on Figure 1), a pavement bulging phenomenon was noticed. The bulging occurred in length of 6 m with 20 cm pavement denivelation, covering two highway lanes, Figure 7a. After conduction of geological and geophysical investigation works, it was concluded that the reason for bulging is result of steeply sloping speleological object which was partially detected during construction of highway back in 1997. and 2001. Rock mass in which this speleological object was formed, has been partially mined for construction of tunnel cuttings. However, it is possible that one part of the same speleological object, which was in fossil phase of speleogenesis, remained under the lanes of highway where bulging occurred.

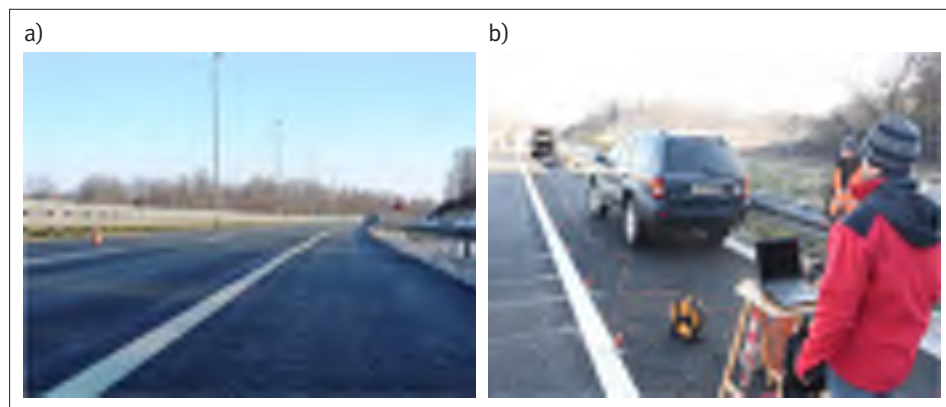


Figure 7 a) Pavement bulging in 9.5<sup>th</sup> km, b) seismic data acquisition

On this basis, a complete seismic profiling was conducted, consisting of seismic refraction method and multichannel analysis of surface waves method. The acquisition of data posed some problems since each geophone had to be drilled inside pavement in order to collect data properly, Figure 7b. One resulting refraction profile is shown in Figure 8. where three zones of reduced wave velocities can be distinguished. These zones are located to the depth of 12 meters, just below the location of pavement bulging. Therefore, it was decided that proper remediation measures must be taken into account.

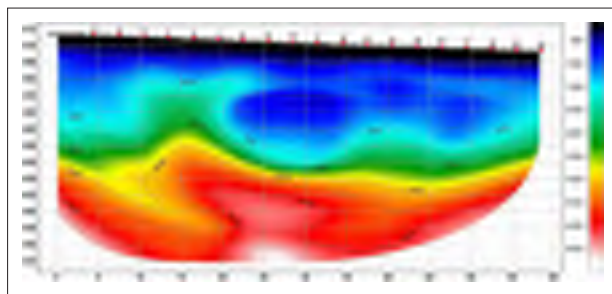


Figure 8 Refraction profile on 9.5<sup>th</sup> kilometer of the Rijeka-Zagreb highway

Planned remediation measures [9] consist of removal of existing pavement as initial phase. After that, a filling of the cavern with fine-grained concrete is planned where drilling holes will be used in same time as prospection holes to determine the actual state of rock mass in base. Next, surrounding area will be stabilised by contact grouting method, following levelling

and compaction of highway subbase layers. As final phase, 18 cm thick reinforced slab will be constructed as well as layers of binding and dense tar surfacing materials.

## 4 Conclusion

Since the large part of Croatian highways is located in karst terrain, susceptible to process of rock mass dissolution, a number of issues regarding their exploitation have been reported in last few years. Some of these include cavern between highway lanes in 9<sup>th</sup> kilometer, pavement bulging due to karstification of bedrock layers in 9.5<sup>th</sup> kilometer and sinkhole suffusion on 46<sup>th</sup> kilometer, all on Rijeka – Zagreb highway. To form a basis for remediation measures, a geological and non-invasive geophysical investigation works were conducted. While the geological investigation works provide answers to genesis and nature of each problem, geophysical investigation works provided an estimation of volume and extent of karst phenomena. Between few methods used for multi-geophysical approach, a method of seismic refraction yielded best results when it comes to mapping application. For each problem, a detailed design documentation was prepared including remediation measures conducted in several phases. All remediation works are accompanied by detailed quality control program.

## References

- [1] Kovačević, M.S., Jurić-Kačunić D., Simović R.: Determination of strain modulus for carbonate rocks in Croatian karst (In Croatian), GRAĐEVINAR 33 (2011) 1, pp. 35-41.
- [2] Field, M. S.: A Lexicon of Cave and Karst Terminology with Special Reference to Environmental Karst Hydrology, U.S. Environmental Protection Agency, Office of Research and Development, National Center for Environmental Assessment, Washington Office, Washington, DC, EPA/600/R-99/006, 1999.
- [3] Jurić-Kačunić, D.: Stiffness of Carbonate Rock in Croatian karst (In Croatian), Dissertation, Faculty of Civil Engineering, University of Zagreb, Zagreb, 235 p., 2009.
- [4] Garašić, M., Kovačević, M.S., Jurić-Kačunić, D.: Investigation and remediation of the cavern in the vrata tunnel on the Zagreb – Rijeka highway (Croatia), ACTA CARSOLOGICA 39 (2010) 1, pp. 61-77.
- [5] Kearey, P., Brooks, M., Hill. I.: An Introduction to Geophysical Exploration, Blackwell Science Ltd, Oxford, England, 2002.
- [6] Faculty of Civil Engineering, University of Zagreb: Sanacija kaverne na dionici Vrbovsko-Bosiljevo, u 9 km od čvora Bosiljevo II (In Croatian), detailed design IZP-110-020/2014, May 2014.
- [7] URL: [www.sinkhole.org](http://www.sinkhole.org) (21.03.2016.)
- [8] Faculty of Civil Engineering, University of Zagreb: Propadanje tla na pokosu, dionici Karlovac -Bosiljevo u km 46+300, autoceste Rijeka – Zagreb, u smjeru Rijeke (In Croatian), detailed design IZP-110-031/2015, May 2015.
- [9] Faculty of Civil Engineering, University of Zagreb: Sanacija ulegnuća kolnika iza izlaznog portala tunela Veliki Gložac, km 9+500, južni kolnik, smjer Zagreb, autocesta A6 (In Croatian), detailed design IZP-110-006/2016, January 2016.





## VOLUME MEASUREMENTS OF ROCKFALLS USING UNMANNED AERIAL VEHICLES

Marijan Car, Danijela Jurić Kačunić, Lovorka Librić  
*University of Zagreb, Faculty of Civil Engineering, Croatia*

### Abstract

Abrupt climate changes cause increasing occurrence of rockfalls which are significant and ongoing threat to infrastructure network, particularly for those located within steep terrain. Better understanding and timing where to focus attention for this matter is crucial for the infrastructure companies, which can avoid high cost of damages caused by rockfall hazards. Hazard analysis has historically relied on visual inspection of experienced field engineers assessing each site, which is not time or cost effective. In recent years, the usage of unmanned aerial vehicles (UAVs) is becoming increasingly common, especially for applications concerning natural disasters. By using unmanned aerial vehicles the traditional methods of mapping, determining the volume, cross-sections, contours and other parameters that are required for rockfall engineering analysis can be altered, improved, or even completely replaced. The paper presents the legislation and scientific research initiatives for determining the volume of boulders with unmanned aerial vehicles.

*Keywords: boulder, ortophoto maps, point cloud, rockfalls, transport infrastructure, Unmanned Aerial Vehicles*

### 1 Introduction

Rockfalls are a major threat in areas characterized by highly diversity of lithostratigraphic soil compositions [1], high degree of tectonic and seismic activity, complex geological characteristics, various relief features, unfavourable climatic conditions, water network development and significant anthropogenic influence on relief shaping. During the last decade a large number of rockfalls occurred on the steep karst slopes along the Adriatic Coast of Croatia, causing serious damages to buildings and transport infrastructure, which resulted with traffic delays on roads and railways with expensive remediation measures [2].

A rockfall is defined as a rock mass that has detached from a steep slope or cliff along a surface with little or no shear displacement and descends most of its distance through the air [3]. Once a rock block has detached from the steep slope, it will free fall, topple, bounce, roll or slide along the slope surface at a high speed, which can cause significant damages to the facilities at the bottom of the slope.

Investigation of rockfall hazards and rockfall hazard mitigation requirements in Croatia were increased during the last decade after large rockfalls occurred on the steep karst slopes along the Adriatic Coast of Croatia [4]. Majority of sections of Croatian Highways A1, A6 and A7, in total 570 km of length and Croatian Railways, round 650 km of length are situated in the karst terrain with numerous slopes cut in the karstic rock (Figure 1).

Karst takes more than a half of the Croatian area (52%) and over 70%, if Croatian Adriatic seabed is taken into consideration [5]. It is located from Slovenia in the northwest, to the southeast of Montenegro and his northern border goes south from Karlovac to the east where

it crosses into Bosnia and Herzegovina. Karst morphological form is including skraps, valleys, pits, sinkholes, coves, fields, caves, caverns, etc. and his hydrological forms includes confluence with rapid drainage, underground rivers, estavelles, surface springs and submarine sources.



Figure 1 Map of Croatian karst area with some rockfall locations

## 2 Jurdani rockfall survey with UAV

Accessing and mapping rockfall locations with Unmanned Aerial Vehicle (UAV) can be used to collect series of high resolution images from which is possible to create Digital Terrain Model (DTM) of a rockfall area. By using such models it is possible to generate very accurate data of volumes, areas, surfaces, cross sections and contour lines in a very short time and replace traditional methods of mapping such areas.

On the railway line M203 between stations Jurdani and Matulji is a location of potential rockfall and it was photographed with UAV DJI Phantom 2 Vision+ [6]. With this type of Unmanned Aerial Vehicle it is possible to take a lot of pictures in very short time, which depends on the experience of the pilot. In this case 69 pictures was taken, which were used later on in mapping software Pix4Dmapper Pro [7]. Combination of such UAV and mapping software is a powerful tool which can generate data for all computer programs who are used for rockfall simulations, one of them is Rocfall [8].

It is a computer program easy to use, which performs probabilistic simulation of rockfalls or landslides and can be used for designing barriers and testing their effectiveness. Rocfall based on input data (slope geometry, characteristics of slope materials, block size, block starting position and starting speed) calculates the trajectory of a block and as output data gives speed, position and kinetic energy of block. Output form also gives a histogram showing distribution of velocity, kinetic energy and stepping height of the blocks in relation to any location along the slope profile.



## 2.1 DJI Phantom 2 Vision+

Company DJI [6] is one of global leaders in the development and production of simple to use and reliable small unmanned aircraft for commercial use and recreation. Model Phantom 2 Vision+ is one of the top sellers, most simple and very easy to use. Unfortunately his production has been terminated, but was replaced with newer versions like Phantom 3 and Phantom 4, while technology and other operating principles on new drones remains the same or slightly enhanced. This UAV (unmanned aerial vehicle) has four propellers (quadcopter) and is equipped with a camera attached to the bottom that can record high-resolution images or high-definition video (Figure 2). It also comes with many other features for recording digital imagery. A user can control the device using a remote control connected to almost every smartphone, where live video from the drone's camera can be streamed. By using images supplied to the smartphone, pilots can navigate the drone even when it is out of a direct line of sight.



Figure 2 Parts of DJI Phantom 2 Vision+

## 2.2 Pix4Dmapper Pro

Pix4Dmapper Pro is software that automatically processes the images that were taken from the air using unmanned aircraft, or from the ground with digital camera. It uses technology that works on the principle of recognizing the image content (pixels) in order to make a complete 3D model of the subject (Figure 3). The software is completely adaptable to all types of cameras and image processing results can be converted and used by any GIS or CAD applications. Pix4Dmapper Pro can be used in many different branches of industry and science, such as mining, agriculture, geodesy, civil engineering, management of natural resources and emergency services, and allows following:

- line and polyline measurement (break lines), making longitudinal and cross sections, contour drawing, measuring areas and volumes directly in the model and their export to other different formats
- generating 3D point cloud, true orthomosaic and orthophoto maps, 3D textured models, DSM (Digital Surface Model), NDVI Maps (normalized difference vegetation index) from vertical and oblique aerial or terrestrial photos
- it uses a fully automated flow of data processing and calibration of each photo in order to achieve a satisfactory level of accuracy, but also the “Rapid Check mode” for checking the quality of recording directly on the field



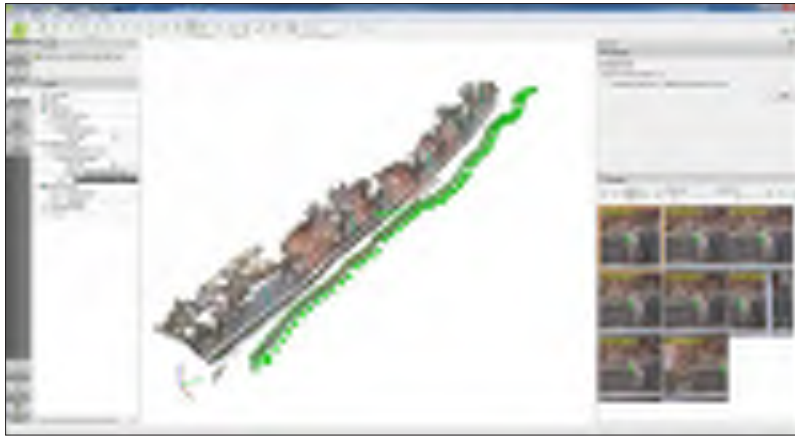


Figure 3 Pix4Dmapper Pro user interface

### 2.3 Flight preparation

Upon arrival at the location the first step is to prepare flight of aircraft which is done by connecting smartphone with UAV through wireless connection, and upload the map of the location to the smartphone. To prepare a flight it is needed to set up dimensions of mapping area in Pix4D capture [9] application, flight orientation and altitude as well as drone airspeed. In this particular case, flight was carried out in “free flight mission” mode which means that one set of parameters had to be added. Horizontal and vertical change of camera position through GPS (Global Positioning System) were set in the way that when camera moves by 2 meters (Figure 4) it will automatically take a photo and save a GPS coordinate of a photo position.



Figure 4 Screen shot of the map location “Jurdani” from smartphone

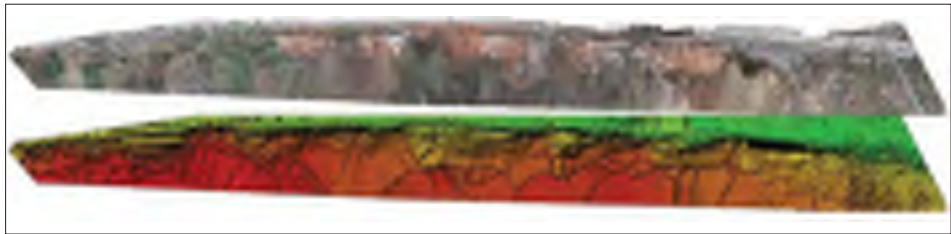
### 2.4 Office work

By uploading such geocoded images taken from air in Pix4Dmapper Pro it displays flight path and the position of each photo that was taken (Figure 5).



**Figure 5** Screen shot of Pix4D mapper Pro with positions where images were taken

Photo processing, generating point cloud and orthophoto map takes place automatically by SFM algorithm (Structure From Motion) [10] by Pix4Dmapper Pro. Depending on the power of the processor and graphics performance of a computer after some time software generates orthophoto map and Digital Surface Model (DSM) (Figure 6) and 3D view of the terrain in the form of a point cloud (Figure 7).



**Figure 6** Orthophoto map and Digital Surface Model (DSM) generated by Pix4Dmapper Pro from photos taken from air



**Figure 7** Point cloud generated by Pix4Dmapper Pro from photos taken from air

Result of this way generated point cloud and orthophoto map it that they are fully measurable at every part of the created model. It is allowing us to produce longitudinal and cross sections (Figure 8), contour drawing, measuring areas and volumes (Figure 9) directly in the point cloud model and their export to other different CAD format (Computer Added Design) who are used in most professions related for mapping and design.



Figure 8 Example of cross section generated in Pix4Dmapper Pro



Figure 9 Volume generated in Pix4Dmapper Pro

### 3 Conclusion

Application of Unmanned Aerial Vehicles (UAVs) can deliver high-resolution remote sensing data on rockfalls which are constantly appearing in Croatian karst. Compared to conventional classical methods for mapping rockfalls, new technologies and software can save a lot of time and money, especially when the area of interest is hazardous, dangerous and inaccessible delivering data which is more than sufficient for rockfall analysis.

## References

- [1] Geologic TimeScale Foundation – Stratigraphic Information, Lithostratigraphic Units, [https://engineering.purdue.edu/Stratigraphy/strat\\_guide/litho.html](https://engineering.purdue.edu/Stratigraphy/strat_guide/litho.html), 26.04.2015.
- [2] Librić, L., Car, M., Kovačević, M.S.: Methods of surveying in rockfall protection, 3<sup>rd</sup> International Conference on Road and Rail Infrastructure CETRA 2014, pp. 617-622.
- [3] Hoek, E., Bray, J.: Rock slope engineering, The Institute of Mining and Metallurgy, London, 1981.
- [4] Arbanas, Ž., Grošić, M., Udovič, D., Mihalić, S.: Rockfall Hazard Analyses and Rockfall Protection along the Adriatic Coast of Croatia, Journal of Civil Engineering and Architecture, Mar. 2012, Volume 6, No. 3 (Serial No. 52), pp. 344–355, ISSN 1934-7359, USA
- [5] Lončar, N., Garašić, M.: Osnovna obilježja krškog reljefa – nedovoljno istraženo i zaštićeno bogatstvo, Okoliš, Glasilo Ministarstva zaštite okoliša i prostornog uređenja, Zagreb, str. 33, 2002.
- [6] DJI Phantom 2 Vision+, <http://www.dji.com/product/phantom-2-vision-plus>, 22.03.2016.
- [7] Pix4Dmapper Pro, <https://www.pix4d.com/product/pix4dmapper-pro/>, 23.03.2016.
- [8] RocFall, <https://www.rocscience.com/rocscience/products/rocfall>, 23.03.2016.
- [9] Pix4D capture application, <https://www.pix4d.com/product/pix4dcapture-app/>, 24.03.2016.
- [10] Xiang, T., Cheong, L-F.: Understanding the Behavior of SFN Algorithms: A Geometric Approach, Electrical and Computer Engineering Department, National University of Singapore, [https://www.eecs.qmul.ac.uk/~txiang/publications/xiang\\_IJCV\\_VISI488\\_01F.pdf](https://www.eecs.qmul.ac.uk/~txiang/publications/xiang_IJCV_VISI488_01F.pdf), 2001





## MONITORING OF INFLOW GROUNDWATER INTO SUBWAY STATION IN SOUTH KOREA

Bo-Kyong Kim<sup>1</sup>, Young-Kon Park<sup>1</sup>, Sung-Jin Lee<sup>1</sup>, Jin-Wook Lee<sup>1</sup>, Sun-Il Kim<sup>1</sup>, Seong-Chun Jun<sup>2</sup>

<sup>1</sup> UGS Convergence Research Program, Korea Railroad Research Institute, Republic of Korea

<sup>2</sup> GeoGreen21 Co., Ltd., Republic of Korea

### Abstract

This research carried out investigations on the hydrogeological characteristics of inflow groundwater into subway station in South Korea. It is well known that the behaviour of groundwater around urban area has greatly affected risks on ground subsidence as well as underground structures. Especially, there are many cases of urban sinkhole due to a large volume of groundwater generated during the construction and operation of subway system in South Korea. There are 16 lines of subway with 481 stations in 6 cities in South Korea, and the half of them are placed in Seoul, the capital of South Korea. About 10,000 m<sup>3</sup>/day of groundwater was inflow into subway stations in Seoul. In order to investigate the characteristics of inflow groundwater, a test-bed station was monitored for several parameters such as the volume of inflow, water temperature, and electric conductivity, etc. for several months. With geological properties of ground and environmental factors such as rainfall and surface water near the station, the monitoring data was analysed to estimate their correlation and abnormal behaviour. Further studies are ongoing to setup a real-time inflow groundwater monitoring and risk assessment and risk assessment system, which would prevent risks on the underground near subway and its infrastructures.

*Keywords: inflow groundwater, subway, ground subsidence, monitoring, tunnel*

### 1 Introduction

In recent years, there has been increased accidents related to ground subsidence in urban area, so called “urban sinkholes”, around the world. A sinkhole is basically formed by a void under the ground which can be induced naturally and/or by human activities. Areas of ground that has the rock easily dissolved by water, such as limestone, salt bed, carbonate rock, etc., could have sinkholes naturally. For example, it has been well known Florida’s peninsula in United States is made of carbonated rock, resulting in karst terrain and many cases of sinkholes has been found in Florida. Otherwise, human activities can also trigger ground failure and subsidence, such as heavy pumping of groundwater, investigative drilling, excavation, and construction/operation of underground facilities. In 2015, there was an accident where two pedestrians swallowed by sinkhole in Seoul. The place was cited in the middle of downtown, and it was found just next to a construction site where 39-story building are being built. It has been assumed the cause of collapse was water coming out of the retaining wall which resulted in drain of soil. It was reported that ground failure and subsidence events had been yearly increasing in South Korea. According to National Disaster Management Institute in Korea, there has been 36 sinkholes happened in Korea for 10 years since 2015. Among them, 32 cases (78.8%) were occurred by human activities, such as deterioration of sewer pipelines, construction of subway, excavation, etc. [1].

During the construction and operation of massive facilities such as subway, underground structures, it is possible that a large volume of groundwater is discharged. Unlike groundwater discharged from localized underground facilities, inflow groundwater into subway system influenced on much wider area due to its net-like structures. It may occur serious decrease of groundwater level, which followed by ground subsidence and adverse effect on the stability of underground facilities. We have studied on technologies to monitor the characteristics of inflow groundwater into subway and to assess its risks on ground subsidence.

In this paper, investigations on the hydrogeological characteristics of inflow groundwater into subway station were overviewed and its status for South Korea was described. In addition, data from a test-bed study of inflow groundwater into a subway station was discussed.

## 2 Characteristics and effect of inflow groundwater into subway

### 2.1 Amount of inflow groundwater and related parameters

When the subway tunnel was constructed under the groundwater level, the void in tunnel has atmospheric pressure and groundwater tend to inflow into tunnel. Goodman et al. [2], Lei [3], Park et al. [4] conducted studies on analytical formulations. Equation (1) shows the rate of inflow groundwater per unit length of tunnel, where the tunnel discharges as steady state [2].

$$Q_0 = \frac{2\pi KH_0}{2.3\text{Log}(2H_0/r)} \quad (1)$$

Where:

$Q_0$  – amount of inflow groundwater;

$K$  – hydraulic conductivity;

$H_0$  – groundwater level measured from the head of tunnel;

$r$  – tunnel's diameter.

When the discharged amount of groundwater is large enough to change groundwater level, that is, transient state,  $Q(t)$  at any time can be predicted by equation (2).

$$Q(t) = \sqrt{\frac{8C}{3}KH_0^3S_y t} \quad (2)$$

Where:

$C$  – arbitrary constant;

$S_y$  – specific yield.

The report of Korean Ministry of Construction and Transportation [5] figured out several parameters which may affect inflow groundwater into subway. It conducted the research for collecting wells in some subway stations in Seoul. Parameters considered were surrounding groundwater level, depth and elevation of the collecting well, length of range, river, geological properties, etc. It showed that the volume of inflow has been correlated with the depth and elevation of collecting well. Also, the amount of rainfall has positive relationship with the volume of inflow groundwater.

### 2.2 Effect of inflow groundwater on surrounding environment

The inflow groundwater into subway tunnel could gradually decrease the groundwater level. When the groundwater level is decreased, the ground can be weakened and cavities are formed, which result in urban sinkholes. Kim investigated the causes of urban sinkhole [6]

and indicated the decreased groundwater level in urban area was one of the main cause of ground subsidence. Also, Kim recommended that most of sinkhole spots in Seoul and Pusan in South Korea were sited on the subway line, that is, subway was working as a huge Line Sink for groundwater.

Yoo and Kim investigated the relationship between groundwater flow and ground subsidence for various ground conditions by numerical approach [7]. A parametric study was conducted on the influencing factors, and indicated that tunnelling-induced groundwater drawdown causes ground-surface settlement (Figure 7).

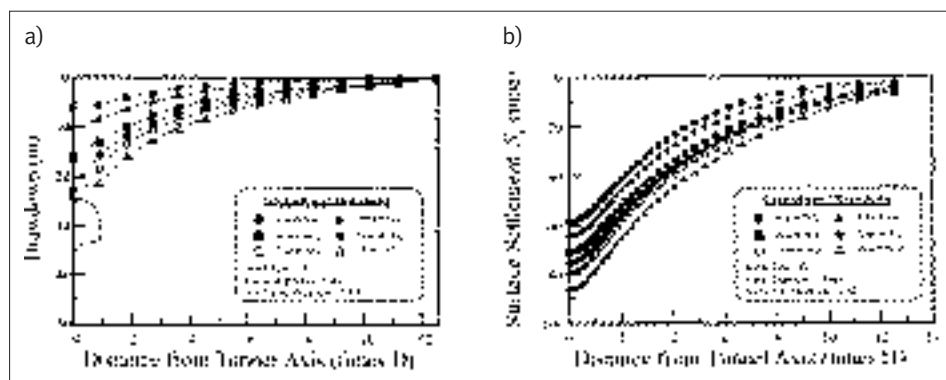


Figure 1 a) Groundwater drawdown, b) Surface settlement with groundwater drawdown [7]

The decreased groundwater level by subway tunnel also can affect the stability of its structures. Jung et al. [8] studied that lowered groundwater level could increase effective stress, which followed by ground subsidence and overstress for underground facilities.

It has been reported that subway tunnel in Shanghai in China was constructed on the weak layer of sediment. This sedimentary layer has high moisture content and compressibility and low hydraulic conductivity. According to Shen et al. [9] urbanization of Shanghai and excessive pumping of groundwater brought problems including lowered groundwater level and surface settlement, as well as the deformation of subway tunnel.

### 3 A Test-bed study on monitoring of inflow groundwater

Including Seoul, the capital, there are 6 cities which has subway system, total of 16 lines and 505 km of operational route in South Korea. According to the report by K water [10], the total amount of inflow groundwater into subway in South Korea was 142,991 m<sup>3</sup>/day, 52,193,000 m<sup>3</sup>/year. Table 2 shows the status of inflow groundwater into subway for different cities in South Korea.

Table 1 Status of inflow groundwater into subway in South Korea.

City	Line	Station	Length (km)	Inflow Groundwater [m <sup>3</sup> /day]
Seoul	8	268	287	97,308
Busan	3	92	96	15,030
Daegu	2	56	54	18,054
Inchon	1	23	24	2,719
Daegeon	1	22	23	7,920
Kwangju	1	20	21	1,960
Total	16	481	505	142,991



According to the report by Seoul city, between 1997 and 2014, the amount of inflow groundwater for line 1 to 5 of subway in Seoul has been decreased by 39.5% [11]. It assumed that the decrease of groundwater near subway has been occurred for a long time.

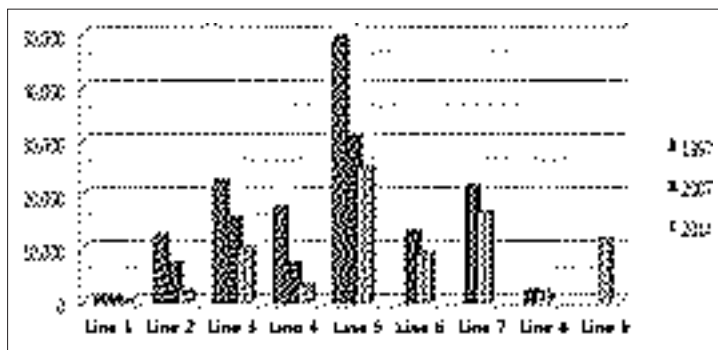


Figure 2 Changes of inflow groundwater into subway in South Korea

For the test-bed study to monitor the behaviour of inflow groundwater, one station in Daejeon city was investigated in this research. The characteristics of groundwater in collecting well such as volume of inflow, electric conductivity and temperature, etc. were measured for several months and surrounding environmental data related to rainfall, river, etc. were collected and analysed at the same period.

### 3.1 Target area for monitoring of inflow groundwater

In Daejeon city, there is 1 line of subway which is operated 22.7 km with 22 stations since 2006. Inflow groundwater is collected and discharged in 8 stations, and total amount of it is ca. 7,920 m<sup>3</sup>/day.

The target station, Jungangro station, has the largest volume of inflow groundwater in Daejeon city, which amount is 3,620 m<sup>3</sup>/day. Most of inflow groundwater has been discharged to river, and only about 16 m<sup>3</sup>/day of it has been reused. Figure 3 showed the geological properties of area near the target station. Around the station, the layer of soil was depth of 1.5~7 m for sediment, 1.5~12 m for weathering residual soil, 3.5~24.5 m for withered rock. The groundwater level was -3.9 ~ -9.8 m under the surface. The target station was excavated from 2001 to 2003, and it was reported that there was about 6.6 m ~ 15.7 m of decrease in groundwater level during the construction.

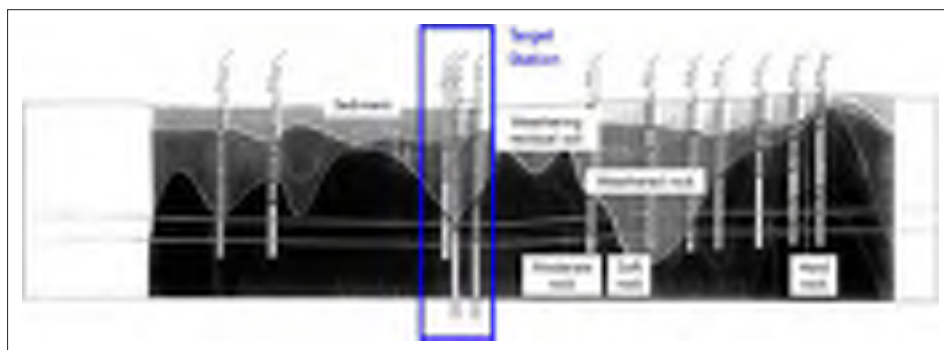


Figure 3 Geological layer of area near the target station

### 3.2 Monitoring method of inflow groundwater at test-bed station

In order to establish database for risk assessment of inflow groundwater using time series analysis, some parameters for groundwater in collecting well were measured. LTC levellogger and barologger (Solinst, USA) were installed in collecting well and in the pugging room, respectively (Figure 4).

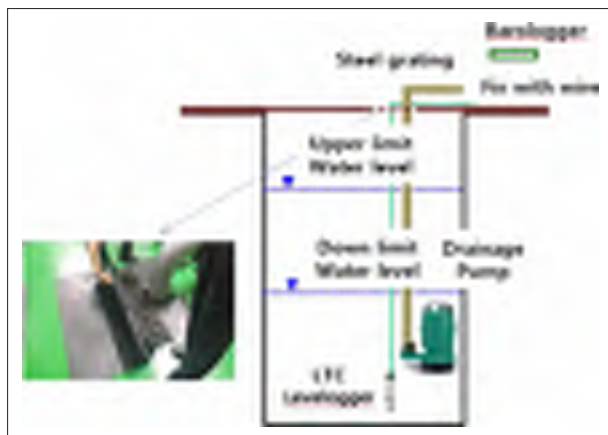


Figure 4 Installation of monitoring sensors in collected well

Using LTC levellogger, the water level in collecting well was measured every minute, which transferred to the amount of inflow groundwater by the area of well. Temperature and electric conductivity are also measured using LTC levellogger in every 3 minutes. The data of atmospheric pressure from barologger was measured to correlate the water level. The area of collecting well was 42.4 m<sup>2</sup>.

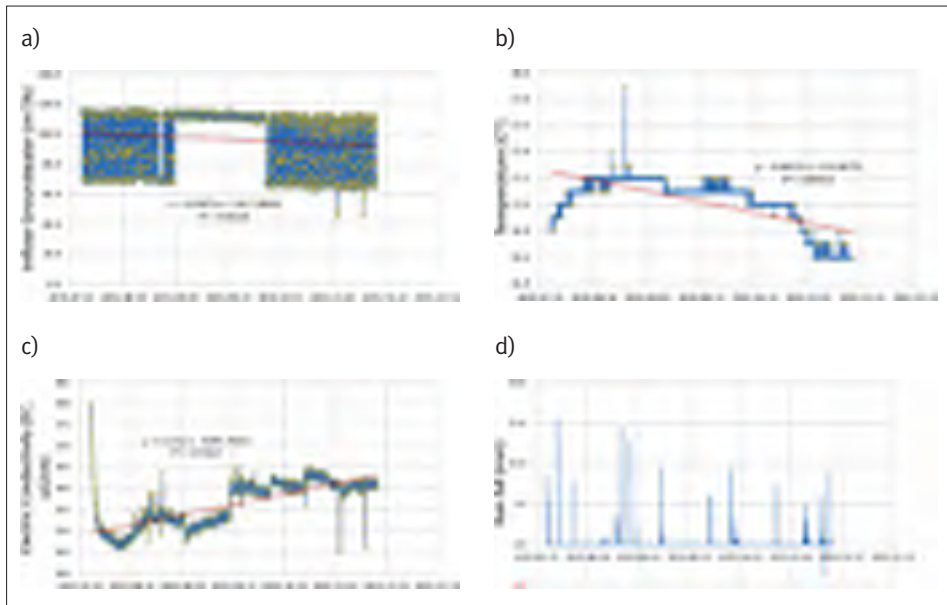
### 3.3 Results and Discussion

In order to investigate the characteristics of inflow groundwater, a test-bed station was monitored for several parameters such as the volume of inflow, water temperature, and electric conductivity, etc. Figure 5 shows the behaviour of each parameter for inflow groundwater for about 3 months. The increase of water level in collection well was ranged from 39.2 to 64.3 m/day, with average of 56.5 m/day. This meant 2,396 m<sup>3</sup>/day of groundwater was flowed into this collection well. The amount of inflow groundwater was increased during the monitoring period, which was about 2.8 m<sup>3</sup>/day. On the other hand, electrostatic conductivity was increase about 0.15 uS/cm/day, where it changed from 347 to 372 uS/cm. The factors including rainfall, river stage, and groundwater level near the station were also investigated based on the data open in public.

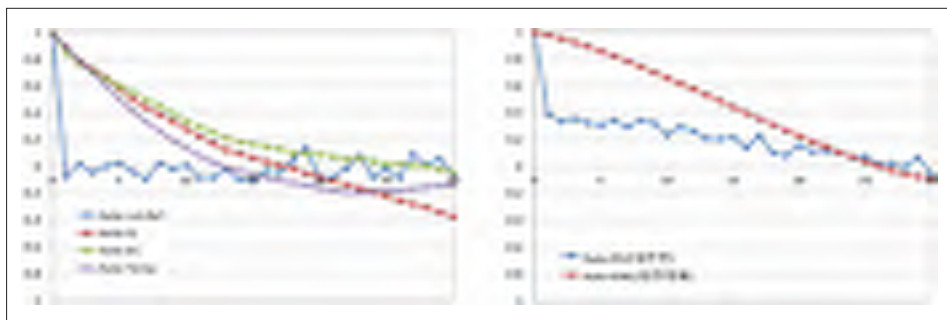
The mesured time-series data was analyzed by auto-correlation method to estimate their characteristics. Auto-correlation analysis is conducted with equation (3), where  $x_t$  is time-series data,  $k$  is time lag,  $n$  is the length of time,  $\mu$  is the average of  $x$ ,  $c_k$  is autocovariene function, and  $\gamma_k$  is auto-correlation coefficient.

$$C_k = \frac{1}{n} \sum_{t=1}^{n-k} (x_t - \mu)(x_{t+k} - \mu), \quad \gamma_k = \frac{C_k}{C_0} \quad (3)$$

In Figure 6, time-series data for 6 parameters were analysed with auto-correlation analysis. The amount of inflow groundwater, electrical conductivity, temperature and the groundwater level have auto-correlation coefficients which are decreased gradually, while rainfall, river stage shows low auto-correlation. Cross-correlation analysis was also conducted for these 6 parameters to estimate their relationship (Dara now shown). On the results, rainfall affects the level of river distinctly and EC. The amount of inflow groundwater, EC and temperature were related to each other with 7 to 14 days of time lag.



**Figure 5** Measured data for a) inflow groundwater, b) water temperature, c) electric conductivity, and d) amount of rain fall



**Figure 6** Auto-correlation analysis of inflow groundwater and surrounding factors, such as rain fall, Q(inflow groundwater), EC(electrical conductivity), temperature, RIV(river stage), and GWL(groundwater level)

## Acknowledgement

This work was supported by the National Research Council of Science & Technology (NST) grant by the Korea government (MSIP) (No. CRC-14-02-ETRI)

## References

- [1] Statistics of ground subsidence (sinkhole) in South Korea since 2005, National Disaster Management Institute in Korea, 2015.
- [2] Goodman, R.E., Moya, D.G., Van Schalkwyk, A., Javandel, I.: Ground water inflow during tunnel driving, *Engineering Geology*, 2, pp. 39-56, 1965.
- [3] Lei, S.: An analytical solution for steady flow into a tunnel, *Ground Water*, 37, pp. 23-26, 1999.
- [4] Park, K.H., Owatsiriwong, A., Lee, G.G.: Analytical solution for steady-state groundwater inflow into a drained circular tunnel in a semi-infinite aquifer: a revisit, *Tunnelling and Underground Space Technology*, 23, pp.209-209, 2008.
- [5] Korean Ministry of Construction and Transportation
- [6] Kim, J.Y.: Urban sinkhole, Causes and Solution, Soam Consultant Co., Ltd., 2001.
- [7] Yoo, C., Kim, S.: A study on ground surface settlement due to groundwater drawdown during tunnelling, *Korean Tunnelling Association*, 9, pp. 361-375, 2007.
- [8] Jung, J.S., Lee, S.G., Lee, K.Y., Jung, H.W., Kim, H.J.: A case study on the effects on underground structure due to changes in the groundwater level and ground stress, *Journal of the Korean Geoenvironmental Society*, 16, pp.13-21, 2015.
- [9] Shen, S.L., Wu, H.N.: Long term settlement behaviour of metro tunnels in the soft deposits of Shanghai, *Tunnelling and Underground Space Technology*, 40, pp.309-323, 2014.
- [10] Research report on reduction and reuse plan for discharged groundwater, K water, 2008.
- [11] Management plan of Groundwater in Seoul, Seoul city, 2015.



## 4 TRACTION VEHICLES





## EFFICIENT RAILWAY INTERIORS – EXPERIENCES

**Bernhard Rüger**

*Vienna University of Technology, Austria*

### Abstract

In order to be “competitive” as a railway, operating efficiency counts as an important imperative. In the context of railway carriage interior planning this is often made subordinate to other substantial aspects such as for example, expediency. This leads in practice to the opposite wished for result. Misunderstood operating efficiency concepts such as a maximal utilization of space for seating can in reality lead to a decline in operating efficiency, operational problems and in incidents to serious safety risks.

### 1 Introduction

The railway finds itself, especially in long-distance travel, in an area of tension between both of its competitors, road travel and air travel. People who travel by air have or at least see no alternative to air travel. This leads to an acceptance by air travellers of comfort constraints which arise due to economic pressures on the airlines. Airlines can afford to arrange the seats in the passenger cabin to achieve a maximum of seating. Since in airline travel reservations as well as the check-in of luggage are compulsory, all seats can therefore actually be used and sold. For the railway such restrictions or drastic loss of comfort are not common and are therefore seldom implemented. Depending on travel duration and distance at least half of railway passengers could use the alternative of auto or air travel. Over 50% of travellers on ÖBB long-distance trains say that they have a driving license and have an auto available at any time. Also, because airline tickets are to some extent inexpensive, the cost argument regarding this mode of transportation is often eliminated. This in turn makes air travel more attractive. The railway cannot afford to (and should not) ignore the demands and needs of travellers. In order to achieve the high proportion of railway travellers wished for in transport policy, which as a rule also actually contains economic benefits, the railway must bring into play the advantages which it has over other modes of transportation.

However, the tendency in recent years to equip vehicle interiors with the highest possible number of seats contradicts these considerations. This leads not only to a loss of comfort, which approximates the comfort level of air travel, but also in a number of ways constitutes serious operational problems. These problems are often not considered especially in the purchase of vehicles. The often applied evaluation criterion of the highest possible number of seats and thereby expected lower purchase- and operating costs per passenger is one-dimensional and therefore inadequate since it clearly contradicts reality in more ways than one. The consequences are elucidated in this paper.

Especially in long-distance train travel but also on many local routes particularly in the service of cruise ship ports and airports the volume of luggage is often underestimated and not taken seriously in sufficient measure as an influence factor on the criteria of station dwell time, achievable seat occupancy rate, comfort, customer satisfaction and ultimately safety.



## 2 Luggage volume

Type, size, weight and number of particular pieces of luggage depend substantially on the parameters of travel purpose in combination with travel duration, age, gender and present group size of the travellers.

More than ten years of intensive observation shows that the volumes of individual pieces of luggage tend to be larger. This is due to an increase in comfort during transport particularly attributable to the fitting of luggage with rollers. For example, pieces of luggage which weigh 14 kilos and are meant to be carried feel as though they are the same weight as pieces of luggage which weigh 21 kilos but are equipped with two rollers. Fifteen years ago 50% of suitcases taken along on rail travel were not equipped with rollers and therefore had to be carried. Five years ago this percentage amounted to about 5%. In the meantime, nearly 100% of suitcases, so-called trolleys, are equipped with rollers.

In accordance with the comfort enhancement provided by rollers increasingly larger pieces of luggage are being manufactured and used by travellers. This has led not only to an increase in the size of individual pieces of luggage but also to an increase in weight. Meanwhile, the tendency can be seen in luggage manufacturers to equip more and more trolleys with four wheels. As a result, in many transport situations an additional increase in comfort has been achieved. The assumption is that these pieces of luggage will be felt to be even more comfortable and in weight comparison even lighter; therefore, in the near future a further increase in luggage volume and pack weight is to be expected.

Both the increase in weight as well as in size present the rail operator with corresponding challenges. Namely, in the case of boarding the train over steps as well as the frequently necessary lifting of luggage in stowing, the rollers provide no support and accordingly increase the difficulties for travellers.

In order to construct adequate and efficient luggage storage areas, as a first step, knowledge of luggage volume in terms of type, size, weight and number of pieces per person is important. With regard to an efficient overall interior design statements on this cannot and must not be generalized. It appears that there can also be a regionally specific difference in the accompanying luggage. In particular the total volume to be reckoned with for each carriage is highly dependent on respective routes and their passenger or travel purpose mix. However, due to the existing amount of data very specific remarks can be made about this.

For example, in holiday travel on statistical average 50% of travel luggage pieces are medium and large trolleys. At the same time it can be said that on average one piece of luggage per person is taken on holiday. On short trips on statistical average each traveller takes 0.8 pieces of luggage which are 35% medium and 10% large trolleys (see Figure 1). Relevant to necessary luggage accommodation is the most exact knowledge possible of the travel purpose mix which particular vehicles in their area of operation can expect. From this the actual expected average luggage volume per person and thus the corresponding total volume per vehicle can be determined.

For air travellers who use the train for arrival an approx. 20% higher luggage volume is shown than for plain holiday train travel. This fact should be taken into account especially for all trains which eventually serve airports.

As an example of luggage volume, the average travel purpose distribution in Germany was used in a fictional carriage with 84 seats and a 100% occupancy, which led to the luggage volume represented in table 1.

On average travel days an average of 36 medium and large trolleys and 38 medium and large rucksacks or travel bags were stowed. With regard to luggage accommodation the total volume of luggage must subsequently be superimposed on the wished for or actual passenger behaviour concerning the accommodation. For example, to believe that the luggage volume can be accommodated in overhead racks is a fatal mistake. Even if the calculated luggage volume could be stored in overhead racks the majority of travellers would not use the overhead racks. This means in practice much of the luggage would be stowed disruptively (see below).

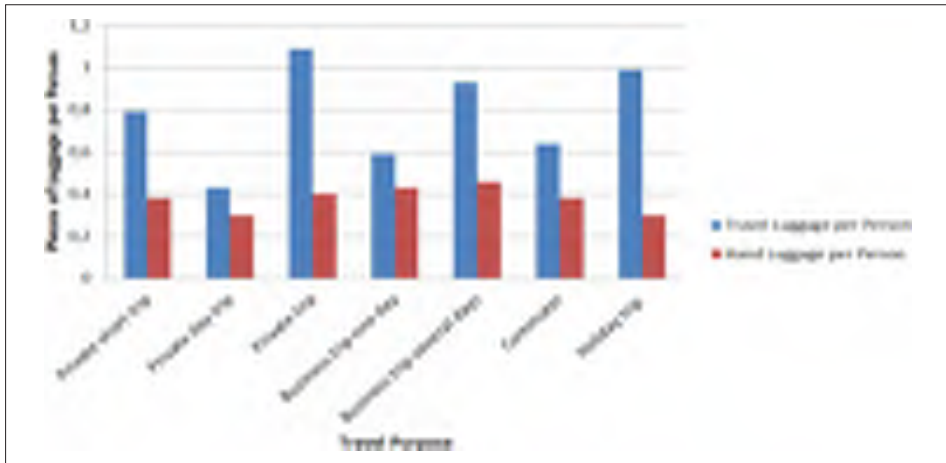


Figure 1 Average Luggage Volume per Person per Travel Purpose (Source: Plank)

Table 1 Fictional Example: Luggage volume for an average travel purpose distribution in Germany with 84 people per carriage (Source: Rüger)

Luggage type	Dimensions [cm]	Number with 84 People
Trolley large	approx. 80x50x35	13
Trolley medium	up to 70x50x30	23
Travel bag/Rucksack large	approx. 90x40x35	9
Travel bag/Rucksack medium	up to 70x35x35	29
Hand luggage	up to 55x40x25	32

### 3 Luggage accommodation

#### 3.1 Passenger behaviour

Regarding luggage accommodation there are two fundamental principles. Travellers do not want to have to lift their luggage; and for security reasons they want to have visual contact with their luggage at all times. If these two criteria are not sufficiently taken into account from the very beginning of planning, inefficient and in an “incident” quite dangerous conditions in the vehicles can be expected.

For 88% of passengers visual contact to their luggage is important or very important. This means that luggage must be able to be stowed in close proximity to the traveller. If there is no adequate possibility for this, and the luggage must be stowed at a greater distance, such as in luggage racks near the entrance, for most travellers this results in a corresponding uneasiness and loss of comfort. However, from an operational viewpoint the risk is even greater from luggage which due to a lack of visual contact has been stowed disruptively. Seventy-five percent of travellers indicate explicitly that they are prepared to stow their luggage disruptively in order to meet the need for visual contact.

As a result, luggage is placed on or in front of seats or in aisle areas. This leads to an increase in unusable seats and obstructions to passenger flow.

The second important criterion with regard to planning appropriate luggage racks is the willingness to lift luggage. For example, only 20% of travellers are prepared to lift heavy luggage into the overhead rack; over 50% are under no circumstances ready to do such lifting. With

medium sized luggage at least 50% are prepared to lift it into the overhead rack. With regard to luggage racks, at least 50% of travellers are prepared to lift heavy luggage up to waist level (see Figure 2). These specific values make it clear that it is pointless to provide overhead racks with no exception or alternative. Also, the existing number of luggage racks must be adequately dimensioned!

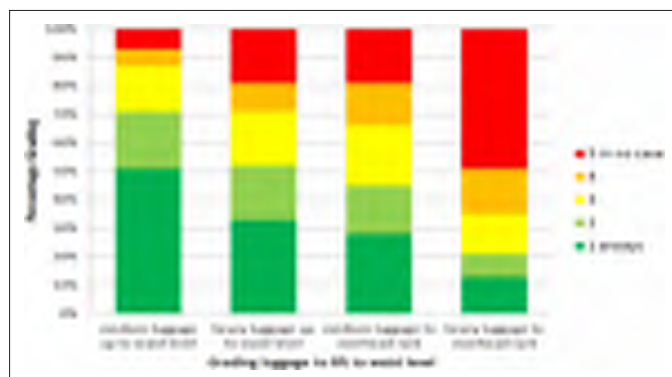


Figure 2 Readiness to Lift Luggage (Source: Plank)

The sampled readiness regarding luggage accommodation has been confirmed by extensive objective observations. Although in some cases up to 50% of the overhead racks are not used, a variety of pieces of luggage are placed on the floor, in front of seats, in the aisle or on seats. At lower occupancy rates of up to 35%, thirty percent of medium and large trolleys are placed on or in front of seats or in the aisle. Even at high occupancy rates of over 70%, by which making seats free can be expected, up to 20% of large and medium sized trolleys are placed in these positions. With rucksacks and travel bags nearly the same behaviour has been observed.

### 3.2 Possibilities for accommodation

The basic possibilities for luggage accommodation are: overhead racks, luggage racks and spaces between the seat backrests. In part, areas under the seats can also be used. However, as a rule these areas can be used only for those pieces of luggage which fall under the category of hand luggage. In order to design luggage storage space so that even with a very high occupancy rate all luggage can be properly accommodated, the following principles must be observed:

- Above mentioned principles “not lifting” and “visual contact”
- Determination of the actual luggage volume
- Reliable knowledge of the shape of the luggage

In order to efficiently design the most popular storage spaces between the seats and in the luggage racks, knowledge of the shape, size and volume of the luggage is by all means essential. Experience shows that luggage racks which are only a few centimetres, often only 5 cm to 10 cm too narrowly dimensioned, or whose shelf heights are too high or too low, can hold up to 50% less luggage than suitably dimensioned shelves!

The same applies to the space behind or between the seat backrests. Here 10 cm to 15 cm of too little usable space can lead to 70% less storage space.

In addition to the appropriate sizing of luggage racks and seat spacing, it is also important to ensure a well considered distribution of luggage storage possibilities in the vehicle. These must be distributed as evenly as possible over the vehicle to allow good visual contact to luggage from each seat and not impair the flow of passengers.

## 4 Consequences of unsuitable luggage accommodation

If the important basic principles of luggage storage space design are not respected, two serious operational consequences can be expected. The passenger boarding and deboarding time in stations will be prolonged and the actual available occupancy rate will decline up to 80%.

### 4.1 Passenger boarding and deboarding time

There are many factors which affect passenger boarding and deboarding time. These include passenger related factors which manufacturers and operators have no control over. These factors include age, gender, accompanying luggage and any kind of mobility limitation. However, the vehicle-side factors are important. On one hand, by correct planning the passenger-side factors can be correspondingly reduced; on the other hand, by improper planning these can be exacerbated. These factors include for example, the entry height and door width, potentially any existing level entrances, location and number of entrances, the suitability of entrance spaces as collection areas, any restrictions to passenger flow and the overall design of the vehicle interior.

From the perspective of passenger boarding and deboarding time the difference between the best and the worst vehicles currently in use is at a ratio of 1:4. This means in concrete terms that with an assumed passenger boarding and deboarding time of one minute in the best case, the time for the same number of passengers in the worst case can be up to four minutes! It should be noted here that with some exceptions younger generation vehicles which are currently in operation tend to produce higher values.

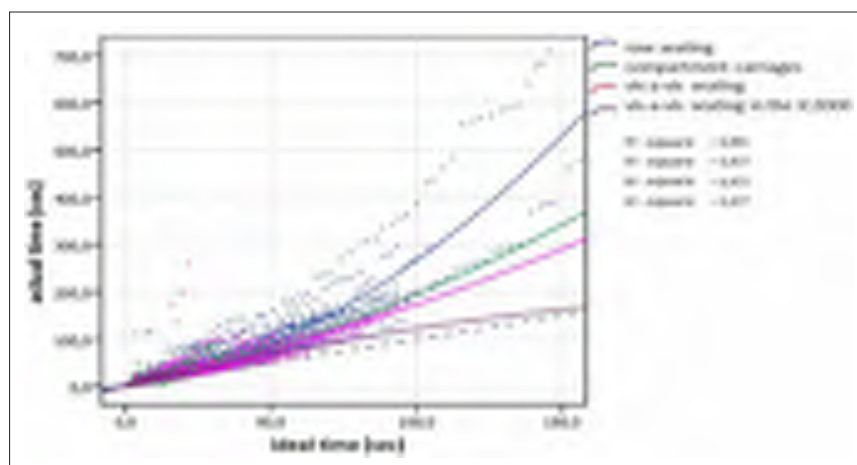


Figure 3 Time required for the boarding and deboarding process in different interior designs (Source: Tuna)

The influence of interior design between the best and worst case already produces an affect with a ratio of 1:2 (see Figure 3). This means for example, in the best case at a high rate of passenger exchange in conventional vehicle constructions, a passenger boarding and deboarding time of two minutes can be achieved. Whereas, in the worst case it requires four minutes. In Figure 3 fundamental concepts are presented; in such a way whereby in this example in row seating practically only overhead racks are available and in vis-a-vis seating luggage can be well stowed between the seat backrests. There is similar data from approximately ten basic vehicle interior categories. All findings show the clear correlation between time demand and luggage storage. The more suitable the design of luggage storage areas, the less time is needed for boarding and deboarding.

## 4.2 Occupancy rate

From an operational point of view, the second relevant effect of well planned or vice versa insufficiently thought out luggage storage areas, is the actual occupancy rate.

In long-distance traffic the only significant occupancy rate is the seat occupancy rate. With unsuitable and insufficiently designed luggage storage possibilities, even this can decline noticeably. In conventional passenger carriages with a length over buffers of 26.4 meters, a maximum of 80 seats for standard days and 78 seats for travel days are provided (see Figure 4). This number is achieved if the remaining areas are used in suitable form for luggage storage. If this is the case, up to 100% of the seats can be occupied. If there are more seats over these limits, it is at the expense of customer-oriented luggage accommodation; and the actual number of available seats as well as the occupancy rate sink drastically. Previous studies by the Research Centre for Railway Engineering at the Technical University of Vienna show that the average achievable occupancy rate in comparable vehicles with 88 seats is only about 80%. This means that on average only 70 of the 88 installed seats can be used (see Figure 4)! The reason for the sharp decline in occupancy is that there is not enough luggage accommodation capacity available and the existing areas are frequently unsuitably designed. This leads to the fact that part of the luggage is stored not only in the aisle but also on and in front of the seats.

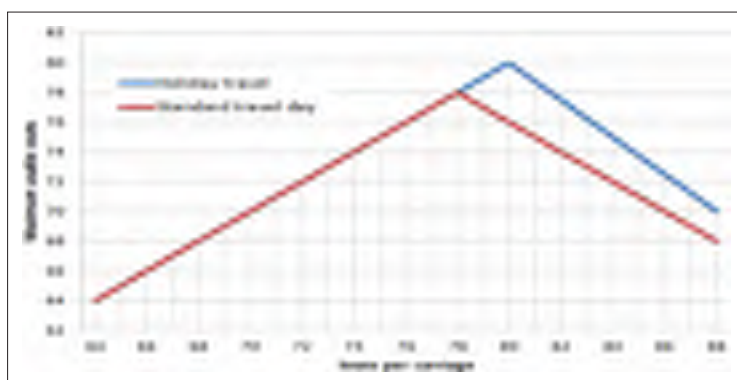


Figure 4 Maximum possible number of seats in passenger carriages with a length of 26.4 meters over buffers

## 4.3 Operating efficiency

The consequences of falsely planned luggage storage possibilities presented so far ultimately have significant operating efficiency impacts. The hope or goal to also be more efficient through a greater number of seats is transformed as a general rule into the opposite. Under the premise that the goal is to want to take advantage of the highest number of available seats, the following circumstances always prevail:

**Delays:** Vehicle interiors following the idea of seat maximization inevitably lead to long station stop times. With a high passenger exchange, four to six minutes per station are the result. Whereas, ideally designed vehicles require only one to one and a half minutes. This fact in the case of a close sequence of stations leads to corresponding delays.

**Declining operating quality:** When they cannot be made up for, the aforementioned delays lead to a decline in operating quality. This is especially important if delays are carried over to connecting or opposite trains, or if the results are missed connections.

**Higher energy consumption:** If it is at all possible to make up for the delays, it is only possible by constant use of maximum line speed, which means a significant additional energy consumption especially at a high rate of speed.

Lower occupancy rate: There are seats installed which in practice are not available. At the same time the achievable seat occupancy rate declines for 20%

Declining passenger satisfaction: The declining seat occupancy rate causes a correspondingly high number of standing passengers, which accordingly reduces passenger satisfaction. Comfort is significantly reduced by the in part “chaotic” conditions in “overcrowded” vehicles. For nearly 18% of travellers high occupancy together with the already mentioned associated effects means a high stress factor!

#### 4.4 Safety

The most important criterion which is often overlooked in insufficiently estimated operating efficiency considerations is safety. If in an emergency a train has to be evacuated, a large number of seats at a high occupancy rate in combination with the aforementioned effects presents a high safety risk. In air transportation a maximum evacuation time of 90 seconds must be proven before the certification of an aircraft. In railway transportation there are no such known provisions. However, it is understood that in most vehicles this time cannot be met. In a fully occupied carriage with 88 seats, the absolute exit time of all passengers under ideal conditions (no luggage during the exiting process, no backup because of crowding at the entrance door, only two steps) with the best carriage designs approx. 120 sec. is required and with the worst constructions, approx. 160 sec.

In an incident, rising panic must be considered in which case an orderly exiting process cannot be expected. Above all, in this case improperly stowed luggage would lead to a corresponding safety risk! For this reason alone it must be ensured that for every installed seat there is also a suitable luggage storage space.

### 5 Fundamental planning errors

From past experience, both on the part of the purchaser as well as on the part of the manufacturer, fundamental errors which lead to the inefficient conditions described above can be identified in the planning and ordering process.

**Error 1:** Volume calculation: Every cuboid-like object has a volume and also three definite dimensions. As a rule in tender documents there is only information on the total volume required for luggage accommodation. For cuboids the volume is known as the product of width, length and height. This means that an often called for volume of approx.  $0.125\text{m}^3$  per passenger can either correspond to the dimensions of a mid-sized trolley with dimensions of  $50 \times 70 \times 35$  cm, or at the same time, a trolley with dimensions of  $1 \times 4160 \times 30$  cm! Accordingly, it is also common practice to multiply every small cross-sectional area by the available depth and to sum the resulting volumes to a total volume! As a rule, in practice a maximum of 50% of the calculated volumes are available. It is therefore necessary to have precise knowledge of the statistical distribution, shape and dimensions of the luggage!

**Error 2:** Disregard of passenger behaviour: If the principles of “not lifting” and “visual contact” with regard to luggage storage construction are disregarded, the planned storage areas will be only in part accepted by the passengers. In practice this leads to the condition that up to 50% of all storage areas remain unused and yet a larger amount of luggage is stored disruptively.

**Error 3:** False awareness of luggage volume: The actual luggage volume has to be calculated for each route and expected passenger or travel purpose mix. Frequently blanket assumptions are made, or days are taken as a basis for calculation on which only a below average luggage volume can be expected.

**Error 4:** False dimensioning: Meanwhile, luggage accommodation is increasingly being taken into account in vehicles with regard to the installation of luggage racks and the space between the seat backrests. However, here it must be noted that the dimensions of luggage racks are

often oriented to seat spacing resulting in very inefficient dimensions. The same can be observed in the spaces between the seat backrests. When dimensioning the respective storage areas it is advantageous to take into account the forms and dimensions of the luggage as well as the storage behaviour of passengers. Seat spacing and luggage racks are often dimensioned a few centimetres too small, which can lead to an actual storage loss of 50% or more.

**Error 5:** False evaluation criteria for orders: In vehicle orders it can often be observed that evaluation criteria are applied which are not logically understandable. A popular evaluation criterion in tenders is to define the minimum number of seats. Usually this involves specifications which can be classified as a psychological perception; and thus, they often jump to increments of 100. If for example in the tender as a fictitious number it is predetermined that a train must have 500 seats, then the hands of the manufacturer are already bound in the tender phase; and from the outset actually efficient solutions are not possible. These figures are usually based on a previously calculated maximum number per vehicle and thereby disregard reality. With the fictitious example mentioned it can be expected that a maximum number of 450 seats will actually be available in the train. Thus, it would be much more efficient to make no such requirement, but rather to allow the manufacturers to search for efficient overall solutions. With appropriate solutions it can be expected that vehicle design concepts can be found which in the example mentioned offer approx. 470 seats. Seats, which in the end can actually be used!

## 6 Conclusion

Fifteen years of research and development as well as participation in numerous vehicle plans make it clear that at all times with vehicle development and orders an overall optimum for vehicle interiors should be sought. Many negative examples make clear that the exclusive pursuit of a maximum number of seats can in practice lead to inefficient and dangerous situations. In particular, luggage storage possibilities must be precisely and thoughtfully planned in order to contribute to efficient overall systems. Experience further shows that it is very critical to lay aside blanket assumptions about design. Each vehicle must be assessed individually in terms of attainable overall efficiency which ultimately leads to an actual maximum seating occupancy. Requirements for luggage storage must be thoughtfully formulated in the tender. Furthermore, in order to achieve the greatest possible degree of efficiency, where and which luggage storage areas can be installed must be precisely considered in the beginning phase of vehicle planning. Later changes are usually achieved only with great difficulty or with little effect. Fortunately, in recent times one can discern an awareness regarding these problems. Numerous recent projects confirm that both on the part of the operators as well as the manufacturers, interest in and willingness to develop efficient overall systems have emerged; and that some efficient overall solutions can be developed with negligible additional cost.

## References

- [1] Tuna, D.: Passenger Exchange in Passenger Transportation; TU-Vienna, Institute for Railway Engineering, Transport Economics and Cable Railways, 2008
- [2] Cis, P.: Occupancy Rate of Railway Carriages Depending on Individual Passenger Behaviour; Diploma Thesis, TU-Vienna, Institute for Railway Engineering, Transport Economics and Cable Railways, 2009
- [3] Plank, V.: Dimensioning of Luggage Storage Areas in Passenger Trains; Diploma Thesis, TU-Vienna, Institute for Railway Engineering, Transport Economics and Cable Railways, 2008
- [4] Ruger, B., Tauschitz, P., Petutschnig, B.: Boarding Assistance System Evaluation Criteria Report; Report for European Commission; Report-No. Deliverable D2.1, 2010
- [5] FLEXICOACH-AP2-Report, 2012, FFG-Tender ways2go, 4.Tender
- [6] <http://de.wikipedia.org/wiki/Evakuierungssimulation>





## PROBLEMS OF IDENTIFYING CONDUCTED DISTURBANCES IN A CURRENT DRAWN FROM A 3 kV DC CATENARY BY VEHICLES EQUIPPED WITH POWER CONVERTERS

Marcin Steczek<sup>1</sup>, Adam Szeląg<sup>2</sup>

<sup>1</sup> Łódź University of Technology, Poland

<sup>2</sup> Warsaw University of Technology, Poland

### Abstract

Prediction, identification and elimination of conducted disturbances in DC supplied traction systems still remain a vital and urgent issue. Modern electric vehicles equipped with power electronic converters are the most important source of conducted disturbances due to generation of high order current harmonics, which can cause malfunction of signalling, command and control infrastructure of a railway line. Although the problem is well reported in the literature and experienced by the manufacturers of new rolling stock which are to be put in service, previously unforeseen disturbances may appear in some cases. The authors present an idea of elimination of that kind of disturbances by applying a monitor of disturbances combined with a control system of power electronic converters of a drive system. Such a solution reduces the level of disturbances and enables the vehicle to maintain the required power and traction force.

*Keywords: electric traction, harmonics, EMC, vehicles, converters, signalling, command and control*

### 1 Introduction

In order to ensure compatible operation of rolling stock and signalling and control systems [1, 2], railway operators apply protective measures – technical and functional solutions to reduce probability of disturbances. Typically, the methods can be divided into three categories, according to the place of application:

- reduction of the level of disturbances at their source (a supply system [3, 4] or rolling stock [5, 6, 7]);
- reduction of transmission disturbances from a source to an object;
- immunization of an object.

The above could be applied at a different stage of the life cycle of the railway system infrastructure and rolling stock (design stage, construction, exploitation), which influences effectiveness and costs of the possible solution. Examples may include:

- reduction of harmonics in a DC voltage supplying catenary (increasing number of pulses of rectifiers, application of DC side filters [3, 4]);
- imposing limits of specific harmonics in current taken by rolling stock [2, 5, 6, 7] by applying bulky on-board input filters, or by using special algorithms to control traction drives [8-16];
- application of installations immune to disturbances present in railway systems [1, 2].



## 2 Description of a problem

Typically, AC low frequency track circuits (50 or 60 Hz) or similar ones, in the range of  $1.5 \div 3$  kHz or higher are used in a DC traction system. The possibility of higher harmonics currents causing malfunction of a track circuit in a range close to the operating frequency of a track circuit is a perfect example of the imminent danger from higher harmonics, which are present in return traction currents flowing in the tracks [5]. Disturbances in track circuits derive from various sources; apart from a dominant one – electric traction, these include: train heating equipment, power lines and other electrical equipment. This is the reason why so many railway management boards have introduced limits for harmonics components with defined frequency of a vehicle's current. Observance of the limits shall eliminate danger of disturbances in the track circuits. Limits for rolling stock that have been stated by Centrum Naukowo-Techniczne Kolejnictwa (Instytut Kolejnictwa-Railway Institute) in paper [7] are applicable to PKP lines. Analysis of compliance with the above-stated requirements by means of appropriate methods should be performed as early as at a design stage. Commissioning and acceptance tests of the rolling stock, which are to be performed before the rolling stock is placed into service, should confirm compliance of the above-mentioned criteria.

In case railway lines electrified in different systems – DC and AC with 50 Hz frequency are adjacent to each other, the AC system may cause significant disturbances in operation of network frequency circuits. Such phenomena have been observed in several countries, in which the lines electrified in a DC voltage system (1.5/3 kV) and 25 kV 50 Hz system [2] run in parallel. The amount of harmonics in a traction current increases with the increase of a traction substation load, as besides characteristic traction substation voltage harmonics, other harmonics caused by asymmetry of substation devices are observed. Upon introducing vehicle's converters, new harmonics appear in traction current, and their frequency results from operation of power electronic devices [3].

The paper focuses, in particular, on the issues of disturbances from traction currents and proposes to apply active on-line methods for monitoring and control of the level of disturbances generated by a vehicle, while providing traction force necessary to maintain required traction and operating parameters (acceleration, speed).

## 3 Requirements and criteria

In DC electric traction systems the most common solutions include the passive systems eliminating harmonics of current and voltage supplying a traction vehicle [2, 3]. It means that in most cases active monitoring of disturbances generated both by substations and traction vehicles is not applied. The methods used to eliminate conducted disturbances are based on passive filters selected to fit characteristics of the devices in such a manner that compatibility requirements defined by appropriate standards and guidelines [6, 7] are fulfilled at a test stage. In order to reduce possible dangers and ensure proper operation of track circuits, one normally uses a method of decreasing disturbances at their source:

- in a traction substation (psophometric voltage limits on a DC side of a substation (on Polish railway lines: 0.5%, that is 16.5 V) by use of multi-pulse rectifiers and a higher harmonics filter [3];
- in vehicles equipped with power electronic converters, in order to decrease disturbances one introduces the limits for: conducted emission – vehicle's current harmonics [4, 7] and radiated emission [1, 2]. It is recommended to apply solutions for reducing emission from energy converters: multi-level inverters, internal filters, appropriate structure of devices [2, 11], and assuring a high level of a vehicle's input impedance, which requires installation of large input filters [6, 9, 10, 12, 13, 14, 15, 16].

Furthermore, one aims at decreasing the sensibility of receivers to disturbances by: separating operating frequency of low-current devices (signalling, command and control) from

frequency of disturbances generated by traction devices [2, 5], shielding and earthing, changing operating principles and modes of the receivers [17], and eliminating the conditions for disturbances transmission [2] by: separating high-current circuits (traction) from low-power ones – signalling and control circuits (other transmission paths of various signals, appropriate distances or shielding of common areas).

## 4 Methods for identifying and eliminating possible dangers

### 4.1 Traction substation equipment

For many years now, on Polish railway lines, in 3 kV DC traction substations, which are fed with medium voltage (15, 20 or 30 kV), one has been using resonant filters (contours: for 300, 600,900 and 1200 Hz harmonics with an additional capacitor 50  $\mu$ F) and a choke of 4 mH in substations with 6-pulse rectifiers and contours for 600 and 1200 Hz harmonics with an additional capacitor of 100  $\mu$ F and a 1.8 mH choke (in substations with 12-pulse units). LC type filters (gamma type filter– with capacitance up to 0.8 mF and inductance 4-6 mH) are used in new or modernised traction substations, especially in those supplied with 110 kV voltage. These filters are more efficient than the resonant filters [3, 4] applied so far.

### 4.2 Traction substation equipment

Modern traction vehicles that are quipped with converter drive systems constitute a significant source of current harmonics that interfere with traction return current flowing in rails to a traction substation. The most common solutions for the main circuits of modern traction vehicles supplied from a 3 kV DC system include choppers supplying DC motors and voltage source inverters feeding asynchronous motors.

Vehicles equipped with choppers are usually the sources of current harmonics with constant frequency, which equals the converter operation frequency. In turn, the traction voltage source inverters operate with fluent frequency change, which causes them to generate a harmonics spectrum in an extremely wide frequency range, which, on the other hand, makes this type of a vehicle the one posing biggest threat to proper operation of a rail traffic management system [2, 6, 9, 16]. When applying a voltage source inverter with sine PWM modulation, voltage harmonics with the following frequencies appear in a motor's phase voltage:

$$f_{h1} = i \cdot f_{tr} \pm j \cdot f_{sin} \quad \text{for } i = \text{odd}; j = \text{even}; \quad (1)$$

$$f_{h2} = i \cdot f_{tr} \pm j \cdot f_{sin} \quad \text{for } i = \text{even}; j = \text{odd}; \quad (2)$$

where:

$f_{tr}$  – carrier wave frequency;

$f_{sin}$  – basic voltage component frequency.

Thus, what appear in a DC link current are two groups of harmonics. The first one includes the so-called changeable harmonics that depend on the basic frequency  $f_{sin}$ , and their most significant frequencies may be defined by a formula:

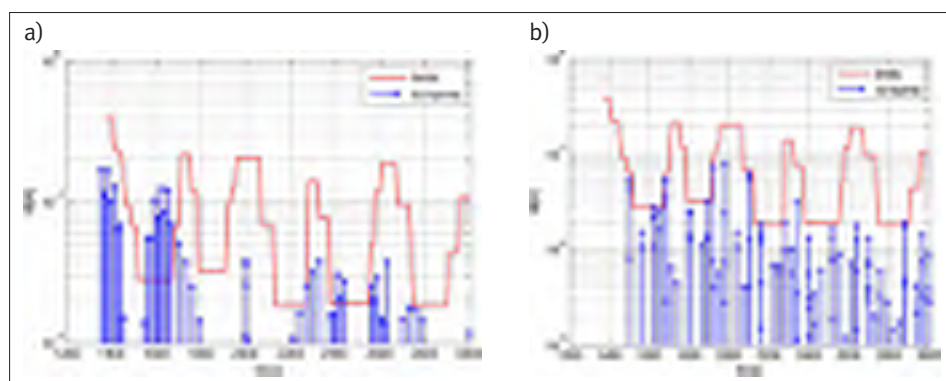
$$f_{DC1} = i \cdot f_{tr} \pm 3 \cdot f_{sin} \quad \text{for } i = \text{odd}; \quad (3)$$

Frequency of the so-called stationary harmonics depend only on even multiplicity of frequency – carrier wave  $f_{tr}$ , which can be described by the formula:

$$f_{DC2} = i \cdot f_{tr} \quad \text{for } i = \text{even}; \quad (4)$$

Example of the harmonics spectrum of traction current generated by a traction vehicle without the method of harmonics elimination with sine-triangle PWM ( $f_{\text{sin}} = 0\text{-}60\text{ Hz}$ ,  $f_{\text{tr}} = 500\text{ Hz}$ ) is shown in Fig. 1 (results of computer simulation). One can observe several instances of limit overrun [7] (red solid – limits), especially in a frequency range of 1500-1800 Hz. Therefore, it is necessary to use the methods for spectrum shaping. Methods for reducing current harmonics generated by a traction vehicle drive system can be divided by an operation mode and off-line and on-line methods. Due to the highest operating reliability, the off-line methods can be widely used on-board the traction vehicles. These methods include application of passive low-pass filters of gamma type and tuning a traction converter to the limits applicable on the routes, in which a given vehicle is to be operated. The main advantage of the solutions used within the off-line method is their reliability.

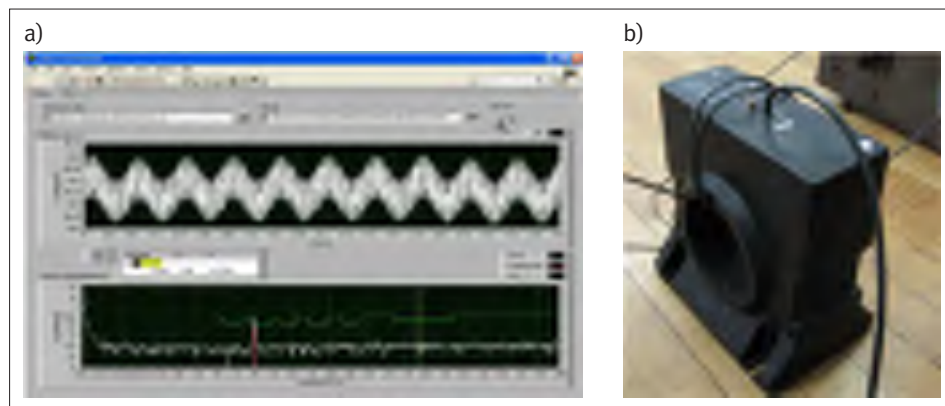
Failure of an input filter usually results in cut of power supply to a drive system, and automatic change in drive inverter modulation is not possible. The disadvantage of these types of systems is that there is a lack of possibility to adapt to the conditions that have not be foreseen by a designer at the test stage.



**Figure 1** Traction current harmonics spectrum of a) 2 MW vehicle with a sine-triangle PWM, without harmonics elimination, b) 0.5 MW drive system with application of SHE and SHR methods.

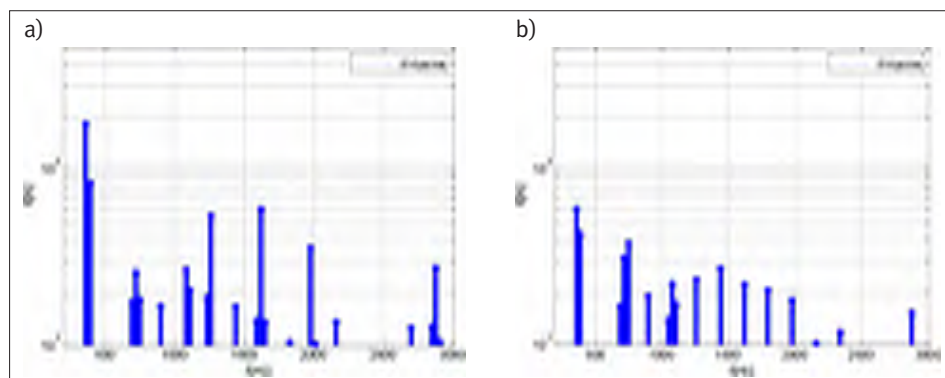
Operating conditions of a traction drive system are perceived as extremely difficult ones due to a large number of variables: change of voltage, load and a drive operating point. The large number of variables that are random in their nature, makes it difficult to adjust passive methods, which would fulfil their role under all conditions. Therefore, it is reasonable to design and develop methods based on an on-line operating principle. Such systems must rely on devices that monitor the condition of a drive system with a view to generated disturbances. When a measuring system detects that the set limits have been exceeded, it shall act so as to stop a disturbing influence of a drive system. For this type of a system to be developed, it is essential to solve two basic technical issues. At the stage of an on-line system design, one should develop a method for effective and fast detection of traction current harmonics. Fig. 2 shows selected elements of an exemplary system designed for measurement and acquisition of traction current waveforms [17]. Use of a LEM converter ensures the appropriate level of separation from a vehicle's main circuit, but at the same time it requires an output signal to be conditioned (integrating circuit). Further signal processing has been performed using application developed in a LABVIEW environment, and it allows taking into account measuring system frequency characteristics, and comparing the harmonics spectrum with the applicable limits. In real systems, the examined current waveforms very often present features characteristic for high-frequency distorted waveforms. In addition, there is a problem of signals variable frequency (start-up and braking) when the speed of a vehicle changes. All these factors can cause the methods based on the Fourier's analysis to be ineffective [18]. Another issue

consists in developing a system's response to detected disturbances. The simplest solution is to disconnect (power reduction) a drive system from a power supply system. However, this solution may pose several problems related to traffic disruptions. Such an option solves the problem of disturbance generation, but it causes a new one, namely, a traction vehicle that is on the route, but is not supplied from any source. Another solution consists in using systems generating a signal having frequency and value the same as the interfering signal, but an opposite phase, in order to enable signal compensation.



**Figure 2** The elements of a laboratory model of the system used for on-line monitoring of the harmonics in current consumed by a converter from a DC network: a) a screenshot of an application developed in the LABVIEW environment; b) LEM RA 2000-S/SP1 converter.

It seems reasonable to actively and directly influence the control strategy that is implemented by a drive voltage source inverter. One possibility is to reduce power of a drive system. Figures 3 a and b show influence of the decreased power of a vehicle on DC-link current harmonics for a selected operating point of an inverter drive system (results of computer simulation). This method allows both for reducing harmonics and maintaining supply of a drive system; however it also forces to reduce a torque, which with higher loads may influence vehicle's movement, especially dynamics at higher speeds. Its disadvantage lies in lack of control over values of particular harmonics, due to the fact that power decrease does not equally influence all current harmonics (Fig. 3).



**Figure 3** Results of simulation calculations of DC-link current harmonics generated by a 0.5 MW drive system: a) full power; b) reduced power

In this case a more favourable solution is to tune a drive system in such a manner to maintain the set torque  $T$  of traction motors for the desired speed  $\omega$ . For this purpose, the authors propose to use a SHE method (selective harmonic elimination) and its modification – SHR (selective harmonic reduction) [16]. The method allows for maintaining the value and frequency of a basic component of inverter's output voltage at a set level in conjunction with a simultaneous regulation of voltage harmonics, and hence shaping the harmonics spectrum of traction current. Fig. 1b shows a harmonics spectrum that has been determined based on a computer simulation of a 0.5 MW traction drive system using a combination of the SHE and SHR methods.

## 5 Conclusion

Application of the described methods for traction current spectrum shaping enables reaching a set speed, and thus a driving torque of vehicle's traction motors, while reducing amplitudes of DC catenary current harmonics generated by the electric traction vehicle. Such solution enables maintaining required traction parameters – tractive force developed on the wheels provide appropriate movement dynamics and the compatibility requirements are fulfilled within the set limits.

Taking into account efficiency of modern measuring signals processing systems and effectiveness (confirmed during laboratory tests and simulation) of the methods for inverter control that have been proposed by the authors to eliminate current harmonics, it seems promising to apply the described concept of a system for on-line mode operation. Operating principle of this type of a system should be based on monitoring of current consumed by a vehicle. In case one detects overrun, the system implements a control strategy that allows reducing amplitudes in a range in which the overrun was discovered. Depending on the assumption, a new control strategy may be determined in real time or loaded from the previously prepared 'map' of controllers (lookup table).

The primary advantage of this type of a system is the on-line monitoring of emission of conducted disturbances generated by a traction vehicle during operation. It significantly increases the security level on a railway line by eliminating the possibility that vehicles disturb the operation of the rail traffic management systems. However, it is required to autotest the on-board system on an ongoing basis, so to ensure reliability and its proper operation performance, and to prevent disturbances of vehicle's operation – as a result of incorrect indications and the malfunction of the system.

## References

- [1] Standard EN 50121-1:2015 Railway applications. Electromagnetic compatibility. General (2015)
- [2] Ogunsola, A., Mariscotti, A.: Electromagnetic Compatibility in Railways-Analysis and Management, ISBN: 978-3-642-30280-0, Lecture Notes in Electrical Engineering, Volume 168, 2013, SPRINGER.
- [3] Szeląg, A., Maciolek, T., Patoka, M.: Effectiveness of filters in 3 kV DC railway traction substations supplied by distorted voltage-measurements and diagnostics, ACTA IMEKO, 4, pp. 72-79, 2015
- [4] Arrillaga, J., Smith, B.: AC-DC Power System Analysis, IEE London 1998.
- [5] Białoń, A., Szeląg, A., Zając, W.: Disturbing Influence of Electric Traction Vehicles on Signalling and Control Circuit on Silesian Regional Railway (p. 222-224). International Symposium on Electromagnetic Compatibility and Electromagnetic Ecology EMC. Vol. 95., EMC 95 EME, 1995, Saint-Petersburg
- [6] EN 50388 standard- Railway applications – Power supply and rolling stock – Technical criteria for the coordination between power supply (substation) and rolling stock to achieve interoperability (2011)".

- [7] Białoń, A., Kazimierczak, A., Furman, J., Zawadka, Ł., Adamski, D., Pajka, P., Ortel, K.: Defining limits and levels of disturbances in signalling and control railway systems (in Polish), Railway Institute, Report 4430/10 for PKP PLK S.A, Warsaw, September 2011.
- [8] Lewandowski, M., Szeląg, A.: Minimizing of the output voltage of the chopper inverter, *Archiv. fur Elektrotechnik*, 69,1986, pp. 223-226.
- [9] Magzan, A., Rajkovic, B., Peric, N.: Possibilities to increase input impedance or power factor of line side converters supplied by DC or AC railway network, *Conf. Power Electronics and Variable Speed Drives*, 18 – 19 September 2000, IEE 2000.
- [10] Mellitt, B., Taufiq, J.A., Xiaoping, J.: Input impedance of chopper equipment and its significance in low-frequency track circuits, *IEE PROC.*, Vol.136, Pt. B, No. 1, 1989.
- [11] Ogawa, T., Wakao, S., Kondo, K., Terauchi, N.: Theoretical analysis of return current harmonics in the inverter-controlled DC electric car, 35th Annual IEEE Power Electronic Specialist Conference, Aachen, Germany, 2004.
- [12] Le Roux, W., Steyn, B.M.: Simulation studies of 50Hz locomotive impedance and DC substation interference sources, *Computers in Railways IX.*, WIT Press, 2004.
- [13] Steczek, M., Szeląg, A.: On-line measurements of input impedance of an electric traction vehicle supplied by DC catenary for identification and reduction of disturbances in signalling and control track circuits, 13th IMEKO TC10 Workshop on Tech. Diagnostics, Advanced measurements, June 26-27, 2014, Warsaw, Poland, pp. 140-145
- [14] Steczek, M., Szeląg, A.: Determination of parameters significant for selection of an input filter for a DC catenary supplied electric traction vehicle filter for a DC catenary supplied electric traction vehicle, *Electromotion*, pp.48-54, 1-2, 2014,
- [15] Szeląg, A., Steczek, M.: Analysis of input impedance frequency characteristic of electric vehicles with a.c. motors supplied by 3 kV DC system for reducing disturbances in signalling track circuits caused by the harmonics in the vehicle's current, *Przegląd Elektrotechniczny*, R.89, pp. 29-333a/2013.
- [16] Steczek, M., Szeląg, A.: Modification of the Selective Harmonic Elimination Method for Effective Catenary Current Harmonics Reduction, *IEEE 18th International Conference on Electrical Drives and Power Electronics EDPE 2015*, Slovakia, 21-23 September 2015, doi: 10.1109/EDPE.2015.7325327
- [17] Jaroszuk, E.: Laboratory stand for measurements of higher harmonics of traction current in catenary, B.Sc. thesis, 2011, Warsaw University of Technology, Poland
- [18] Leonowicz, Z.: Analysis of traction system time-varying signals. *Międzynarodowa Konferencja Naukowo-Techniczna "Problemy projektowania i budowy systemu zasilania kolei dużych prędkości"* Krzyżowa 19-21 listopada 2009, pp.115-122





## PRACTICAL EXPERIENCE AND IN-SERVICE VEHICLE DYNAMICS MEASUREMENTS BASED MAINTENANCE STRATEGY FOR TRAMWAYS INFRASTRUCTURE

Ákos Vinkó, Péter Bocz

*Budapest University of Technology and Economics, Department of Highway and Railway Engineering, Budapest, Hungary*

### Abstract

In the case of guided transportation systems the acting cyclical loads in track-vehicle interaction can change in wide range depending on both the type and technical state of the vehicle and the track. Due to the urban traffic-control constraints significant additional loads can be formed from the combined effects of weather conditions and driving style. The infringement of tram traffic regulation especially exceeding the speed limit or both sudden start and braking can easily cause premature degradation of the track. The intensity of addition load between the wheel and rail was estimated by wheel modal analysis, which input data are recorded by wheel-mounted accelerometers on an in-service tramcar.

*Keywords: Wheel-mounted accelerometer, Tramway track, Condition monitoring, Wheel vibrations, In-service tramcar*

### 1 Introduction

The exact knowledge of track technical state is highly important for every railway company. Nowadays there is a great variety of track measuring devices available: from track geometry recoding trolley to track recording cars. The measurement systems can be divided into two large groups depending on which part of the track-vehicle system is measured: Geometric Measuring System (GMS) and Vehicle Dynamics Measurement System (VDMS). [1] [2] [3] GMSs provide good information about the current technical state of tracks, because there is a close relation between the current geometrical deviation of track structural elements and track deterioration level.

VDMSs give information about irregular vehicle movements (vehicle dynamic behaviour), from which poor track technical state can only be concluded indirectly. Therefore only derailment safety and travel comfort features are characterized. The axlebox mounted accelerometers and forcemeters are commonly used for measuring vehicle dynamics behaviour. The irregular vehicle movement can refer to track irregularities and depending on the defect type different exciter frequency components are registered in the measured signal. There are numerous solutions in literature to detect different wavelength-track defects by using the techniques of signal processing. The localisation of recorded data is mostly identified by using GPS navigation devices or combined systems. However, there is a way to directly identify the position information without GPS by using rotating wheel mounted accelerometers [4] [5] [6], but this solution is not commonly used for condition monitoring purposes recently.

The existing solutions, which have demonstrated to be reliable, are too expensive for tramway operators currently. Therefore this paper is aimed to introduce an accelerometer based low-cost measurement system, which is mounted on in-service vehicle's wheels and ensures



the automatic detection of faulted track sections. The authors have carried out an extensive experimental activity with an instrumented city-tram on homogeneous structured track sections. The next sections describe results and the system on which tests have been performed.

## 2 Vehicle-track interaction

The dynamic interaction between vehicle and track can be described by a mass-spring system and it can be excited by failure of both track and vehicle. In order to detect rail defect or predict failure, the tram track and the vehicle should be analysed together, because the deterioration of track is a self-exciting cyclical process between the vehicle, the track and the substructure. Running through a track defect the dynamic response of different type vehicles can change in wide range due to their variant structural arrangement. Furthermore, travelling at low speed the vehicle often makes irregular oscillation, which is not caused by track defect, but also due to their own inertial mass of parts of vehicle mass-spring system. Only one old tram type was used for the test, but the comparison behaviour of different tram types will be necessary in the future.

### 2.1 Characteristics of the tramcar

The GANZ type 8 rigid-axle articulated tramcar, which does not have slip protection and torque control traction motors, was used for the test. It has a semi-automatic drum starter, which reduces the adverse results of the sudden starts. The two powered wheelsets are situated at both ends of the vehicle. The drum-brake is located on the driven wheel-sets, and the disc-brake on the not-driven wheel-sets.

### 2.2 Investigated track section

The line test was performed in operation along the Budapest tram line 49, which is one of the most frequented lines in the downtown. Along this tram line different track types can be found. The significant part of the track is grooved rail formed embedded fastening system (ERS: Embedded Rail System), but there are special track structures on sharp curves, on the bridge and on turnouts.

## 3 Measurement set-up

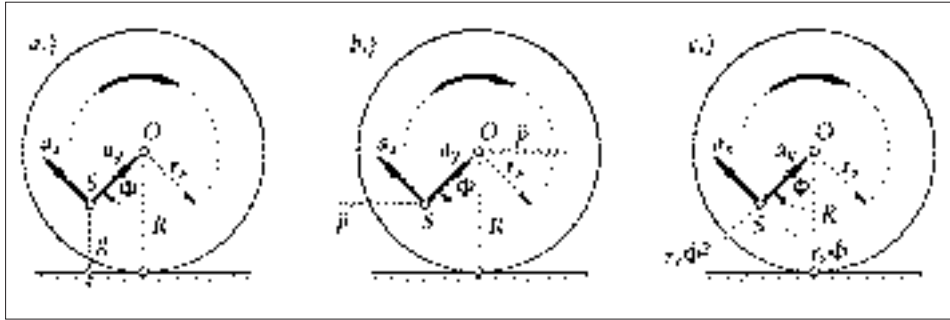
Digital USB 3-axis accelerometers have been used for vehicle dynamic measurements. Only two tools are available this time, so one accelerometer is mounted on a not-driven-wheel and another one on the driven wheel on the opposite side. The investigated conical tramway wheelset is rigid and free, so it does not have additional loads from propelling. A steel plate provides fixing accelerometers on the wheel. It has two conical structured spacers, which fit into the two bore-holes of wheel rim. These spacers expand and get stuck in the hole for torsion. The holes on the steel plate provide fixing of the accelerometers by using cable tie. The longitudinal axis of the accelerometers is perpendicular to the wheel radius, so the axis measures the  $a_x$  tangential,  $a_y$  radial and  $a_z$  lateral acceleration (see Fig. 1).

## 4 Theory & method

Dynamic accessory forces are developed by the forming acceleration during movement of the vehicle, which cause damaging vibrations of the track and vehicle components. The magnitude of forming loads can be computed by the measured data of wheel mounted accelerometers. Several independent methods were used to determine the position information, to analyse and filter the relevant frequency components of the measured signals.

#### 4.1 Kinematical model of the running wheel

The recorded acceleration data can be decomposed into four independent components: on the one hand there is an acceleration component from translational motion (0 – 5 Hz) and a sinusoid acceleration signal component caused by the gravity (5 – 10 Hz), on the other hand the accelerometer senses the radial- and tangential accelerations, when the wheel is rotating (Fig. 1). Furthermore, there is a noise component from wheel rail vibration. No slipping situation is assumed during the motion of the wheel.



**Figure 1** Sensing directions  $a_x$ ,  $a_y$ ,  $a_z$  and the kinematical model of the running wheel: a) component from the acceleration of gravity; b) component from translational acceleration; c) Radial – and tangential acceleration components from rotation

The sensed data can be computed with the superposition of the (a), (b); (c) and the remaining “noise” acceleration components:

$$\begin{aligned} a_x &= -g \sin \theta + \ddot{p} \cos \theta - \frac{r_s}{R} \ddot{\phi} + w_x, \\ a_y &= -g \cos \theta - \ddot{p} \sin \theta - \frac{r_s}{R^2} \dot{\phi}^2 + w_y \end{aligned} \quad (1)$$

where  $\theta$  is the angle of rotation;  $g$  is the acceleration of gravity [ $m/s^2$ ];  $r_s$  is the radius of inertial sensor on the wheel [ $m$ ];  $R$  is the wheel radius [ $m$ ];  $p$  is the travelled distance [ $m$ ];  $w_x$  and  $w_y$  are noise [ $m/s^2$ ];  $a_x$  and  $a_y$  are the sensig axes of the accelerometer [ $m/s^2$ ]. Figure 2 shows the above mentioned components of the sensed signal on running wheel  $a_y$  axis.

In contrast to traditional filtering methods only the known Signal components (See Fig. 1 (a) (b) (c)) are filtered, so the outstanding values of the residual component can refer to forming additional loads between the wheel and rail. Therefore the modal analyses of measured signals will be present in the next section.

#### 4.2 Modal analyses of the wheel-rail vibration

The residual vibration accelerations ( $w_x$ ,  $w_y$ ) on x and y sensing axes are determined by filtering the known component of the recorded signals. These consist of the vibration of the wheel-rail interaction and the impact of forming additional loads too (Fig. 3). Decomposing of the residual acceleration component the additional loads can be separated from the wheel-rail vibrations. Running on track defect gives a broad band excitation at the wheel [7], which means an outstanding value in the residual noise components, as well as this causes a vertical line in its spectrogram around the location of track defect (Fig. 3c). In any other cases there is a low- (Fig. 3a) or “high”-frequency vibration (Fig. 3b) of the vehicle track interaction. There are several methods to analyse the frequency components of a time domain signals.

The Short-Time Fourier Transform (STFT) allows to determine the power of frequency components of a signal by using Fourier Transform. In the function of time and frequency the power (PSD) of coherent values can be represented on a spectrogram Fig. 3. Due to the sampling frequency of the applied sensors being 400 Hz, the power spectrum can be accurately determined until 200 Hz (Nyquist–Shannon sampling theorem [8] [9]).

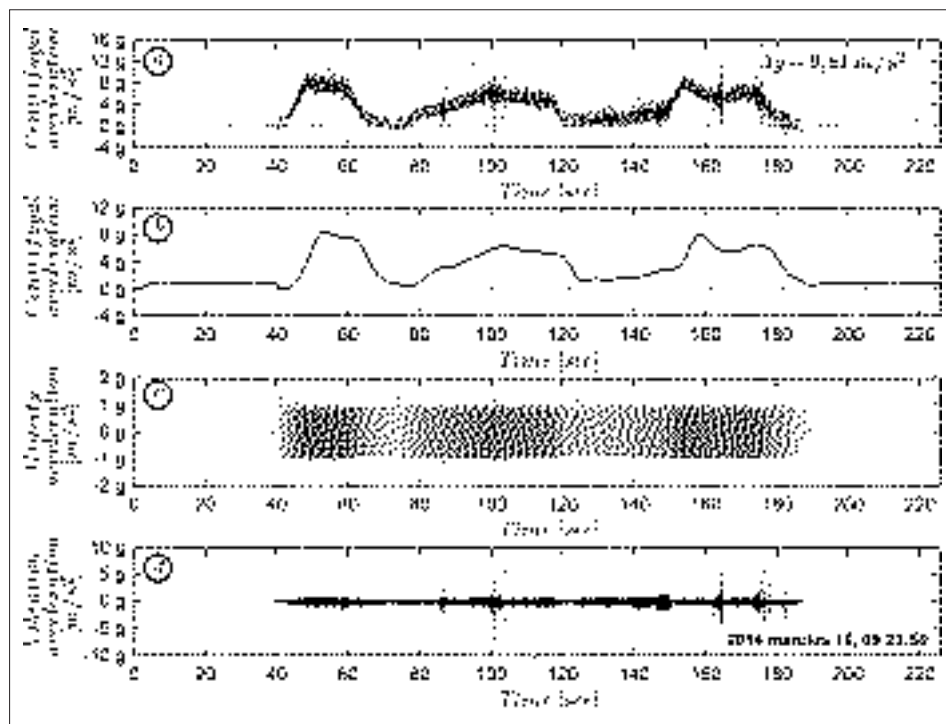


Figure 2 Extraction of the sensed signal on running wheel  $a_y$  axis: a) Measured centrifugal acceleration; b) centrifugal acceleration without its gravity component; c) gravity acceleration components; d) “noise” (vibration acceleration)

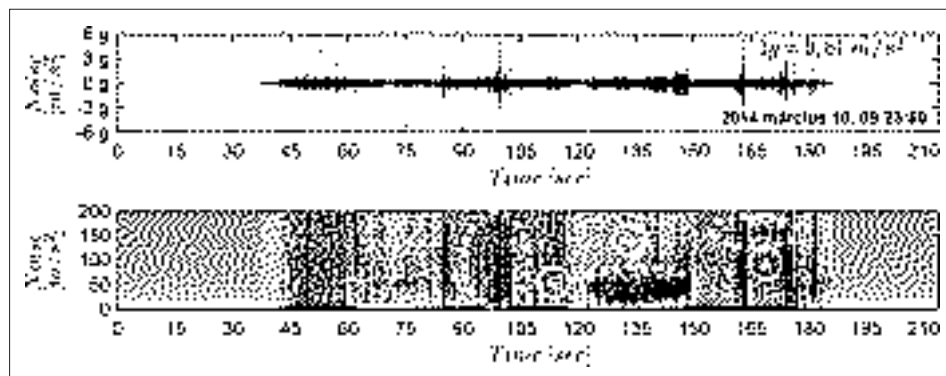


Figure 3 Dominant frequencies at place of the outstanding values of “noise”  $w_y$ : a) 150-200 Hz; b) 0-50 Hz; c) 0-200 Hz

### 4.3 Localization

Localization of outstanding values can be achieved by data of wheel mounted accelerometers. One way is the Extended Kalman Filter (EKF), which [5] in the case of an appropriate chosen physical model is suitable to compute not measured vehicle parameters from the measured data ( $a_x$ ,  $a_y$ ). It should be noted, when the forming accelerations exceed the range of the sensors, the EKF is not applicable. The next way is to compute both the rotated angle and revolution [4]. After applying low pass filter (5 Hz) or moving average on y and x axes to remove signal from gravity ( $a_{gy}$  and  $a_{gx}$ ) (see. Fig. 2c), the rotated angle can be computed by using these components, because they are sinusoid signals with constant g amplitude and the  $\omega$  angular velocity of wheel. The rotated angle is computed by using this formula:

$$\theta_{\text{angle}} = \arctan\left(\frac{a_{gy}}{a_{gx}}\right) \quad (2)$$

Where  $\theta_{\text{angle}}$  rotated angle [rad],  $a_{gy}$  gravity component on y axis [ $m/s^2$ ],  $a_{gx}$  gravity component on x axis [ $m/s^2$ ].

The travelled distance can be computed by sampling the revolutions based on rotated angle. Figure 4 shows the measured accelerations on both x and y axes, the computed rotated angle as well as the travelled distance. In the case of travelled route calculation the real wheel diameter is taken into account. The accuracy of the computed position information is between about 2 and 5 m thanks to the poor riding quality of the investigated tramcar. There is a significant sudden irregular vehicle movement at every start and stop, which causes that the first and last revolution of the rotating wheel can't be detected between two stops. The vehicle velocity is computed from the travelled route by derivation.

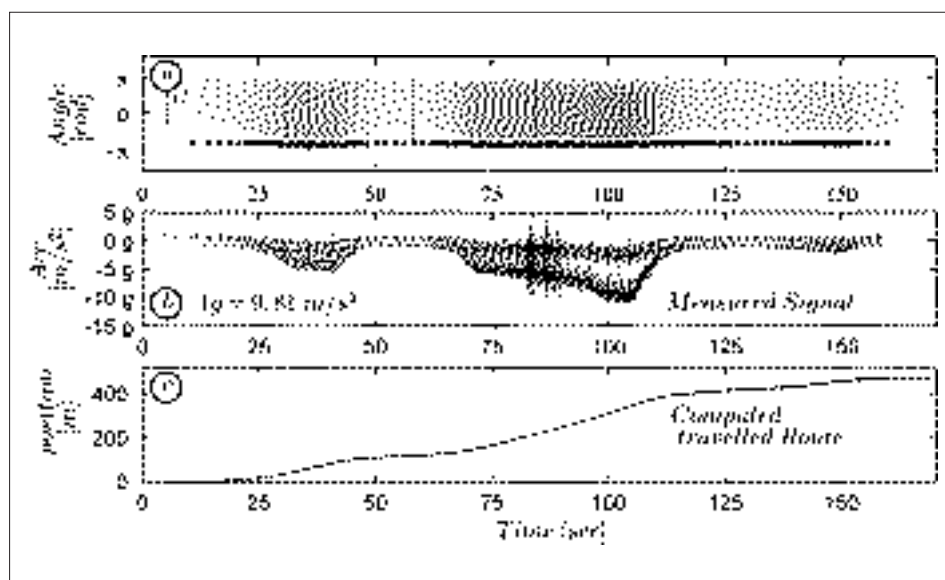
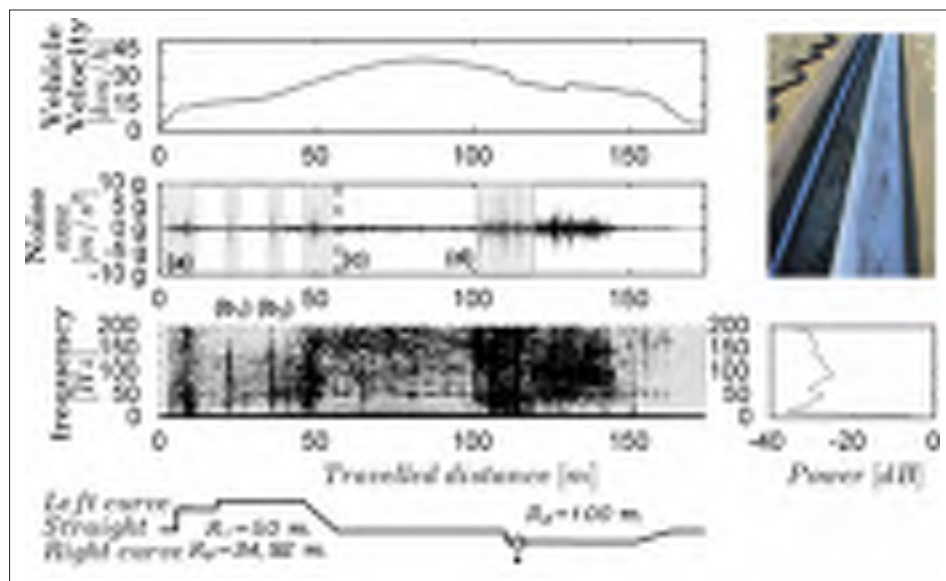


Figure 4 Position information: a) Computed rotated angle with the identified revolutions; b) Sensed data on x and y axes; c) Computed travelled route by sampling revolutions

## 5 Measurement results

During the line tests the instrumented tramcar travelled about 10 km along the tramline 49 in Budapest. In contrast to the previous section, the power spectrum of the measured signals is represented in the function of travelled route. Figure 5 is composed of 5 diagrams: In the first one the vehicle velocity [km/h] is represented in the function of travelled route, in the second one there is residual acceleration after decomposition on different sensing axes, in the third diagram the spectrogram of signal is reported, in the fourth one there is average power of frequency domain signal along the whole travelled



**Figure 5** Investigated track section between Szent Gellért Square and Kelenhegyi Street, along the tram line 49 in Budapest. (running wheel acceleration on the rim in axial direction).

section. In the last diagram the curvature of the line section alignment is represented. This information cannot be identified from the measured signal, but adding to the diagram makes it possible to analyse the recorded data easily. Furthermore, specific points of the turnouts and crossings are signed by \* on the curvature diagram.

Figure 5 shows an about 170 m long investigated track section. After the instrumented tramcar started, it travelled on a diverging track of turnout, then ran on a 34 m radius curve section, afterwards went on a straight section for about 50 m. And then meanwhile it was running on a left-sided 100 m radius curve section, it travelled through a crossing too. The residual noise component can refer to poor track technical state and the existing structural element of the track too (turnouts, crossings). The outstanding values at position (a) are recorded at travelling through crossing and switch part of the turnout. The outstanding values at (b<sub>1</sub>) and (b<sub>2</sub>) refer to two failed rail weldings. On the travelled route section between 15 and 50 there are significant corrugations on both rail running surfaces, which result in periodical vertical lines in spectrogram of the measured signal during the whole curved section. Before and after the 55 m position information there are two different sub-structures. On Figure 5 the differences in both elastic features and vibration-absorbing capability of the two sub-structures can be seen clearly, because after 50 m chainage the high-frequency-components (over 100 Hz) are more powerful than in the previous section. At the position of approximately 110 m, when the tram travelled through a crossing, there is significant broad band excitation, lasting for about

10 m. In this section the average power spectrum of the measured signal has two peaks: one of them is at 50 Hz and the other one is at about 100 Hz. The 50 Hz component dominates at curved sections mainly, while the 100 Hz component is significant, when the tram braked intensively. The statements above are also true in the case of both radial and lateral accelerations. It is important to note that the average power spectrum of lateral acceleration (sensed on z axis) is significantly higher (about twice) than the power of the accelerations recorded on x and y axes ( $a_x$ ,  $a_y$ ).

## 6 Conclusion

It can be stated that the introduced measurement set-up is suitable to detect poor technical state track section. Besides its low cost, another important advantage of this system is that the travelled route can be determined from the measured signal directly due to the existing gravity acceleration, which causes the sensors to be able to work as a revolution counter. The accuracy of travelled distance is from 2 to 5 m in 300 m, which is enough for track inspectors to find the location of the track defect. It should be noted that the using same velocity during measurement is absolutely necessary for comparison of monitored results in the case of the same track sections.

## References

- [1] Weston, P., Roberts, C., Yeo, G., Stewart, E.: Perspectives on railway track geometry condition monitoring from in-service railway vehicles, *Vehicle System Dynamics, International Journal of Vehicle Mechanics and Mobility* 53 (2015) 7, pp. 1063–1091, doi: 10.1080/00423114.2015.1034730
- [2] Hitoshi, T., Yasukuni, N., Akira, M., Takeshi, M., Hirotaka, M.: Condition monitoring of railway track using in-service vehicle, *Journal of Mechanical Systems for Transportation and Logistics* 3 (2010) 1, pp. 154–165, doi: 10.1299/jmtl.3.154
- [3] Boccione, M., Caprioli, A., Cigada, A., Collina A.: A measurement system for quick rail inspection and effective track maintenance strategy, *Mechanical Systems and Signal Processing* 21 (2007) 3, pp. 1242-1254, doi: 10.1016/j.ymssp.2006.02.007.
- [4] Huang, J., Wang, T.: Accelerometer Based Wireless Wheel Rotating Sensor For Navigation Usage, 2011 5<sup>th</sup> International Conference on Sensing Technology, Palmerston North, pp. 565-568, 2011.
- [5] Bernd, G., Udo, F.: A Kalman-filter for odometry using a wheel mounted inertial sensor, 10<sup>th</sup> International Conference on Informatics in Control, Automation and Robotics, Reykjavík, pp. 388–395, 2013.
- [6] Sonenblum, S. E., Sprigle, S., Caspall, J., Lopez, R.: Validation of an accelerometer-based method to measure the use of manual wheelchairs, *Medical Engineering & Physics* 34 (2012) 6, pp. 781-786, doi: 10.1016/j.medengphy.2012.05.009.
- [7] Corradi, R., Crosio, P., Manzoni, S., Squicciarini, G.: Experimental investigation on squeal noise in tramway sharp curves, 8<sup>th</sup> International Conference on Structural Dynamics, Leuven, pp. 3214-3221, 2011.
- [8] Shannon, C. E.: Communication in the presence of noise, *Proc. IRE* 37 (1949) 1, pp. 10–21
- [9] Nyquist, H.: Certain topics in telegraph transmission theory, *AIEE Trans.* 47 (1928), pp. 617-644





## POWER CONTROL ALGORITHM OF HYBRID ENERGY STORAGE SYSTEM FOR VEHICULAR APPLICATIONS

Maciej Wiczorek, Mirosław Lewandowski

*Warsaw University of Technology, Institute of Electrical Machines,  
Electric Traction Division, Poland*

### Abstract

In the paper, a new power control algorithm for hybrid energy storage system (HESS) is proposed. The algorithm is dedicated for vehicular applications. The aim is to enable connecting any number of energy storage devices or generators to the system and providing universal input for energy management strategy. Described system is based on multiple converter configuration with all devices connected to one DC link. Half-bridge DC/DC converters are used to interface between device and DC link. Theoretical analysis and simulations for the system composed of lithium-ion batteries, supercapacitors and photovoltaic panel were carried out.

### 1 Introduction

Energy storage systems (ESS) are becoming one of the most important elements that improve overall performance of applications ranging from power supply system and electric vehicles all the way to mobile electronic devices. ESS used in traction system allow redistribution of regenerative braking energy and support catenary during voltage decrease [1]. In power system ESS with a power of approximately MW are used to equalize the load and improve power quality [2]. Research and development of electrochemical batteries, especially lithium-ion (li-ion) technology, indicate the possibility to increase specific energy, which now is approximately 200 Wh/kg, by 300%. Nevertheless, they are not able to match fossil fuels (diesel – 13000Wh / kg). Instead they become a serious alternative for vehicles operating in big cities, where range is not priority, or, in case of restrictions on access to the oil supply and in an era of rapid climate change. Currently available ESS have several limitations regarding not only specific energy but also specific power, cycle life, price etc. Using the multitude of technologies currently available on the market and the differences in the characteristics of different types of ESS, it is possible to create a hybrid energy storage system (HESS). HESS is a combination of two or more types of trays in one system. This solution allows to use the advantages of the various energy storage devices in a single system.

There are a lot of connection configurations of a HESS described in a literature [3], [4]. In electric vehicles the most often proposed HESS is arrangement of a li-ion battery and a supercapacitor. This is justified by high specific power and cycle life of a supercapacitor on one side and high specific energy of a li-ion battery on the other. The battery is used as main energy source for the vehicle and the supercapacitor provides peak power during acceleration and regenerative braking.

The constantly growing number of vehicles and the dynamic development in the field of photovoltaic leads us to propose the use of vehicles surface as distributed sources of renewable energy. This approach can significantly contribute to increasing the efficiency of energy conversion by vehicles and to reduce air pollution in urban areas. Currently, it is also considered the use photovoltaic (PV) panels in charging stations for electric vehicles [5].



To allow for a power control of each device and connection of additional devices we selected a configuration in which all the sources are connected to one DC link. The paper focuses on the power control algorithm that allows connection of any number of devices to the system and input for energy management strategy. The simulation study was conducted for HESS consisting of li-ion battery, supercapacitor and PV panel.

## 2 HESS model

The scheme of the simulated HESS is presented in Figure 1. The devices models – supercapacitor, li-ion battery and PV panel – are connected to the DC link (DC link capacitor  $C_{DC} = 100 \text{ mF}$ ) with half-bridge, IGBT, buck-boost converters. The current smoothing inductances  $L1 = L2 = L3 = 5 \text{ mH}$  are connected in series to devices. The load was modeled as controlled current source.

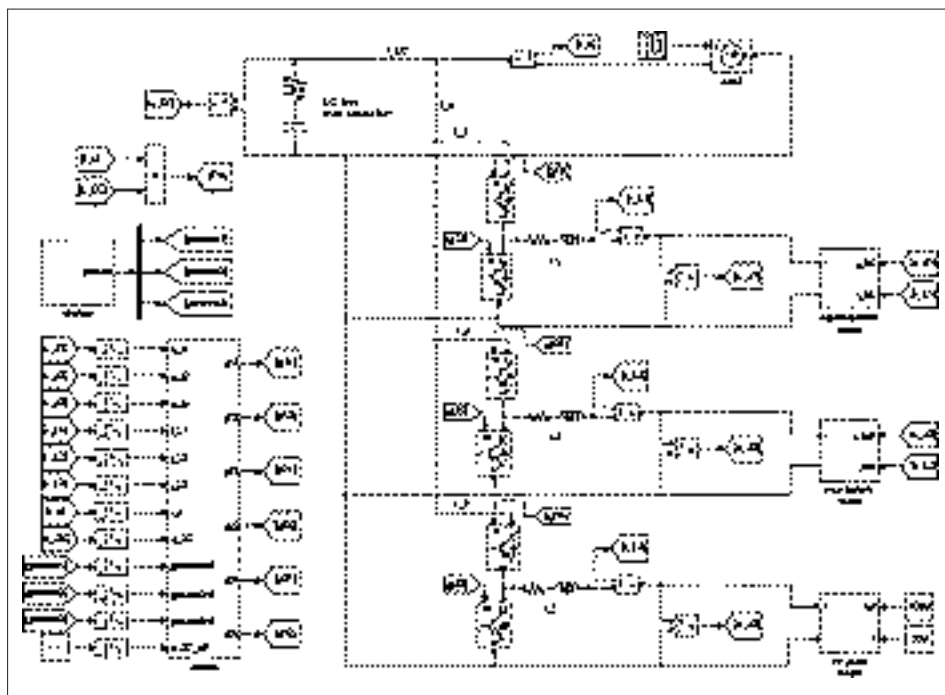


Figure 1 Scheme of the studied HESS.

In the Figure 2 the power control loop, which is placed in the control block in Figure 1, is presented. The system is designed to keep fixed controlled voltage on DC link. Using the measurements of devices currents  $i_{L1}$ ,  $i_{L2}$ ,  $i_{L3}$ , devices voltages  $u_{Z1}$ ,  $i_{Z2}$ ,  $i_{Z3}$ , DC link voltage  $u_{DC}$ , load current  $i_o$  and reference values of DC link voltage  $u_{DC\_ref}$  and power split coefficients  $\gamma_{1ref}$ ,  $\gamma_{2ref}$ ,  $\gamma_{3ref}$  the control system is obtaining the modulation coefficients references  $m_{1\_ref}$ ,  $m_{2\_ref}$ ,  $m_{3\_ref}$  for each DC/DC converter. Those references are than used in PWM generators. The power of each device is described by (1).

$$\begin{aligned}
 P_1 &= \gamma_{1ref} \cdot P_o \\
 P_2 &= \gamma_{2ref} \cdot P_o \\
 P_3 &= \gamma_{3ref} \cdot P_o
 \end{aligned}
 \tag{1}$$

Where  $P_0$  denotes load power. Therefore, defining the energy management strategy comes down to defining the values of  $\gamma_{1ref}$ ,  $\gamma_{2ref}$ ,  $\gamma_{3ref}$ , which sum should be always equal to 1 to meet power demand and keep fixed DC link voltage.

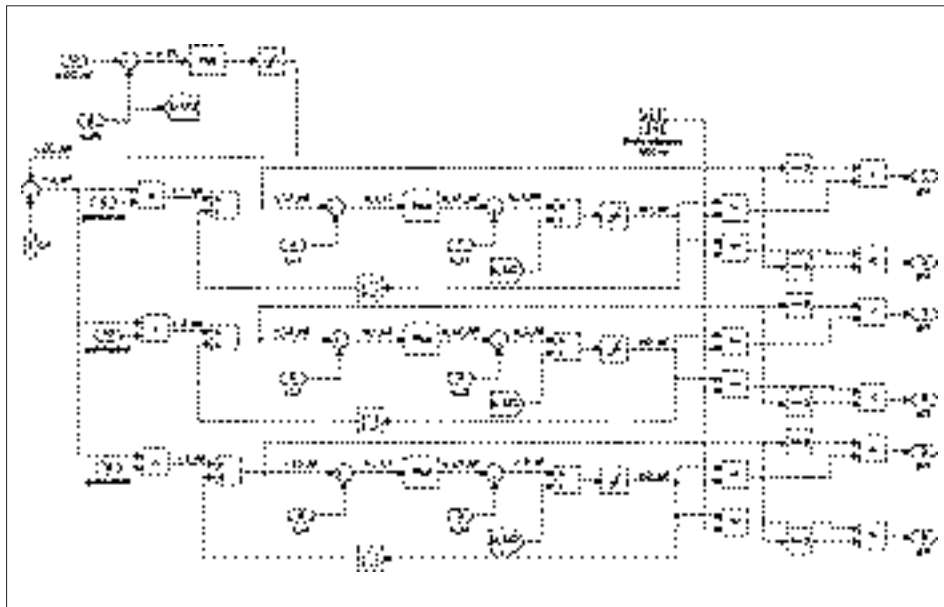


Figure 2 Scheme of the power control system.

### 3 Devices models

The scheme of the supercapacitor model used in the study was presented in Figure 3b, where  $C_{sc}$  and  $R_{s,sc}$  are respectively the capacity and equivalent series resistance of the element. The li-ion battery model was adopted basing on [6]. The scheme of the battery is shown in Figure 3a. It consists of controlled voltage source which variable is state of energy of the battery and series resistance  $R_{s,batt}$ . The last modeled device is PV panel. In the study the simulation model developed in [7] was adopted. The panel equivalent circuit is shown in Figure 3c. The parameters of the devices used in the analysis were given in Table 1.

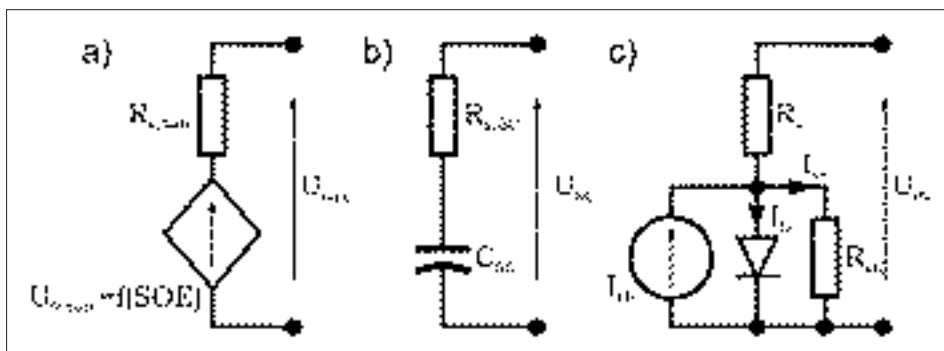


Figure 3 Equivalent circuit of a) the li-ion battery, b) the supercapacitor and c) the PV panel.

**Table 1** Devices parameters.

	Parameter	Value	Unit
supercapacitor	Nominal voltage $U_{N\_SC}$	48	V
	Series resistance $R_{s\_SC}$	6	mΩ
	Capacity $C_{SC}$	165	F
	Maximum constant current $I_{N\_SC}$	130	A
	Mass $M_{SC}$	14.2	Kg
li-ion battery	Nominal voltage $U_{N\_batt}$	48	V
	Capacity	60	Ah
	Series resistance $R_{s\_batt}$	55	mΩ
	Nominal power $P_{N\_batt}$	4,5	kW
	Mass $M_{batt}$	124	kg
PV panel	Open circuit voltage $U_{oc\_PV}$	48	V
	Nominal power $P_{N\_PV}$	120	W
	Radiation	1000	W/m <sup>2</sup>
	Temperature	300	K

## 4 Energy management strategy

There are number of energy management strategies for HESS described in literature. Some of the most interesting were presented in [3], [8], [9]. In this study focused on the control algorithm we proposed simple strategy described in Table 2.

**Table 2** Vehicle operation modes.

	CONDITIONS	SUPER-CAPACITOR	LI-ION BATTERY	PV PANEL	mode
standstill	$SOE_{SC} = *$ $SOE_{batt} < 1$ $v = 0; a = 0; P_0 = 0$	$\gamma_{1ref} = 0$ $i_{1\_ref} = 0$	$\gamma_{2ref} = 0$ $i_{2\_ref} = -i_{3\_ref}$	$\gamma_{3ref} = 0$ $i_{3\_ref} = P_{PVmax}/U_{DC}$	1
	$SOE_{SC} < 1$ $SOE_{batt} > 0$ $v = 0; a = 0; P_0 > 0$	$\gamma_{1ref} = 1$ – $\gamma_{2ref}$ – $\gamma_{3ref}$	$\gamma_{2ref} = P_{batt\_limit}/P_0$	$\gamma_{3ref} = P_{PVmax}/P_0$	2
acceleration	$SOE_{SC} > 0$ $SOE_{batt} > 0$ $v > 0; a > 0$ $P_0 > P_{batt\_limit}$	$\gamma_{1ref} = 1$ – $\gamma_{2ref}$ – $\gamma_{3ref}$	$\gamma_{2ref} = P_{batt\_limit}/P_0$ – $\gamma_{3ref}$	$\gamma_{3ref} = P_{PVmax}/P_0$	3
	$SOE_{SC} = *$ $SOE_{batt} > 0$ $v > 0; a > 0$ $P_0 \leq P_{batt\_limit}$	$\gamma_{1ref} = 0$	$\gamma_{2ref} = 1$ – $\gamma_{3ref}$	$\gamma_{3ref} = P_{PVmax}/P_0$	4
constant speed	$SOE_{SC} = *$ $SOE_{batt} > 0$ $v > 0; a = 0$ $P_0 \leq P_{batt\_limit}$	$\gamma_{1ref} = 0$	$\gamma_{2ref} = 1$ – $\gamma_{3ref}$	$\gamma_{3ref} = P_{PVmax}/P_0$	5
regenerative braking	$SOE_{SC} < 1$ $SOE_{batt} = *$ $v > 0; a < 0; P_0 < 0$	$\gamma_{1ref} = 1$	$\gamma_{2ref} =$ – $\gamma_{3ref}$	$\gamma_{3ref} = P_{PVmax}/P_0$	6
	$SOE_{SC} = 1$ $SOE_{batt} < 1$ $v > 0; a < 0; P_0 < 0$	$\gamma_{1ref} = 0$	$\gamma_{2ref} = 1$ – $\gamma_{3ref}$	$\gamma_{3ref} = P_{PVmax}/P_0$	7

\*Any value

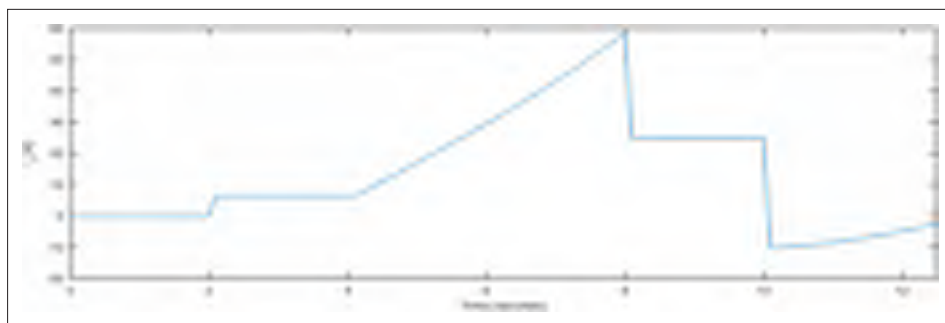
The gamma coefficients depend on current state of the vehicle, where  $v$  denotes vehicle's velocity and  $a$  its acceleration, and state of the energy of the supercapacitor  $SOE_{sc}$  and the battery  $SOE_{batt}$ . The PV panel power should be as high as possible regardless of the vehicle conditions. Due to that, the panel is equipped in maximum power point tracking (MPPT) system. In Table 2, seven possible modes of HESS operation were specified.

## 5 Results and discussion

The operation of the proposed system was verified on the example of an electric car, which parameters are given in Table 3. The car performs theoretical drive cycle that allows to examine all HESS operation modes. The load current during the cycle is shown in Figure 4.

**Table 3** Vehicle parameters.

Parameter	value	Unit
Mass $M$	1500	kg
Drag coefficient $C_x$	0.4	–
Frontal area $A$	4	$m^2$
Rolling resistance coefficient I $C_0$	0.008	–
Rolling resistance coefficient II $C_1$	$6 \cdot 10^{-6}$	$(s/m)^2$
Power train efficiency $\eta_d$	0.8	–
Air density $\rho$	1	$kg/m^3$



**Figure 4** Load current plot.

The programmed strategy was correctly executed by the control system (Figure 5). In mode 1 the battery is charged by PV panel. Next, in mode 2, while the load power is greater than zero due to the car's auxiliary power (assumed 500W), which means that the car will be accelerating soon, the battery and PV panel are charging the supercapacitor. During an acceleration the battery is covering the power demand to the previously set limit  $P_{batt\_limit}$ . The power that exceeds the limit is covered from supercapacitor (modes 3 and 4). At the same time the PV panel power is added to storage devices power. While the car is driving with constant speed the power demand is fully covered from battery and PV panel (mode 5). During a regenerative braking whole energy is gathered by supercapacitor, while it is also charges from PV panel (mode 6). The 12V overvoltage can be noticed while switching from mode 5 to 6. It is caused by fast change of the load current. The load current is dropping but the devices currents are still higher as the controller did not react yet, so the DC capacitor is charged by devices currents. If the supercapacitor is fully charged the whole braking energy is gathered by battery while is also charged by PV panel (mode 7).

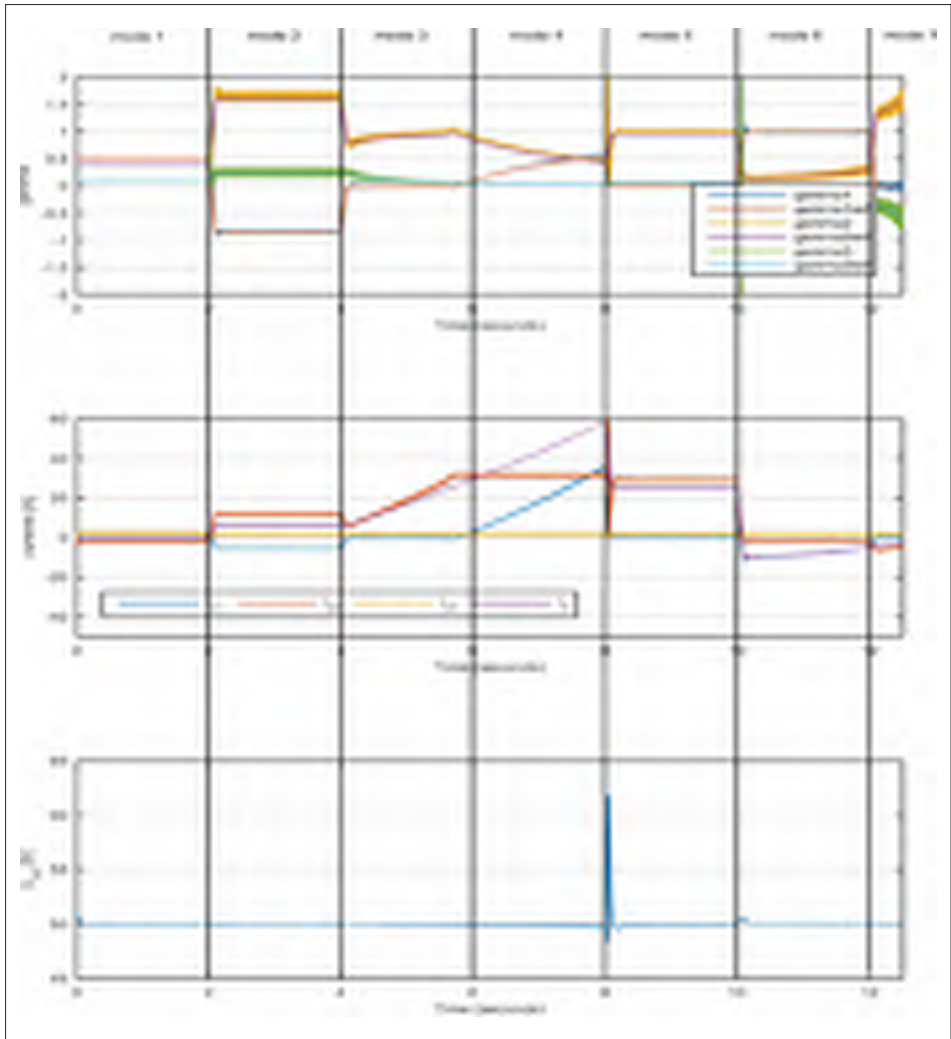


Figure 5 The plots of the gamma coefficients, device currents and DC link voltage during the drive cycle.

## 6 Conclusions

The proposed control system allows connecting any number of devices to HESS. The power of devices is easily controlled using gamma coefficients. An optimization of the energy management strategy is one of the most important issues in HESS. Well designed strategy can improve the overall system performance. The optimization process can be focused on system's efficiency, durability or power performance. It has also strong influence on sizing of the elements of the system. The proposed HESS uses renewable sun's energy in electric vehicle. The simulations show that the power of PV panel are fully used during the vehicle operation. Taking into account the growing number of electric cars it can come out as more beneficial solution than stationary solar charger, because the car is not forced to stop.

## References

- [1] Daoud, M.I., Abdel-Khalik, A.S., Elserougi, A., Ahmed, S., Massoud, A.M.: “DC bus control of an advanced flywheel energy storage kinetic traction system for electrified railway industry,” in IECON Proceedings (Industrial Electronics Conference), 2013, pp. 6596–6601.
- [2] Kim, Y., Koh, J., Xie, Q., Wang, Y., Chang, N., Pedram, M.: “A scalable and flexible hybrid energy storage system design and implementation,” *J. Power Sources*, vol. 255, pp. 410–422, 2014.
- [3] Fui Tie, S., Wei Tan, C.: “A review of energy sources and energy management system in electric vehicles,” *Renew. Sustain. Energy Rev.*, vol. 20, pp. 82–102, 2013.
- [4] Khaligh, A., Li, Z.: “Battery, Ultracapacitor, Fuel Cell, and Hybrid Energy Storage Systems for Electric, Hybrid Electric, Fuel Cell, and Plug-In Hybrid Electric Vehicles: State of the Art,” *IEEE Trans. Veh. Technol.*, vol. 59, no. 6, 2010.
- [5] Mouli, G.R.C, Bauer, P., Zeman, M.: “System design for a solar powered electric vehicle charging station for workplaces,” *Appl. Energy*, vol. 168, pp. 434–443, 2016.
- [6] Raman, S.R., Saritha, B., John, V.: “Computationally efficient and accurate modeling of Li-ion battery,” 2013 IEEE Innov. Smart Grid Technol. (ISGT Asia), pp. 1–6, 2013.
- [7] Salmi, T., Bouzguenda, M., Gastli, A., Masmoudi, A.: “MATLAB / Simulink Based Modelling of Solar Photovoltaic Cell,” *Int. J. Renew. ENERGY Res.*, vol. 2, no. 2, p. 6, 2012.
- [8] Thounthong, P., Raël, S., Davat, B.: “Energy management of fuel cell/battery/supercapacitor hybrid power source for vehicle applications,” *J. Power Sources*, vol. 193, pp. 376–385, 2009.
- [9] Allègre, A.L., Trigui, R., Bouscayrol, A.: “Different energy management strategies of Hybrid Energy Storage System (HESS) using batteries and supercapacitors for vehicular applications,” in 2010 IEEE Vehicle Power and Propulsion Conference, VPPC 2010, 2010.



## 5 URBAN TRANSPORT







## ROUTE GUIDANCE OF TRAM TRAFFIC IN CITIES: PARTICULARITIES OF TRAM TRAFFIC IN THE CITY OF OSIJEK

Martina Zagvozda, Sanja Dimter, Filip Ruška

*University of J.J. Strossmayer in Osijek, Faculty of Civil Engineering Osijek, Croatia*

### Abstract

An important part of the urban public transport system consists of a network of tramways which effectively connects parts of the city and / or suburban areas. Tram is suitable for the entire metropolitan area, in particular for wider central zone, and the transport capacity ranges from 4000 to 15,000 passengers per direction and per track per hour, depending on the method of running the tracks. Tracks can run as integrated or segregated on-street tramways or as off-street tramways wholly separated from pavement. The construction of the tram tracks on road surfaces is more expensive, traffic is slower, and special attention should be given to measures for traffic regulation due to frequent conflicts with other road users. Commonly, tracks are built separated for each direction of travel, but due to the lack of possibility for such traffic management, a single track can be performed for both directions of travel. The planning and construction of bi-directional single track is specific because of facilities like passing loops, signaling, etc., but also for presence and frequency of conflicts of tram with other types of traffic. The paper will describe solutions for tram traffic in the city of Osijek, with special emphasis on the tram traffic on by-directional single track tramway and increase of safety measures for conducting traffic.

*Keywords: tram infrastructure, by-directional single track tramway, conflicts, safety measures*

### 1 Introduction

Classic urban public transport system consists of two subsystems: road and rail, which differ from each other according to subsystem type, types of management and guidance of transportation device. An important part of the urban rail system is a network of tramways. The tram system consists of one or more electrical vehicles running on tracks along other modes of road traffic or as off-street tracks, while driver's only job is to control the riding speed of vehicle. This traffic mode allows minimum route width, higher travel quality and greater stability. Trams have good dynamic characteristics and provide a comfortable ride, but their reliability and speed depend on the conditions of the route. If the tram line passes through the narrow streets with heavy traffic, together with other traffic participants, speeds will be lower, and traffic delays greater. The best effect is achieved with off-street tracks completely separated from pavement. Thus, capacity of tram traffic driven on off-street tracks is 180 vehicles/h/direction, while capacity of trams driven in mixed traffic flow is 144 vehicles/h/direction [1].

#### 1.1 The position of the tram tracks in the cross-section of urban roads

Tram lines can be guided along pavement, as integrated or segregated on-street tramways, or as off-street tramways, embedded into concrete, ballast or grass turf. Typically tracks are built as two tramways, separated for each travel direction. However, in cross-section of urban roads

a single tramway line intended for two-way traffic can be built and in this case it is necessary to perform passing loops. Construction of the tram tracks on the pavements of urban streets is more expensive than the off-street routes, and special attention should be given to traffic regulation measures without which the tram movement becomes more difficult, and conflicts with other road users are very common. Conflicts of tram traffic with other types of traffic can be reduced by measures of traffic techniques, such as [1]:

- Prohibition of left turn at smaller intersections and their regulation with traffic lights at major intersections,
- Prohibition of traffic from minor streets to the unmarked intersections – allowed only right turns,
- The introduction of “signal island” at tramstop to prevent the entry of cars in the station zone,
- Activation of signals at intersections that allow the tram departure before other vehicles,
- Special signal phase for tram traffic diversion that allow the movement of trams without excessive delay,
- The prohibition of parking of vehicles,
- Labelling traffic lanes reserved for public transport – marking or installing specific elements on the roadway,
- Asymmetrical railway position and movement in opposite direction (especially useful for one-way streets).

These applications of traffic techniques have been introduced in many European cities in the mid-sixties and give very good results. With respect to the traffic safety, off-street guidance of tramlines is the best solution, it allows faster flow of vehicles and easier transit through intersections.

In this paper tramway system of the city of Osijek is described, as well as a specifics of route guidance solution in Divaltova street where tram traffic for both directions is driven on single tramway, while a part of the tramway route runs on pavement along road vehicles.

## 2 Tram system in the city of Osijek

### 2.1 Development of tramway system

Tram traffic in city of Osijek has been ongoing for many years. 132 years ago, precisely, on September 10th of 1884, a horse drawn tram started to operate (in that time called horse railroad). This was the first such form of urban transport in Croatia and south-eastern Europe. Launching the tram transport was extremely important step in connecting and modernizing the city and a key step in integration of still unconnected city parts, a role that has been kept throughout history [2].

Electrification of the city in 1926, created the preconditions for the start of operation of electric trams and it has been officially opened to traffic on December 17, 1926. The length of the tram tracks for electric trams in Osijek was around 10 km, including all branches and depot/ car house area [3].

Extension of the tram network of Osijek took place on several occasions: in the 60s (Retfala – Višnjevac), 2006. (Đakovština – Mačkamama), 2009. (Bosutsko – Divaltova – Jug II) and 2014. (Višnjevac) (Fig. 1).

Length of tram tracks today is approximately 29.2 kilometres (in city and outbound tracks in front of the depot). Tram line is fully operational and reliable for conducting tram traffic. It consists of 41 shunts and 5 crossovers. Tram line is for the most part embedded in concrete, approximately 25,3 km, while approximately 3,8 km is embedded in ballast [4].



Figure 1 Tram network in Osijek today [4]

## 2.2 Single tram line – particularities of tram traffic guidance in Divaltova street

In the city of Osijek in 2009 a single bi-directional tram line was built as part of construction and reconstruction of important city road in Divaltova street.

The tram track consists of: 6 passing loop, 13 shunts, 9 tram stops and 1 U-turn at Velebitska street (Fig. 2). The tram track is 4 413m long and split into 3 sections: section 1 – from Vinkovačka street to Kneza Trpimira street – 1 283m, section 2 – from Kneza Trpimira street to Srijemska street – 1 536m, section 3 – from Srijemska to Velebitska street – 1 594m [5]. Each section is shown on Fig. 2, differentiated by colour according to the type of route guidance. From route beginning in Vinkovačka street to Svilajska street tramway is segregated, running along left side of the road. In roundabout at intersection of Hutlerova and Divaltova street tram line crosses the pavement in an S shaped curve and than continues along the middle of the roadway until U-turn at the intersection of Divaltova with Velebitska St.



Figure 2 General layout with sections 1, 2, 3

Type of filling material dependeds on the location. From Vinkovačka street to Huttlerova street, where the track is in it own lane, the track is embedded into crushed stone ballast 30/50, while at level crossings and tramstops it is embedded into concrete and asphalt layer. Tramstop platforms are performed as elevated islands (+20 cm from rail) both along the edge of the pavement on sections 1 and 2 where the tracks are separated in the special lane (Fig. 3a), and also on section 3 where tram traffic takes place in middle of pavement (Fig. 3b).



Figure 3 Tram stops: a) along the edge of the pavement, b) in the middle of pavement

### 2.3 Conflict of road and rail traffic on the considered section

Along the route at Divaltova street tram line passes and crosses 14 intersections, 8 of which 8 are tree-legged, 5 four-legged and 1 is roundabout at Huttlerova street. Because of the specific mode of traffic these are potentially dangerous places for drivers, pedestrians and cyclists. Especially dangerous place are pedestrian crossings at the end of the promenade Sjenjak and in front of the school Fran Krsto Frankopan, regulated only by traffic sign.

#### 2.3.1 Accident record

Accident data [4] for the bi-directional single track in Divaltova Street in the 5 year period shows there has been a total of 80 accidents involving tram traffic. In figure 4. it can be seen there is a steady decline in number of accidents in the given period from 2011 to 2015. This means that drivers and other participants in traffic have gotten more aware of the risk for accident and thus more accustomed to this kind of traffic situation. Contribution to drivers awareness and decrease in occurrence of accidents can be also found in recently marked horizontal “tram” signs on pavement of some minor streets in proximity of intersection with Divaltova St. A closer look at distribution of accidents per location can give more insight into problematic situations and design.

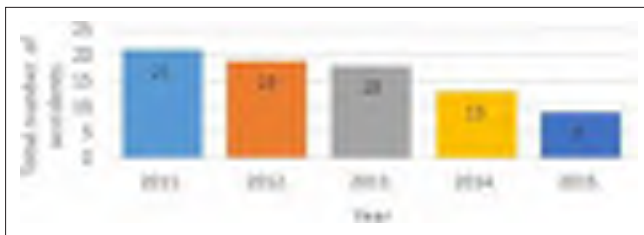


Figure 4 Total number of accidents per year [4]

#### 2.3.2 Route critical locations – increased number of accidents

Figure 5. shows locations with the highest number of accidents in 5 year period. A great number of this accidents occurred on smaller intersection without traffic lights, where only a few

of them have left turn lanes. Those are intersections of Divaltova Street with minor streets at Sjenjak area, Gacka, Reihl Kirova and Krbavska Street. It should be noted that Sjenjak includes several smaller streets connected to Divaltova Street, not an isolated intersection.

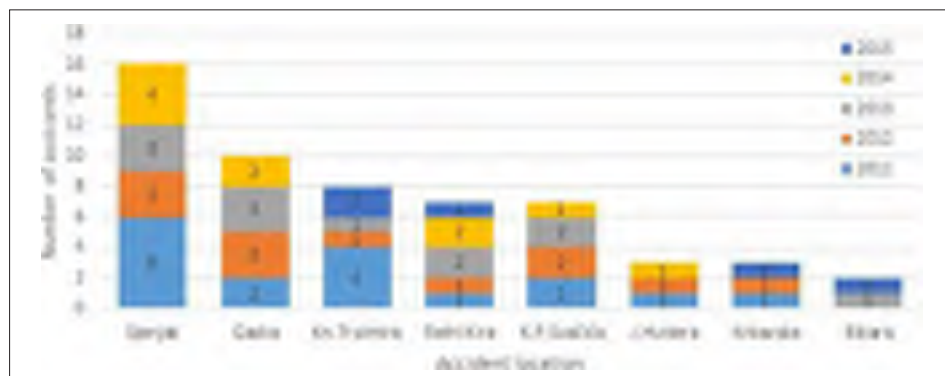


Figure 5 Distribution of accidents per location [4]

At intersections with Trpimirova St and Svačićeva St a high number of accidents was also recorded even though they are regulated by traffic lights. But this is intersection of streets with high average daily traffic, which is a possible cause of increased number of traffic accidents. Other instances of accident are isolated events distributed on the whole stretch of tram line.

### 2.3.3 Suggestions for possible improvements

Improvements of traffic safety, without major reconstructions, can be obtained through different measures of traffic techniques. Horizontal and vertical traffic signalization is an example of such measures that does not require large financial means and can be easily installed in short time period. Decision on solution type should be based on each location specificities, exiting signalization and occurring problems. On a given route two groups of solutions can be implemented depending whether it is a minor intersection or major one regulated by traffic lights. In major intersections that are already regulated with traffic lights a synchronization of left turning road traffic and passing trams should be done. The greatest safety issue here are permitted left turns governed by traffic lights coinciding with oncoming trams behind them. A simple signal phase that would allow tram departure before other vehicles could improve safety. At minor intersections there is a need for placing additional horizontal and vertical signalization that would emphasize the presence of the tram on the paths that would intersect with it. On the pavement of left turn lanes in Divaltova St. it is advisable to mark horizontal “tram” sign. Oncoming trams intersecting with the right turns in Divaltova St. could be emphasize with vertical signalization in form of blinking yellow lights. Vehicles approaching Divaltova St. from minor roads should have both horizontal and vertical signs warning them on intersecting with tramway. On certain locations yield signs should be replaces by stop signs due to questionable sight distance and reaction time of drivers.

## 3 Conclusion

Tram traffic in Osijek takes place on a network approximately 29,2 km long, of which 4,4 km is bi-directional single tramway in Divaltova St. Construction of single tramway in 2009 is significant for connection of southern city districts and also as modernization of transit in those neighbourhoods. However, in addition to the benefits of connecting parts of the city, specific two-way traffic results with higher number of traffic accidents than in the rest of the tram network where two-way traffic is separated on special tracks for each direction of travel.

The reasons are (other than the usual: negligence), primarily in the fact that motorists, cyclists and pedestrians do not expect the emergence of a tram in the west-east direction, a direction that is opposite to the movement of road vehicles on traffic lanes next to it. When the single track line opened to traffic, accidents were frequent, as confirmed by the official statistical data, but there was also a number of “conflict” that were avoided at the last minute and were not recorded. Road users that are daily driving, biking or walking along Divaltova St can testify to this. Certainly it is encouraging that over time the number of accidents decreased. It took time for all traffic participants to accept the bi-directional tram traffic on single tramway and adjust their behavior in traffic accordingly. Still, additional traffic technique measures can be made at different intersection as a measure of precaution to increase traffic safety. Installation of additional horizontal and vertical signalization, solutions that depend on location specificities, doesn't require large financial means or major reconstruction works but could have great benefits on traffic safety.

## Acknowledgement

The authors would like to thank Mr. Zoran Tanasić, CE, Head of the railroad and construction works, Gradski prijevoz putnika d.o.o. Osijek, who provided tramway network and accident data.

## References

- [1] Legac et al.: Gradske prometnice, University of Zagreb, Faculty of Transport and Traffic Sciences, 2011. (in Croatian)
- [2] <http://tehnicki-muzej.hr/hr/press/prvi-hrvatski-tramvaj---130.-obljetnica-osje%C4%8Dke-konjske-zeleznice,182.html>, 16.2.2016. (in Croatian)
- [3] <http://www.mso.hr/essekiana/index.php?trazi=elektrifikacija>, 19.02.2016 (in Croatian)
- [4] Overview of the Technical sector GPP, Gradski prijevoz putnika d.o.o. Osijek, May 2015. (in Croatian)
- [5] Šipoš, D., Vrselja, K., Škugor, D.: The technology of tram track building in Osijek, CETRA 2010-First International Conference on Road and Rail Infrastructure, Opatija, pp. 687-692, 2010.



## THE EVOLUTION OF URBAN TRANSPORT – UBER

Marko Slavulj<sup>1</sup>, Krešimir Kanižaj<sup>2</sup>, Siniša Đurđević<sup>3</sup>

<sup>1</sup> University of Zagreb, Faculty of Transport and Traffic Sciences, Croatia

<sup>2</sup> University of Zagreb, Faculty of Transport and Traffic Sciences, Croatia

<sup>3</sup> Bolnička cesta 34a, 10090 Zagreb, Croatia

### Abstract

Uber is an application that connects passengers with drivers who have a contract with Uber. To order a vehicle it is necessary to own a smartphone and to register within the mobile application by entering your name, e-mail address, a cell phone number and a credit card number that is to be billed automatically at the end of the ride. Global positioning system in the smartphone is used to determine the location so the passenger does not have to know the exact pickup address. The ride order appears on the nearest driver's smartphone application and he/she can accept or reject the ride. Uber is controversial because of its UberPop service that connects passengers with unlicensed drivers, people that own a four-door car and a smartphone, and have passed a background and employment history check. Due to this service, some countries have changed laws regarding transport services. Uber's position in these cases is constant because they are officially not a transport company, but they are a technology company. In 2014 Uber introduced its UberPool service in San Francisco that allows sharing a ride with a stranger who intends to ride along the same route. The savings when joining that type of service can reach up to 40%. Uber started in Zagreb on 21 October 2015, offering fares about 15% lower than the conventional taxi service who greeted their arrival negatively. Taxi service in Zagreb was regulated until 2010 when a partial deregulation was conducted, allowing new companies to enter the market, the biggest and most successful being Taxi Cammeo and Eko Taxi. The purpose and goal of this paper will be research of demand for Uber service in Zagreb, to make a price comparison with major taxi companies and to explore the possibilities for improving the legislation regarding the area of taxi service.

*Keywords: taxi, uber, transport service, smartphone application, Zagreb*

### 1 Introduction

Travis Kalanick, one of Uber's founders says: "There was an Uber way before Uber. And if it has survived, the future of transportation would probably already be here". It was called Jitney Bus [1], and the idea behind it was that every driver can put a sign on his or her car to drive anyone anywhere they want to go for a jitney (which was a slang for a nickel, a five-cent piece). Within the first year, in 1915 the Jitney bus had a 150K rides per day in Los Angeles and much more in total across the country; in comparison, Uber is doing 157K rides per day today. The "trolley guys", as he calls them, were not happy about this and got to cities across the country, had regulations put in place to slow down the growth of the Jitney. What happened was that by 1919 Jitney was regulated out of existence.

Now, almost 100 years later, Uber operates successfully in Zagreb, saying they have 50K people opening the Uber app in the first two weeks after launch, and 13K even before Uber was launched. Furthermore, [2] 8K users was registered in first two weeks and the average driver score was 4.8 (out of 5) which makes Uber Zagreb drivers one of the best in the area.



The idea behind this paper was to see what Uber is, how it was launched in Croatia, what stood (and still stands) on its way in terms of legislation, to compare it with the conventional taxi service in Zagreb and to answer the question why Zagreb (and any other city) needs Uber and what are the advantages that Uber bring to the community.

## 2 About Uber

### 2.1 History

Uber Technologies Inc. is an American company that develops and offers the Uber mobile application, the application that connects potential passengers with drivers who use their own vehicles. The company was founded in San Francisco in 2009 and started marketing the free mobile application in 2011. That same year Uber expanded to New York City, Chicago and Washington, D.C. and later that year in Paris, France. Since then they continued their expansion to Toronto, London, Sydney, Singapore, Johannesburg and other markets such as Seoul, Tijuana, Peking and Delhi. 2014 saw them entering smaller markets such as Warsaw, Anchorage, Copenhagen and Lagos. As of April 2016, Uber services are available in 405 cities in 60 countries on all 7 continents. In October 2015 Uber came to Zagreb, the capital and the biggest city of Croatia (Figure 1).



Figure 1 Uber application openings since launch (left) and trip route coverage (right) [2]

### 2.2 Uber services

Uber was started with an idea of a luxury transport which can be hailed via mobile phone, but has developed into something much more over the years. New services were offered and they can be chosen in the application while detailing a pick-up location. Those services are:

- UberT – Potential passengers can hail the official taxi service in that particular town. In New York City, for example, those are “yellow” taxi cabs with a medallion and Boro taxi cabs. Uber charges the application usage and the passenger pays the driver himself.
- UberX – The most famous Uber service. Usually cheaper than the official taxi cabs for 15-20%.
- UberPop – A service that connects potential passengers with unlicensed drivers that have a contract with Uber and have passed their background check. This service is the cause of great controversy which escalated into riots in the city of Paris.
- UberPOOL – Launched in 2014, this is Uber’s most affordable service. It allows ride sharing with strangers who intend to go the same route. Fare savings can reach up to 40% and if the application cannot find another passenger the sole passenger gets a 10% discount.
- UberMOTO – A low-cost motorcycle transport service launched in February 2016 in Bangkok. Passengers can pay the cab fare in cash or with a credit card.
- UberBlack – The original Uber service which includes luxury vehicles.

- UberSUV – Passenger transport with spacy vehicles.
- UberXL – Passenger transport for large groups.

### 2.3 How Uber works

To order a ride it is necessary to own a smartphone and to register within the mobile application by entering a name, an e-mail address, a cell phone number and a credit card number that is to be billed automatically at the end of the ride. Global positioning system in the smartphone is used to determine the location so the passenger does not have to know the exact pickup address. Booking a ride in advance is not possible. Before confirming the order, the passenger can enter a pick-up and a drop-off address and get a price estimate. Once completed, the ride order appears on the nearest driver's smartphone where he or she can accept or reject it. It is possible to keep track of the vehicle that has accepted the ride. Driver's and passenger's contact information is also shown so they can contact each other if needed. The ride can be cancelled free of charge within five minutes, after that a fixed fee is charged to the passenger's account. An automated message is sent by the application upon the car's arrival. The driver starts the ride on the application and the passenger is shown the route and the estimated time of arrival. After the ride, the credit card specified in the app is automatically charged and the bill is sent via e-mail. The application allows bill sharing with other passengers. The driver and passenger can rate each other in application with a score from one to five stars. Uber charges a base fare, the distance and the time spent driving regardless of whether the vehicle is moving or not. Prices vary from city to city but each one has a fixed minimum fare to be paid if the fare is lower. Uber uses an algorithm that increases the cost in time of increased demand, such as rush hour or a city-wide emergency. It is called "surge pricing", a method of pricing in the free market that involves the raising or lowering of prices depending on supply (how many cars are available) and demand (how many passengers want to ride in them). Sometimes prices for Uber services, depending on the intensity of demand, are increased by a certain percentage, and at other times they could even be doubled or tripled, and these fare hikes take effect during periods of high demand for cars (e.g. rush hours, dates of concert events, and during rain and snow storms or public transport strikes). Depending on supply and demand, the fare may be increased tenfold. However, the potential passenger is always shown this information before confirming the ride.

## 3 Legislation

When Uber announced its presence in Zagreb, they faced many obstacles related to legislation, mainly due to a lack of understanding what Uber really is. Uber is perceived as a taxi company by the authorities and the conventional taxi companies thus expected to follow the rules that all other taxi companies in Zagreb have to follow.

### 3.1 The reasons for banning Uber around the world

What most people will first remember when someone says "Uber" are riots in Paris in January 2016, then Uber being banned in Brussels in September 2015 and articles like "Uber ordered to shut Brussels service within 21 days ..." etc. What they do not know is that in fact the problem was the UberPop service where the drivers were independent individuals that undergo only Uber's internal check and they have to have a valid driver's license for at least 3 years. And there is the problem – an "ordinary" driver can become a competitor with the taxi drivers who have to undergo a much thorough check and have to obey all applicable laws and regulations. Yes, UberX is, more or less, "common ground" but, in case of Zagreb, drivers that use Uber can and should be able to continue working if they have a company that offers the services of renting a vehicle with a driver.

What should be emphasized, and it was not in Zagreb's case, is the way Uber operates – along with taking share of the markets and earning profit like any other company they try to improve the market by encouraging people to share rides and reduce the use of their own vehicles, increasing the mobility and lowering the pollution and the use of public space for parking. One of the positive examples is Estonia – one of EU's most advanced countries speaking in terms of using ICT – where the Tax and Customs Board and Uber created a working group to examine what are the appropriate solutions for payment of taxes for the expanding sharing economy services across Europe (like Uber, Airbnb and Coursera). The goal of the pilot project is to produce a new tax declaration platform and simplify the process of tax declaring for Uber's partner drivers. The first results are expected in 2016 and Marek Helm, the Director General of tax and Customs Board, says [3]: “Earning a revenue and payment of taxes on it should not be a burden. It is the tax authority's work here to think about how in the co-operation with businesses to create smooth and transparent technical solutions that give businesses the assurance that things are in order.” Looking from one point of view this is a great marketing from (and for) Uber, but looking from another – this shows how Uber wants to do business.

### **3.2 Why drivers that use Uber and Uber itself do not have to meet the legal requirements and other taxi drivers in Zagreb have to?**

The answer is fairly simple – Uber Croatia LLC is not a taxi company and drivers that use Uber app are not taxi drivers. Uber is a company registered to represent and promote the company Uber and to do market research [4]. Uber drivers are not taxi drivers, they own a company or work for one that is registered for chauffeur service. If they are employed or own a taxi company they have to remove the TAXI signs when taking a passenger with Uber, they must not use a yellow lane like taxi drivers can etc.

After an article that, after only three sentences, concludes “Uber is legal in Croatia” [5], an e-mail was sent to the Ministry of Maritime Affairs, Transport and Infrastructure. On 4 March 2016 an answer was received “confirming the article as Uber Croatia LLC in fact does marketing and product promotion for the Uber application owned by a Dutch company UBER B.V. and that Uber Croatia LLC does not manage the Uber application for the area of Zagreb. In the following period the Ministry will control the compliance with the Croatian Road Transport Law and other legislation on taxi transport in Zagreb for the drivers/companies that use the Uber application. Furthermore, they forwarded the case to the Tax Administration, Customs Administration and the Croatian Competition Agency to further process this issue.”

On 21 March 2016 an answer was received from the Tax Administration stating that the Croatian Tax Law does not allow them to disclose the information on tax proceedings, and the Customs Administration confirmed that they never conducted an inspection control of the company Uber Croatia LLC. An answer from the Croatian Competition Agency states that they did not initiate any proceedings in this matter as it is not in their jurisdiction.

The Court Register in Zagreb stated on 6 April 2016 that they are aware of the “Uber issue” and that it is not possible to register a company with the chauffeur service and they suggest their clients that want to work with Uber to register the company for renting motor vehicles given that this is “a broader term than chauffeur service”.

This article describes the challenges Uber is facing and will have to face in the future – shortcomings in the legal system (it is not possible to register a chauffeur service), disinformation in the news, and linking the UberX service with taxi. In the above mentioned answer from the Ministry they stated “they will control the compliance with the Croatian Road Transport Law and other legislation on taxi transport in Zagreb for the drivers/companies that use the Uber application” which simply does not make sense – they are not taxi drivers. The best example for disinformation are articles where the question “Who is can be an Uber driver?” is answered with “Uber drivers do not have a taxi licence and a taximeter, almost anyone with a valid driver

licence and a vehicle can apply to be an Uber driver” [6]. The only thing the disinformation brings is more dissatisfaction and anger for those who would like order in this area of transportation, and many of them currently working in Zagreb taxi service.

### 3.3 How and why did the Customs check “Uber drivers”?

On 12 December 2015 an “incredible action against Uber drivers” was conducted [7], stopping more than 50 drivers in different locations around Zagreb. Four of them were found in violation of the Croatian Transport Law and the Regulation on Taxi Transport in Zagreb thus violating the law prohibiting and preventing the carrying out unregistered activities, punishable by Article 10 of that same law – their vehicles were impounded and they were fined. The same thing happened as in the case of the Ministry's response above – the drivers that use Uber were treated as taxi drivers which they simply are – not. The process not being finished neither side wanted to comment its outcome, and Uber officials during the Startup Wednesday [8] said that “they rented the vehicles for those four drivers to be able to work the day after and paid for the fines”.

## 4 Price comparison between taxi services in Zagreb and Uber

For the comparison shown in the Figure 2 below the route from the city centre to the Zagreb Airport was used, a distance of 16.4 kilometres in two different periods of the day – 8 a.m. (rush hour) when it takes about 40 minutes to make that trip and 8 p.m. when it takes less than 30 minutes. The variables for the calculation were: the price of a call (if the taxi service does not have a mobile application), the start price, the price per kilometre and the price per minute.



Figure 2 Price comparison

The practice in most cities where they have UberX shows that UberX is cheaper than the taxi service. In the future Uber plans to introduce the UberPOOL service to lower the trip costs even more. At the moment you can only share a ride with a person that is standing next to you – you input his or her e-mail address in the application and the price will be split.

## 5 Conclusion

Zagreb needs Uber mainly because the taxi services in Zagreb missed the opportunity to improve [9] in a way that will make Uber just “another player in the field”. They could have lowered the prices improving their operations so that more people can use the taxi service on a daily basis, they could have tried to change the regulations so rides can be shared, and they could have established a much higher quality control of their drivers' services – they had more than five years to do that.

If the fare price was taken out of the equation, Uber's biggest competitive advantages are convenience and transparency of services. No cash changes hands (thus the opportunity to hide the profit is none) and there is no need to have your credit card on you. When you arrive at your destination you can simply walk out of the car, your account will be automatically charged and an e-mail receipt will be sent to you – and life is much easier because there is no need to have any change or to collect and track paper receipts. Both unprofessional drivers and rude passengers are weeded out because they get to rate one another after the ride and see the rating before they accept the ride – and a consistently low rating will force both of them out of Uber.

One of Uber's goals is “get more people into fewer cars” [10] – a goal everyone with common sense should have – less cars, less parking spaces in the city area and that combined with stimulations for the use of hybrid cars can get us to a better, cleaner and less noisy society. The negative aspect of Uber is surge pricing, as seen in London during the tube strike [11]. However, if there is no cheap (yet high-quality) alternative to public transport the passengers are stuck either walking or taking a far more expensive taxi service. Another negative aspect is one that has not struck Zagreb yet – a battle to provide the cheapest service between Uber-like applications. Unfortunately, this battle is being fought on the backs of drivers, who bear most of the expenses and this can only add extra stress for the drivers and, if not corrected, will bring about poor service in the long term.

Uber will most definitely stir things up in Zagreb even more when they introduce the UberPOOL service. As seen from this paper drivers that use Uber are (still) considered taxi drivers even by the authorities and Croatian Law considers taxi ride to be “a ride where passengers are picked up based on one order and charged with only one receipt”.

## References

- [1] Štefančić, G.: Tehnologija gradskog prometa I, Fakultet prometnih znanosti, Zagreb, 2008. (p. 221)
- [2] UBER Newsroom, <https://newsroom.uber.com/croatia/uber-zagreb-results-after-the-first-two-weeks-hvalazagreb/>, 11 November 2015
- [3] The BALTIC COURSE, <http://tinyurl.com/The-BALTIC-COURSE>, 7 October 2015
- [4] Croatian Court Register, <http://tinyurl.com/Uber-Court-Register>, 1 April 2015
- [5] Poslovni Puls, <http://tinyurl.com/Ministry-on-Uber>, 11 November 2015
- [6] TELEGRAM.hr, <http://tinyurl.com/Telegram-Uber-announced>, 19 April 2015
- [7] Index.hr, <http://tinyurl.com/Uber-setup>, 14 December 2015
- [8] “Startup Wednesday”, <http://tinyurl.com/CRANE-Startup-Wednesday-meetup>, 30 March 2016
- [9] Brčić, D., Šimunović, Lj., Slavulj, M.: Upravljanje prijevoznom potražnjom u gradovima, Priručnik, Fakultet prometnih znanosti, Zagreb, 2016. (p. 53)
- [10] TED, Travis Kalanick: “Uber's plan to get more people into fewer cars”, <http://tinyurl.com/more-people-into-fewer-cars>, 25 March 2016
- [11] UBER Newsroom, <https://newsroom.uber.com/uk/tube-strike/>, 9 July 2015



## STUDY ON USAGE BEHAVIOUR OF THE ARTERIAL TRAFFIC IN JAPAN

**Kosuke Koike, Makoto Fujiu, Shoichiro Nakayama, Jun-ichi Takayama**  
*Kanazawa University, Department of Civil Engineering, Japan*

### Abstract

The arterial traffic network in Japan has been almost established because main points are connected by rail, air routes and expressway. The travel time is significantly reduced as compared to before due to speed up the arterial traffic in recent years. As a typical example of the arterial transportation include the Shinkansen, air plane and long-distance expressway bus. The Shinkansen and air plane is in the very competitive state in Japan. Because different preeminent transportation in the region in areas where both can be selected. On the other hand, long-distance expressway bus develops with the expansion of the expressway network. It has become a popular transportation around the student due to low fare compared with the Shinkansen and air plane. In this way the arterial traffic has changed with the development of the arterial traffic network. In addition, it is utilized by the personal attributes have influence on the easy to select transportation. The purpose of this study is to analyze how usage behavior changes by the development of the arterial traffic network, and creation of a transportation choice model considering the personal attributes. Behavior in Japan are analyzed using Inter-Regional Travel Survey in Japan and Air Passengers Observational Survey by Ministry of Land, Infrastructure, transport and tourism Government of Japan. As a result of this study, it become clear that person has a high annual income easy to select air plane, user has remained from sleeping limited express to the long-distance expressway bus, the boundary to select the Shinkansen or air plane.

*Keywords: arterial traffic, behaviour, Shinkansen, expressway, Inter-Region Travel*

### 1 Introduction

Arterial traffic network connecting between cities has continued to expand. This has led to major changes in human behaviour. In Japan, the Shinkansen network has been conducted since 1964 the Tokaido Shinkansen was opened. Today, the Shinkansen network has continued the expansion. In 2011, Kyusyu Shinkansen whole line, in 2015, Hokuriku Shinkansen between Nagano Kanazawa, in 2016, Hokkaido Shinkansen between Shinaomori Shinhakodate-Hokuto has opened. In addition, the highway is opened to traffic in the last year of Tokaido Shinkansen opening. It was only 71.7 km long at first, but current total extension of highway in Japan is 10685 km long. Ultimately aims to total length of 14000 km, the construction work is still progress.

In Japan, main points are linked by arterial traffic such as the Shinkansen, highway and air lines. Therefore this network would said to almost completed. These arterial traffic are in the very competitive state due to expansion of network. For example, the Shinkansen to airline and the Shinkansen to long-distance expressway bus (highway bus) are very good examples. In order to win such competitive state, each transportation working to improve level of service (LOS). Such as speed up, price cuts, and so on. Improvement of LOS is carried out for expan-

sion of passengers. But this case is concern that excessive service provision is offered. It is essential in order to provide the appropriate services to understand the user characteristics of each transport.

The purpose of this study is to analyze how usage behavior changes by the development of the arterial traffic network. In this study to target the arterial traffic network such as the Shinkansen, highway bus, and airline. Behavior in Japan are analyzed using three time points Inter-Regional Travel Survey in Japan by Ministry of Land, Infrastructure, transport and tourism Government of Japan. By using this data, it will be cleared about user characteristics and the influence and a change in the travel behavior when a new arterial traffic was opened to the existing OD pair.

## 2 Methods of analysis

### 2.1 Inter-Regional Travel Survey in Japan

Inter-Regional Travel Survey is carried out the arterial traffic user as a target by Ministry of Land, Infrastructure, transport and tourism Government of Japan. This is a national scale survey to investigate the trip from origin to destination beyond the prefecture by using arterial traffic. From the survey results, it is possible to grasp the reality of the trip such as, who, where to where, when, what purpose, what transportation, and so on. Table 1 shows corresponding investigation and arterial transportation. These survey results are integrated into one and to set magnification factor by a statistical method. In this study using three time point (2000, 2005, 2010) survey data. The number of trips of each transportation of each survey as shown in table 2.

Table 1 Corresponding survey and transportation (in Japanese)

transportation	survey(japanese)
airline	航空旅客動態調査
railway	幹線鉄道旅客流動実態調査
car	全国道路・街路交通情勢調査
ship	幹線フェリー・幹線旅客船旅客流動調査
highwaybus	幹線バス旅客流動調査

Table 2 Number of trip data

year	number of data		
	2000	2005	2010
air	152337	107586	96067
bus	34810	49247	28625
car	194446	228223	513122
rail	62415	72397	57967
ship	5499	4680	2807

### 2.2 Overview of analysis

Figure 1 shows a map of Japan segmented in 207 zone. In this study using a magnification factor set to this zoning based. To extract the required data by the screening. Then, remove the dummy data inserted for setting magnification factor and partitioning the trip by the representative transportation.

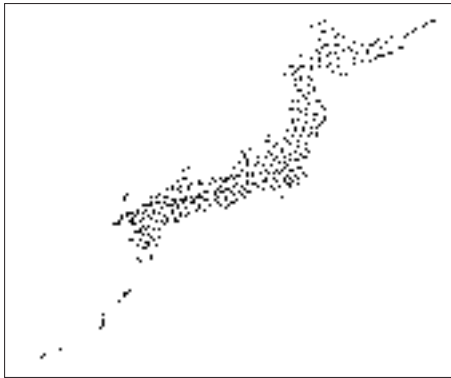


Figure 1 Japan segmented 207 zone

### 3 Basic analysis

#### 3.1 Number of trips and Modal share

The number of trips shown in table 3 and 207 zone based modal share shown in table 4. The number of total trips has been decrease with each inning. Modal share has not a large difference. It can be seen that car is selected easily and demand of travel by car is increasing year by year. The railway share is high in the Tokyo metropolitan area and Keihanshin area. Car share had become higher in the surrounding area of major metropolitan area.

Table 3 Number of trips

year	trip					total
	air	bus	car	rail	ship	
2000	250411.1	75916.9	2467906.9	396307.0	23909.2	3609521.1
2005	169630.0	116872.8	2468794.5	359531.3	18417.6	3632146.1
2010	158469.7	66378.2	2626470.9	612822.2	9129.6	3113860.1

Table 4 Modal share (207 zone based)

year	share%				
	air	bus	car	rail	ship
2000	5.9	2.0	50.3	22.1	0.7
2005	4.8	3.0	58.9	21.8	0.5
2010	4.1	2.0	74.9	18.2	0.3

#### 3.2 Attributes of the user

It is included personal attributes such as gender, travel purpose, age in survey data. In 2000 and 2005 survey are also included annual income of data. Table 5 through Table 8 shows that result of basic counting about personal attributes. Relationship between gender and transportation is that the proportion of men of air, car, rail is high. This is due to business trips. From the Table 6, bus is popular in young people and air is easy to use a layer of from



40s to 50s. Because bus is low price, it is popular with young people such as students. From the Table 7, air user it can be seen that the proportion of high-income earners is high. The average annual income of bus users is about 1.5 million yen, the user of the low income was shown to be dominant. The average of annual income of Japanese is 4.14 million yen. Car is likely to be selected for all purposes be seen from the Table 8.

Table 5 Relationship between gender and transportation

year	mode	2000		2005		2010	
		male	female	male	female	male	female
2000	air	28.5%	21.5%	32.1%	26.7%	37.8%	32.2%
	car	54.0%	45.0%	51.5%	40.0%	41.7%	52.3%
	taxi	17.0%	27.7%	19.7%	23.8%	20.9%	23.1%
	rail	10.4%	26.6%	12.3%	22.1%	21.6%	22.1%
	bus	29.5%	31.7%	29.9%	30.3%	29.0%	33.0%

Table 6 Relationship between age and transportation

year	mode	2000					2005					2010					
		10	20	30	40	50+	10	20	30	40	50+	10	20	30	40	50+	
2000	air	5%	2%	1%	1%	1%	6%	3%	2%	1%	1%	6%	3%	2%	1%	1%	1%
	car	12%	21%	12%	14%	19%	17%	22%	19%	19%	21%	16%	20%	19%	17%	14%	12%
	taxi	10%	15%	19%	22%	13%	21%	18%	15%	21%	21%	16%	19%	19%	21%	21%	15%
	rail	30%	15%	22%	21%	11%	25%	18%	16%	16%	23%	24%	19%	22%	23%	23%	17%
	bus	54%	21%	22%	24%	22%	22%	21%	21%	23%	25%	22%	21%	25%	21%	21%	23%
	other	13%	20%	22%	19%	20%	15%	25%	26%	18%	16%	19%	21%	17%	21%	24%	24%

Table 7 Relationship between annual income and transportation

year	annual income (100,000)	2000				2005			
		air	bus	rail	ship	air	bus	rail	ship
2000	None/68	14.1%	17.2%	9.4%	21.5%	17.0%	19.1%	11.2%	12.1%
	~100	2.8%	0.2%	3.7%	3.2%	4.3%	10.5%	4.8%	3.5%
	100~199	9.8%	19.7%	9.7%	10.2%	10.7%	21.1%	19.9%	21.0%
	200~299	15.8%	17.9%	17.0%	22.0%	15.0%	18.5%	16.5%	22.4%
	300~399	14.0%	11.5%	17.9%	10.9%	13.9%	12.0%	17.7%	12.6%
	400~499	16.0%	14.7%	20.8%	10.1%	18.5%	11.5%	20.5%	9.4%
	500~599	16.0%	7.4%	14.3%	5.0%	13.1%	6.1%	12.5%	4.6%
	700~899	4.0%	1.3%	3.4%	0.8%	2.7%	0.8%	2.7%	0.9%
	9000~1499	1.0%	1.1%	5.5%	2.0%	1.2%	0.7%	2.5%	1.0%

Table 8 Relationship between travel purpose and transportation

year	purpose	2000				2005				2010				
		air	bus	rail	ship	air	bus	rail	ship	air	bus	rail	ship	
2000	business	54%	42%	25%	68%	27%	50%	40%	84%	65%	32%	25%	20%	62%
	tourism	37%	15%	14%	12%	21%	23%	15%	50%	15%	27%	25%	25%	50%
	private	9%	30%	11%	14%	16%	12%	23%	15%	27%	14%	23%	15%	26%
	other	7%	13%	24%	5%	22%	31%	11%	24%	8%	12%	23%	7%	12%

#### 4 Changes of arterial traffic network

Figure 2 shows the changes of the Shinkansen, highway and number of airports user. And Table 9 shows chronology of arterial traffic network.

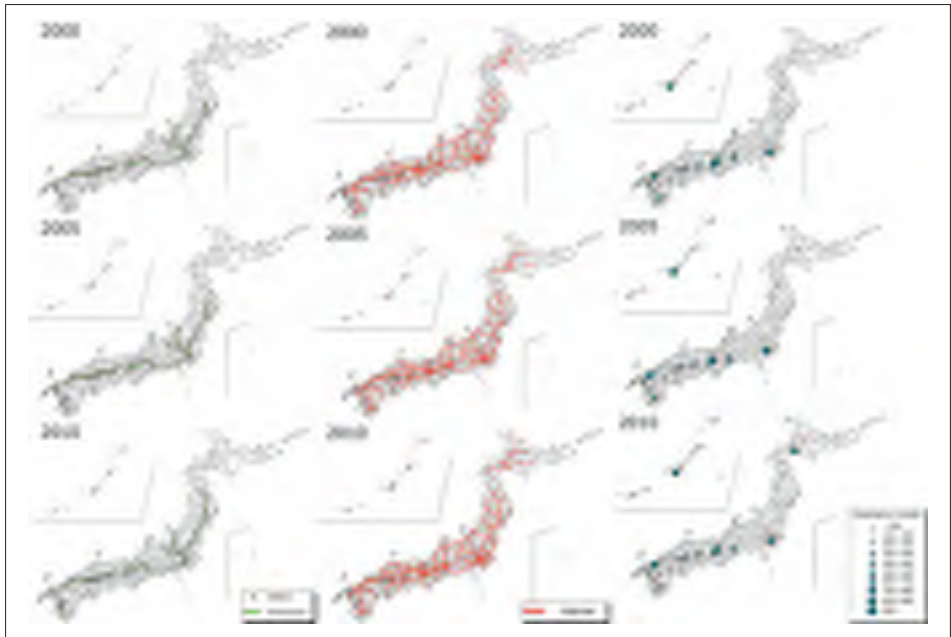


Figure 2 Changes of arterial traffic network (2000-2010)

Table 9 Chronology of arterial traffic network

Year	Arterial Network	Highway	Station
1960s	Tokaido Shinkansen (Tokyo-Nagoya)	Metropolitan Expressway Keihin Expressway Toei Expressway	57 airports opened
1970s	Sanyo Shinkansen (Osaka-Kobe)	Sanyo Expressway to 200km	16 airports opened
1980s	Tokaido Shinkansen (Miyagi-Sendai) Toei Expressway (Miyagi-Tokyo)	Chuo Expressway Sanyo Expressway to 400km	17 airports opened
1990s	Tokaido Shinkansen (Yokohama-Utsunomiya) Hokuriku Shinkansen (Nagano-Tokyo)	Fukuoka-Kyushu Expressway Kanto Expressway Sanyo Expressway to 600km	Kanbara Airport opened 18 airports opened New Tokyo Skytree (24 m) completed (Hokuriku Express)
2000s	Tokaido Shinkansen (Miyazaki-Nagasaki) Kyushu Shinkansen (Nagasaki-Kagoshima) Toei Expressway (Tokyo-Saitama)	Osaka-Kansai Expressway Tokaido Shinkansen Expressway	Osaka Airport opened 12 airports opened
2010s	S20 Inter-urban (Miyazaki) Toei Shinkansen (Niigata-Fukushima) Miyazaki Shinkansen (Niigata-Fukushima) Miyazaki Shinkansen (Niigata-Fukushima) Miyazaki Shinkansen (Niigata-Fukushima)	Shiga-Tokyo Expressway Itoya Expressway	3 airports opened

## 5 User characteristics

In this chapter, a more detailed analysis by cross tabulation of travel purpose and personal attributes. Table 10 shows the results of cross tabulation of purpose and gender. The majority of the business trip is a male. On the other hand, the majority of tourism trip using air, bus and railway is a female. Car user is almost male. From Table 11, it can be seen that the bus is mainly used by young people at homecoming and private. In addition, percentage of low income is higher.

Table 10 Cross tabulation of purpose and gender

mode	purpose	2000		2015		2030	
		male	female	male	female	male	female
all	business	90.7%	93%	87.7%	72.3%	87.3%	72.7%
	tourism	43.4%	56.6%	48.6%	58.6%	42.1%	57.9%
	private	40.6%	50.4%	39.4%	60.6%	39.2%	60.8%
	others	47.0%	53.0%	48.2%	51.8%	40.0%	57.0%
bus	business	84.2%	15.0%	78.6%	21.4%	76.0%	22.0%
	tourism	33.1%	66.9%	25.0%	64.4%	34.7%	65.2%
	private	39.0%	70.0%	25.5%	70.5%	39.5%	69.5%
	others	36.1%	63.9%	34.9%	65.1%	33.3%	66.6%
rail	business	84.0%	5.0%	93.5%	6.4%	94.3%	5.0%
	tourism	75.0%	24.2%	79.5%	20.5%	91.4%	19.6%
	private	59.2%	40.7%	62.1%	37.9%	57.8%	42.2%
	others	75.2%	24.8%	73.2%	26.8%	71.2%	28.8%
car	business	89.5%	70.5%	80.3%	73.7%	86.7%	72.2%
	tourism	39.0%	51.0%	34.6%	65.4%	38.6%	61.5%
	private	34.7%	55.3%	28.1%	70.0%	40.3%	59.7%
	others	45.4%	55.6%	36.0%	64.0%	46.2%	55.8%

Table 11 Cross tabulation of purpose and age

mode	purpose	2000				2015				2030			
		15-19	20-24	25-29	30-34	15-19	20-24	25-29	30-34	15-19	20-24	25-29	30-34
all	business	65	44	20	10	28	17	8	3	10	6	3	1
	tourism	17	16	34	23	22	26	19	12	14	14	10	14
	private	14	10	14	16	23	17	12	14	17	12	11	14
	others	24	21	12	12	16	15	10	12	12	11	8	10
bus	business	10	4	1	0	4	1	0	0	1	0	0	0
	tourism	1	1	1	1	1	1	1	1	1	1	1	1
	private	1	1	1	1	1	1	1	1	1	1	1	1
	others	1	1	1	1	1	1	1	1	1	1	1	1
rail	business	1	1	1	1	1	1	1	1	1	1	1	1
	tourism	1	1	1	1	1	1	1	1	1	1	1	1
	private	1	1	1	1	1	1	1	1	1	1	1	1
	others	1	1	1	1	1	1	1	1	1	1	1	1
car	business	1	1	1	1	1	1	1	1	1	1	1	1
	tourism	1	1	1	1	1	1	1	1	1	1	1	1
	private	1	1	1	1	1	1	1	1	1	1	1	1
	others	1	1	1	1	1	1	1	1	1	1	1	1

Table 12 Cross tabulation of purpose and annual income

mode	purpose	2000				2015				2030			
		10000	20000	30000	40000	10000	20000	30000	40000	10000	20000	30000	40000
all	business	1	1	1	1	1	1	1	1	1	1	1	1
	tourism	1	1	1	1	1	1	1	1	1	1	1	1
	private	1	1	1	1	1	1	1	1	1	1	1	1
	others	1	1	1	1	1	1	1	1	1	1	1	1
bus	business	1	1	1	1	1	1	1	1	1	1	1	1
	tourism	1	1	1	1	1	1	1	1	1	1	1	1
	private	1	1	1	1	1	1	1	1	1	1	1	1
	others	1	1	1	1	1	1	1	1	1	1	1	1
rail	business	1	1	1	1	1	1	1	1	1	1	1	1
	tourism	1	1	1	1	1	1	1	1	1	1	1	1
	private	1	1	1	1	1	1	1	1	1	1	1	1
	others	1	1	1	1	1	1	1	1	1	1	1	1
car	business	1	1	1	1	1	1	1	1	1	1	1	1
	tourism	1	1	1	1	1	1	1	1	1	1	1	1
	private	1	1	1	1	1	1	1	1	1	1	1	1
	others	1	1	1	1	1	1	1	1	1	1	1	1

## 6 Changes in modal share

Figure 3 shows the difference between modal shares of tourism of each survey. From Figure 3, it can be said the air and rail share has risen. The spread of mobile terminal is estimated to be a factor. It would be make easy to take a reservation for transportation. In addition, railway share is increased in trackside area when the shinkansen stretch opening. A similar trend is also seen in air share. The opening of Central Japan International Airport increased air share in Aichi prefecture. In this way, the development of arterial traffic network change the transportation mode of residents in the vicinity of that.

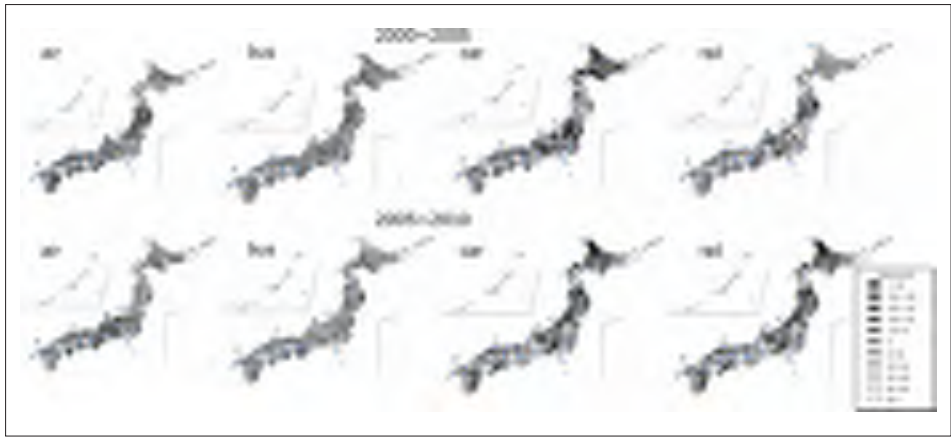


Figure 3 The difference between the share of 2000 to 2005, 2005 to 2010

## 7 Conclusions

It is suggested that the choice of transportation is different depending on annual income. For example, relatively air user has a high income but bus user has low income. It is estimated that has become popular around the student due to expanding the number of bus routes. From the analysis of difference of modal share, the conversion has been confirmed of the existing transportation by the development of new transportation. In the future, the construction of transportation choice model considering user characteristics and OD pair.

## References

- [1] Shimohara, S., Kaneko, Y., Shimazaki, T.: Analysis of Short-Distance Expressway Bus Travel Behaviour Using Inter-region Travel Survey Data, Proceedings of JSCE, 2008, [http://library.jsce.or.jp/jsce/open/00039/200806\\_no37/pdf/59.pdf](http://library.jsce.or.jp/jsce/open/00039/200806_no37/pdf/59.pdf)
- [2] Hazemoto, J., Tsukai, M., Okumura, M.: Evaluation of Rail/Air Network Considering Alternate Paths, Journal of JSCE Infrastructure planning, pp. 47-56, 1994
- [3] "Institute for Transportation Policy Studies, 2006" [Online], [http://trans.civil.ibaraki.ac.jp/hirata/80yai\\_hirata.pdf](http://trans.civil.ibaraki.ac.jp/hirata/80yai_hirata.pdf)





## SUSTAINABLE URBAN MOBILITY PLANS

Davor Brčić, Marko Šoštarić, Dino Šojat

*University of Zagreb, Faculty of Transport and Traffic Sciences, Croatia*

### Abstract

Urban areas globally, and especially the ones of the European environment, face a great amount of challenges today: the economic crisis, climate change, transport system relying on fossil fuels, and the health risks caused, directly or indirectly, by transport. Increasing transport demand produced by several factors burden the existing urban transport system with more demanding solutions. The existence of a need for increasing mobility to satisfy traffic demand, along with space, energy, environment and financial issues requires a new approach in resolving urban transport problems of the world. Therefore, a new transport policy vision requires redefining the existing urban transport strategy in a way that traditional strategic approach in transport planning shifts to the integrated traffic planning. The European Commission adopted transport strategy, “Action Plan on Urban Mobility” in 2009. As a consequence, sustainable urban mobility plans (SUMP – Sustainable Urban Mobility Plan) have been implemented in several European cities. Croatia is at its beginnings in developing sustainable urban mobility plans. The paper will present the European planning documents related to urban mobility, the purpose and objective of planning and the development of sustainable urban mobility plans in the European cities.

*Keywords: transport policy, sustainable urban mobility plan, European Union, transport strategy, sustainable urban transport system*

### 1 Urban traffic

The global urbanization trend and the economy prosperity of cities generate the induced transport demand in daily migrations. The questionable urban mobility is becoming a fundamental issue in the cities worldwide, especially the developing cities. The existing liability models in cities (in terms of economy, environment, space, energy and society) are becoming unsustainable, especially in long-term periods. The urban areas are especially burdened due to the excessive private car usage. The significance of public spaces for the citizens (in terms of pedestrian and cycling infrastructure, green urban areas, recreational areas, etc.) becomes essential for the future city prosperity. The private car usage generates transport demand, which produces the ever-increasing external costs in urban communities. The rational traffic demand reduction of private car arises as an imperative, since the external costs of the local community are a result of the increased private car usage, in form of increased traffic congestion, noise, air pollution, health issues, road accidents, decreased population density and uncontrolled suburban sprawl. When considering city development, the excessive private car usage in daily migrations causes a regressive investment policy, which consumes significant financial assets for the investment in construction and maintenance of road infrastructure. The examples of the developed cities, which tried to resolve the problems by building additional road infrastructure, suggest that the described problem could not be solved in this manner. The additional roads actually induced additional road traffic, which created even higher deficit in terms of capacity in the near future.

The experts concluded that the change in the current traffic doctrine is essential for the change in modal split of city trips, especially the motorized modes of transport. The solution for the urban traffic system had more relations to politics instead of traffic engineering. Therefore, considering a new traffic doctrine, the urban traffic system is seeking new goals such as sustainable traffic system, better quality of life, social equity and social integration [1].

The challenges of the existing urban traffic system are big because, in addition to daily migrations caused by mobility by gravity, the most interurban transport ends in urban areas [3]. The cities in the European environment consist of 70 % of total population, and contribute by 85 % of GDP in the European Union. In addition, the cities are responsible for 70 % of the greenhouse gas emissions (GHE: 40% CO<sub>2</sub> and 70% of other pollutants) on global scale [2, 3]. In this manner, the responsibility of politicians on national, regional and local level and the local administration in solving transport problems is even higher and more significant [3], since without an efficient and sustainable transport system in urban environment and its gravitational areas, there is no prosperity – neither in economy, nor in environment, space, energy consumption and society.

## 2 Transport strategy of the European Union

The adoption and the and the conduction of traffic policy on the European level (European Union Traffic Policy) is a demanding task. The European Union recognized that the cities, i.e. urban communities have to be a fundamental priority when solving transport problems in terms of number of residents, population density, economy and traffic.

Therefore, based on the first transport strategy of the EU (WHITE PAPER 2001; European transport policy for 2010: Time to decide), the European Commission adopted the following documents (by recognizing and taking into account and the extent of problems caused by traffic in urban areas): GREEN PAPER 2007; “Towards a new culture for urban mobility” [2], and eventually, the “Action Plan on Urban Mobility 2009.” [3]. The stated documents put the focus on traffic issues in the urban environments of the EU.

Following the transport strategy of the 2001 White Paper, the EU Commission introduced the WHITE PAPER 2011; “Roadmap to a Single European Transport Area – Towards a competitive and resource efficient transport system” in 2011 [4]. In accordance with the previous determination on solving the urban traffic issues as a priority, and based on the already introduced “GREEN PAPER” from 2007. and “Action Plan on Urban Mobility” [3] from 2009., the European Union introduced several documents in 2013: “Together towards competitive and resource-efficient urban mobility” [8], “A Concept for Sustainable Urban Mobility Plans” [9], “A call to action on urban logistics”[10], and “Targeted action on urban road safety”[11]. All these documents offer concepts for solving urban transport problems.

In an effort to make the conduction of the transport policy in EU cities operational, the Commission conducts a series of activities by projects supported by the EU funds. Some of these projects are: “CIVITAS”, program “7th RTD Framework Programme”, “European Innovation Partnership (EIP) Smart Cities and Communities”, “Intelligent Energy Europe programme (STEER)”, “The urban dimension in Community policies”, “CLARS” platform, project “Do the Right Mix”, project “European Mobility Week”, and, following the “7th RTD Framework Programme”, the “HORIZON 2020” program. With the activities, projects and funds stated, the Commission conducts the transport policy in the urban areas of the EU state members strongly, efficiently and vigorously.

## 3 Analysis of concepts for creating urban transport plans and their goals

When considering the concept for creating sustainable urban mobility plans, the first action is to refer to the framework determined by the Urban Mobility Package [6], which consists of the actions stated below:

- Definition of the purpose and the goal – SUMP has to enable the accessibility of the urban space while ensuring a high-quality transport system with the “functional city” as a goal.
- Definition of a long-term vision and a clear implementation plan which has to define the future development of mobility, infrastructure and services, with short-term implementation plans, implementation period, clear responsibility delegation and the identification of the financial and other resources necessary.
- Estimation of the existing and future needs, with clearly determined goals related to the SMART goals. (S – specific, M- measurable, A – achievable, R – relevant, T- time-limited)
- Well-balanced integrated development of every transport mode: public transport, cycling, walking, intermodal journeys, road safety, road transport, mobility management and the ITS implementation.
- A good horizontal and vertical integration in terms of cooperation on the national, regional and local level, and the cooperation on the local level with every urban mobility stakeholder.
- A participation approach within the development and the implementation of the plan with the users – citizens.
- Continuous monitoring of plan conduction, with audits and reporting if necessary.
- Quality ensuring by creating mechanisms for a high-quality and properly-evaluated plan.

Therefore, the stated framework certainly has to be taken into account when analysing local urban problems, and the guidelines also have to be included during the determination of the purpose and the goals of the Sustainable urban mobility plans. It is clear that the purpose and the goals will be specific and related to the local conditions; however, the determination of goals also needs to consider the following 10 basic principles of SUMP development:

- The planning of a “humane city”, which has a proper population density,
- Optimization of the road infrastructure by using ITS,
- The development of a city oriented on public transport,
- The development of non-motorized modes of transport – walking and cycling,
- The implementation of improvements for integrating public transport,
- Monitoring vehicle usage,
- Parking supply management,
- The promotion of clean vehicles,
- The implementation of communication solutions,
- A comprehensive approach to the challenges and problems.

## 4 The indicators of a sustainable urban transport system

The definition of the indicators related to the strategies and measures of a sustainable transport system in the urban environment is neither simple nor easy task. There are a series of indicators which are related to the sustainable transport system, but the crucial are the dominant ones. When considering the indicators, the important is not to repeat them, and that they are relevant, measurable, and available. In terms of urban mobility, the expectedly relevant are the following indicators:

- Availability of mobility and space supported by a high-quality infrastructure,
- Quality of infrastructure: safety, comfort, and security (in terms of user experience)
- Costs and the cost availability
- The impact on the environment and health
- The impact on the economy in general (through investments and tax policy)

The availability of mobility for users is the availability of several modes of transport for different social categories of residents in the total mobility. There is a series of indicators which closely determine the indicators of availability of mobility and space: modal split, travel time



(by purpose), trip length (by purpose), and land-use indicators. The quality of infrastructure and safety, comfort, and costs are divided into following indicators: quality of infrastructure, easiness and comfort while using a mode, safety, security, cost availability, etc. The indicators related to economy are investments, operating costs, pricing policy, etc. The indicators related to the environment and health are divided into: air pollution indicators, resource expenditure indicators, health risk indicators and others. Indicators related to the economy policy in general are: finance potential for funding the Plans and the allocation of funds by tax policy and financial measures on the national, regional and local level.

## 5 Strategies and measures for a sustainable urban transport system

According to Böhler; Hüging: Urban Transport Energy Efficient, GIZ GmbH, Berlin 2012 [5], the strategies which are implemented by traffic and other experts when developing a concept of sustainable urban transport system (i.e. conditionally sustainable transport system in terms of energy) can be categorized as one of three global strategy groups: Avoid/Reduce, Shift/Maintain, and Improve. Fig. 1 shows the concept of a sustainable urban transport system as an A-S-I approach.



Figure 1 The concept of a sustainable urban transport system – the A-S-I approach [5]

Avoid/Reduce is the avoiding or reducing the need for travel, in which the purpose and the objectives are achieved with the help of various instruments (by using planning, regulations, economy, information technology). Shift/Maintain is the achievement of a shift to the energy efficient modes of transport by using public transport and non-motorized modes of transport, which cost less per passenger transported while being rational in terms of space consumption. The goals can be achieved by using various instruments (by using planning, regulations, economy, information technology, and urban transport technology). Improve is the improvement of the vehicle energy efficiency by applying technology achievements, in form of less fuel consumption per kilometre crossed, the implementation of technology improvements, reduction of GHE per kilometre crossed, and the improvements in vehicle fleet management. This can be done by using information and technology instruments. According to the strategies stated above, there is a series of measures implemented in order to achieve the purpose and the goals set. The measures are grouped into five fundamental instruments:

- Planning instruments (urban space management – space and traffic planning)
- Regulation instruments (pollutant emission standards, safety, speed limitations, parking policy, space reallocation, etc.)

- Financial instruments (fuel tax, zonal charging, car park charging, green zone charging, public transport subsidizing, etc.)
- Information instruments (public mobility management campaigns, marketing, and the promotion of the sustainable modes of transport)
- Technology instruments (fuel efficiency improvement, implementation of clean vehicle technologies, implementation of ITS for the transport system optimization, etc.)

## 6 Instead of conclusion

The goal of the paper was to point out the need to change the approach in space and traffic planning of urban areas to the professional community, based on the concise analysis of the regulation framework, the concept of a sustainable transport system, its indicators and the analysis of strategies and measures for a sustainable urban transport system. It has become obvious that the countries in the European environment can be divided into three groups [5]:

- Countries that conduct activities on introduction and implementation of Sustainable Urban Mobility Plans based on their national transport policy (Italy, France, Germany, Belgium, The Netherlands, United Kingdom, Norway),
- Countries that are making efforts and conducting activities for the adoption of the Sustainable Urban Mobility Plans (Spain, Portugal, Austria, Slovenia, Hungary, Poland, Sweden, Finland, Estonia)
- Countries that have not adopted the sustainable mobility approach on their national level (Croatia, Czech Republic, Slovakia, Romania, Bulgaria, Greece, Latvia, and Lithuania)

Instead of a conclusion, the paper presents a statement – it is necessary to make efforts in developing a Sustainable Urban Mobility Plan for the Republic of Croatia as soon as possible, because, besides the systematic approach in solving urban transport problems, a Plan will be a condition for granting EU funds intended for the development of sustainable urban transport systems.

## References

- [1] Penalosa, E.: The Role of Transport in Urban Development Policy, GTZ GmbH, Germany, Eschbom 2002., revised July 2005.
- [2] EU Commission: GREEN PAPER; Towards a new culture for urban mobility, Brussels, 25.09. 2007.
- [3] COMMUNICATION FROM THE COMMISSION TO THE EUROPEAN PARLIAMENT, “Action Plan on Urban Mobility”, Brussels, 30.09.2009.
- [4] EU Commission: WHITE PAPER: Roadmap to a Single European Transport Area – Towards a competitive and resource efficient transport system, Brussels, 2011.
- [5] Böhler, S., Hüging, H.: Urban Transport Energy Efficient, GIZ GmbH, Berlin 2012.
- [6] EU Commission: Annex; A Concept for sustainable Urban Mobility Plans, Brussels 17.12.2013.
- [7] Bohler-Beadeker, S., Kost, K., Merforth, M.: Urban Mobility Plans, National Approaches and Local Practice, GIZ Bonn, Germany, November 2014.
- [8] EU Commission: “Together towards competitive and resource-efficient urban mobility”, Brussels, 17.12.2013.
- [9] EU Commission: A Concept for Sustainable Urban Mobility Plans, Brussels 17. 12. 2013.
- [10] EU Commission: “A call to action on urban logistics”, Brussels 17.12. 2013.
- [11] EU Commission: “Targeted action on urban road safety”, Brussels 17.12. 2013.





## DID CYCLING POLICY AND PROGRAMS ADVANCE CYCLING IN THE CITY OF ZAGREB?

Hrvoje Pilko<sup>1</sup>, Tadej Brezina<sup>2</sup>, Krunoslav Tepeš<sup>3</sup>

<sup>1</sup> *University of Zagreb, Faculty of Transport and Traffic Sciences,  
Department of Road Transport, Croatia*

<sup>2</sup> *Vienna University of Technology, Institute of Transportation,  
Research Center for Transport Planning and Traffic Engineering, Austria*

<sup>3</sup> *City of Zagreb, City Office for Physical Planning, Construction of the City,  
Utility Services and Transport, Department for Roads, Croatia*

### Abstract

Developing cycling traffic helps urban centres to advance sustainable citizen mobility. The reason for researching cycling traffic issues in a beginner city (City of Zagreb) stems from poor safety numbers, an increase in volume, unclear development policy, an inadequate infrastructure and legislation. The question arises, did current cycling policy and programs advance cycling? We analyse the current state of cycling traffic and cycle promotion policy in order to assess the actual impacts of these various interventions on the level of cycling. A comprehensive search of available literature, including data from the City Office, has been made. This review paper suggests that development of cycling traffic requires coordinated programs and a holistic planning strategy which includes all stakeholders. Results could serve as a beacon light for similarly sized beginner cities, especially those who are located in Eastern Europe.

*Keywords: cycling traffic; policy and safety; sustainable urban mobility*

### 1 Introduction

Systematically developed cycling traffic is, along with adequate public transportation, one of the most significant forms of achieving sustainable level of citizen mobility. Certain cities have in the last ten years doubled or quadrupled the number of cycling trips while serious cyclist injuries decreased by 10 to 40 % [1]. Studies [2,3] conclude that main attributes which define a quality cycling infrastructure are: a roadway's physical, functional and operational characteristics (lane width, design speed, manoeuvring space, existence of sharp turns and obstacles), motor vehicle speed, intersection sight distance, presence of intersections and street trees (shading). Experiences of cities and countries under evaluation of cycling traffic policy and program measures are demonstrated in detail by Pucher et al. [1]. A similar framework to study the City of Zagreb (Zagreb) is applied here.

From conducted studies on cycling traffic in Zagreb, one can conclude that the initial research was the critical analysis of the current state. Kelčec-Suhovec [4] presents the possibilities and the general need for considering the development of cycling within the General Plan for Urban Zoning (GPUZ), and the utilisation of the bicycle as a means of commuting. Matos et al. [5] state the importance of city authorities in the development of cycling traffic. Later research emphasises the advantages of cycling for the environment and human health [6], and the need to implement a public bicycle sharing systems (PBSS) [7]. An insufficiently clear development policy, a non-existing systematic monitoring and analysis of the current

state, an increase in volume, a large number of traffic accidents, inadequate infrastructure and legislation, a small number of high quality studies raise the question: Did current cycling policy and programs advance cycling in Zagreb?

This paper aims to review the current state of cycling traffic, its policy and program interventions and assess the actual impacts of these interventions on the level of cycling in Zagreb. For this purpose, a comprehensive search of relevant and available literature has been made. Data from the departments of Urban Development and Traffic were also used. Section number two enumerates known basic cycling data of Zagreb in terms of volumes and safety, while the development of infrastructure, of PBSS, of legislation and of promotional activities are described in section three. Section four draws final conclusions.

## 2 Basic Cycling Data in Zagreb

The administrative surface area of the City and County of Zagreb covers 3,701 km<sup>2</sup> (6.53 % of the Republic of Croatia), and is inhabited by 1,107,623 residents, according to the census of 2011, or 25.84 % of Croatia's population [8]. In 2013, there were 470,787 motor vehicles registered, constituting a motorization rate of 425 vehicles per 1,000 inhabitants [9]. The City of Zagreb covers flat and hilly terrain of 641 km<sup>2</sup>. Planning of cycling traffic began in the 1980s when the first GPUZ was passed. At that point, cycling traffic and provided infrastructure were exclusively oriented toward recreational and sports purposes (e.g. recreational and sports centre "Jarun").

### 2.1 Volume

First official cycling volume data was recorded in 1999 for the purpose of a traffic study [10]. This study showed that only 0.7 % of the daily trips were made by bicycle. It is interesting to note that 51 % of households claimed to have at least one bicycle. In the study performed by ISIP-MG [11], measurement of cycling traffic at 16 locations was carried out, mostly on the city's busiest traffic corridors. Measurements were conducted for one week in April 2010 from 11.00 a.m. to 1.00 p.m. and from 3.00 to 5.00 p.m. (Figure 1.a). Weather conditions were appropriate: it was mostly sunny with dry pavement, but data about air temperatures is not known. Based on these limited measurements, it can be assessed that there is a certain amount of increase in cycling traffic (Figure 1.a). Furthermore, the Faculty of Transport and Traffic Sciences (FTTS) from the University of Zagreb measured cycling traffic at certain locations for the needs of the project CiViTAS ELAN Zagreb [12]. Measurements were conducted for one week in April 2008 and 2012 from 4.00 to 5.00 p.m. Weather conditions were appropriate: it was sunny with dry pavement and air temperatures were normal for this time of year in these areas (Figure 1.b).

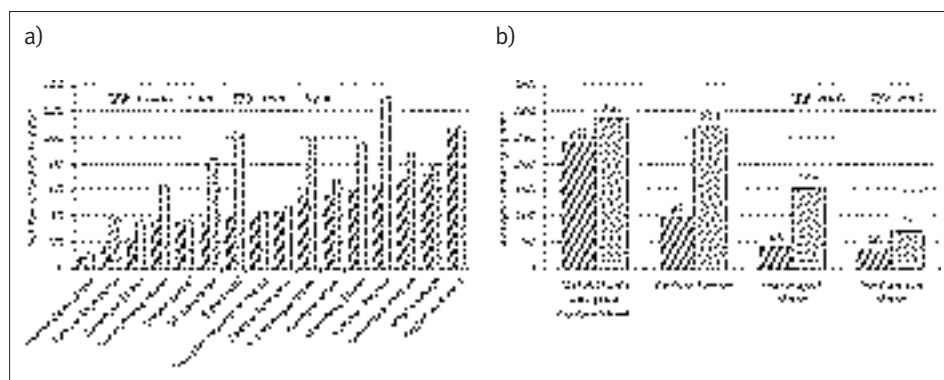


Figure 1 Cycling volume: a) hourly at 16 locations [11] and b) average number at four locations [12]

By comparing the results one can conclude that at the observed locations a significant increase in cycling traffic was recorded between 2008 and 2012, ranging from 17.2 % to even as much as 72.3 %. The PRESTO project in 2010 showed that a third of the students use the bicycle to get to the University on a daily basis [13]. The census from 2011 gathered data on commuting to work/school, but it is not analysed in general and here.

## 2.2 Safety

The Zagreb Police Department is responsible for traffic safety monitoring in the city and county. The data for 2011 and 2015 on the number and consequences of traffic accidents involving cyclists is shown in Table 1. In general, the number of traffic accidents with 355 per year is high. For 2015, in relation to 2011, Table 1 shows a significant reduction in all classifications where the total number of accidents fell by 30.43 %, and fatalities by 85.71 %. According to statistical reports [9], the most frequent causes of traffic accidents involving cyclists are the following: failure to use cycling paths/lanes, riding on sidewalks, and no lights at night.

**Table 1** Number and consequences of traffic accidents involving cyclists in the area of the City of Zagreb from 2011 to 2015 [9]

Number of traffic accidents involving cyclists	Year					Difference 2011/2015 [%]
	2011	2012	2013	2014	2015	
participants	414	404	345	327	288	-30,43
fatalities	7	2	1	3	1	-85,71
injured	297	309	251	242	224	-32,59
seriously injured	84	85	69	90	72	-14,28
slightly injured	229	238	188	157	157	-31,44

## 3 Cycling Policy and Programs in Zagreb

In this chapter only the most significant and latest cycling policy and programs activities are shown.

### 3.1 Administrative framework

Responsible for the planning, implementation and coordination of the cycling traffic program in the city and county is the municipal “Traffic Section” department. This department is responsible for proposals preparation and technical solution regulations of cycling traffic. The broader coordination includes representatives of the Cyclists Union and cycling associations and defines implementation priorities for individual activities. Their activities are: visiting disputed locations and suggesting measures that can therein be implemented; taking part in the design process for the forthcoming reconstructions and building of public traffic surfaces; and analysis of the cycling safety level. So, development and improvement of cycling traffic in Zagreb is focused on interventions that can be listed as follows: the development of cycling infrastructure, implementation of a PBSS, amending legislation for cycling traffic and various educational and marketing activities.

### 3.2 Cycling infrastructure

As of 26<sup>th</sup> of January 2016, there are 138 km of recreational and sports cycling trails on the Zagreb side of Medvednica Nature Park (Figure 2), which sums up to approximately 390 km in total. Technological measures are being taken to further develop cycling infrastructure: low-

ring of curbs and bevelled ramps, adjusting the signal equipment on signalized intersections, marking cycling surfaces red, installing fixed/elastic posts and staplers for the protection of cycling lanes and creating cycling lanes during the reconstruction of important roads. Over 90 % of cycling routes have been arranged as cycling lanes on the walkway of city roads separated from the pedestrians by a yellow line. Only in the city centre on one main longitudinal road a cycling lane was established in the pavement section of the road spanning 1,300 m. Project ELAN [12] resulted in a significant improvement of the cycling infrastructure within the ELAN corridor (Figure 2) and outside of it as well. Thus, 150 parking spaces at 15 locations were introduced within the corridor, while 190 additional parking spaces were introduced outside of it at different points-of-interest (shops, theatres, concert hall, PT stations etc.). In 2015, 212 and in first two months of 2016, 16 bike racks were added at various locations. Within the GPUZ cycling paths are projected to be extended by 5 to 7 km per year. The priority for expansion are directions and branches of the central part which are not adequately interconnected as well as parts where entirety and continuity of a certain direction have not been ensured. In collaboration with the cycling associations a need arose to build the cycling magistral (Figure 2). This would enable an unobstructed connection from East to West. The cycling magistral would be two-way and at least 2.5 m in width. Further extension ~20 km of it is planned in 2016. In 2016, another cycling path 2.0 km long is planned connecting Veliko Polje and Buzin in the south part of the city. Also, Greenway project in 2017 is going to extend another 121 km of cycling paths/lanes throughout the city.

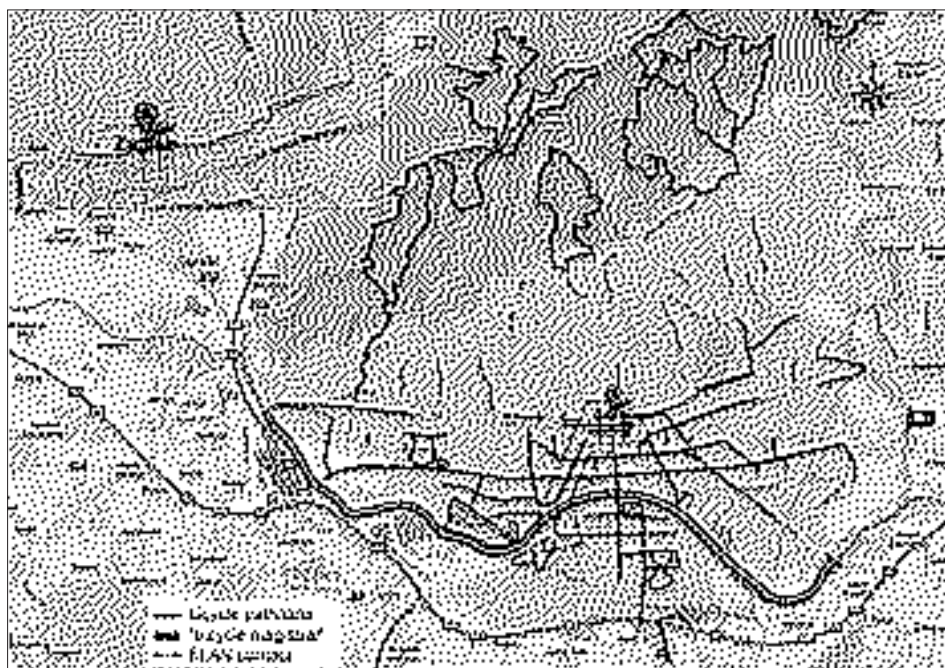


Figure 2 Existing cycling network in Zagreb, 26<sup>th</sup> January 2016

### 3.3 Public Bicycling Sharing System

A PBSS pilot project led by a private partner nextbike was started in June of 2013. At the moment 16 locations with around 100 bicycles are in operation. Bicycle stations have been placed in city locations with highest frequencies of pedestrians. The Studocikl pilot project providing a



PBSS to the University of Zagreb's Borongaj campus was designed and initiated within CiViTAS ELAN [12]. The idea was to provide students and faculty staff easier transportation between the two remote locations of the FTTS. The Borongaj campus currently consists of three faculties with a total of 4,500 students. The FTTS currently has about 1,450 full-time students, 710 part-time students and 179 members of staff. The Studocikl project has three basic features: 20 blue bicycles with logos, two depots (headquarters of FTTS at Vukelićeva Street and at Borongaj campus) for bike disposals and a web portal for login and logout. The service is free of charge for users, and maintenance costs are covered by FTTS. The rentals and disposals can be done during workdays (8.00 a.m. – 8.00 p.m.) and Saturdays (8.00 a.m. – 4.00 p.m.). At Sundays the service is not available. All the bicycles meet the requirements of current Croatian legislation. The web portal is used to monitor bicycle depots in real-time in order to provide information about currently available bicycles and depot occupancy online [14].

### 3.4 Cycling traffic legislation

Existing cycling legislation consists of national legislation: Law on the Safety of Road Traffic (NN 158/13), Ordinance on Traffic Signs, Signalization and Road Equipment (NN 14/11), Ordinance on Ensuring Accessibility of Buildings for Persons with Disabilities (NN 78/13), Ordinance on Basic Conditions to Which Public Roads Outside of Settlements Must Adhere from the Traffic Safety Aspect (NN 110/11), Ordinance on Technical Requirements for Vehicles in Road Traffic (NN 51/10), and local legislation: Decision on Traffic Regulation in the City of Zagreb (SGGZ 23/03) and Decision of Adopting the GPUZ (SGGZ 7/13) [15–21].

The Law [15] defines: cycling areas (paths/lanes), behaviour and movement of cyclists in/on traffic/roads exclusively for motor traffic, the movement of motor vehicles with regard to cycling, and the ability to ride a bike according to age. Management of cycling traffic through the signalization is defined in [16]. Width, clearance of cycling paths and lanes are defined in the regulation [18] as the conditions for setting cycling racks and design of demarcation of cycling paths/lanes from public area is defined in [17]. Technical requirements and traffic equipment that bicycles must meet for safe traffic are defined in the technical guidelines [21]. During this study a new Ordinance on cycling traffic and Ordinance on cycling infrastructure [22] is in the process of public announcement. Review of this legislation should be the subject in next papers.

### 3.5 Promotional activities

The Department's promotional activities consist of financing various educational, and sports activities related to cycling safety and different modes of transport (regulation checks, driving skills, production of cycling maps, manuals and others).

As part of the European Mobility Week, every year expert conventions on traffic safety and sustainable mobility in urban centres are held. The activities are focused on educating citizens and children about traffic culture and to encourage the use of public transportation, bicycles and walking. To promote the cycling culture by organizing targeted educational and promotional activities, in 2012 the Cycling Information Centre was opened. Also in the Centre, there is a European Cyclists Federation (ECF) point where citizens can get current information about their activities and programs [23]. Since 2012 the Cyclists Union has been organizing the bi-annual cycling festival Pedalafest. Being part conference part festival it aims to popularize the bicycle as a means of transport in the city. The program encompasses panels and workshops led by distinguished lecturers from abroad who present concrete solutions for improving the conditions for the use of bicycles as an sustainable and healthy means of transport [24]. Pedalafest also hosts a Critical Mass. In 2015, the "Police on bicycles" initiative was introduced, starting with 18 fully equipped bicycles. Also, the Orange bike ride will be organized at the beginning of May for the first time in Zagreb as a part of European cycling challenge.



## 4 Conclusion

This review sums up the available evidence of a wide variety of cycling policy measures in the beginner city of Zagreb. Sections 2 and 3 show that a lot of policy measures have been introduced. Nevertheless, the crucial limitation is that there is generally insufficient data and before/after research. This is especially true for data on the volume, structure and movement of cyclists on paths/lanes and the state of traffic safety. As a result, these data do not adequately address the direction of causality, such as whether current cycling policy and programs advance cycling or whether cycling demand led to increased levels of cycling. Therefore it's not possible to evaluate which measures and pro-bicycle policy packages are the most effective.

Experiencing cycling in Zagreb reveals that one of the most pressing problems remains the cycling network's discontinuity, i.e. the lack of wholeness, connectedness and compactness. As far as sustainable urban mobility is concerned, cycling traffic in Zagreb is a relatively new area of action. Bearing this in mind, inexperience of all stakeholders is present, especially with the city's executive and its experts. This poses a complex challenge. Results may serve as a basis for the creation of a coordinate and holistic planning strategy for development of cycling traffic in Zagreb. Also, they could serve as a beacon light for similar size beginner cities, especially those that are located in South-eastern and Eastern parts of Europe. The need for further research implies the implementation of: systematic measurement and analysis of volume, structure and movement of cycling traffic; extensive expert studies; improving and extending the existing cycling network; connecting the cycling network with the near-by cities and EuroVelo corridors [25]; upgrading PBSS and preventive activities. Also, the existing cycling-related legislation should be extensively complemented, according to local characteristics and aligned with European recommendations and standards.

## Acknowledgements

The authors would like to thank the City of Zagreb, City Office for Physical Planning, Construction of the City, Utility Services and Transport, Department for Transport and Roads for enabling access to the data-sets, supporting research questions and discussing research findings.

## References

- [1] Pucher, J., Dill, J., Handy, S.: Infrastructure, Programs, and Policies to Increase Bicycling: An International Review. *Prev Med*, 50, pp. 106–125, 2010.
- [2] Providelo, J. K., da Penha Sanches, S.: Roadway and Traffic Characteristics for Bicycling. *Transportation*, 38, pp. 765–777, 2011.
- [3] Brezina, T., Ibesich, N., Niegl, M., Lemmerer, H.: Requirements for High Quality Cycling Infrastructure Design. 2<sup>nd</sup> International Conference Road and Rail Infrastructure, Dubrovnik, Croatia, pp. 953–959, 2012.
- [4] Kelcec-Suhovec, S.: Green Modes of Transport and Traffic Safety – The Zagreb Case. *Proceedings of 9<sup>th</sup> ICTC, Zagreb*, p. 1–5, 1996.
- [5] Matos, S., Krapac, L., Krapac, J.: Cycling in Zagreb. *Acta Medica Croat*, 61, pp. 27–31, 2007.
- [6] Bogović, I.: Cycling as Recreation and Transportation Necessity. *Promet-Traffic&Transportation*, 13, 349–354, 2001.
- [7] Halgota, V.: Planiranje gradskog prometa: Javni bicikli kao dio prometnog identiteta Zagreba. *Diskrepancija*, 10, pp. 61–71, 2010 (in Croatian).
- [8] Državni zavod za statistiku Republike Hrvatske. *Statistički ljetopis Republike Hrvatske. Zagreb: 2013* (in Croatian).

- [9] Policijska uprava Zagrebačka. Stanje sigurnosti u cestovnom prometu na području Policijske uprave Zagrebačke. Zagreb: 2013 (in Croatian).
- [10] MVA. Prometna studija grada Zagreba. MVA; 1999.
- [11] ISIP-MG d.o.o. Biciklistički promet i površine – smjernice za planiranje i regulaciju. Zagreb: ISIP-MG d.o.o.; 2011 (in Croatian).
- [12] Engels, D., Mrvelj, Š., Cauwenberge, Van., Valkova, J., Vilarinho, C., Tavares, P., et al.: CIVITAS ELAN Final Evaluation Report, ELAN Deliverable No.10.11. Brussels: European Commission; 2012.
- [13] Geografski fakultet, Institut društvenih znanosti Ivo Pilar. Planning More Human City: Students Attitudes Towards Cycling and Transport in Zagreb. Zagreb: Grad Zagreb; 2010.
- [14] Šimunović, L., Ćosić, M., Slavulj, M.: Student Bicycle Sharing System in Zagreb – Studocikl. 3<sup>rd</sup> International Conference on Road and Rail Infrastructure, Split, 2014, pp. 961–967.
- [15] Hrvatski Sabor. Zakon o sigurnosti prometa na cestama NN 80/13. Hrvatska: 2013 (in Croatian).
- [16] Ministarstvo mora, prometa i infrastrukture. Pravilnik o prometnim znakovima, signalizaciji i opremi na cestama NN 14/11. Hrvatska: 2011 (in Croatian).
- [17] Ministarstvo graditeljstva i prostornog uređenja. Pravilnik o osiguranju pristupačnosti građevina osobama s invaliditetom i smanjene pokretljivosti NN 78/13. Hrvatska: 2013 (in Croatian).
- [18] Ministarstvo pomorstva, prometa i veza. Pravilnik o osnovnim uvjetima kojima javne ceste izvan naselja i njihovi elementi moraju udovoljavati sa stajališta sigurnosti prometa NN110/01. Hrvatska: 2001 (in Croatian).
- [19] Skupština Grada Zagreba. Odluka o uređenju prometa na području Grada Zagreba SGGZ 23/03. Hrvatska: 2003 (in Croatian).
- [20] Skupština Grada Zagreba. Odluka o donošenju Generalnog urbanističkog plana grada Zagreba SGGZ 7/13. Hrvatska: 2013 (in Croatian).
- [21] Ministarstvo mora, prometa i infrastrukture. Pravilnik o tehničkim uvjetima vozila u prometu na cestama. Hrvatska: 2010 (in Croatian).
- [22] Ministarstvo pomorstva, prometa i infrastrukture. Pravilnik o biciklističkoj infrastrukturi. 2016 (in Croatian).
- [23] <http://mojbicikl.hr/hr/vijesti/klub-bicikl/bic---prvi-biciklisticki-info-centar-u-hrvatskoj,344.html> (April 2016)
- [24] <http://pedalafest.eu/> (April 2016)
- [25] Šimunović, L., Pilko, H., Banožić, M.: Development of National Cycle Route Induced by EuroVelo Cycle Networks – Danube Cycle Route Case Study. *Suvremeni Promet*, 32, 241–247, 2012.



## 6 TUNNELS AND BRIDGES





## THE LONG-TERM BRIDGE PERFORMANCE (LTBP) PROGRAM BRIDGE PORTAL

Hooman Parvardeh<sup>1</sup>, Saeed Babanajad<sup>1</sup>, Hamid Ghasemi<sup>2</sup>, Ali Maher<sup>1</sup>,  
Nenad Gucunski<sup>1</sup>, Robert Zobel<sup>2</sup>

<sup>1</sup> Center for Advanced Infrastructure and Transportation (CAIT), Rutgers University, USA

<sup>2</sup> Turner Fairbanks Highway Research Center, Federal Highway Administration (FHWA), USA

### Abstract

The Long-Term Bridge Performance (LTBP) Program is a 20-year research effort by the U.S. Federal Highway Administration (FHWA) to collect scientific performance field data from a representative sample of bridges nationwide that will help the bridge community better understand bridge deterioration and performance. The products from this program will be a collection of data-driven tools, including predictive and forecasting models, which will enhance the abilities of bridge owners to optimize their management of bridges. The paper describes a key product of the LTBP program, the Bridge Portal, which contains bridge performance-related data mined from existing sources (National Bridge Inventory, State Highway Agency bridge element level data, national weather data, traffic data, weigh-in-motion data, bridge maintenance data, and other data sources), but it also serves as a central repository for all field data collected through the LTBP Program. Additionally, the Bridge Portal also functions as a research and decision-making tool by implementing bridge life-cycle and deterioration modeling using both mined data sources as well as LTBP-acquired field data to allow users to investigate bridge performance on many different levels.

*Keywords: Bridge Portal, National Bridge Inventory (NBI), National Bridge Element (NBE), Bridge Infrastructure Management, Bridge Database*

### 1 Introduction

In 2008, the FHWA launched its largest bridge research effort, the LTBP Program. The LTBP Program is a 20-year research endeavor to collect scientific performance field data from a representative sample of bridges across the U.S. This will assist the bridge community to improve understanding of bridge deterioration and performance. The products from LTBP program will be a collection of data-driven decision making tools, including predictive models. The final outcomes will enhance the abilities of bridge owners to optimize their management of bridges [1].

Bridge performance is a multifaceted problem affected by performance of materials and protective systems as well as individual components of the bridge, and performance of the structural system as a whole. The behavior of any single bridge or element of a bridge is attributed to multiple factors, many of which are closely linked [2].

LTBP Bridge Portal was developed to bridge owners and scientists to get a better understanding of performance of bridges. It is an intelligent web based platform that mines different data set such as Historical National Bridge Inventory (NBI), National Bridge Element (NBE), traffic, environmental, bridge elevation, inspection, and maintenance data as well as data acquired through LTBP field testing. LTBP Bridge Portal utilizes all different mined dataset

to develop advanced forecasting and deterioration models to predict the future condition of bridges. LTBP Bridge Portal is publicly accessible from <https://ltbp6.rutgers.edu> web address.

## 2 LTBP Bridge Portal Datasets

This section explores the different datasets of LTBP Bridge Portal as a web based platform. In particular, the LTBP Bridge Portal provides the bridge information in three main categories, including NBI, NBE, and LTBP program field data.

### 2.1 NBI

With the purpose of having a unified system for bridges and tunnels, NBI has been compiled by FHWA since 1972 to create a novel database. NBI is a comprehensive database system including all the bridges and tunnels passing over/below the road network within the territory of the United States. The database includes more than 100 different characteristics mainly describing the structures' identification information, bridge types and specifications, operational conditions, geometric data and functional description, inspection data, etc. Currently LTBP Bridge Portal houses historical NBI data from 1992 to 2015 and is programmed in a manner to easily provide the detailed information about the status of each individual bridge or tunnel. Every year, at the beginning of February, FHWA provides the collected NBI data for the previous year which are instantly uploaded to LTBP Bridge Portal shortly afterwards. Additionally, NBI reports contain the structural condition of bridges in three main categories of deck, superstructure, and substructure.

### 2.2 NBE

As discussed, NBI provides the condition states only for bridge deck, substructure, and superstructure levels while it lacks detailed evaluation of bridge components. The FHWA and bridge owners nationwide have recognized the benefits of having more detailed element level bridge inspection condition data to better show the severity and extent of bridge condition deficiencies. This results in designing more efficient and successful repair and maintenance plans. In the proposed NBE system, the elements are defined under seven categories, including Deck/Slab, Superstructure, Substructure, Bridge Rail, Joint, Bearing, and Wearing Surface and Protective Coatings. All elements have four defined condition states ranking from good to serious condition. Starting from 2015, it is mandatory for all states to submit their NBE data to FHWA. Shortly after this data is publicly available on FHWA website, it will be transferred to LTBP Bridge Portal.

### 2.3 LTBP program data

Under the LTBP program, the scientific performance field data from a representative sample of bridges nationwide are collected to provide the bridge community with a better understanding of bridge deterioration and performance. The LTBP acquired data will be stored on LTBP Bridge Portal. The following data types are being collected and recorded from the selected bridges, followed by brief description for completeness:

#### 2.3.1 Non-Destructive Testing (NDT)

Per the main objective of the LTBP Program, five different NDT techniques are employed on selected bridges in order to follow the deterioration and performance of bridge decks over the time spatial. The tests include Impact Echo, Ultra Sonic Surface Wave, Ground Penetration Radar, Half Cell Potential, and Electrical Resistivity.

### 2.3.2 Visual inspection

In addition to NDT data, LTBP program collects detailed visual inspection data from bridges and store them on LTBP Bridge Portal.

### 2.3.3 Bridge Weigh in Motion

Bridge Weigh-in-Motion (BWIM) is a technique which uses an existing bridge to weigh trucks while they are moving at full highway speeds. Different sensors are installed on bridge girders to measure the response of bridge components as the vehicles crossing over the bridge. The real-time outcomes of the BWIM system are fourfold: 1) providing each passing vehicle's individual axle weights, gross vehicle weight, time and lane of passage, 2) providing the vehicle speed as well as axel classification, 3) pre-selection of overweight trucks for enforcement purposes, 4) calculation of Average Daily Traffic (ADT) data for individual and/or all lanes of bridge.

## 3 LTBP Bridge Portal Main Components

Besides the capability of LTBP Bridge Portal as a central repository for NBI, NBE, and LTBP Program data, it provides specific components to improve the existing knowledge of bridge performance. These Modules include deterioration modeling, data management toolboxes, and a set of complementary features; following is a brief description for completeness:

### 3.1 Deterioration modelling

Deterioration Modeling is an important part of bridge management and in order to maintain the inventory of bridges with optimal cost, bridge owners need to know how bridges deteriorate.

LTBP Bridge Portal uses advanced statistical methods to develop deterioration models for bridges. The expected condition-rating curve of a bridge is generated in two steps: 1) modeling, which generates the deterioration models for the said bridge; and 2) prediction, which utilizes the deterioration models to generate the curve. In order to predict the future condition of bridges, LTBP Bridge Portal uses Weibull models.

This process is solely based on the data, every year after new data is mined and new NBI and NBE is imported to the LTBP Bridge Portal, the system will update the available condition predictions for bridges and represent the data.

### 3.2 Data management tools

LTBP Bridge Portal has advanced capability for mining data from different data sources, storing the data in highly customized and optimized database, searching and retrieving data.

The database is optimized for optimum speed using the state of art method optimization techniques including normalization, denormalization and indexing. The tables in the Database are connected in a way that storing very large longitudinal datasets are possible but searching the system will be very quick. The most complicated queries will take less than 5-6 seconds to perform.

In addition, there is an advanced document management and file server which is used to host all LTBP field data as well as bridge documentation.

### 3.3 Advanced features and functionalities

In addition to data management and deterioration modelling functionalities described above, LTBP Bridge Portal comprise numerous functionality which enables users to query and visualize data in different ways. Below are a list of the most important functionalities with a short description of each:



### 3.3.1 Advanced search

LTBP Bridge Portal utilizes a state of the art search capability which is not only very easy to use but also extremely quick. The search boxes use auto completion so the user can fill the forms by only spelling part of a word. Upon execution, the search query is translated to a JavaScript Object Notation (JSON) object which will be transferred to different page for optimized performance. Users can perform any search on any field of the datasets available in the system.

### 3.3.2 GIS

LTBP Bridge Portal features a very advanced GIS module which is capable of rendering up to 150,000 bridges on the map. Each bridge is represented by a circle and user can change the size and color of the circles based on different attributes. For example it is possible to associate the size of circles to the traffic of the bridges and the color of bridges to the deck condition and observe if there is any relationship between the two. The map feature is developed using advanced WebGL technology and is only supported by web browsers that are developed after 2014.

### 3.3.3 Multi-Dimensional charts

In order to visualize the data, LTBP Bridge Portal offers different visualization methods, these include one dimension bar chart, pie chart, and donut chart and multi dimension bar charts. Using these charts, it is possible to quickly visualize the data based on different factors and discover particular trends in the data.

### 3.3.4 Historical trends

As explained before, LTBP Bridge Portal database keeps all historical NBI and NBE information. This includes historical condition and traffic data. Users can observe how the condition of a certain bridge changes through different years and using other methods available in the system, she can get an understanding of the factors that caused the change in the condition. LTBP Bridge Portal also visualize these trends in state level for different categories of bridges (e.g. state or locally owned bridge) which can be used by states to get a deep insight into the effectiveness of their rehabilitation and maintenance practices.

## 4 Case study

In this section, a brief case study is employed to introduce an example of LTBP Bridge Portal application. Here it is intended to select bridges with age of less than 20 years which are located in North-East of U.S., being in poor or worse deck condition.



Figure 1 Search view, including the selected criteria with defined constraints

First, the advanced search is being employed to add the filters and set the constraints. Fig. 1 pertains to the LTBP Bridge Portal advanced search indicating the applied filters with designated constraints. After executing the search, user can see the result in a tabular format from the results page. Fig. 2 shows the schematics of the results page. Next, the data is visualized on the map, each circle is representative of a bridge. Fig. 3 shows the resulting bridges on the map.

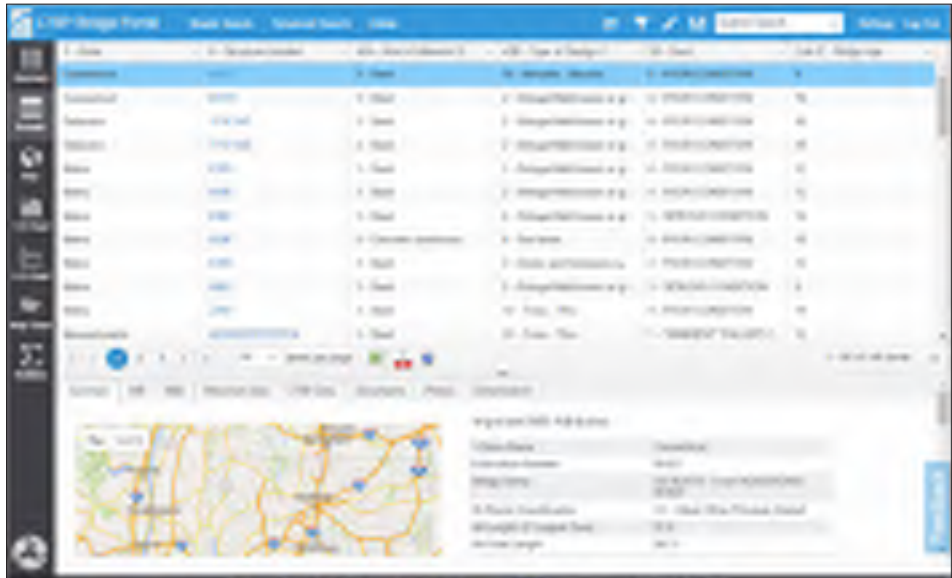


Figure 2 Results page showing bridge information in a tabular format



Figure 3 Bridges are shown on the map; color of each bridge corresponds to the material kind used in the bridge

In the following, the charting capabilities of the system is utilized to visualize the data based on different factors. Fig. 4 shows the number of bridges per state and Fig. 5 demonstrates the number of bridges per structure design and material type.



Figure 4 1-D chart, a bar chart displays the number of bridges in each state



Figure 5 2-D chart, comparing the distribution of selected bridges based on material kind and structure design

## 5 Conclusions

In the work described herein, the basics of LTBP Bridge Portal is discussed. The LTBP Bridge Portal is a key product of LTBP Program which is a research effort by the FHWA to collect scientific performance field data from a representative sample of bridges nationwide. The basic components as well as advanced features of the platform was introduced to map a clear vision for bridge experts. The application of LTBP Bridge Portal was then described by an example of case study. For the case of study, the LTBP Bridge Portal was employed to select bridges with age of less than 20 years in North-East U.S., having a poor or worse deck condition. The outcomes of the case study were then portrayed using different toolboxes implemented in the system.

## References

- [1] What is LTBP Federal Highway Administration, U.S. Department of transportation, [www.fhwa.dot.gov/research/tfhrc/programs/infrastructure/structures/ltbp/](http://www.fhwa.dot.gov/research/tfhrc/programs/infrastructure/structures/ltbp/)
- [2] Brown, M. C., Gomez, J. P., Hammer, M. L., Hooks, J. M.: Long-Term Bridge Performance High Priority Bridge Performance Issues, Pub No. FHWA-HRT-14-052 , Federal Highway Administration, 2014





## USE OF AIR-COUPLED SENSING IN THE ASSESSMENT OF BRIDGE DECK DELAMINATION AND CRACKING

Nenad Gucunski<sup>1</sup>, Seong-Hoon Kee<sup>2</sup>, Basily Basily<sup>1</sup>, Jinyoung Kim<sup>1</sup>, Ali Maher<sup>2</sup>

<sup>1</sup> Rutgers University, United States of America

<sup>2</sup> Dong-A University, South Korea

### Abstract

Air-coupled acoustic sensing opens opportunities to dramatically increase the speed of data collection. The evaluation of feasibility of air-coupled sensing led to the development and implementation of a prototype air-coupled ultrasonic system (ACUS) for simultaneous collection of impact-echo and surface wave data in concrete bridge decks. The basic sensor unit of ACUS is a hexagonal air-coupled sensor array, which includes a solenoid-driven impact source at the center and six air-coupled sensors (ACSs) with parabolic acoustic reflectors (PARs) at vertices of the hexagon. Primary interests of air-coupled acoustic testing are related to detection of delamination using impact echo (IE), and measurement of concrete modulus and evaluation of depth of vertical cracks using surface wave testing. The performance of the hexagonal array was evaluated on a validation bridge containing numerous artificial defects (delaminations, surface-breaking cracks, segregated aggregates, partially grouted tendon ducts, and accelerated corrosion test regions). The results from performance evaluation on delaminated and cracked sections of the validation bridge are presented.

*Keywords: bridge decks, delamination, cracks, impact echo, surface waves, air-coupled sensors, microphones*

### 1 Introduction

Two problems of high concern in deterioration of concrete decks are development of delamination and vertical, surface breaking cracks. Delamination is most commonly caused by rebar corrosion, but it can be also induced as a result of repeated overloading, freeze and thaw action and other sources. Similarly, vertical cracks can be a result of corrosion, concrete shrinkage and other causes. Delamination and vertical cracks are illustrated in Figure 1. As shown in the figure, vertical cracks can propagate to any depth, while delaminations are generally horizontal cracks of a varying depth.

Delamination has been most effectively evaluated using impact echo (IE) method [1, 2]. However, in actual surveys of reinforced concrete components, especially bridge decks using contact sensors, a lower test production rate and somewhat inconsistent coupling conditions are encountered. Both issues can be effectively improved by using contactless or air-coupled sensors (microphones). Previous studies have demonstrated that air-coupled sensors are effective in improving signal consistency and test speed in IE testing [3, 4, 5].

The following sections discuss the use of air-coupled sensing in evaluation of delamination and characterization of vertical cracks with respect to their depth. The first part of the paper discuss the basics of air-coupled sensing and use of parabolic reflectors to enhance the signal. The second part illustrates air-coupled sensing by presenting results from delamination and vertical crack surveys.



**Figure 1** Vertical crack on the surface of a bridge deck (left), a core with a vertical crack (middle), and a core with a vertical crack and delamination (right)

## 2 Air-coupled sensing and parabolic acoustic reflectors

Air-coupled acoustic sensors (measurement microphones) have many advantages. However, because of a low microphone sensitivity, the signal analysis is often complicated due to low signal-to-noise ratios of the sought signal. Several issues need to be overcome. One of them is a commonly weak signal as a result of a large impedance difference between the air and concrete, resulting in significant energy losses between the source and receiver. The other common problem is often present traffic noise in actual field testing, mostly at frequencies less than a few kHz. To improve the sensitivity of an air-coupled sensor (microphone), is by using a parabolic acoustic reflector (PAR) [5, 6].

A typical wave field during air-coupled testing with PAR is illustrated in Figure 2. The image represents a snapshot of a finite element simulation using finite element program ABAQUS. The generated wave fields are a result of application of an impact on the surface of a concrete plate. The movement of the plate surface as a result of propagation of impact induced stress waves will lead to generation, or “leaking”, of acoustic wave energy into the interfacing air. One of the dominant components of the response to an impact will be first symmetrical Lamb mode ( $S_0$ ), which in this case will correspond to the frequency of oscillations for the full plate thickness. The resulting periodical waves can be observed in the figure. The second dominant waves are leaky surface waves, which represent leakage of the surface waves in the plate into air. According to the Snell's law, and based on the typical surface wave velocity in concrete, and compression wave velocity in the air, the leaky angle is about eight degrees. The third marked component represents the direct acoustic wave as a result of the impact. Finally, some higher air-pressure waves can be observed within the PAR.

Parabolic acoustic reflectors (PARs) were introduced to improve the signal-to-noise ratio of the signal. The PARs operate under the assumption that any incident plane wave parallel to the axis of the parabolic surface is reflected toward the focal point. Because the length of the wave paths to the focal point are the same, the acoustic waves of the same frequency will be in phase at the focal point. Therefore, the use of parabolic reflectors can effectively enhance the valuable stress-wave components in the air-coupled IE testing. An extensive numerical and experimental study was conducted to evaluate the effect of the size, shape and position of the PAR on the air-coupled IE testing [7]. As shown in Figure 3, for evaluation of concrete slabs of about 200 mm thickness, an optimum PAR diameter is about 150 mm, and the rim angle should be about ninety degrees. The PAR should be within a distance equal or slightly larger than the plate thickness. Within that distance, the signal of the first symmetrical Lamb mode will be fully in phase.



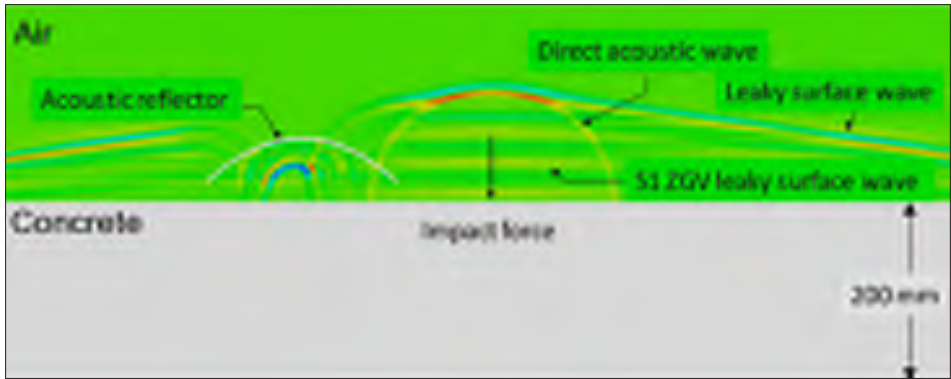


Figure 2 Snapshot of the air-pressure field generated by an impact on the surface of a concrete plate

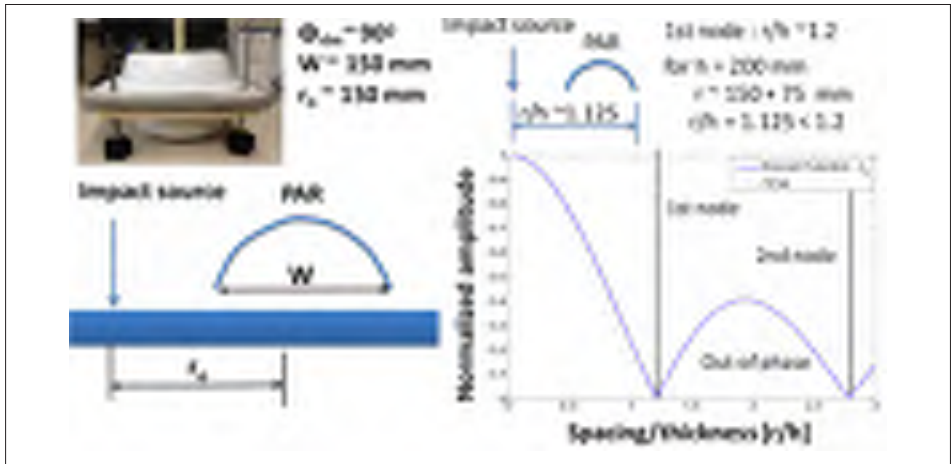


Figure 3 Optimal parameters for the PAR



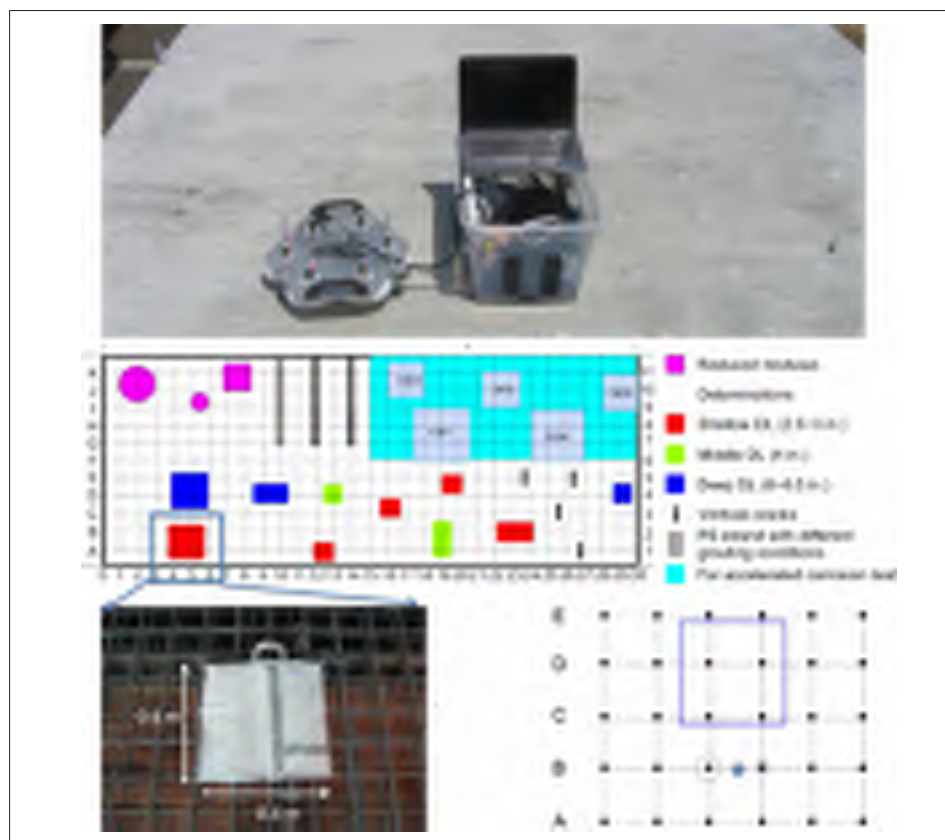
Figure 4 Hexagonal air-coupled acoustic array: parabolic reflectors with microphones and an impact source in the center (left), and application of the array in evaluation of a concrete dam



Six PARs with acoustic sensors (microphones) in their focal points were assembled into a hexagonal acoustic array configuration, as shown in Figure 4. The hexagonal arrangement was selected to enable building of larger arrays from the same units. However, the unit itself can be used as an independent system for delamination detection using impact echo principles, and for depth estimation of surface breaking cracks using surface wave testing principles. Both applications are illustrated later. The unit consists of six PARs of a 150 mm diameter and a linear solenoid type impact source in the center of the array. In the case of surface wave testing, a source outside the perimeter of the hexagonal array needs to be used. The radial distance between the source and microphones is 150 mm. The height of the PARs can be varied. However, the system is typically used with the distance between the surface of the tested element and microphone from 60 to 80 mm.

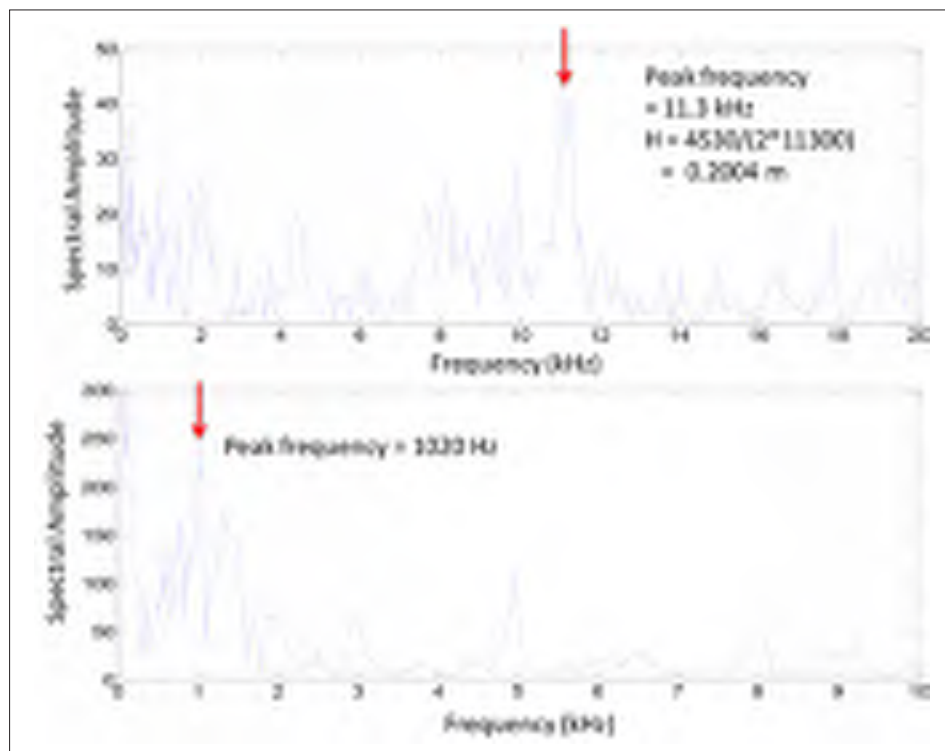
### 3 Delamination and crack assessment by hexagonal array

The implementation of the hexagonal acoustic array is illustrated by the results of delamination and vertical crack evaluation on the Rutgers Validation Bridge (RVB). The RVB is a bridge structure 9 m long, 3.6 m wide, with a reinforced concrete deck 20 cm thick supported by three steel girders. The deck has numerous embedded artificial defects: delaminations, vertical cracks, ducts of various type and grouting conditions, concrete segregation, and an area undergoing accelerated corrosion. Types of defects embedded in the deck are shown in Figure 5.



**Figure 5** Hexagonal air-coupled acoustic array on the validation bridge (top), schematic of embedded defects and deterioration in the bridge (middle), and the delamination evaluated (bottom)

The array was used in evaluation of a delamination of 0.6 m by 0.6 m, and about 7 cm deep. The survey was conducted by moving the center of the hexagonal array in 0.3 m increments in both longitudinal and transverse directions. As illustrated in Figure 6, the dominant frequencies in the spectra of the response of the deck to an impact, clearly point to frequencies describing a sound and delaminated deck. The sound deck condition is established when the dominant peak matches the frequency of the first symmetrical Lamb mode. The delaminated condition is recognized through a much lower dominant frequency of flexural vibrations of the upper delaminated section of the deck.



**Figure 6** Frequency spectrum from IE survey at a location with no delamination (top), and a location with shallow delamination (bottom)

A more accurate position and description of a delamination can be achieved by using information from two receivers symmetrically placed with respect to the source [8]. This is illustrated in Figure 7 by a frequency response plot. The receivers in this case were moved in 0.15 m increments. Presentation using information from two receivers clearly points to the position of the center of the delamination, and at the same time describes zones of the delamination away from the center where the dominant response is, as expected, going to be at frequencies corresponding to higher flexural modes.

Finally, the air-coupled acoustic array was used in estimation of the depth of four vertical surface breaking cracks in the deck. The evaluation was conducted by placing two of the array's sensors symmetrically with respect to the crack, and application of an impact in line with the sensors, as shown in Figure 8. The depth of the cracks was estimated using the procedure outlined in [3]. The results provide a generally good agreement between the estimated and actual depth of the cracks, with the actual depth being slightly underestimated.

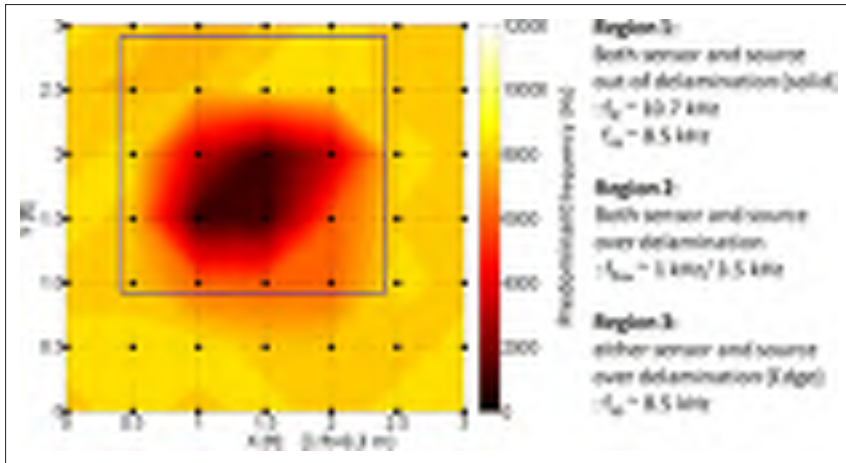


Figure 7 The frequency response surface above and in proximity of a 0.6 by 0.6 m delamination

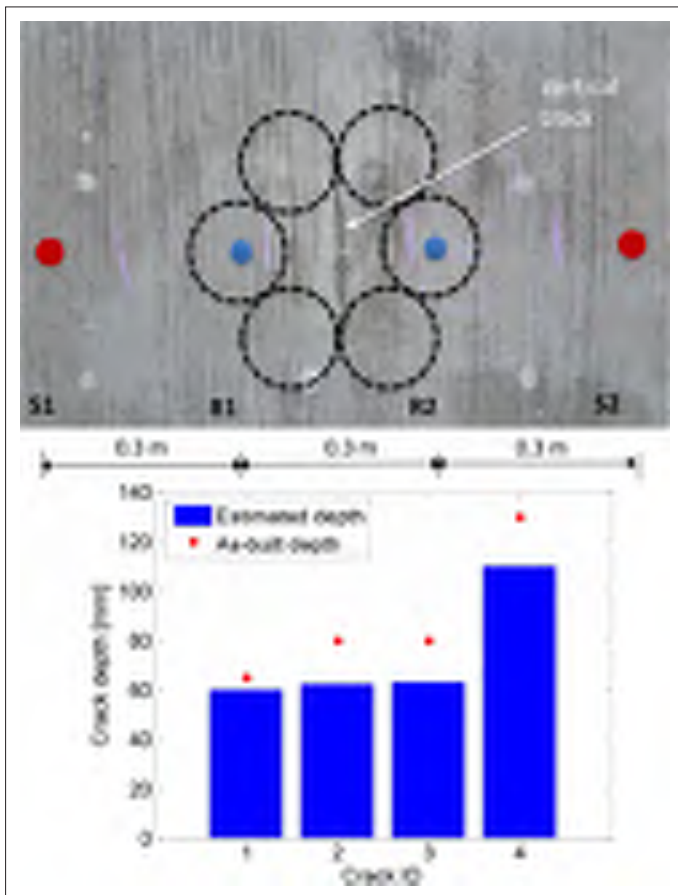


Figure 8 Placement of the acoustic array with respect to the vertical crack (top), and the comparison of estimated and actual depth of cracks (bottom).

## 4 Conclusions

Air-coupled sensing can be effectively used, instead of contact sensing, in the assessment of delamination and vertical cracks. Placement of receivers in an hexagonal arrangement around the source significantly improves the speed of data collection. It also enables a more advanced impact echo analysis from signals of two symmetrically placed receivers with respect to the source, and evaluation of depth of vertical cracks using an external impact source.

## References

- [1] ACI committee 228: Nondestructive Test Methods for Evaluation of Concrete in Structures, Report ACI228.2R-98, American Concrete Institute, Farmington Hills, MI. 1998.
- [2] Sansalone, M.: Impact-Echo: The Complete Story, ACI Structural Journal, 94(71), pp. 777-786, 1997.
- [3] Kee, S. H., Zhu, J.: Using Air-Coupled Sensors to Determine the Depth of a Surface-breaking Crack in Concrete," J. Acoustical Society of America, 127(3), pp. 1279-1287, 2010.
- [4] Zhu, J., Popovics, J. S.: Imaging Concrete Structures Using Air-Coupled Impact-Echo," J. Engineering Mechanics, ASCE, 133(6), pp. 628-640, 2007.
- [5] Rogers, P. H.: A Two-Dimensional Mathematical Model for an Acoustically Soft Parabolic Cylinder Reflector, J. Acoustical Society of America., 53 (3), pp. 890-898, 1973.
- [6] Takashima, R., Takiguchi, T., Ariki, Y.: Monaural Sound-Source-Direction Destination Using the Acoustic Transfer Function of a Parabolic Reflection Board, J. Acoustical Society of America, 127 (2), pp. 902-908, 2010.
- [7] Kee, S.-H., Gucunski, N., Fetrat, F.: Developing an Optimal Acoustic Reflector for Air-coupled Impact-echo Sensor, Proceedings of SPIE's Smart Structures and Materials/Nondestructive Evaluation and Health Monitoring Conference, San Diego, CA, March 11-15, 2012.
- [8] Kee, S.-H., Fetrat, F., Gucunski, N.: Advanced Signal Interpretation Algorithm for Automated Impact Echo Testing System: Application to Concrete Bridge Decks, Proceedings of the 91<sup>st</sup> Annual Transportation Board Meeting, Washington, D.C., January 22-26, 2012.





## INTERACTION BETWEEN CONTINUOUS WELDED RAIL AND BRIDGES WITH RELATIVELY LARGE EXPANSION LENGTH

Otto Plášek<sup>1</sup>, Otakar Švábenský<sup>1</sup>, Hana Krejčířiková<sup>2</sup>, Ladislav Klusáček<sup>1</sup>, Jiří Vendel<sup>1</sup>

<sup>1</sup> Brno University of Technology, Faculty of Civil Engineering, Czech Republic

<sup>2</sup> Czech Technical University in Prague, Faculty of Civil Engineering, Czech Republic

### Abstract




Regarding indisputable savings in maintenance costs continuous welded rail is installed in almost all track sections which are renewed or newly constructed. A need to solve the interaction between the track and bridge preferably without expansion joints has arisen. A complex evaluation of combined response to variable actions is not required according to the Czech national regulation if the track is renewed and the bridge expansion length is within limits. Exceptions are often allowed for bridges whose expansion length exceeds the limits. Good experience supports an increase of limits but theoretical analysis and structure monitoring are desirable. Five bridge structures – steel, concrete, combined and different deck – with ballast, with timbers or direct fastening, had been monitored for three years in all climate conditions. The displacement of track and bridge was surveyed by precise geodetic methods. The longitudinal reactions in bridge fixed bearings were measured for the bridge. Finite element models were built for all the monitored bridges. The backward analyses were carried out for all surveying epochs in the aim to define basic parameters of combined response – bilinear longitudinal resistance of track and the longitudinal stiffness of bridge support. The results serve both to evaluate the parameters defined in European standard EN 1991-2 for ballasted track and to complete the parameters for non-ballasted track.

### 1 Introduction

Nowadays continuous welded rail regarding indisputable savings in maintenance costs is installed almost in all track sections which are renewed or newly constructed. Recently gained experience with construction, service and maintenance of continuous welded rail allows application even in very small radius curves, in which construction of continuous welded rail was not permitted before.

A need to solve the interaction between track and bridge preferably without expansion joints has arisen simultaneously. A complex evaluation of combined response on variable actions is not required according to the Czech national regulation [1] if the track is renewed and the bridge expansion length is within limits. The limits of expansion length were defined based on analyses published in [2]. The analyses comprised both the theoretical description of track bridge interaction and the monitoring of behaviour of selected bridge structures in situ. The mathematical model was based on the linear expression of the track longitudinal resistance in dependence on the track displacements. Other parameters included into the calculation of the track bridge interaction were adapted, eg. equivalent thermal expansion coefficients for different types of bridge structures and bridge decks. The comprehensive assessment system was expressed in the table of admissible expansion lengths, see Tab. 1.

**Table 1** Permissible expansion lengths according to the Czech national standard

Case no.	Arrangement of structures and bearings	Rail	Steel structure, ballasted deck	
			$L_T$ [m]	
			Sleepers	
			wooden	concrete
1		60 E1(2)	110	80
		49 E1	85	60
2		60 E1(2)	108	74
		49 E1	75	51
3		60 E1(2)	61	44
		49 E1	55	40

Very good experience was gained with the design and evaluation procedure defined in the Czech national regulation [1]. As long as the admissible lengths were respected no failures originated from the track bridge interaction have occurred in service over the years. Exceptions are often allowed for bridges which expansion length exceeds the limits. Good experience supports an increase of limits but theoretical analysis and structure monitoring are desirable. The theoretical base of track bridge interaction is described for example in [3], some essential parameters can be found in [4]. The assessment of the combined response of structure and track to variable actions is precisely defined in the UIC Code 774-3 [5] and the Eurocode EN 1991-2 [6] which were issued later on. The European standards comprise only bridges with ballasted deck, rail UIC 60 (60 E1, 60 E2) and track of radius 1500 m and higher. Other bridges still have to be evaluated according to the national annex of the standard or according to the national standards.

The paper is aimed at the monitoring of bridges with relatively large expansion length regarding the national standard [1], particularly in the assessment of longitudinal track resistance.

## 2 Track bridge interaction monitoring

Five bridge structures – steel, concrete, combined of different types of the bridge deck – with ballast, with bridge timbers or direct fastening had been monitored for three years in all climate conditions. The displacement of track and bridge were surveyed by precise geodetic methods. The longitudinal reactions in bridge fixed bearings were monitored for the selected bridge.

### 2.1 Displacement surveying

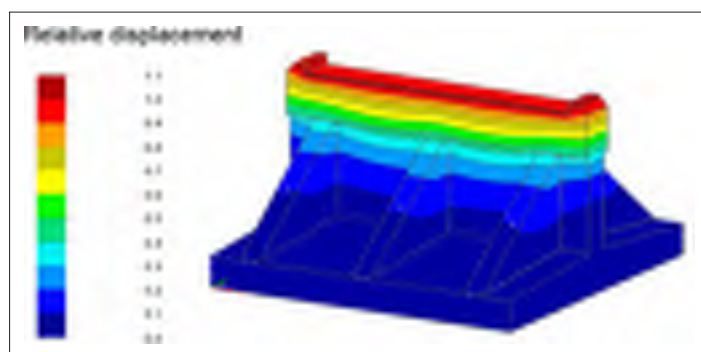
The bridges were monitored for 3 years (2013 – 2015) in 8 geodetic surveying epochs each bridge. 40 surveying epochs in total were carried out on the 5 selected bridges (bridges are numbered for the purpose of this paper):

- 1) Truss bridge, three simple supported decks,  $L_T = 16,0/29,8/16,0$  m (permissible 25 m), overhead open deck, bridge timbers – flat support, rail 49 E1, rail fastening KS (Skl 24)
- 2) Steel bridge, multiple-span continuous deck,  $L_T = 80,3$  m (permissible 60 m), ballasted track, rail 49 E1, rail fastening W14, concrete sleepers
- 3) Steel bridge, simple supported deck,  $L_T = 30$  m (permissible 20 m), floor ballastless deck, direct fastening, rail 49 E1, rail fastening KS (Skl12)
- 4) Truss bridge, simple supported deck,  $L_T = 48,6$  m (permissible 70 m), floor open deck, bridge timbers – centric support, rail R 65, KS (Skl24)
- 5) Composite steel concrete bridge, multiple-span continuous deck,  $L_T = 85,5$  m (permissible 60 m), ballasted track, 60E1, W14, concrete sleepers

Survey points, which were monitored by the terrestrial geodetic method [7], were marked along the bridge length on the both rails as well as on the particular bridge structure. Besides the displacement current temperatures of the rails and the bridge structure were monitored. The rail temperature was measured on four points along the rail cross section. The temperature of the bridge was measured on several points along the height of the structure. Average rail and bridge temperature values for the rails and the bridge were taken into an evaluation. The relative displacement of each point on the both rails and the bridge structure were evaluated in comparison with the state in the initial stage of the surveying. The example of surveying results and its evaluation is presented in Chap. 3.

## 2.2 Longitudinal reactions in fixed bridge bearings

In addition, longitudinal forces acting to the fixed bridge bearings were monitored for the bridge No. 1. They were measured indirectly by strain gages installed on the steel bridge bearings. That is why a static analysis of the bridge bearings by finite element methods was carried out. Dimensions of the particular bridge bearings were measured in site for this purpose. Points, in which the strain gages were installed, had been determined on base of the static analysis, see Fig. 1. This allows recalculation of the strain to the longitudinal forces acting on the bridge bearings.



**Figure 1** FEM analysis of the steel bridge bearing

The strain gages were installed on two fixed bearings of the bridge No. 1 in July 2013. Eight strain gages in pairs were installed in total, but one strain gage was damaged during the measurement. A logger, measuring and recording values of strain and temperature, was inserted into a special steel box hanged on the bridge structure.

The monitoring was carried out continuously until June 2014, when the cables connecting the strain gages and the temperature sensors were destroyed by vandals. Values of the individual gages and sensors were taken every 5 minutes. The monitoring of strain and temperature had been carried out for almost the whole year including the lowest and the highest temperatures periods. The records corresponding to the geodetic surveying was carried out, was evaluated separately. The evaluation of longitudinal forces acting on the fixed bridge bearings were used in numerical analyses to make it more accurate.

The calculated and measured forces have the same tendency. However, differences between predicted forces determined by the numerical analyses and measured forced for some pairs of strain gages were observed. These differences can be explained by bearing clearances up to 5 mm which are asymmetrical on the particular bearing. An asymmetry of acting forces on the bridge structure due to the fact the track on bridge is in curve means another influence. An example of evaluation results for longitudinal forces see in Tab. 2. Calculated forces correspond to the state of the track bridge interaction during the geodetic surveying.



**Table 2** Evaluation of longitudinal forces action on the fixed bridge bearings

Strain gage No.	Measured force [kN]	Calculated force [kN]	Difference [kN]
1	333,04		171,21
4			
2	160,99	161,83	-0,16
3			
6	96,81		-65,02
7			

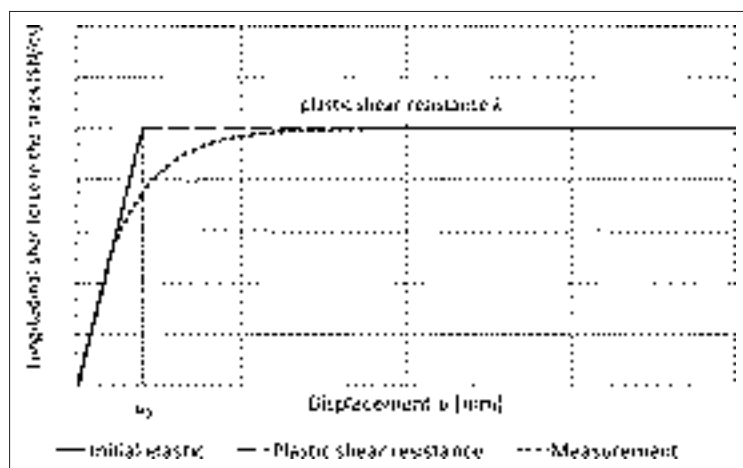
### 3 Numerical analyses

Finite element models were built for all the monitored bridges. Backward analyses were carried out for all surveying epochs with the aim to define basic parameters of the combined response – the bilinear longitudinal resistance of track and the longitudinal stiffness of bridge support. Received results serve both to evaluate parameters defined in European standard EN 1991-2 for ballasted track and to complete parameters for non-ballasted track.

#### 3.1 Finite elements models of track bridge interaction

Due to the fact that the longitudinal displacements caused by the temperature load were monitored, finite element models of track and bridge were built as a 2D beam. Only the effects caused by the extreme temperature changes in summer and winter were analysed. The effect of traction or braking forces and the effect of vertical load were omitted.

The beam elements for the bridge and the track were used in the model. The basic parameters of beam elements: cross section area, moment of inertia, Young’s modulus, temperature and coefficient of thermal expansion. The longitudinal resistance between bridge and track and between embankment and track was modelled as bilinear by special spring elements. The function describing the longitudinal resistance comprises initial elastic resistance [kN/mm of displacement per m of track] and then plastic shear resistance [kN per m of track] defined by displacement  $u_0$  as shown in Fig. 2. The longitudinal resistance was taken into calculations in the value for unloaded track.



**Figure 2** Variation of longitudinal shear force with longitudinal track displacement

The general finite element model shown in Fig. 3 contains besides beam and spring elements also elements representing support stiffness at abutments or pillars. The model allows to take into account any number of parallel tracks or to add or to remove pillars.

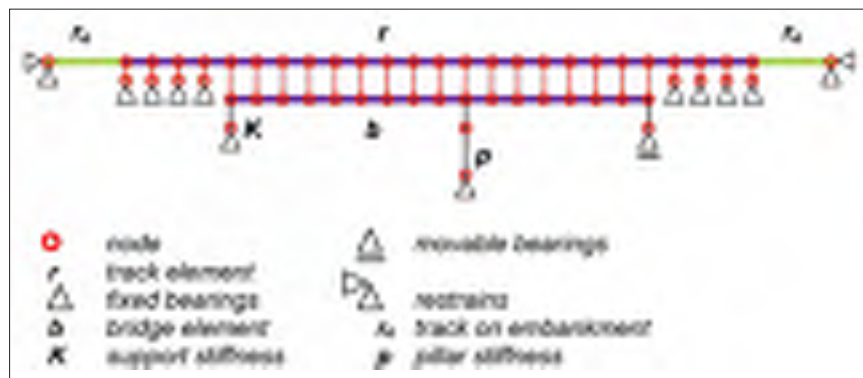


Figure 3 General finite element model of the track bridge interaction

### 3.2 Measured data assessment

The finite element models were used in backwards analyses with the aim to determine parameters of track bridge interaction. In the first phase of results comparison of monitoring and the numerical analyses of the track bridge interaction necessary parameters were used according to the recommendation published in [5] and [6]. In the second phase the parameters were varied by an iterative procedure to reach as close as possible compliance between the measurements and the calculations of track and bridge displacement. Following parameters were varied:

- plastic shear resistance  $k$ ;
- displacement  $u_0$  for which the value of plastic shear resistance is reached;
- coefficient of thermal expansion of the bridge structure  $\alpha_b$ ;
- support stiffness  $K$ ;

The displacement  $u_0$  was varied in the step of 0.5 mm, the value of plastic shear resistance was varied in the step of 5 kN/m. The temperature loads were considered according to the measured values. That meant that for every bridge structure 8 temperature states were assessed and evaluated. The assessment was always carried out immediately after the particular geodetic surveying had been evaluated.

An evaluation example of the track bridge interaction parameters is shown in Fig. 4. The values comparison of the track longitudinal resistance recommended according to the standards and the final estimated values are listed in Tab. 3.

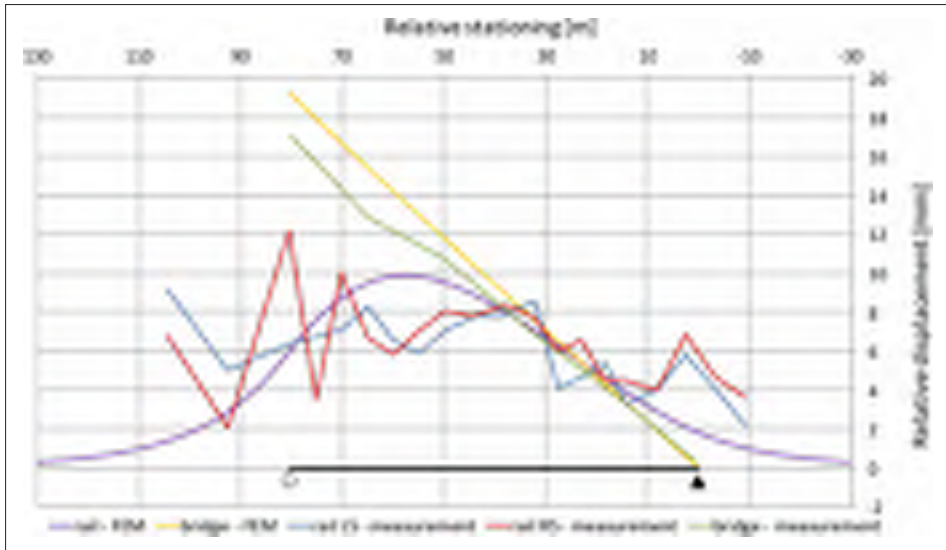


Figure 4 Example of displacements evaluation, bridge No. 2

Table 3 Results of investigation – unloaded track

Bridge structure Bridge deck	Plastic shear resistance $k$		Displacement $u_0$	
	observed [kN/m]	rec. <sup>1)</sup> [kN/m]	observed [mm]	rec. <sup>2)</sup> [mm]
1. Truss bridge Overhead open deck Bridge timbers – flat support	40	–	0,5	0,5
2. Steel bridge Ballasted deck	20	20 – 40	2,0	2,0
3. Steel bridge Floor ballastless deck Direct fastening	40	–	0,5	0,5
4. Truss bridge Floor open deck Bridge timbers – centric support	5	–	0,5	0,5
5. Combined concrete – steel bridge Ballasted deck	10	20 – 40	2,0	2,0

<sup>1)</sup> EN 1991-2, 6.5.4.6.1 Simplified calculation method; <sup>2)</sup> UIC 774-3, 1.2.1.2 Bilinear behavior of the track

## 4 Conclusions

The acquired parameters of track longitudinal resistance, which are essential for the evaluation of track bridge interaction, allow to make analyses of existing or designed bridges more precise. The measured parameters of longitudinal resistance do not differ significantly from the recommended values specified in UIC Code 774-3 and Eurocode EN 1991-2. Acquired knowledge on the track bridge interaction enables a gradual transition from the national methodology of assessment to the methodology according to the European standards for existing bridges with ballastless deck.

The monitoring and the FEM analyses were completed by a simplified mathematical model to calculate combined response. The model was compiled on the basis of the monitoring results and the numerical analyses. The simplified model enables the infrastructure manager to calculate the combined response of the particular bridge design without the need to build a complex numerical model. Results of the presented research provide a tool for a reasoned decision on the installation of continuous welded track on bridges which expansion length is over the current limits specified in the Czech national regulation. The description of the analytical tool is beyond the extent of this paper.

## Acknowledgment

This outcome has been achieved with the financial support of of the Czech Railway Infrastructure Administration, project “Assessment of interaction between track and bridges with large expansion length” and published with the financial support of Technology Agency of the Czech Republic, project No. TE01020168 “Centre for Effective and Sustainable Transport Infrastructure”.

## References

- [1] SŽDC S3 Železniční svršek (Railway superstructure). Regulation of the Czech Railway Infrastructure Administration
- [2] Fryba, L.: Dynamika železničních mostů (Dynamics of Railway Bridges). 1. ed. Praha: Academia, 1992. 328 pp. ISBN 80-200-0262-6
- [3] Esveld, C.: Modern railway track. 2nd ed. Zaltbommel: MRT-Productions, 2001. ISBN 90-800-3243-3.
- [4] Lichtberger, B.: Handbuch gleis: Unterbau, Oberbau, Instandhaltung, Wirtschaftlichkeit. Hamburg: Tetzlaff, 2003. ISBN 38-781-4803-8.
- [5] UIC Code 774-3 R, 2nd edition, 11/2001. Track/Bridge Interaction. Recommendation for calculations
- [6] EN 1991-2 Eurocode 1: Actions on structures – Part 2: Traffic loads on bridges
- [7] Švabensky, O., Plašek, O., Bureš, J.: Railway Track Deformation Surveying Using GNSS Real and Virtual Reference, paper in proceedings of INGEO 2011 Proceedings of the 5<sup>th</sup> International Conference on Engineering Surveying, ISBN 978-953-6082-15-5, University of Zagreb, Zagreb, Croatia, 2011





## ANALYSIS OF THE INFLUENCE OF THE NATURAL ENVIRONMENT ON BRIDGE SOUNDNESS

Takahiro Minami, Makoto Fujiu, Shoichiro Nakayama, Jyunichi Takayama  
Kanazawa University, Japan

### Abstract

In recent years, extending the service lives of bridges has become a topic of discussion. As the bridges built during the rapid economic growth period have reached the end of their service lives, replacing these bridges or extending their service lives are being discussed. Within this situation, local municipal governments are also conducting regular inspections once every five years as part of preventative maintenance, rather than performing corrective maintenance. In this study, we will shed light on which bridges are most prone to rapid deterioration by using data from the regular inspection of bridges. We will do this by calculating the deterioration rate from inspection data from two inspection cycles in order to determine the environmental factors that affect the deterioration rate. In regards to analysis methods, we used Hayashi's Quantification Method Type I to grasp the level of influence each factor has on the deterioration rate.

*Keywords: bridge, maintenance, regular inspection, bridge soundness, natural environments*

### 1 Introduction

Japan currently has around 700,000 road bridges (at least 2.0 m long). As shown in Figure 1, 18% of these were bridges older than the typical 50-year service life of bridges (older bridges) in fiscal 2013. In another 10 years, this percentage is expected to grow to around 43% [1]. As public works spending continues to decrease yearly, within a few years all of the bridges built in great number during the rapid economic growth period will have been in service for more than 50 years. At this point, dealing with the problem of aging bridges point will be infeasible in terms of both human resources and cost. Should these bridges be closed, the road transportation network could be greatly affected [2].

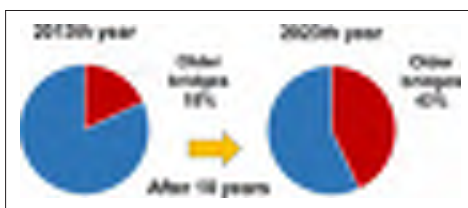


Figure 1 Styles dialogue in Microsoft Word 97-2003 [1]

Given this situation, emphasis has been put on efficient maintenance and operation, and the national government and local municipal governments are engaging in regular inspections of bridges while also actively creating frameworks for asset management. However, there are two main issues with maintaining and operating bridges through regular inspections. The

first is the issue of the inspector's determination of the soundness of the components of each bridge. The second issue is using the data on the soundness of each component to calculate the overall soundness of the bridges as a whole and determine its priority. In this study, we are dealing with the former; the issue of determining priority.

The state of damage (soundness) and importance of a bridge are considered when its priority is determined. In the case of Ishikawa Prefecture, the BHI (Bridge Health Index), an index of the overall soundness of a bridge, is calculated from the soundness of each component. The BHI is a qualitative index calculated through the weighted average method using the soundness of each component and a weight coefficient between the components. The importance of bridges is evaluated using the BPI (Bridge Public Index), an index of bridge importance that comprehensively evaluates the importance of the route and the traffic volume. Calculated using the weighted average method, BPI focuses on the importance of the route (emergency transportation routes, road and railway overpasses) and the traffic volume (by type of traffic), with a weight coefficient established for each. The priority P for bridge maintenance and replacement is determined by a composite value of these two indices, BHI and BPI.

However, these evaluation methods do not consider the environmental conditions surrounding a bridge. Bridges with different environmental conditions are expected to have greatly different rates of deterioration. Therefore, maintenance and operation that does not consider environmental conditions does not allow the priority of bridge maintenance and replacement to be determined in a manner that is appropriate for the rate of deterioration. Therefore, in this study we will statistically analyze the environmental factors which affect the soundness of bridges evaluated in regular bridge inspections using regular bridge inspections data from two inspection cycles.

## 2 Data analyzed

In this study, we analyzed the bridges managed by Ishikawa Prefecture. Ishikawa Prefecture is a harsh environment for bridges due to factors including flying salt caused by the meteorological characteristics of its winters, the dispersal of antifreezing agents primarily in mountainous areas to keep roads passable in winter, and fatigue caused by heavy loads and impacts from vehicular traffic in urban areas with high traffic volume.

### 2.1 Regular bridge inspection data

As shown in Table 1, regular bridge inspection data includes the specifications of the bridges and inspection data. These specifications include the year of construction, superstructure material, bridge length, road traffic census data (daily traffic volume, daily large vehicle traffic volume), location, latitude and longitude, rehabilitation and reinforcement priority, etc. Regular inspections are conducted once every five years, with the items inspected being the main girders, slabs, substructure, expansion joints, bearings, and deck. Their soundness is discretely evaluated using a descending five-point scale with 5 being entirely sound with no apparent damage.

Table 1 Measuring results.

Year of bridge	The total of inspected bridges	Inspected bridges by condition	Inspected bridges by length	Inspected bridges by material	Inspected bridges by span	Inspected bridges by structure	Inspected bridges by road	Inspected bridges by river	Inspected bridges by sea	Inspected bridges by other	Inspected bridges by other	Inspected bridges by other	Inspected bridges by other	Inspected bridges by other	Inspected bridges by other
1991	100	100	100	100	100	100	100	100	100	100	100	100	100	100	100
1992	100	100	100	100	100	100	100	100	100	100	100	100	100	100	100
1993	100	100	100	100	100	100	100	100	100	100	100	100	100	100	100
1994	100	100	100	100	100	100	100	100	100	100	100	100	100	100	100
1995	100	100	100	100	100	100	100	100	100	100	100	100	100	100	100
1996	100	100	100	100	100	100	100	100	100	100	100	100	100	100	100
1997	100	100	100	100	100	100	100	100	100	100	100	100	100	100	100
1998	100	100	100	100	100	100	100	100	100	100	100	100	100	100	100
1999	100	100	100	100	100	100	100	100	100	100	100	100	100	100	100
2000	100	100	100	100	100	100	100	100	100	100	100	100	100	100	100
2001	100	100	100	100	100	100	100	100	100	100	100	100	100	100	100
2002	100	100	100	100	100	100	100	100	100	100	100	100	100	100	100
2003	100	100	100	100	100	100	100	100	100	100	100	100	100	100	100
2004	100	100	100	100	100	100	100	100	100	100	100	100	100	100	100
2005	100	100	100	100	100	100	100	100	100	100	100	100	100	100	100
2006	100	100	100	100	100	100	100	100	100	100	100	100	100	100	100
2007	100	100	100	100	100	100	100	100	100	100	100	100	100	100	100
2008	100	100	100	100	100	100	100	100	100	100	100	100	100	100	100
2009	100	100	100	100	100	100	100	100	100	100	100	100	100	100	100
2010	100	100	100	100	100	100	100	100	100	100	100	100	100	100	100
2011	100	100	100	100	100	100	100	100	100	100	100	100	100	100	100
2012	100	100	100	100	100	100	100	100	100	100	100	100	100	100	100
2013	100	100	100	100	100	100	100	100	100	100	100	100	100	100	100
2014	100	100	100	100	100	100	100	100	100	100	100	100	100	100	100
2015	100	100	100	100	100	100	100	100	100	100	100	100	100	100	100
2016	100	100	100	100	100	100	100	100	100	100	100	100	100	100	100
2017	100	100	100	100	100	100	100	100	100	100	100	100	100	100	100
2018	100	100	100	100	100	100	100	100	100	100	100	100	100	100	100
2019	100	100	100	100	100	100	100	100	100	100	100	100	100	100	100
2020	100	100	100	100	100	100	100	100	100	100	100	100	100	100	100

## 2.2 Geographical Information System (GIS) data

We conducted an analysis utilizing GIS of the 2086 bridges managed Ishikawa Prefecture (out of 2314) for which location information is included. In actuality, each bridge has bridge length, the regular bridge inspection data only representative location information is included. The “representative location information” we refer to here corresponds the point at which the bridge was inspected, and does not necessarily correspond to the center point of the bridge. In this study, we used the representative location information as the representative point of each bridge. By displaying a bridge’s location information in GIS, we can add geographical information not included in the regular bridge inspection data. In this study, we used the National Land Numerical Information as our source of geographical information. The National Land Numerical Information represents numerical data pre-pared from information related to the national lands to support the promotion and formulation of land planning such as the Comprehensive National Development Plan, National Land Use Planning, and National Spatial Strategy [3].

## 3 Evaluation of the level of influence on the soundness of bridges

In this chapter, we will statistically analyze the bridges managed by Ishikawa Prefecture to determine what level of influence the environmental factors and bridge specifications (bridge length, years in service, superstructure material) on the soundness obtained during regular bridge inspections. As previously stated, Ishikawa Prefecture’s regular bridge inspections inspect six components: the main girders, slabs, substructure, expansion joints, bearings, and deck. However, our analysis targets what could be called the two primary components: the main girders, slabs.

### 3.1 Deterioration index from the soundness of bridges

In Ishikawa Prefecture’s regular bridge inspections, the level of damage to bridges is evaluated as soundness using a five-level scale every five years,. Simply using the soundness of bridges



as an index of bridge deterioration causes several problems, including the following two. First, this makes it impossible to grasp the deterioration in relation to a structure's real (as opposed to nominal) age, as it only accounts for a bridge's state of damage at one point in time. Second, it makes it impossible to grasp how soundness has recovered after rehabilitation, etc. In Ishikawa Prefecture, data on the regular bridge inspections began being accumulated in 2003. As there are bridges for which two inspections have been performed, we will use the data from two inspection cycles to calculate each bridge's deterioration index. As shown in Formula (1), we defined the deterioration index as the difference between the soundness obtained in the first regular inspection and the soundness obtained in the second regular inspection divided by the time span between both inspections. By using deterioration rate into an index, we can treat deterioration rates larger than 0 as normal deterioration, a deterioration rate of 0 as being no deterioration, and deterioration rates of less than 0 as the possibility of previous rehabilitation or reinforcement. Therefore, even with Ishikawa Prefecture's regular bridge inspection data, which does not contain thorough records of rehabilitation history, we can grasp the real deterioration by excluding samples with a deterioration rate of less than 0 that may have been rehabilitated or reinforced.

$$v = \frac{s1 - s2}{t2 - t1} \quad (1)$$

Where:

- v – deterioration rate;
- s1 – soundness during first inspection;
- s2 – soundness during second inspection;
- t1 – year of first inspection;
- t2 – year of second inspection.

### 3.2 Analysis methods

We used Hayashi's Quantification Method Type I to analyze the level of the influence of environmental factors on the soundness of bridges. Hayashi's Quantification Method Type I is a method for investigating the relationship between the objective variable and explanatory variables, creating a relational expression, and shedding light on the degree of influence each level of the explanatory variables has on the objective variables, the importance of the explanatory variables, and the predictions of the objective variable. The way it differs from multiple regression analysis is the data format for the explanatory variable. Multiple regression analysis uses quantitative data, while category data is used in the case of Hayashi's Quantification Method Type I. In this study, we have applied Hayashi's Quantification Method Type I by quantifying the levels of each environmental factor as explanatory variables. Further, in order to compare the level of influence that environmental factors and bridge specifications (bridge length, years in service, superstructure material) have, we decided to quantify the bridge specifications (bridge length, years in service, superstructure material) with each level and add them to the explanatory variables.

### 3.3 Dividing each factor into levels

When conducting our analysis, we divided each factor into several levels. Levels refers to the respective conditions set within each factor. Ideally, these conditions should be set based on standards established to serve as the basis of each environmental factor. However, there are currently no standards to serve as the basis for establishing levels for each environmental factor. Further, determining levels based on nationwide standard values would cause a bias in the sample sizes of the levels for environmental factors more prominent in Ishikawa Prefecture than in the rest of the country. As such, we decided to not set each environmental

factor subjectively, and to instead classify each environmental factor into five levels so the sample size of each level would be equal. However, because the data on the dispersal of antifreezing agents only indicates whether or not antifreezing agents had been dispersed, we decided to use two levels: Dispersal and No Dispersal. Further, we established levels for distance from the coastline and daily traffic volume and large vehicle traffic volume based on the standards devised by the authors. For bridge length, we established five levels: 0-5 m, 5-15 m, 15-50 m, 50-100 m, and >100m. For years in service, we established six levels: 0-10 years, 10-20 years, 20-30 years, 30-40 years, 40-50 years, and >50 years. For superstructure material, we established four categories: PC, RC, Steel, and Other.

### 3.4 Results of analysis

We used the deterioration rate calculated from the soundness of each component as the objective variable, and the environmental factors and bridge specifications as the explanatory variable. Further, in regards to the factors with large ranges obtained through Hayashi's Quantification Method Type I, in other words, the environmental factors that had a large influence on deterioration rate, we shed light on the positive and negative influences that affect the deterioration rate.

#### 3.4.1 Main girder deterioration rate

The sample size we used in our analysis of factors that influence the deterioration rate of main girders was 964 bridges. The multiple correlation coefficient was 0.33. Figure 2 shows the level of influence each factor had on the deterioration rate of main girders. In it you can see that the factor with the largest influence on the deterioration rate of main girders was superstructure material. It can also be said that the distance from the coastline was a very close second. The category scores for superstructure material and distance from the coastline are shown.

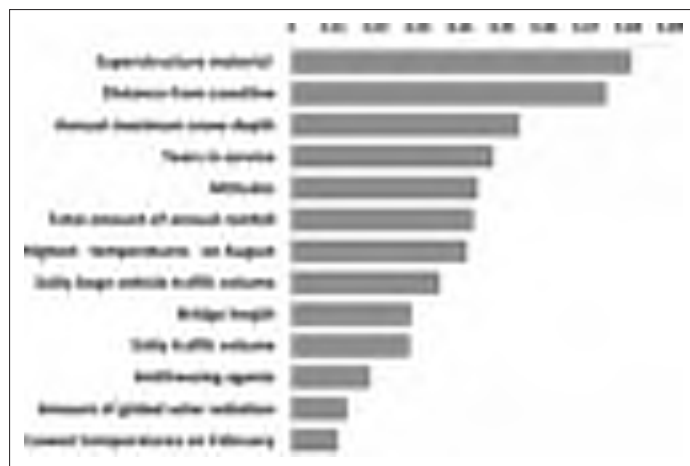


Figure 2 Range of each factor (main girders)

Figure 3 shows the category scores for superstructure material and distance from the coastline. In it we can see that the Steel and PC categories have a positive influence on the deterioration rate of main girders. In other words, they accelerate deterioration. Possible causes for steel bridges are that they may be more easily subjected to damage, or that the damage is more easily noticed. Possible causes for PC bridges include mistaken judgment by inspectors due to the fact that PC materials are intended to tolerate cracking. Excluding distances

of 300 m or less, we can see that the deterioration rate grows smaller the greater the distance from the coastline becomes. However, despite the fact that bridges within 300 m of the coastline are the most easily influenced by flying salt, the influence is negative. One possible cause is that measures against salt damage have already been implemented in terms of hardware and/or software for bridges within 300 m of the coastline.

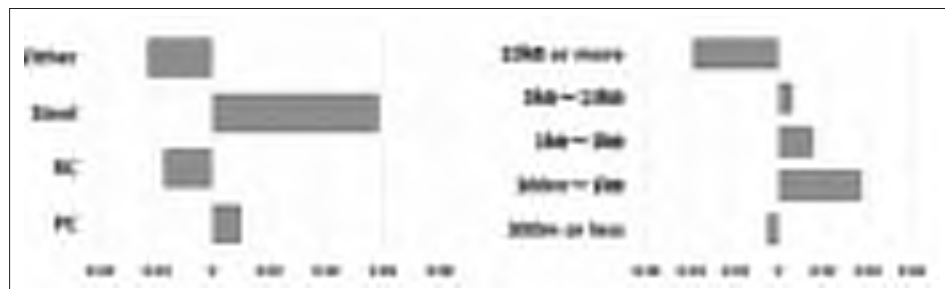


Figure 3 Category scores for superstructure material and distance from the coastline (main girders)

### 3.4.2 Slab deterioration rate

The sample size we used in our analysis of factors that influence the deterioration rate of slabs was 936 bridges. The multiple correlation coefficient was 0.33. Figure 4 shows the level of influence each factor had on the deterioration rate of slabs. In it you can see that the factor with the largest influence on the deterioration rate of slabs was years in service, and that the second largest influence was that of daily traffic volume. The category scores of the largest influences, years in service and daily traffic volume, are shown. Figure 5 shows the category scores for years in service and daily traffic volume. Longer years in service have the effect of accelerating the deterioration rate of slabs. This influence becomes positive at around 40 years in service. Therefore, the slabs of bridges with more than 40 years in service require countermeasures of some sort. In it we can see that, largely speaking, the larger the daily traffic volume becomes, the more the deterioration rate of slabs is accelerated. As the influence becomes positive when daily traffic volume reaches 4000 vehicles/day, the slabs of bridges with a daily traffic volume of more than 4000 vehicles/day require countermeasures of some sort.

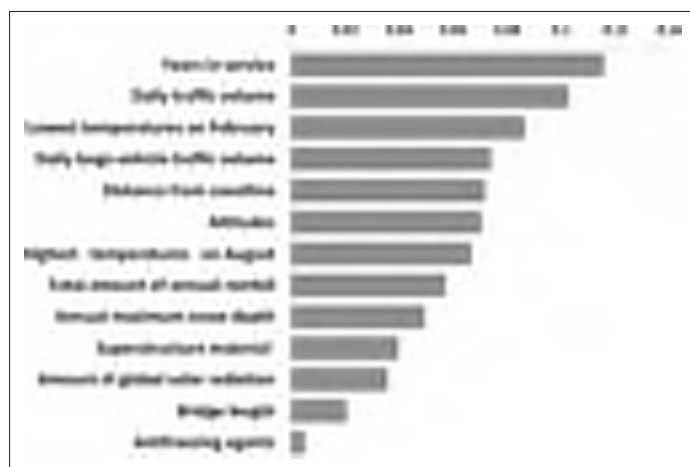


Figure 4 Range of each factor (slabs)

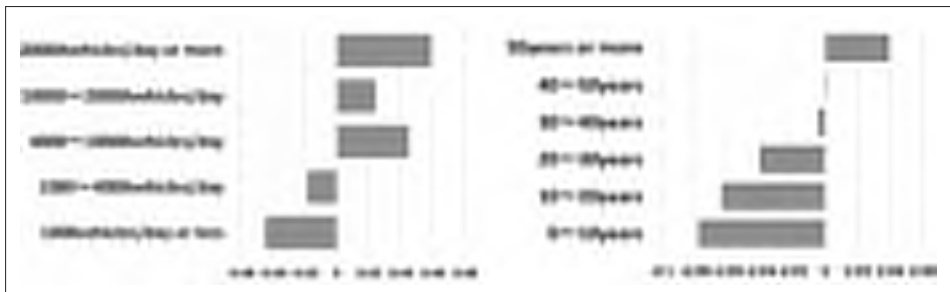


Figure 5 Category scores for years in service and daily traffic volume (slab)

## 4 Conclusions

In this study, using data from regular bridge inspections conducted as part of the maintenance and operation of road structures, and focusing on the environmental conditions that surround bridges, we analyzed the factors that influence the soundness of bridges obtained during inspections. Calculating an index called deterioration rate using inspection data from two inspection cycles, bridge inspections, we statistically analyzed the level of the influence that factors have on the deterioration rates of bridges using Hayashi’s Quantification Method Type I. As it became clear that while bridge specifications (superstructure material, bridge length, year of construction) had a large influence on the deterioration rate of each component, environmental factors also had an influence of equivalent size. As such, there is a need to consider environmental factors when determining the rehabilitation priority of bridges.

Considering the fact that this study focused only on bridges managed by Ishikawa Prefecture, and that there is insufficient basis for setting the levels for each environmental factor in regards to the deterioration of bridges, we are presented with a few issues for the future. The first is conducting a comparison with the bridges of other prefectures with different environments. The second is determining appropriate levels by establishing a number of level patterns in regards to the levels of each environmental factor. The final issue is utilizing the results of this study to propose methods for predicting deterioration and determining rehabilitation priority that take the factors that influence deterioration rates into account.

## References

- [1] MLIT White Paper 2014 Section2, Paragraph2 <http://www.mlit.go.jp/hakusyo/mlit/h26/hakusho/h27/pdf/np202000.pdf> Accessed 2015.7.17
- [2] MLIT The State of Deterioration and Challenges Regarding Deterioration Countermeasures <http://www.mlit.go.jp/road/sisaku/yobohozen/torikumi.pdf> Accessed 2015.7.17
- [3] National Land Numerical Information download service <http://nlftp.mlit.go.jp/ksj/other/details.html> Accessed 2015.7.17





## RECONSTRUCTION OF THE RAILWAY TUNNELS TIČEVO, KLOŠTAR AND RESNJAK

**Snježana Špehar**

*HŽ Infrastruktura, Zagreb, Croatia*

### Abstract

The reconstruction of the railway tunnels Tičevo, Kloštar and Resnjak was carried out as a part of the reconstruction and modernization of the RH2 corridor railway line M202 Zagreb Main Railway Station – Rijeka. Reconstruction of the railway tunnels Tičevo, Kloštar and Resnjak, each of which is characteristic in its own right, entailed the reconstruction of the tunnels, tunnel portals, approach cuttings at the tunnel entrance and exit, by installation of the state-of-the-art materials, using the specific technology of execution of works, and respecting the defined railway line closures to ensure railway transport safety, and reconstruction of the civil-engineering, power-electric, control-command and signaling and interlocking subsystems as a single unit.

*Keywords: reconstruction of the railway tunnels Tičevo, Kloštar and Resnjak*

### 1 Introduction

Railway corridor RH2 stretches from the state border with Hungary through Botovo – Koprivnica – Dugo Selo – Karlovac – Rijeka – Šapjane and ends at the state border with Slovenia. Railway line M202 Zagreb Main Railway Station – Rijeka is one of the railway lines which are situated on that Corridor alignment. Because of the detected instabilities in the approach cuttings (the geo-technical structure in front of the entrance portal) and exit cuttings (geo-technical structure after the exit portals), and in the tunnels, such as the rockslide of the stone blocks, raised shotcrete on the rings in the tunnels, appearance of stalactites in the winter period on the contact wire and track, which jeopardized the safety of the railway transport, people and material goods, it was necessary to start the reconstruction works, which, in addition to the works of track reconstruction, contributed to improvement of the technical conditions of the civil-engineering infrastructure subsystem.

### 2 The initial condition and reconstruction requirements

During maintenance of the tunnel, the instabilities on the approach and exit cuttings of the tunnel were detected, reflected in of falling out of stone blocks of various sizes due to deterioration of the rock mass; rockfalls due to flushing of soil and loss of retaining capacity; sliding i.e. uncontrolled slipping of the material onto the railway line, while in the tunnel in the winter period the appearance of stalactites on the contact wire and the track in the structure gauge of the rolling stock were detected, causing disturbances on the overhead line equipment and the danger of breaking, but also the danger of the train damage and derailing.

The reconstruction was aimed at providing safety of the railway transport, people and material goods by providing permanent stability of the approach cuttings, exit cuttings and tunnels, in order to ensure the conditions in which the key properties of the structure are provided,

which in turn would enable performance of the regular maintenance cycles without major financial spending.

In selection of the solution of reconstruction it was necessary to take into consideration the height of the overhead line equipment and its minimum distance from the tunnel vault, meeting of conditions of the GB structure gauge, and in the approach and exit cuttings, for the sake of integration into the natural surroundings and preservation of the original configuration, the technical solution should be such to let it blend into the natural surrounding and retain its authentic configuration and appearance, and at the same time to be in line with the technology of works on the railway lines (carrying out of works at a fast pace within a short period). All railway tunnels are constructed without hydro-insulation which protects from penetration of water, and the rings of dressed stones are at the same time their primary and secondary lining. Tunnel Tičevo, 173 m long, was constructed in 1872 for two tracks. It is situated between the stations Ogulinski Hreljin and Gomirje and consists of 19 tunnel liners, rings of dressed stones with the interspace of the live rock, and the overburden of ca. 10 m, on which here and there is shotcrete. The entrance portal has already been reconstructed with shotcrete and exit portals are situated in the live rock. The approach cutting and exit cutting are also in the live rock.



Figure 1 Entrance portal of tunnel Tičevo and the exit cutting

Tunnel Kloštar, 248,40 m long is situated between stations Gomirje – Vrbovsko. It was constructed in 1872 in the limestone rock with the overburden of ca. 7 m. It has five tunnel liners, i.e. rings of dressed stones with the interspace of the non-lined rock. Its width accommodates two tracks. On all five rings there is shotcrete of questionable stability. The entry and exit portals are of the live rock above which there is the earth mass underpinned by the mass of the trees. The approach and exit cutting are in the live rock.



Figure 2 Entrance portal of tunnel Kloštar and tunnel's interior

Tunnel Resnjak, 197,72 m long, is situated between the stations Zalesina and Delnice. The tunnel was constructed in 1873 for one track of the GB structure gauge (basic). It consists of seven niches which are situated at every 25 m. It is clad with the dressed stones in 34 tunnel liners, and here and there, there is shotcrete. The entrance portals, frontal walls and the wing walls in the approach cutting and exit cutting are also made of dressed stones, above which there is very unstable soil with tendency of sliding and rockslides. From the last niche before the exit portal, the material has been falling onto the track; therefore for safety reasons the slow running of trains of 20 km/h is introduced in the tunnel.



**Figure 3** Entrance portal of the tunnel Resnjak, interior of the tunnel and the niche from which the material is falling

### 3 Project documentation

Based on the Contract for the service of external consultant for special inspections of the track structures, the Main civil-engineering design of reconstruction of the tunnels and approach cuttings between the consortium of bidders, IGH d.d., ŽPD d.d. Geotehnički studij d.o.o., and the customer, HŽ Infrastruktura LLC, the following project documentation was prepared:

- 1) Project of reconstruction of tunnel Tičevo, the main and the detailed civil-engineering design of reconstruction, project reference 23-001/13, Institut IGH d.d., May 2013.
- 2) Project of reconstruction of the cutting approaches of tunnel Tičevo, the main and the detailed civil-engineering design of reconstruction, project reference 23-001/13, Geotehnički studio d.o.o., May 2013.
- 3) The geodetic survey of tunnel Tičevo, project reference 23-001/13, ŽPD d.o.o., 2013.
- 4) Project of reconstruction of tunnel Kloštar; the main and the detailed civil-engineering design of reconstruction, project reference 23-002/13, Institut IGH d.d., July 2013.
- 5) Project of reconstruction of the tunnel cutting approaches of tunnel Kloštar, the main and the detailed civil-engineering design of reconstruction, project reference 23-002/13, Geotehnički studio d.o.o., June 2013.
- 6) Geo-technical survey of instability of the cutting approaches of the tunnel Kloštar, project reference 23-002/13, Geotehnički studio d.o.o., June 2013.
- 7) Geodetic survey of the tunnel Kloštar, project reference 23-002/13, ŽPD d.o.o., 2013.
- 8) Project of reconstruction of tunnel Resnjak, the main and the detailed civil-engineering design of reconstruction, project reference 23-003/13, Institut IGH d.d., July 2013.
- 9) Project of reconstruction of the tunnel cutting approaches of tunnel Resnjak, the main and the detailed civil-engineering design of reconstruction, project reference 23-003/13, Institut IGH d.d., November 2013
- 10) Geo-technical survey of instabilities of the tunnel cutting approaches of the tunnel Resnjak, registration number 4110-36/13, Institut IGH d.d., July 2013.



## 4 Reconstruction works

Works of reconstruction in all three tunnels are performed in phases according to the approved railway line closures (on weekdays an 8-hour closure; on weekends the 36 and 72 hour- non stop- closure), with switching off of the contact wire and with earthing with the protection rod outside the boundary of the works operations on both sides of the tunnel cutting approaches and cutting exits. Protection of the track and of the signalling and interlocking lines of the power electric infrastructure subsystems was carried out using geo-textile, civil-engineering nylon, board formwork, while the optic cable was inserted into the plastic tube and buried into ground, and after completion of works it was returned to the girders in the tunnels.

Reconstruction in all three tunnels consisted in removal of the existing shotcrete, washing and cleaning of the surfaces to be reconstructed, of contact injecting (injecting of the grooves between the dressed stones) and binding injecting (injecting of the space of the dressed stone and the ground behind in order to statically reinforce the dressed stones) by the cement injection mixture with addition of bentonite and superplasticizer; installation of 0.7 to 1,0 m long soakways of 7 cm in diameter, installation of the steel welded net Q-188 and sprayed mortar R4, 3 to 10 cm thick, depending on the condition of meeting the structure gauge GB; installation of the bar and cable anchors 500/550 N/mm<sup>2</sup>, 1,5 cm to 3,0 cm in diameter, 1 to 3 m long, at the distance of 2,5 m to 4 m; and application of the permanent elastic poly-cement coating in three layers, ca 0,15 cm thick each with the net where the flatness of the base allows. Tunnel cutting approaches and exits, due to their specific qualities in providing stability, were constructed by the system of anchors and various pre-stressed protection nets, depending on the conditions on the site, structure and characteristics of the soil, type and character of the load.

In tunnel Tičevo reconstruction works are divided into three groups: reconstruction of the unstable zones of the stone lining, reconstruction of the unstable zones of the stone lining and reconstruction of the rock mass. The reconstruction of the unstable zones of the stone lining comprised the stretches in the tunnel vault of the stone blocks “wedged” by the small wooden wedges which protected the stone blocks from the loss of stability, and the reconstruction of the site where stone blocks started protruding towards the tunnel gauge. After the machine and manual removal of the shotcrete from the surfaces where it was placed, the surface was washed and cleaned. Since the dressed stones in the vault visually pointed to the questionable stability, the next step was installation of the steel fabric and application of the sprayed mortar, so that the outlines of the steel fabric were visible, and that the dressed stones could bind and harden. The contact and binding injection was followed by the drilling of the holes and installation of the adhesion bar anchors, their injection, fastening and application of the 5 cm thick sprayed mortar. Into the tunnel flanks at the top of the tunnel wall, the soakways were installed, and where it proved necessary to channel the line in order to reduce the seeping of water and pressure on the tunnel lining, the number of the installed soakways was increased. The last phase was application of the permanent elastic poly-cement coating in three layers which, due to rugged base, was applied without net. The caverns in the tunnel were reconstructed by the steel fabric and sprayed mortar. The zones of the entrance and exit portals were protected by the steel fabric, sprayed mortar and soakways.

The cutting approach and exit of the tunnel were reconstructed by manual and machine removal of the unstable stone blocks. The stability of the cutting approaches and exits was provided by the system of the hexagonal, double-twisted protection nets Pr 400/550 MPa by the fixed bar anchors, system of the bar anchors and protective pre-stressed retaining net type TECCO of high tensile strength of 1770 N/mm<sup>2</sup>. On both sides of the cutting approach and exit, in the entire length because to the cable of the signalling and interlocking electric power infrastructure subsystem, and the proximity of the foundation of the contact wire and the cutting exit, instead of the concrete channels type II, the drainage pipes are installed.



**Figure 4** Reconstructed vault of the tunnel Tičevo and cutting exit of the tunnel

Reconstruction of tunnel Kloštar was carried out in two ways: by reconstruction of the rings of the dressed stones and reconstruction of the rock mass. From the dressed stones first the old shotcrete was removed manually and by hydro-demolition. When the works began, one part of the shotcrete fell off by itself. After removal of shotcrete, the washing was carried out, as well as the contact and binding injection along the entire length of the ring from the foot to the crown. At the frontlines of the rings the steel fabric and sprayed mortar were installed, and as the final phase, the permanent elastic coating in three layers, with the net, was applied. After cleaning and washing, in the rock mass the micro-cracks were detected, from which the seeping of water onto the track was visible. In line with the project supervision, due to large-scale roughness in the tunnel vault, instead of sprayed mortar, the sprayed concrete with fibres was installed, so that the steel fabric could be installed, to be protected by the sprayed mortar in the following phase. Water which was seeping from the vault was channeled by the small pipes before installation of the steel fabric into the flanks of the tunnel by the rock wall. The permanent elastic coating in three layers without net was the last phase of the works on the rock. During execution of works, after injection of the second ring, in the period of heavy rainfalls, through the soakways of the second ring, a large quantity of water seeped along the front of the track wooden sleepers, so the channels which were installed to channel the water towards the channels in the cutting approach. The entrance and exit portals were protected by the protective pre-stressed net type TECCO G65/3 of high tensile hardness of 1770 N/mm<sup>2</sup> and by the system of the bar and cable anchors. The caverns at the entrance and exit portal where reconstructed by channeling the water through the drainage into the corners of the portals outside the structure gauge zone, and the cracks were filled by the sprayed concrete.



**Figure 5** Cutting approach and entrance portal of the tunnel Kloštar and the rings at the exit part of the tunnel after reconstruction

Reconstruction of the cutting approaches and exits was carried out by the manual and machine cleaning of the slopes, installation of the pre-stressed protection net DELTAX of

high tensile hardness of 1770 N/mm<sup>2</sup> which was fixed by the system of anchors. On the left side of the cutting approach and exit, the channels type II were installed, which channel the accumulated water.

Reconstruction of the tunnel Resnjak due to the critical structure gauge also differed in the reconstruction of the last niche before the exit portal from which the material was uncontrollably slipping onto the track. The first activity in execution of the reconstruction works was to identify places where the shotcrete of weak adhesion capacity, deteriorated and broken, and to remove it. In order to carry this out, the entire tunnel was “knocked” mechanically by the hammer (the adhesion capacity was checked by the hammer, and the sound provided the information of the adhesion of the shotcrete onto the base). Removal of the shotcrete was carried out in some places, manually and with machines along the entire tunnel. Those places for which it was found to have good adhesion, the pull-off method was made, which confirmed it. After washing and cleaning, the holes for the bar anchors were drilled into the broken parts of the stone blocks, the anchors were installed and injected. Sporadic injecting was carried out in the tunnel vault, and binding injection in the tunnel wall, followed by installation of the steel fabric and 3 cm thick sprayed mortar. During works of shotcrete removal in the tunnel vault, several yellow plastic half-pipes were found, which were channeling water into the flanks, and they were situated under the shotcrete. Since during the summer time period a large quantity of water was seeping onto the track, twelve half-pipes were installed in the tunnel, some of which were visible, and some where protected by the sprayed mortar, since the structure gauge allowed that. The last phase of works was application of the permanent elastic coating. Reconstruction of the last niche before the exit portal of the tunnel entailed the removal of the unbound parts of the rock mass, construction of the reinforced concrete pillow with the armature, drilling of the anchors and injecting above the niche vault. In the niche the soakways were drilled, the niche was clad and protected by the sprayed mortar and permanent coating. All other niches in the tunnel were reconstructed by washing, cleaning, underpinned and protected by the sprayed mortar and permanent elastic coating. After completion of works, the marks of the niches in the tunnel were outlined too.



**Figure 6** Cutting exit of tunnel Resnjak and interior of the tunnel after reconstruction

Reconstruction of the cutting approaches and exit cuttings of the tunnel was carried out by construction of the anchors, hexagonal double-twisted net of the cords and before their installations the drains were drilled and the dressed stones were bound by injection including the leveling of the grooves. Above the entrance and exit portal the barrier of posts, net and steel cords was constructed. The posts are constructed of the steel profiles NPI-20 and NPI-16, anchored into the concrete foundations at the distance of 3 m. The net of the barrier is hexagonal, double-twisted and galvanized. On the left and right side of the cutting exit and above the entrance portal, the concrete channels with descent were installed.

## 5 Conclusion

Reconstruction of the tunnels Tičevo, Kloštar and Resnjak, each of which is specific in its own right, using the state-of-the-art materials of similar properties and specific technology, within a short period of time provided the permanent stability of the cutting approaches, cutting exits and tunnels, providing essential qualities to the structure, which contributed to the safety of the railway system, people, material goods, and partial reconstruction and modernization of one of the segments of the RH2 corridor.

## References

- [1] Institut IGH d.d.: Design of reconstruction of tunnel Tičevo, the Main and detailed design of reconstruction, project reference 23-001/13, May 2013.
- [2] Geotehnički studio d.o.o.: Design of reconstruction of the cutting approaches of the tunnel Tičevo, the Main and detailed design of reconstruction, project reference 23-001/13, May 2013.
- [3] Institut IGH d.d.: Design of reconstruction of the tunnel Kloštar, the Main and detailed design of reconstruction, project reference 23-002/13, July 2013.
- [4] Geotehnički studio d.o.o.: Design of reconstruction of the tunnel cutting approaches of tunnel Kloštar, the Main and detailed design of reconstruction, project reference 23-002/13, June 2013.
- [5] Geotehnički studio d.o.o.: Geo-technical survey of instability of the cutting approaches of tunnel Kloštar, project reference 23-002/13, June 2013.
- [6] Design of reconstruction of tunnel Resnjak, the Main and detailed design of reconstruction, project reference 23-003/13, Institut IGH d.d., July 2013.
- [7] Institut IGH d.d.: Design of reconstruction of the tunnel cutting approaches of tunnel Resnjak, the Main and detailed design of reconstruction, project reference 23-003/13, November 2013.
- [8] Institut IGH d.d.: Geo-technical survey of instability of the cutting approaches of tunnel Resnjak, registration number 4110-36/13, July 2013.



## 7 INTEGRATED TIMETABLES ON RAILWAYS





## CHALLENGES FOR AN INTEGRATED TIMETABLE IN AUSTRIA

Hans Wehr<sup>1</sup>, Andreas Schöbel<sup>2</sup>

<sup>1</sup> Senior expert in Railway Engineering, Austria

<sup>2</sup> OpenTrack Railway Technology Ltd., Austria

### Abstract

This paper describes the challenges for implementation of an integrated timetable in the network of Austrian Railways. One strategic aim of transport policy in Austria is the realisation of an integrated timetable in the railway section. Hence, some adoptions of the existing network are necessary for achieving suitable running times between the timetable nodes of the network. Some challenges to be solved in order to reach the aim of a real integrated timetable by the year 2025, will be discussed in this paper. Of course, there are many activities focused on certain lines; however, on some lines activities needed for reaching the 2025 goal are still missing. For this reason, sections of the network of Austrian Railways where activities have to start immediately to provide sufficient service will be identified.

*Keywords: integrated timetable, railway infrastructure design, railway project management, strategic railway planning*

### 1 Introduction

In many European countries, integrated timetables for passenger traffic have been successfully introduced in the last years. The success in passenger transport can be explained by simplified timetables. Moreover, this ensures passengers that there will be a connection to any destination they are interested in. For the design of an integrated timetable it is necessary to define nodes in the network of a railway infrastructure where the frequency of passengers is high. Typically, these nodes can be found in larger cities; however, this is not always the case. Nodes in the railway network are also points where passengers want to change between different directions. Typical infrastructure design of such nodes is shown in Figure 1. Some minutes before the full hour trains from all directions are entering the node. A certain time slot is reserved for passenger exchange between trains. Finally, after some minutes all trains leave the node in all available directions. Hence, such nodes have to offer a capacity of at least so many tracks as trains want to enter. Of course, there is the opportunity to share station tracks for even two trains if they just enter the station and then turn back into the direction where they were coming from. As it can be seen in Figure 1, for example, four tracks are required for four trains wanting to enter the node. If they do not pass through the station, but they will turn back after the passenger exchange, two tracks would be also enough for realisation of an integrated timetable. If it is required to respect the arrival times, the sections before the node have to be double track sections. Otherwise, a short headway time on the entry sections might be enough to cover the boundary conditions.



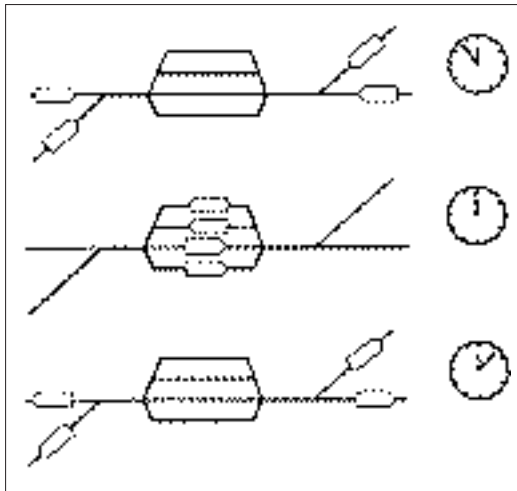


Figure 1 Basic principle of an integrated timetable

## 2 Realisation in Austria

### 2.1 Strategic Masterplan for Transport

Based upon the strategic Masterplan for Transport in Austria, the Infra Manager ÖBB Infrastruktur AG developed their target net for the year 2025. To achieve this target net, several construction measures (upgrading of existing lines, building of new lines) have been defined and considered in the budget planning.

### 2.2 Approach of two overlaying services

Due to the large investment into high speed lines in Austria during the last decades, the upgraded and new constructed lines offer the opportunity to provide a high speed and a conventional service in long distance relations, e.g. Vienna – Salzburg, Vienna – Graz – Klagenfurt. Both services can be synchronised only in selected nodes. To compensate for this shortcoming, the density of service can be increased by offering constant connections between the high speed and the conventional service. In Austria, the high speed service is provided by so called RailJet train sets. Conventional service in this context means the traditional InterCity train.

### 2.3 Ongoing projects to realize an integrated timetable till 2025

Travel times can be divided into three categories: first, they fit into the system of an integrated timetable (white). Second, travel times do not fit into the system, although activities are carried out (yellow). Third, travel times do not fit and no related activities are even planned or the implementation of those will be too late (red). Figure 3 shows the situation in the target net for the year 2025, when all ongoing measures for travel times across Austria will be finished. Since the investment strategy is well known, non fitting travel times can be either prolonged or shortened. Whereas shortening of travel times needs inevitably further investments, prolonging can be seen as the compromise, when there is no budget for related measures. Interesting is the third category; there are no activities foreseen, although those sections are quite important for passenger traffic in Austria.



Figure 2 Services, nodes and links in the Austrian network



Figure 3 Edge time across Austria in the target network

## 2.4 Harmonisation of edges

By 2025, the new line from Vienna via Graz to Klagenfurt will be in operation; however, there will not be a reduction of running time between Bruck/Mur and Graz, although here an edge time of 30 minutes would be required. Alternatively, it can be extended up to 45 minutes and, additionally, it must be shortened between Wiener Neustadt – Graz and Graz – Klagenfurt, in order for an integrated timetable to be achieved, without extension of the overall travel time on this line. (see Figure 4). Due to the opening of two new tunnels, namely Semmering and Koralm, edge times of 45 minutes for each of them are possible for the RailJet service. Trains running from Graz in directions to Linz/Salzburg/Innsbruck shall go via Leoben, the same as today, to allow for the system to conform edge times.



Figure 4 Harmonised edge times across Austria in the target net

## 2.5 Required infrastructure measures

After opening the new central station in Vienna, the starting point for timetable construction has been shifted from Salzburg to Vienna (symmetry at minute 00 and/or 30). Between Wien Hbf and Wien Meidling, there are independent routes for the west-east and north-south-traffic. To allow the application of this concept the north-south-traffic has to be moved from the existing southern line towards the so called ‘Pottendorfer line’, between Wien Meidling and Wiener Neustadt. The upgrade of the ‘Pottendorfer line’ is still going on. In Salzburg, arrival and departure times between the two services do not match since the timetable has been changed. The shortening of edge time between Linz and Salzburg down to 60 minutes for the RailJet service and down to 45 minutes between AttnangPuchheim and Salzburg for the InterCity service are urgently required, Figures 5 and 6. Otherwise, there is no integrated system at Salzburg available, which will lead to a huge change overtime, of up to 20 minutes. Additionally, it would be necessary to continue with the extension of the western line from Vienna to Salzburg, especially in the area of Salzburg, due to missing capacity for local trains. This extension will not be available by 2025, since planning has just recently started. Another aspect is related to the density of services in the western part of Austria. If interval is shortened to 60 minutes, train crossings will take place more frequently on the single track sections across Arlberg (line from Innsbruck to Feldkirch). For nodes the possibility of parallel entering and leaving of trains has to be checked.



Figure 5 Edge travel times for the RailJet services



Figure 6 Edge travel times for the InterCity services

### 3 Conclusions

Although it is one of the major strategic aims of Austrians public transport policy, the implementation of a consistent integrated timetable by the year 2025 is not ensured. This paper has clearly shown which sections in the network of Austria need additional actions to be taken immediately for the strategic aim to be reached.

### References

- [1] Pachl, J.: Systemtechnik des Schienenverkehrs, Vieweg+Teubner Verlag, 2011, ISBN 978-3-8348-1428-9.
- [2] Uttenthaler, H.: Grundlagen eines auf einem Integrierten Taktfahrplan basierenden Eisenbahninfrastrukturausbaues am Beispiel Zentraleuropa, Diplomarbeit Technische Universität Graz, Institut für Eisenbahnwesen und Verkehrswirtschaft, 2010.





## SOLVING A BOTTLENECK ON A STRATEGIC POINT OF THE HUNGARIAN RAILWAY NETWORK

Viktor Borza<sup>1</sup>, János Földiák<sup>2</sup>

<sup>1</sup> VPE Rail Capacity Allocation Office, Hungary

<sup>2</sup> MÁV-START Co., Hungary

### Abstract

This paper is about solving a railway infrastructure bottleneck around Budapest, which currently slows down cargo trains the most. The solution includes a direct passenger link via Budapest Airport and a short high speed line, which would decrease the travel times of long distance trains, and which allows to increase the frequencies of Budapest suburban trains. All the new services are planned by fitting to the integrated periodic timetable based infrastructure development strategy. The new infrastructure parts are at the beginning of the planning phase. The first part is about the capacity of the current railway network and about demands of freight transportation. It analyses the demands, and points out the bottlenecks of the network, i.e. where the capacity is not enough. It locates the bottleneck which is responsible for decreasing the circulation speed of cargo trains the most. The second part is about passenger transportation demands in the region of Budapest. The current problems are: poor transportation links to Budapest airport; poor usage of railway lines for urban transportation; impossibility of making more frequent train services on suburban lines. It defines the lacks of railway infrastructure, which make it impossible to fulfil those demands. The third part describes the previously planned solutions for the presented problems, then points out why those solutions were not efficient enough. Taking into account the lessons learned, the most efficient solution will be shown in the last part. This solution is capable of solving all the previously described problems. It contains a third track between Kelenföld and Ferencváros stations (crossing the Danube in Budapest); two new stations in important hubs in the south of Budapest (Közvágóhíd, Népliget); and a new partially high speed line between Budapest and Monor, connecting the terminals of Budapest airport. These solutions are planned by using integrated periodic timetables.

*Keywords: ITF, railway infrastructure development, freight trains, rail capacity, suburban railway, urban railway*

## 1 Freight transportation directions through Hungary

### 1.1 Regional trade

26% of Hungarian export goes to Germany, the second largest export partner is Romania with 5.6%. The export to all neighbour countries is altogether 23%. The import from Germany is 25%. From all neighbour countries it is 19% (first 3 are Austria, Slovakia, and Romania with ¾ of 19%). That means that the majority of Hungarian trade is with Germany, Austria, Slovakia and Romania. These countries are reachable on the southeast–northwest corridor. [2, 3]

## 1.2 Continental trade

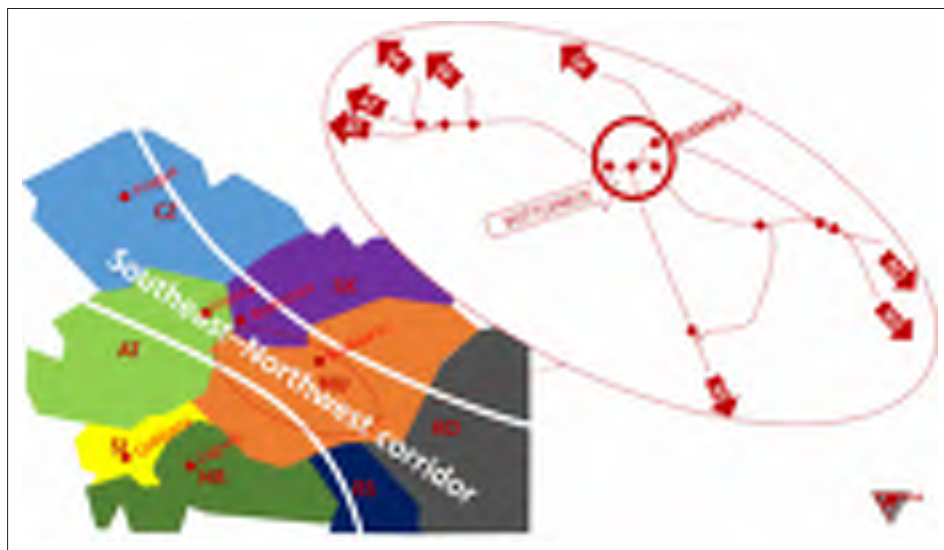
Most of the freight traffic in Europe is inside Europe's core area, the so called 'Blue Banana'. From all the other European regions, the majority of freight traffic goes to or comes from the Blue Banana region. From Hungary, the Blue Banana region is reachable via Northern Austria and Western Slovakia. Also Northern Italy is reachable via Austria, because of better infrastructure and services compared to the routes via Croatia and Slovenia. From the Balkans, the whole Blue Banana region is reachable as well on the southeast–northwest corridor of Hungary. [1] [2]

## 1.3 Intercontinental trade

At the moment there is no significant intercontinental traffic via Hungary. Asia–Europe freight traffic is mainly on sea, partially by airplanes. Only less than 1% is on rail, mostly on Trans-Siberian Railways, and via Belarus and Poland. If in the future the intercontinental traffic will increase, it can increase only on the southeast–northwest corridor through Hungary, because that makes a connection between the Silk Way, respectively the ports of Aegean Sea, and the Blue Banana region. The same route could be used by Mediterranean Africa–Europe traffic.

## 1.4 SE-NW railway link through Hungary, bottleneck

As all the international freight traffic goes on the southeast–northwest corridor through Hungary, and the Hungarian railway network is very Budapest-centric, all the international freight traffic has to go through Budapest (Figure 1). At the moment there is no unsolvable capacity problem of cargo trains, but on a bit higher traffic level Budapest could be a significant bottleneck. We can assume higher rail freight traffic, because of the expected economic development of this region.



**Figure 1** The vast majority of freight traffic through Hungary defines a southeast–northwest corridor. On that direction the bottleneck of the railway network can be found within Budapest



## 2 General timetable structure of Budapest suburban lines and special capacity stress of heterogeneous traffic

The main reason that a metro or a suburban line with homogeneous traffic can have a much higher frequency than railway lines with heterogeneous traffic, is the equal steepness of their time-distance graph (timetable path). On a line with homogeneous traffic there are only stopping-trains by unified trainsets (same accelerating capabilities). This means parallel paths which can achieve the maximal capacity utilization of a double track (direction separated) railway line.

On the main suburban lines of Budapest there are commuter trains, suburban semi-fast trains (mainly zoning trains), long distance trains (InterCity and fast trains) and freight trains. All of these train types have a timetable path with different steepness. That causes ineffective capacity utilization: less capacity. Integrated Periodic Timetable (ITF) with defined transfer nodes results in a standard pattern. The different steepness of the paths ensures half hourly periodic frequencies, which is not enough in city transport. Because the gaps are periodically closed between the stopping-trains and the fast trains, freight trains have to get out of the way of passenger trains several times. Therefore the lines with high frequency suburban and long distance services have a low capacity for cargo trains with slow timetable paths. [4]

### 2.1 Demands of the Budapest region

At the moment on the current railway infrastructure there are suburban services with thirty minute intervals. On the double track lines with heterogeneous traffic it is impossible to make more frequent services with stopping-trains. The demands of passenger transportation in the region of Budapest are to make suburban and urban services with fifteen minute intervals.

Airport linking: Budapest airport has poor transportation links to Budapest city. There is no railway link, no metro line; it is connected only by a bus line. The capacity of the bus line is too low and the travel time is too long. Budapest needs a faster and higher capacity link, from the city centre, and from northern and western districts of the city as well. As the Budapest airport is the only significant airport in the country, connections from the other cities of Hungary and from the whole region would be important.

## 3 Previously planned solutions: V0 and FEREX

### 3.1 V0, the cargo line

There was a not realised project constructing a brand new line only for cargo trains, via Komárom—Székesfehérvár—Kecskemét—Szolnok to avoid the Budapest bottleneck. But

- constructing a freight line avoiding Budapest is too expensive,
- many cargo trains cannot use it because of geographical reasons (e.g. Slovakia and Budapest are not on the planned line),
- many trains cannot avoid Budapest because of operational reasons,
- it cannot solve the suburban frequency problem, because it is caused by the fact that faster and slower passenger trains use the capacity of the tracks in an ineffective way

The project cannot be economically viable.

### 3.2 FEREX, the airport express

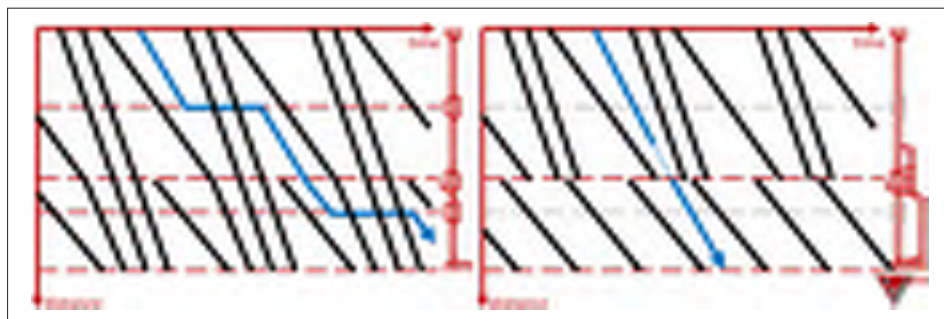
There was a cancelled project to connect Budapest city to Budapest airport, with an airport express train. The project proposed a new line in the airport area and a dedicated newly built third track from Budapest-Keleti via Kőbánya-Kispest to that area. Even though the passenger number of the airport is increases every year (2013: 8.5 million; 2014: 9.1 million; 2015: 10.3



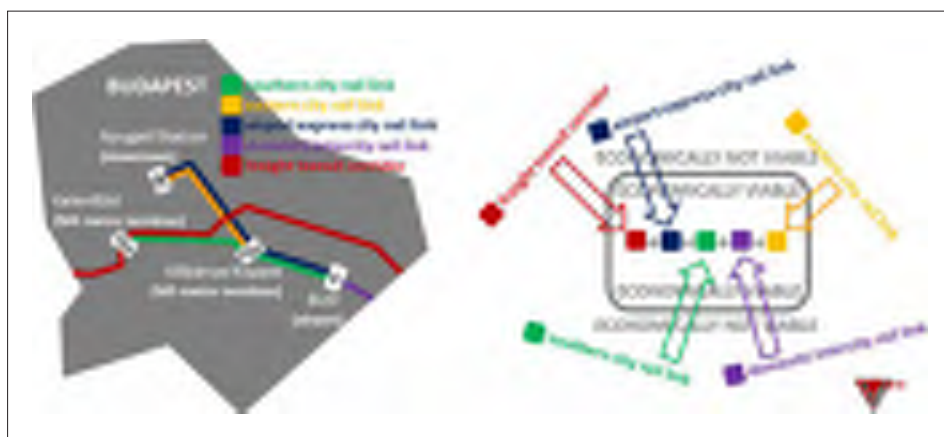
million), it is not enough to finance a point-to-point railway link. A dedicated railway link could be economically viable only with over 20 million passengers. The airport express would have made a connection only to the city, and it would not have been a solution for Eastern Hungary. Because there are not enough passengers, and because the point-to-point link would be very expensive, this project would never be economically viable.

#### 4 The smart solution

It seems logical to take away freight traffic to use its capacity for increasing suburban service, but as we will see (visualized on Fig-2. left side), it does not help in increasing suburban trains frequency. The capacity of the line is depending on the number of fast and slow paths. Effective solution: rising capacity utilization by homogenization of traffic (making paths as parallel as it is possible installing new tracks for faster trains at least on those line sections where the traffic is the heaviest). Taking away faster trains to use their capacity for increasing (sub)urban and freight traffic (visualized on Fig-2. right side). If we build new tracks for the faster trains, the stopping-trains and the cargo trains can use the old tracks, sharing capacity, because their speed is more similar, so their paths are more parallel to each other.



**Figure 2** On the left: typical timetable structure on major Budapest suburban lines. The blue path is the fastest possible freight path. On the right: increasing capacity by new tracks for faster trains in the inner zone. The blue path shows that the freight train is faster, even though the frequency of suburban trains is doubled



**Figure 3** Several needed infrastructure development projects are not economically viable alone but economically viable together

The ideal solution is to build different lines for fast trains (long distance and suburban fast trains as well), but we have to find a solution which solves the problem of the cargo traffic, which connects the airport to the city and which allows to increase suburban and urban train frequencies, because separated projects are not economically viable, Figure 3.

#### 4.1 Three in one solution

As we see a point-to-point airport express link and a separated cargo line wouldn't be economically viable, we propose to build a new thirty km long double track line for fast trains between Kőbánya-Kispest and the suburban train terminus Monor via Budapest Airport terminals. This solution would result in a cost-effective way of connecting Budapest airport to the city and to other parts of Hungary, and it would take away the fast trains from busy suburban lines, which link southwest suburbs to the city. Between Budapest and Szolnok there are two parallel lines (Budapest—Újszász—Szolnok line and Budapest—Cegléd—Szolnok line) with long distance and suburban traffic, Figure 4. The proposed new line would be connected only to the Budapest—Cegléd—Szolnok line, but it would create the possibility to run all the long distance services on that direction. As a result of this, the Budapest—Újszász—Szolnok line would remain only for the cargo and suburban trains, resulting in a much higher capacity for those segments.

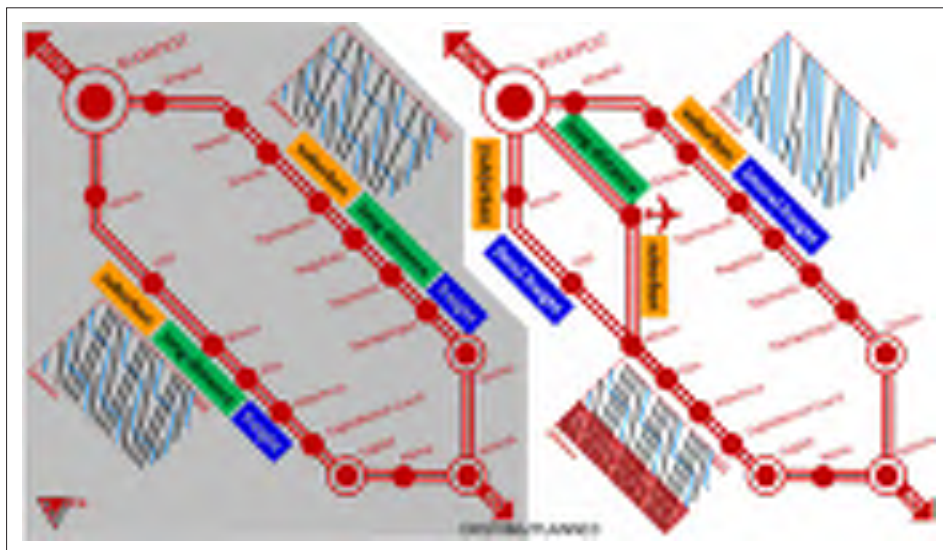


Figure 4 Mixed freight suburban long-distance services today, and separated functions after the proposed project

#### 4.2 Two in one solution

The narrowest bottleneck for cargo trains is the bridge over the Danube (section between Kelenföld and Ferencváros). For increasing the capacity of this section we propose a third track. The new three track line will be useable for more suburban and more freight services as well.

#### 4.3 Cost effective airport link

On the proposed new line four long distance trains, two suburban zoning trains from Budapest-Nyugati, and two suburban trains from Kelenföld (west hub of Budapest) would run. In

total there would be six trains per hour from Nyugati (every ten minutes). These trains would not be new services, these services are existing today as well, but in another line. They would connect the airport without increasing the operational costs. The two suburban services from Kelenföld are also running today, but only between Kelenföld and Kőbánya-Kispest. Those services would be extended to Budapest Airport.

#### 4.4 Increasing capacity for suburban trains

On the inner section of the old line between Kőbánya-Kispest and Monor all the fast trains would be removed, therefore it would be possible to create fifteen minutes frequencies in suburban services. Also on the parallel Budapest—Újszász—Szolnok line there wouldn't be any long distance trains anymore, so the suburban capacity could increase there as well. But because the suburban fast trains (zoning trains) cannot be removed, the fifteen minute interval would not be possible yet.

#### 4.5 Budapest freight corridor

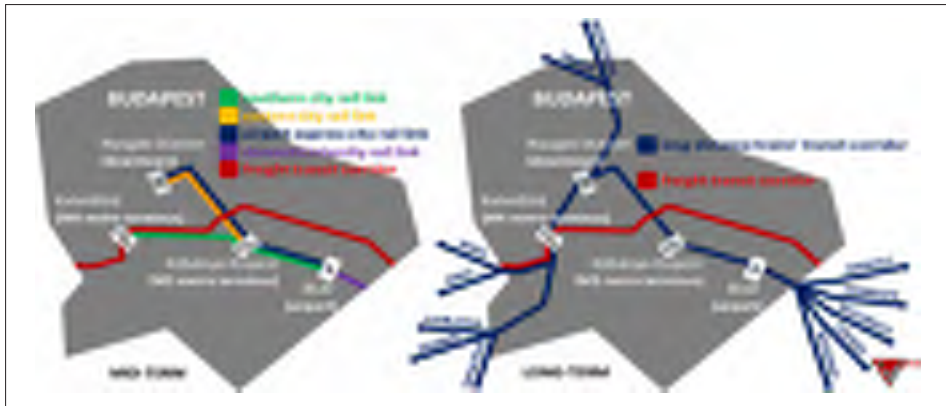
Because all the long distance fast trains will be removed from the hundred km long Budapest—Újszász—Szolnok line, here the capacity for freight services would increase a lot, and the speed of all cargo trains could be higher, because they would not have to stop waiting for the fast trains passing by, Figure 5.



**Figure 5** This figure shows the routes of cargo trains (red), all proposed new tracks (green) and the routes and number of passenger trains in a two hours period (blue)

#### 4.6 Connection in stations

To increase capacity, it is very important to build connections in a way which minimizes level crossings between trains. For this, it is important to plan all the routes: To minimize the number of level crossings we propose that all the long distance trains which use the new line run to or from Budapest-Nyugati station, Figure 6.



**Figure 6** All currently planned projects are steps for the final aim to free the whole Budapest railway infrastructure from the long distance trains by creating a dedicated corridor for them

## 5 Conclusion, long-term vision

Infrastructure development always needs a huge amount of public money, and railway infrastructure is generally less popular than roads or motorways. In the railway sector it is especially important to plan a kind of infrastructure improvements that can ensure solutions for several problems. The planned railway link through Budapest International Airport seems to be a good example for this approach. It not only offers a sustainable connection from Budapest and also from Eastern-Hungarian cities to the airport (by existing services). It also allows to increase the frequency of suburban trains to a fifteen minute interval (which is the minimum for being able to take part in the city transport system) and it creates enough free capacity to establish a freight transit corridor through Budapest. This project has to be combined with some other connecting infrastructure development projects which have multiple functions as well.

It is important to plan in a cost effective way, but it is not enough. It is also very important to fit each project into a long-term strategy. The main problem of the railway system in Hungary is that it is Budapest-centric. For being able to significantly increase any kind of rail traffic, we have to remove long distance trains on the rest of the lines as well. The proposed solution with further development is suitable for solving this problem on the Budapest—Újszász—Szolnok and on Budapest—Gödöllő—Hatvan lines as well. It also fits to the tunnel under the city and the Danube between Budapest-Nyugati and Kelenföld stations, which is in the long term transportation concept of Budapest area. [5]

The planning of the project is running, the authors participate as experts in this. The paper reflects their professional views and not the official position of the represented companies.

## References

- [1] Tóth, G., Kincses, Á., Nagy, Z.: European Spatial Structure LAP LAMBERT Academic Publishing, 2014.
- [2] [http://www.ahkungarn.hu/fileadmin/ahk\\_ungarn/Dokumente/Wirtschaftsinfos/HU/Statistik/INFO\\_HU\\_Aussenhandel\\_Ranking.pdf](http://www.ahkungarn.hu/fileadmin/ahk_ungarn/Dokumente/Wirtschaftsinfos/HU/Statistik/INFO_HU_Aussenhandel_Ranking.pdf)
- [3] <http://countries.bridgat.com/index.html>
- [4] Borza, V., Földiák, J.: Integrated Periodic Timetable in Hungary – experiences, help for vision, 2<sup>nd</sup> International Conference on Road and Rail Infrastructure - CETRA 2012, pp. 831-840, 7-9 May 2012, Dubrovnik, Croatia.
- [5] FŐMTERV-Közlekedés konzorcium: Budapesti regionális gyorsvasúti rendszer koncepciója, 2008



## 8 INFRASTRUCTURE PROJECTS





## ONE MODEL FOR RAIL PROJECTS EVALUATION WITH INTERVAL-VALUED FUZZY NUMBERS

Dragana Macura<sup>1</sup>, Marko Kapetanovic<sup>1</sup>, Nebojsa Bojovic<sup>1</sup>, Milutin Milosevic<sup>2</sup>

<sup>1</sup> Faculty of Transport and Traffic Engineering, University of Belgrade, Serbia

<sup>2</sup> “Beograd čvor”, Belgrade, Serbia

### Abstract

Different heterogenous criteria have to be considered for rail projects evaluation process. Due to this fact many authors suggest applying the multicriteria decision making methods. Often in practice there is certain uncertainty and imprecision during the rail projects evaluation process. Fuzzy numbers are suitable for taking into account these characteristics of a model. We develop the model for rail projects evaluation using the interval-valued fuzzy AHP and interval-valued fuzzy TOPSIS. Model is tested on the real rail projects at Serbian rail network. The proposed approach is suitable for making the transport projects evaluation model, with consideration of all conditions at real transport market.

*Keywords: Rail projects evaluation, Interval-valued fuzzy numbers, AHP, TOPSIS*

### 1 Introduction

Multi-criteria methods for transport projects evaluation are suitable approaches because of the presence of many heterogenous criteria relevant in this process. When these criteria or their mutual relations are uncertain and imprecise the application of the fuzzy logic is suggested. Interval-valued fuzzy sets are an extension of fuzzy sets and provide more adequate description of uncertainty and imprecision than traditional fuzzy sets. Interval-valued fuzzy sets can be used when there is a problem in determining the exact membership values of the elements, so in that cases, the intervals are used as membership values.

Authors develop the model for rail projects based on the interval-valued fuzzy AHP and interval-valued fuzzy TOPSIS. The suggested model is based on real data from the project (“Rail Rehabilitation in Serbia: Technical Assistance for Railway Infrastructure” – Rail Master Plan in Serbia, EIB, 2012).

### 2 Methodology

The concept of interval-valued fuzzy sets was proposed by Gorzalczany [1]. In their paper, Yao & Lin [2] represented interval-valued fuzzy set. Fig. 1 shows the interval-valued triangular fuzzy number (IVTFN)  $\bar{A}$  which consists of the lower triangular fuzzy number  $\bar{A}^l$  and the upper triangular fuzzy number  $\bar{A}^u$ .



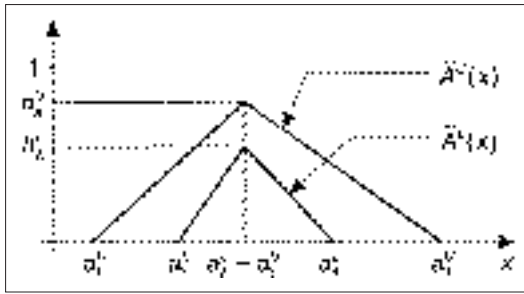


Figure 1 Interval-valued triangular fuzzy number

In order to represent the IVTFN shown above, following notation is used:

$$\bar{A} = \left[ (a_1^L, a_2^L, a_3^L; h_A^L), (a_1^U, a_2^U, a_3^U; h_A^U) \right] \quad (1)$$

where  $a_1^L, a_2^L, a_3^L, a_1^U, a_2^U, a_3^U$  are crisp values, and  $0 \leq h_A^L \leq h_A^U \leq 1$ . Chen [3] presented the arithmetic operations between IVTFNs.

With the aim of rail projects evaluation and ranking, this paper proposes two-stage analysis. In the first stage, the interval-valued fuzzy AHP (IVF-AHP) is used to determine the preference weights of evaluation [4]. In the second stage, using obtained preference weights by IVF-AHP, interval-valued fuzzy TOPSIS (IVF-TOPSIS) method is employed in order to improve the gaps of alternatives between real performance values and achieve aspiration levels [5] and to evaluate and rank rail projects observed.

### 2.1 The interval-valued fuzzy AHP

Considering shortcomings of pure AHP method, such as not taking into account the uncertainty associated with the process involved [5], this paper proposes integration of fuzzy theory and AHP in order to improve the uncertainty, by using IVTFNs. The steps in IVF-AHP implemented in this paper are presented as follows:

**Step 1:** Building the evaluation hierarchy system for evaluating and ranking alternatives, considering criteria involved.

**Step 2:** Defining the linguistic variables for the pair-wise comparison of criteria in terms of importance. In this paper, seven linguistic variables are used in pair-wise comparison of criteria importance, as shown in Table 1.

Table 1 Linguistic variables for pair-wise comparison of criteria

Linguistic variable	IVTFN
Very High (VH)	[(6,7,8;0.9),(5,7,9;1)]
High (H)	[(5,6,7;0.9),(4,6,8;1)]
Medium High (MH)	[(4,5,6;0.75),(3,5,7;1)]
Medium (M)	[(3,4,5;0.75),(2,4,6;1)]
Medium Low (ML)	[(2,3,4;0.5),(1,3,5;1)]
Low (L)	[(1,2,3;0.5),(1,2,4;1)]
Very Low (VL)	[(1,1,1;1),(1,1,1;1)]

**Step 3:** Constructing the pair-wise comparison matrices among all the criteria in the dimensions of the hierarchy system, by assigning linguistic terms to the pair-wise comparisons.

**Step 4:** Determining fuzzy geometric mean by using geometric mean technique [6]. The fuzzy geometric mean is defined as:

$$\bar{r}_i = (\bar{c}_{i1} \times \dots \times \bar{c}_{ij} \times \dots \times \bar{c}_{in})^{1/n} \quad (2)$$

where  $\bar{c}_{ij}$  is a IVTFN representing comparison value of dimension  $i$  to criterion  $j$ .

**Step 5:** Determining fuzzy weights of each criterion by:

$$\bar{w}_i = \bar{r}_i / (\bar{r}_1 + \dots + \bar{r}_i + \dots + \bar{r}_n) \quad (3)$$

## 2.2 The interval-valued fuzzy TOPSIS

Suppose MCDM problem has  $m$  alternatives ( $A_1, \dots, A_m$ ) and  $n$  decision criteria ( $C_1, \dots, C_n$ ). Each alternative is evaluated with respect to  $n$  criteria. Considering the fact that, in some cases, determining exact value for the elements of decision matrix is difficult, these values can be treated as fuzzy numbers [7]. The IVF-TOPSIS method applied in this paper consists of following steps:

**Step 1:** Determining the weighting of evaluation criteria by IVF-AHP.

**Step 2:** Constructing the fuzzy performance (decision) matrix using the appropriate linguistic variables for the alternatives with respect to the criteria:

$$\bar{D} = [\bar{x}_{ij}]_{m \times n}, \quad i = 1, \dots, m; j = 1, \dots, n \quad (4)$$

**Step 3:** Determining the normalized fuzzy decision matrix:

$$\bar{R} = [\bar{r}_{ij}]_{m \times n}, \quad i = 1, \dots, m; j = 1, \dots, n \quad (5)$$

by using the following formula:

$$\bar{r}_{ij} = \left[ \left( \frac{(x_{ij}^L)_1}{(x_j^+)_3}, \frac{(x_{ij}^L)_2}{(x_j^+)_3}, \frac{(x_{ij}^L)_3}{(x_j^+)_3}; h_{\bar{x}_{ij}}^L \right), \left( \frac{(x_{ij}^U)_1}{(x_j^+)_3}, \frac{(x_{ij}^U)_2}{(x_j^+)_3}, \frac{(x_{ij}^U)_3}{(x_j^+)_3}; h_{\bar{x}_{ij}}^U \right) \right] \quad (6)$$

where  $(x_j^+)_3^U = \max_i \{(x_{ij}^U)_3 | j = 1, \dots, n\}$ ,  $i = 1, \dots, m; j = 1, \dots, n$ .

**Step 4:** Determining the weighted fuzzy normalized decision matrix:

$$\bar{U} = [\bar{u}_{ij}]_{m \times n}, \quad i = 1, \dots, m; j = 1, \dots, n \quad (7)$$

where  $\bar{u}_{ij} = \bar{r}_{ij} \times \bar{w}_j$ .

**Step 5:** Determining the IVF positive-ideal solution (IVFPIS) and IVF negative-ideal solution (IVFNIS). Defining the aspiration levels and the worst levels as:

$$\bar{A}^+ = (\bar{u}_1^+, \dots, \bar{u}_j^+, \dots, \bar{u}_n^+) \quad (8)$$

$$\bar{A}^- = (\bar{u}_1^-, \dots, \bar{u}_j^-, \dots, \bar{u}_n^-) \quad (9)$$

where  $\bar{u}_j^+ = [(1,1,1;1),(1,1,1;1)] \times \bar{w}_j$  and  $\bar{u}_j^- = [(0,0,0;1),(0,0,0;1)] \times \bar{w}_j, j = 1, \dots, n$ .

**Step 6:** Unlike the common practice in the fuzzy TOPSIS application, where the distance from positive ideal solution and negative ideal solution are identified (e.g. [5], [8]), this paper considers the degree of similarity  $S \in [0,1]$ , proposed by Chen & Chen [9]. The degree of similarity between each alternative and IVFPIS and IVFNIS is identified by:

$$S_i^+ = \sum_{j=1}^n S(\bar{u}_{ij}, \bar{u}_j^+) = \sum_{j=1}^n \left( 1 - \frac{\sum_{k=1}^3 \left| \left( (u_{ij})_k^u - (u_{ij})_k^l \right) - \left( (u_j^+)_k^u - (u_j^+)_k^l \right) \right|}{3} \right) \quad (10)$$

$$S_i^- = \sum_{j=1}^n S(\bar{u}_{ij}, \bar{u}_j^-) = \sum_{j=1}^n \left( 1 - \frac{\sum_{k=1}^3 \left| \left( (u_{ij})_k^u - (u_{ij})_k^l \right) - \left( (u_j^-)_k^u - (u_j^-)_k^l \right) \right|}{3} \right) \quad (11)$$

where  $i = 1, \dots, m$ . Two interval-valued fuzzy numbers  $\bar{A}$  and  $\bar{B}$  are identical if and only if  $S(\bar{A}, \bar{B}) = 1$ .

**Step 7:** Considering that the degree of similarity is used in this paper instead of distance, the relative similarity is analogy defined instead of relative closeness. Relative similarity is calculated by:

$$R_i = \frac{S_i^-}{S_i^+ + S_i^-}, i = 1, \dots, m \quad (12)$$

**Step 8:** Alternatives are ranked in terms of their relative similarity, where, in this case, the highest ranked alternative has the lowest relative similarity score.

### 3 Case study

The aim of this paper is evaluation and ranking of rail projects by methodology described. The nine projects observed in this paper are presented in Table 2.

**Table 2** Rail projects included in the analysis

Alternative	Project
A <sub>1</sub>	Beli Potok – Pancevo
A <sub>2</sub>	Stara Pazova – HU Border
A <sub>3</sub>	Stara Pazova – CRO Border
A <sub>4</sub>	Rakovica – Velika Plana
A <sub>5</sub>	Resnik – Trupale
A <sub>6</sub>	Sicevo – BUG Border
A <sub>7</sub>	Doljevac – MK Border
A <sub>8</sub>	Resnik – ME Border
A <sub>9</sub>	Pancevo – RO Border

Rail projects evaluation hierarchy system is presented in Fig. 2. The first level criteria consists of two criteria, while the second level criteria consists of six sub-criteria. The elements and the model structure are defined in the project – Rail Master Plan in Serbia. The two criteria within 1<sup>st</sup> level criteria are:

- C<sub>1</sub> – Strategic and functional indicators;
- C<sub>2</sub> – Social indicators.

The six sub-criteria are:

- $C_{11}$  – Remove specific bottlenecks or other specific critical issues;
- $C_{12}$  – Improve functionality and better connectivity;
- $C_{21}$  – Number of inhabitants affected by the project;
- $C_{22}$  – Cost / effectiveness;
- $C_{23}$  – Market development (regarding unemployment rate);
- $C_{24}$  – Economic feasibility (EIRR).

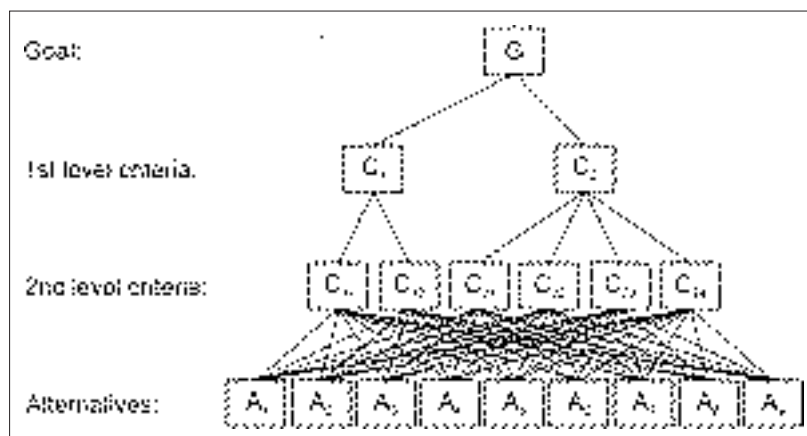


Figure 2 Rail projects evaluation hierarchy system

Regarding the importance of 1<sup>st</sup> level criteria, both criteria are considered as equally as important, thus having weights  $w_1 = 0.5$  and  $w_2 = 0.5$ . The pair-wise comparison matrices among sub-criteria, determined using linguistic variables presented in Table 1, are:

$$\bar{C1} = \begin{matrix} & C_{11} & C_{12} \\ C_{11} & \begin{bmatrix} 1 & L \end{bmatrix} \\ C_{12} & \begin{bmatrix} L^{-1} & 1 \end{bmatrix} \end{matrix} \quad \bar{C2} = \begin{matrix} & C_{21} & C_{22} & C_{23} & C_{24} \\ C_{21} & \begin{bmatrix} 1 & H^{-1} & MH & H^{-1} \end{bmatrix} \\ C_{22} & \begin{bmatrix} H & 1 & MH & L^{-1} \end{bmatrix} \\ C_{23} & \begin{bmatrix} MH^{-1} & MH^{-1} & 1 & H^{-1} \end{bmatrix} \\ C_{24} & \begin{bmatrix} H & L & H & 1 \end{bmatrix} \end{matrix}$$

Based on Eqs. (2) and (3), fuzzy geometric mean and fuzzy weights of each sub-criterion are determined. Finally, since there are two criteria levels, final fuzzy weights which are used in second stage are obtained by multiplying fuzzy weights of sub-criteria with the weights of 1<sup>st</sup> level criteria (Table 3).

Table 3 Fuzzy weights of IVF-AHP process for each sub-criterion

Fuzzy weight	IVFN
$\bar{w}_{11}$	[(0.05, 0.09, 0.14; 0.5), (0.05, 0.09, 0.18; 1)]
$\bar{w}_{12}$	[(0.03, 0.04, 0.08; 0.5), (0.02, 0.04, 0.09; 1)]
$\bar{w}_{21}$	[(0.03, 0.04, 0.06; 0.5), (0.02, 0.04, 0.07; 1)]
$\bar{w}_{22}$	[(0.08, 0.12, 0.21; 0.5), (0.06, 0.12, 0.25; 1)]
$\bar{w}_{23}$	[(0.01, 0.02, 0.03; 0.5), (0.01, 0.02, 0.04; 1)]
$\bar{w}_{24}$	[(0.11, 0.18, 0.28; 0.5), (0.09, 0.18, 0.36; 1)]

The next step in the analysis is determining the decision matrix. While some values can be determined precisely, as a crisp value, some of them are rather uncertain, thus IVTFN are used. Values used in determining the decision matrix with regard to each sub-criterion are presented in Table 4.

**Table 4** Values used in determining the decision matrix.

Sub-criteria	Value (Description)
C <sub>11</sub>	0 (No)
	1 (Yes)
C <sub>12</sub>	1 (Between the sections of the TEN-T in Serbia and the EU TEN-T)
	2 (Between sections of the TEN-T network in Serbia)
	3 (Between sections of other international corridors in Serbia)
	4 (Between local routes in Serbia)
C <sub>21</sub>	[(0,0,400000;0.85),(0,0,500000;1)] (Low Population – LP)
	[(200000,500000,900000;0.85),(100000,550000,1000000;1)] (Medium Population – MP)
	[(700000,1100000,1100000;0.85),(600000,1100000,1100000;1)] (High Population – HP)
C <sub>22</sub>	amount _  (Value of investment / overall daily traffic at year 2017)
C <sub>23</sub>	[(0,0,10.28;0.8),(0,0,11.28;1)] (Low Unemployment – LU)
	[(8.28,18.56,18.56;0.8),(7.28,18.56,18.56;1)] (High Unemployment – HU)
C <sub>24</sub>	% _  (Economic internal rate of return – EIRR)

Using values defined in Table 4, the performance of each alternative is evaluated with respect to each sub-criteria. The performance (decision) matrix for the alternatives with respect to each sub-criteria is:

		C <sub>11</sub>	C <sub>12</sub>	C <sub>21</sub>	C <sub>22</sub>	C <sub>23</sub>	C <sub>24</sub>
D =	A <sub>1</sub>	1	2	MP	4.28	LU	12.56
	A <sub>2</sub>	1	1	MP	7.53	HU	17.01
	A <sub>3</sub>	1	1	MP	3.08	LU	13.15
	A <sub>4</sub>	1	2	HP	8.88	HU	14.83
	A <sub>5</sub>	1	2	HP	6.59	HU	17.35
	A <sub>6</sub>	1	1	MP	4.99	HU	6.68
	A <sub>7</sub>	1	1	MP	8.07	HU	8.6
	A <sub>8</sub>	1	3	MP	19.00	LU	19.56
	A <sub>9</sub>	0	3	LP	3.15	LU	7.37
	Objective	max	min	max	min	max	max

Following the methodology described in Sec. 2, normalisation and weighting of decision matrix is conducted, and the aspiration levels are determined based on objective in terms of minimizing or maximizing. Finally, relative similarity scores and ranking of alternatives are presented in Table 5.

**Table 5** Relative similarity scores and ranking of rail projects.

Alternative	Project	$R_i$	Rank
$A_1$	Beli Potok – Pancevo	0.498408	5
$A_2$	StaraPazova – HU Border	0.497405	2
$A_3$	StaraPazova – CRO Border	0.497898	3
$A_4$	Rakovica – Velika Plana	0.498220	4
$A_5$	Resnik – Trupale	0.497379	1
$A_6$	Sicevo – BUG Border	0.499484	8
$A_7$	Doljevac – MK Border	0.499397	7
$A_8$	Resnik – ME Border	0.498728	6
$A_9$	Pancevo – RO Border	0.501243	9

## 4 Conclusions

In this paper the model for rail projects evaluation is developed. In two-stage analysis authors use the interval-valued fuzzy AHP, to determine the preference weights of evaluation, and interval-valued fuzzy TOPSIS, to evaluate and rank rail projects. Interval-valued fuzzy sets are used in order to consider uncertainty and imprecision of inputs. The model is tested on the real rail infrastructure projects relevant for Serbian railways. Future researches will include more criteria and their mutual relations.

## References

- [1] Chen, S.H.: Ranking fuzzy numbers with maximizing set and minimizing set, *Fuzzy Sets and Systems*, 17, pp. 113-129, 1985.
- [2] Chen, S.-M., Chen, J.-H.: Fuzzy risk analysis based on similarity measures between interval-valued fuzzy numbers and interval-valued fuzzy number arithmetic operators, *Expert Systems with Applications*, 36, pp. 6309–6317, 2009.
- [3] Gorzalczany, M.B.: A method of inference in approximate reasoning based on interval-valued fuzzy sets, *Fuzzy Sets and Systems*, 21, pp. 1-17, 1987.
- [4] Hsieh, T.Y., Lu, S.T., Tzeng, G.H.: Fuzzy MCDM approach for planning and design tenders selection in public office buildings, *International Journal of Project Management*, 22, pp. 573-584, 2004.
- [5] Kaya, T., Kahraman, C.: An integrated Fuzzy AHP–ELECTRE methodology for environmental impact assessment, *Expert Systems with Applications*, 38, pp. 8553–8562, 2011.
- [6] Macura, D., Bošković, B., Bojović, N., Milenković, M.: “A model for prioritization of rail infrastructure projects using ANP”, *International Journal of Transport Economics*, Vol. XXXVIII, No. 3, pp. 265-289, 2011.
- [7] Macura, D., Nuhodžić, R., Bojović, N., Knežević, N.: “One model for rail infrastructure projects selection”, *CETRA*, Dubrovnik, 7-9 May, Proceedings of papers, pp. 533-538, 2012.
- [8] Mandić, K., Delibasić, B., Knezević, S., Benković, S.: Analysis of the financial parameters of Serbian banks through the application of the fuzzy AHP and TOPSIS methods, *Economic Modelling*, 43, pp. 30–37, 2014.
- [9] Mokhtarian, M.N., Hadi-Vencheh, A.: A new fuzzy TOPSIS method based on left and right scores: An application for determining an industrial zone for dairy products factory, *Applied Soft Computing*, 12, pp. 2496-2505, 2012.
- [10] Vinodh, S., Prasanna, M., Hari Prakash, N.: Integrated Fuzzy AHP–TOPSIS for selecting the best plasticrecycling method: A case study, *Applied Mathematical Modelling*, 38, pp. 4662–4672, 2014.
- [11] Yao, J.S., Lin, F.T.: Constructing a fuzzy flow-shop sequencing model based on statistical data, *International Journal of Approximate Reasoning*, 29, pp. 215-234, 2002.





## INVESTMENTS IN INFRASTRUCTURE THROUGH PPP IN SPAIN PAST ACHIEVEMENTS AND CURRENT TRENDS

Alejandro Lopez Martinez<sup>1</sup>, Cesar Queiroz<sup>2</sup>

<sup>1</sup> OHL – Strategic Planning, Madrid, Spain

<sup>2</sup> Consultant on Roads and Transport Infrastructure, Former World Bank Highways Adviser, Washington, D.C., USA

### Abstract

Concessions and public-private partnership (PPP) agreements appear to be an adequate approach to tackle infrastructure deficit and promote sustainability in the road sector. However, when different models are analyzed in several countries and regions, successful stories are not always found. In order to build a successful story, several steps are needed, including political commitment and clear policy, competent public administration, a legislative framework to enable PPP, availability of both public and private capital, and willingness to invest by the private sector. Also, a positive economic framework is a contributing success factor. This paper reviews the required legal framework that supports the concept of PPP, such as a suitable procurement law promoting a competitive selection of concessionaires, the transfer of risks to the private sector, and the use of minimum revenue guarantees to mitigate risks, focusing on the case of Spain. It also discusses past success stories and current trends as a consequence of the financial crisis. Spain has a dense road network of more than 165,000 kilometers in an area of approximately 500,000 square kilometers. Highways and high capacity corridors represent more than 15,000 kilometers and many of them are managed through a PPP scheme. A review of basic PPP concepts under the Spanish PPP law is presented, including recent policy changes, pointing out the main responsibilities of the public and private partners in the process. Furthermore, the paper describes the PPP bidding process emphasizing the different steps of the process and how the stakeholders interact. The paper also describes good governance recommendations to ensure that the private sector's involvement yields the maximum benefit for the public, as well as future challenges for infrastructure concessions in Spain.

*Keywords: infrastructure, Spain, roads, PPP, concessions*

### 1 Introduction

Despite the financial crisis, the use of public-private partnerships (PPP) in the roads sector appears to be an adequate approach to release public funds for investments unable to attract private financing, tackle infrastructure deficit, and promote innovation and sustainability in the sector. One of the most used methods of implementing PPPs is through the road concession system, which basically consists of transferring construction, maintenance and operation of infrastructure to a private partner, in exchange for the right to charge a user fee for a period (i.e. the concession life).

Spain has a long experience implementing PPP projects in the road sector, which has been facilitated by an adequate PPP enabling environment. The first road concession was “the Gua-



darrama tunnel” in the north of Madrid region, opened to traffic in 1953. Since then, more than 2,800 km of road concession have been implemented across the different regions of Spain [1]. This paper describes the framework needed to create a PPP enabling environment, including a suitable procurement law promoting a competitive selection of concessionaires, the transfer of risks between the public and private sectors, the use of a structured bidding process and good governance practices, focusing on the case of Spain. The paper also analyzes the experience of Spanish companies delivering PPP, the challenges that all the stakeholders are facing in view of the financial crisis and possible solutions for PPP financing.

## 2 Legislative framework

In many countries the legislative system may not support the concept of PPP, such as the transfer of the responsibility to have a private entity provide a public service, and the suitability of procurement legislation for PPPs. A study by the European Bank for Reconstruction and Development (EBRD) illustrates that several countries, where concession legislation has low to medium compliance with international standards, have limited or no successful PPP programs [2]. However, countries such as Spain have specific PPP legislation and have established a successful PPP program. The Toolkit for PPP in Roads and Highways [3] states that a legislative framework includes two different types of laws:

- a) The laws that make PPP possible, also called the “enabling” law or framework, such as a country concession law or PPP law.
- b) The laws that may have an impact on a PPP project, which are numerous because PPPs are large and complex multi-faceted projects.

The enabling law could either be general or sector specific, including concession and PPP laws, and sector specific laws, as the case of Spain that will be described later in this paper.

## 3 Concession law

In order to establish an enabling environment for PPPs for a country, an appropriate concession law is fundamental. This law should apply to construction, expansion, rehabilitation and maintenance of assets providing a public service, aiming at improving the efficiency and modernization of public services. A concession law can be kept relatively simple and general, while specific regulation should be documented in operational guidelines (or decrees). A separation between law and regulation provides more flexibility for amendments during the implementation of a PPP program [4].

Concession laws typically identify the government agency responsible for overseeing the bidding, construction, and operation of the authorized projects and set parameters for each. Laws vary as to the rules of tender, but frequently involve a several-stage process.

## 4 The Spanish road sector

Spain has a dense road network of more than 165,000 kilometers (not including urban roads) in an area of approximately 500,000 square kilometers. Highways and high capacity corridors represent more than 15,000 kilometers and many of them are managed through a PPP scheme. Figure 1 shows the toll highway network in Spain.

More than 83 percent of all cargo and 87 percent of passengers are transported by road [5]. In Spain, toll highways are managed by the “Dirección General de Carreteras,” under the Ministerio de Fomento (Ministry of Public Works responsible for transportation in Spain).



**Figure 1** Toll highway network in Spain (Source: Asociación de Sociedades Españolas Concesionarias de Autopistas, Túneles Puentes y Vías de Peaje)

## 5 The Spanish PPP legal framework

The concession of toll highways in Spain has been regulated since 1972 by Law 8/1972: Toll Highways. Certain provisions of this law were subsequently repealed, notably those relating to the state guarantee for loans raised abroad and the exchange rate guarantee for the repayment of such loans at the original rate. Both articles were removed by Law 25/1988: Roads. A new law regulating the concession of public works was approved and enacted in 2003, Law 13/2003: Regulating the Concession of Public Works. This law updated different legal aspects of PPPs, including a new approach to the allocation of risk to the private concessionaire consistent with EU regulations, and updated further provisions of Law 8/1972: Toll Highways. In October 2007, a new Law of Public Sector Contracts was approved, Law 30/2007, superseding the previous Law 13/2003. The new law further develops the principle of PPP, making explicit provisions aimed at projects where a partnership between the public and the private sector is required.

An update of the Law of Public Sector Contracts was approved in March 2011, integrating all the previous provisions and also new requirements regarding private funding for public contracts [6].

The “Dirección General de Carreteras” is responsible for the technical regulation of road concessions granted by the Spanish national government. As for the financial regulation, a department in the Ministerio de Fomento called “Delegación de Gobierno en las Sociedades Concesionarias de Autopistas de Peaje”, is responsible for the coordination between the state and the concessionaires. This department is responsible for supervising the fulfillment of concession contracts, the evolution of the financial conditions and balance sheet of the different concessions, as well as their fares, traffic, operational information, and annual statements and reports [7].

## 6 The PPP bidding process

The Spanish PPP law provides for three distinct phases in the bidding process [8]:

- Public disclosure of feasibility studies. Depending on the project, economic-financial studies and preliminary design can also be disclosed. The standard bidding document that will be used during the process is disclosed at this phase.
- Once the comments and recommendations made during the public disclosure phase have been taken into consideration, the detailed design process starts, under the supervision of the “Dirección General de Carreteras”.
- Final phase is the actual bidding that must be publicly announced according to the law. Tenders are generally evaluated taking into account: (i) Technical quality; (ii) Feasibility of the proposal and technical and financial solvency of the concessionaire, and (iii) Efficiency of the concession scheme.

## 7 Risk sharing

Good practices for the public stakeholders to maximize the potential and to ensure the maximum general interest for PPP projects involve: affordability; value for money; fiscal rules and expenditure limits; risk sharing; the need for competition and transparency; regulatory issues; adequate institutional capacity; the public sector comparator; and the importance of political support [9]. The approach of the Spanish legal framework regarding risk sharing in infrastructure PPP projects is based on the following ideas [10]:

- Private stakeholders should be allocated most of the commercial risks.
- Public stakeholders should be allocated the risks that cannot be adequately managed by any other stakeholder.
- Public stakeholders may assume or mitigate some risks, but this assumption should generally avoid aggravating Spain’s public deficit. Public subsidies are contemplated as a means of rebalancing the financial aspects of the contract only in extremely justified circumstances, as their use is strongly constrained by the law.
- The risk mitigation must be understood in a symmetrical way, either in favor of the concessionaire or in favor of the public authority.

Figure 2 provides an overview of the main types of risks involved in a PPP project.

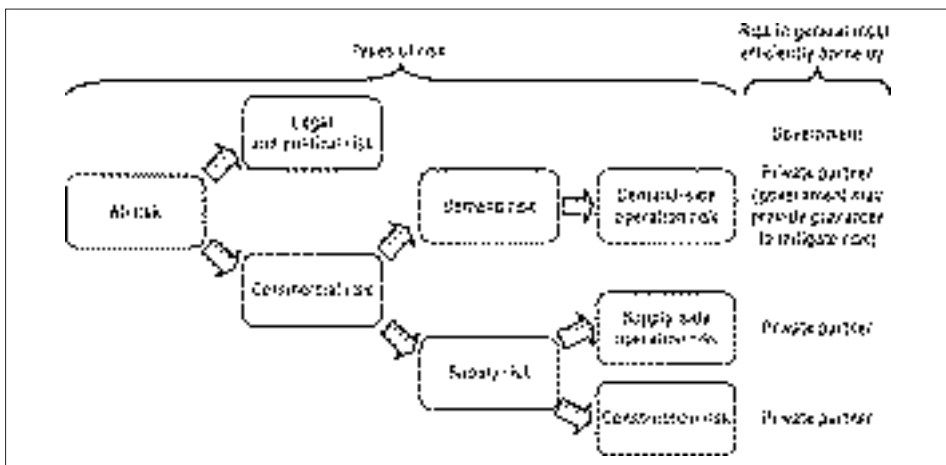


Figure 2 Categorizing PPP risks (Source: OECD 2008)

## 8 Current trends in Spain

PPPs and publicly managed assets have been vulnerable to the global financial crisis, affecting severely Spain and particularly its construction sector. The budget constraints and the credit restrictions are two factors disturbing the future development of the concessions market in Spain. In 2014, there were only 7 million euros tender processes for road concessions. The Spanish State General Administration only tendered 430 million euros in concessions in 2012 in opposition to the more than 8,000 million euros that were tendered in 2007 under “the first generation Highway Plan”. According to the figures of the association of major Spanish contractors and concessionaire groups, concession contracting under regional and local governments also dropped dramatically [11]. Table 1 gives the amounts in euros of concessions tendered in Spain in the period 2010 – 2014.

**Table 1** Concession tendering in Spain, in million euros (Source: SEOPAN)

Sector	2010	2011	2012	2013	2014
Ports	139.3	106.7	20	–	–
Roads	6,218.4	3,289.0	430	–	7.4
Railways	–	1,151.4	–	–	–
Airports	–	–	–	–	–
Hydraulic engineering	–	–	–	147.5	–
Urban mobility	1,410.9	–	–	–	–
Parking facilities	253.1	46.3	128.4	29.7	–
Health care	1,379.0	–	–	–	1,947.1
Local services	15.3	–	9.3	–	–
Others	1,098.7	197.7	32.9	–	289.9
<b>TOTAL</b>	<b>10,514.7</b>	<b>4,791.1</b>	<b>620.7</b>	<b>321.6</b>	<b>2,244.4</b>

Despite the situation in road concession tendering in Spain, 5 out of the top 10 Public Works Financing (PWF) ranking for transportation developers (based on capital invested in 2015) are Spanish companies [12]. These companies are present as concessionaires in many countries apart from Spain including: Argentina, Australia, Brazil, Canada, Chile, Colombia, Ecuador, Ireland, Israel, Jamaica, Mexico, Portugal, Puerto Rico, UK, and USA.

The success of Spanish companies abroad seems to indicate that the experience earned on PPP projects in Spain in the past is useful now in different regions of the world. Possible options for enhancing Spanish PPP financing include [13]:

- a) EU financial instruments to access new sources of capital and to complement bank lending;
- b) New EU grant regulation to increase the use of EU grant in PPPs; and
- c) Better project selection and monitoring to deliver more resilient projects and ensure their affordability/sustainability.

## 9 Good governance in PPP contracts

PPPs provide many benefits, but there are also many risks that have to be addressed and allocated, some of them particularly related to governance issues. Queiroz and Kerali discussed the governance risks in PPP projects and stated that, because PPP projects in transport infrastructure tend to have monopolistic features, good governance in managing them is essential to ensure that the private sector’s involvement yields the maximum benefit for the public [14].

Good governance requires, inter alia: (i) competitively selecting the strategic private investor; (ii) properly disclosing relevant information to the public; and (iii) having a regulatory entity oversee the contractual agreements over the life of the concession [15].

The Spanish PPP law fully complies with the recommendations stated by Queiroz and Izaguirre [15], including the competitive selection of the bidders and public disclosure of relevant information during the bidding process, as well as the existence of an agency, the “Dirección General de Carreteras”, overseeing the whole process.

The interests of the stakeholders are not always fully taken into account when developing PPP projects. In order to preserve such interests it is essential to put into place the enabling institutions, procedures, and processes surrounding PPPs. Examples of good governance principles include [16]:

- a) Participation: the degree of involvement of all stakeholders;
- b) Decency: the degree to which the formation and stewardship of the rules is undertaken without harming or causing grievance to people;
- c) Transparency: the degree of clarity and openness with which decisions are made;
- d) Accountability: the extent to which political actors are responsible to society for what they say and do;
- e) Fairness: the degree to which rules apply equally to everyone in society; and
- f) Efficiency: the extent to which limited human and financial resources are applied without waste, delay or corruption or without prejudicing future generations.

Governance can be enhanced by public disclosure of the contractual obligations of the concessionaries. Also, by carrying out periodic audit of PPP projects, using adequate expertise, and making the results available to the public, can contribute to assure public support to PPP and concession projects. Using survey tools such as “PPP Perception Index” seem to be an adequate instrument to measure perception of the PPP approach, including governance, from internal and external stakeholders [17]. In Spain, “Dirección General de Carreteras” is the public stakeholder ensuring that these principles are taken into consideration, including: maintaining transparent processes, avoiding corruption, ensuring fairness, and defining and monitoring the performance of the private stakeholders.

## 10 Conclusions

This paper reviewed investments in road infrastructure through PPP in Spain including past achievements and current trends. The case of Spain can be considered as one of the successful PPP stories, which is due, at least in part, to a well-established enabling environment for PPP. A large number of projects have been tendered since the first road concession was implemented in Spain in 1953, the regulatory framework is stable, the bidding process is adequate and has been implemented with a tight time schedule, reducing tendering costs and increasing competition. The financial crisis affected severely the road PPP market, reducing operations substantially. Some possible options for future Spanish PPP financing were presented. Good governance is also essential in managing PPP projects. Spanish PPP legal framework contributes to ensure the maximum benefit for all the stakeholders. One of the main tasks of “Dirección General de Carreteras” is ensuring that good governance principles are incorporated in the whole PPP process. As a conclusion, despite the reduction in concession tendering in Spain in recent years, the success of Spanish companies abroad seems to indicate that the PPP experience gained in Spain can be helpful to implement PPP projects elsewhere.

## References

- [1] Ministerio de Fomento: Anuario Estadístico 2014. <http://www.fomento.gob.es/> 18/03/16.
- [2] Legal Transition Programme: Legal Reform Projects, 1996 to September 2015. European Bank for Reconstruction and Development, London, UK, 2015.
- [3] Toolkit for PPP in Roads and Highways. World Bank and Public-Private Infrastructure Advisory Facility (PPIAF). Washington, D.C., USA, 2009.
- [4] Cesar, Q., Martinez, A.L.: Legal Frameworks for Successful Public Private Partnerships in The Routledge Companion to Public-Private Partnership. Edited by Piet de Vries, Etienne B. Yehoue. Routledge Companions in Business, Management and Accounting. Oxfordshire, UK, 2013.
- [5] Ministerio de Fomento: Los transportes y las infraestructuras, informe anual 2014. Gobierno de España. Madrid, Spain, pag. 27, 2014.
- [6] Concesiones – Regulación legal carreteras, Ministerio de Fomento, Gobierno de España, [https://sede.fomento.gob.es/SEDE\\_ELECTRONICA/LANG\\_CASTELLANO/OFICINAS\\_SECTORIALES/CARRETERAS/CONCESIONES/NORMATIVA/](https://sede.fomento.gob.es/SEDE_ELECTRONICA/LANG_CASTELLANO/OFICINAS_SECTORIALES/CARRETERAS/CONCESIONES/NORMATIVA/), 18/03/16.
- [7] Public private partnerships. Conference of European Directors of Roads 2009. Paris, France. <http://www.cedr.fr> 18/03/16.
- [8] Lopez Corral, A., Sánchez Soliño A., Carpintero López, S.: Las concesiones de infraestructuras y equipamientos públicos en España, Boletín económico del ICE nº2890. Madrid, Spain, 2006.
- [9] OECD, Public-Private Partnerships: In Pursuit of Risk Sharing and Value for Money, ISBN Number 9789264042797, Paris, France, 2008.
- [10] Vassallo, J.M., Gallego, J.: Risk-sharing in the New Public Works Concession Law in Spain, Madrid, Spain, 2005.
- [11] SEOPAN, Evolución de la Licitación de Concesiones de Obras por tipos de Obra y CCAA 2014. [www.seopan.es](http://www.seopan.es), 18/03/16.
- [12] PWF. Public Works Financing International Major Projects Report. New Jersey, USA. 2015.
- [13] Audibert, J., Totaro, F.: PPPs in Spain within the Operational Programme 2014-20, EPEC, European Investment Bank, Luxemburg, 2013.
- [14] Cesar, Q., Kerali, H.: A Review of Institutional Arrangements for Road Asset Management: Lessons for the Developing World, World Bank Transport Papers Series TP-32, Washington DC, 2010.
- [15] Cesar, Q., Izaguirre, A.K.: Worldwide Trends in Private Participation in Roads: Growing Activity, Growing Government Support, Gridlines series, no. 37, Public-Private Infrastructure Advisory Facility-PPIAF, Washington, DC., USA, 2008.
- [16] United Nations, Guidebook on Promoting Good Governance in Public-Private Partnerships, <http://www.unece.org/fileadmin/DAM/ceci/publications/ppp.pdf> 18/03/16.
- [17] Cesar, Q., Astesiano, G., Serebrisky, T.: An Overview of the Brazilian PPP Experience from a Stakeholders' Viewpoint, Inter-American Development Bank. Infrastructure and Environment Sector. Technical Note No. IDB-TN-641. Washington, D.C., USA, 2014.





## ENTRANCE TERMINAL OF THE PORT OF PLOCE – ENDPOINT OF THE VC CORRIDOR

**Boris Vidak**

*Institut IGH d.d., Department for Road Design, Split Regional Unit, CROATIA*

### Abstract

Corridor Vc in the length of 702 kilometers stretches from Budapest via Osijek and Sarajevo to the Port of Ploce. Luka Ploce is declared as a port of special international economic interest for the Republic of Croatia, and the completion of the planned projects of its development, will enable it to accept greater amount and specific types of cargo.

Construction of the entrance terminal with a border as an endpoint Vc corridor in order to develop the competitiveness of the Port of Ploce will provide superior technological and technical design to meet the needs of businesses. The valuation of the building is to over 85 million kn. Entrance terminal of the Port of Ploce together with the southern section of the Vc corridor within which the highways A1 and A10 are located, represents infrastructure project which has a special value in understanding the process of economic and transport integration of Northern and Central Europe with the Adriatic. This paper describes the main characteristics of the subject building.

### 1 Introduction

Construction of new modern port terminals for containers and bulk cargo – the Bulk Cargo Terminal and Container Terminal which modernize and increase the transfer capacity of the Port of Ploce requires the construction of a new road intersection with the checkpoint and the parking lots and ancillary building construction facilities related to the functioning of border crossing.

The Entrance Terminal of the Port of Ploce requires structural unit and a communication link between office buildings, checkpoint, parking lots, main road – speed (access) road and local access roads with the road connecting the Port of Ploce with the city.

Construction of the Entrance complex is based on the premise of constructing an overpass over the railroad tracks and the access road to the town of Ploce, which is built up through investment of HAC as the end of the connection road Ploce intersection (A1) – Cevaljusa intersection – Port of Ploce.

The subject intervention with the area of 50,000 m<sup>2</sup> is located on the extremity of the southern section of the Vc Corridor. It consists of the office building, the checkpoint with the access road (the continuation of the road from the direction of Cevaljusa), external parking lots for arriving cars and vehicles, internal parking lots for departing vehicles and supporting municipal infrastructure, Figure 1.

The goal of the investment is to get facilities and infrastructure according to the needs of the port truck traffic. It ensures the quality of working conditions for all users, and the use of new management and approach control systems will enable faster and more efficient flow of cargo. With the construction of these facilities the Port of Ploce becomes a modern logistics center which will allow the opening of other markets.



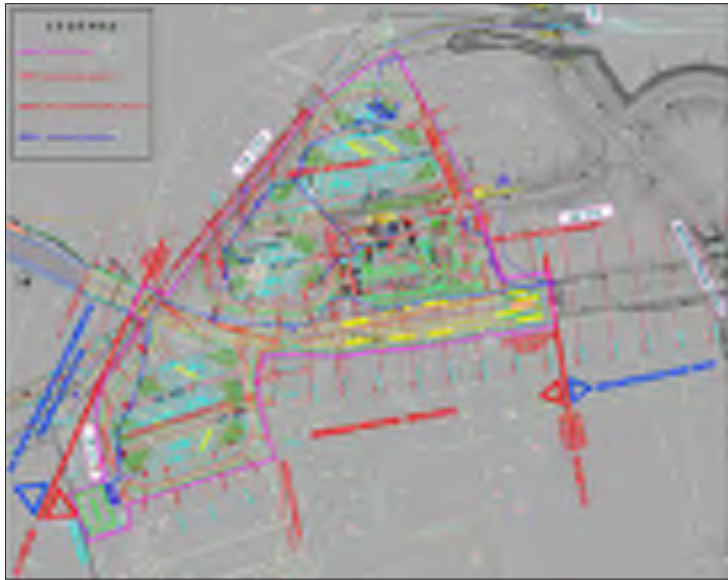


Figure 1 Overview of design solution of Entrance terminal of Port of Ploče with access road and parking lots

## 2 Description of the operation

### 2.1 Civil engineering facilities

#### 2.1.1 Access road

##### Technical elements

Speed Road – Connection road CP Karamatici – Port of Ploče of total length of 9.73 kilometers in this operation continues to the Port of Ploče as access road [1] and fits to the Main port road No. 2. The total length of the intervention is 318.460 m.

Speed road connects the town and the port of Ploče with highways A1 and A10, and therefore the route of the access road is extended to the existing entrance to the Port complex, in accordance with the extract from the Plan of Dubrovnik- Neretva County.

In the middle of the road on the north side the turnstile is designed for vehicles arriving into the Port of Ploče, and, which are required to leave the Port after passing the checkpoint, all according to the technological process of functioning within the port, or the requirements of the police and customs, Figure 2. The cross section is aligned with the so far constructed highway. It is planned with two carriageways without dividing strip, and each roadway has two lanes in width and 3.50 m and edge tape width 0.50 m. Within the zone of the checkpoint a central strip is extended to 6.00 m provided for vehicular balance. Verges with footpath 1.50 m wide are with total width of 2.00 m. Gradients slope embankment are predicted with 1:1.5. Clearance above the access road will be a minimum height of 4.50 m from the highest point of the pavement. The project for the access road provides the following pavement structure:

- Wearing layer of splitmastix asphalt SMA 11, thickness of 3.5 cm;
- Adhesive base layer VS 22, thickness of 7.0 cm ;
- Bituminous base layer BNS 32sA thickness of 9.0 cm;
- Mechanically compacted base layer, thickness minimum of 35.0 cm



Figure 2 Access road with turnstile, office facility and checkpoint

### Geotechnical conditions

The soil at the site of the road consists of from typical soft marine sediments and is extremely unfavorable geotechnical environment. For the subject road the solution [2] is applied of foundation soil by cement stabilization in a layer 40 cm below the carriageway and footpaths. In the area of the checkpoint, to ensure adequate soil bearing capacity and reducing subsidence in using an acceptable measure, derived gravel piles are constructed, with a diameter of 100 cm on which nonwoven geotextile and ballast on an extended surface 50 cm thick are applied.

#### 2.1.2 External and internal parking lots

Within the Entrance complex the construction of external and internal parking lot [3] is planned, and also of the truck parking areas for arriving and departing as well as for passenger cars. This will provide parking space for the employees of the Port such as customs, police, agencies, freight forwarders, service control and similar.

The cross section of local roads of parking lot has two lanes in width of 3.50 m. Verges are of planned width of 1.50 m. The total width of the cross section in the crown is 10.00 m. The project for parking lots and roads in the subject zone provides the following pavement structure:

- Asphalt-concrete wearing course AB 11, thickness of 5.0 cm;
- Bituminous base layer BNS 32sA, thickness of 8.0 cm;
- Mechanically compacted base course thickness minimum of 35.0 cm.

#### External parking lot

In the northern zone of the intervention – external parking lot for arriving cars the space is provided for one-time accommodation for 47 cargo trucks, space for 26 passenger cars in front of the entrance to the main building (+ 2 parking spaces for the disabled) and 55 passenger cars on the north side of the building. Parking lot is appropriately fenced and equipped with all necessary facilities including control systems, supervision and toll collection and is connected informatively with the office building.



Figure 3 External parking lot

### Internal parking lot

For departing vehicles, within the fence of the Port, in the southern zone of the intervention, an internal parking lot (Figure 4) is provided for vehicles awaiting an exit procedure. This project provides parking area that can accommodate 27 trucks and 20 cargo trucks.

Parking is equipped with all necessary facilities provided for control of the entire area, which is surrounded by a fence of the Zone. After leaving the parking lot, vehicles are directed to the access (speed) road and to the checkpoint, and further via “Ceveljusa” intersection by connection road toward the A1 motorway.



Figure 4 Internal parking lot

### **Geotechnical conditions**

The soil is saturated with groundwater that is, the level of groundwater is constant throughout the year around the ground surface, a minimum of about 50 cm below the surface of the flooded area, and the daily fluctuations are affected by tides.

Based on the experience gained during and after the construction of Ceveljusa intersection and the terminal in the Port of Ploče, which are located in the immediate vicinity, as a logical solution to improve soil and acceleration of consolidation improvement of the soil gravel piles with a diameter of 100 cm below the office building is applied [4] with the installation of prefabricated vertical drains of polypropylene and preload in excess of 30 % of ultimate load object for a period of 4 months .

For parking locations [5] the soil improvement using vertical drains with mounting nonwovens for separation of earth and stone material and preload in excess of 30 % of ultimate load for a period of 4 months is applied .

## **2.2 Building construction structures**

### **2.2.1 Office building**

#### **Purpose and organization of the building**

Office building of the Entrance terminal of the Port of Ploče [6] has a gross area 3776.00 m<sup>2</sup> distributed on two floors. Ground plan of the building has an irregular shape. From the central common space rectangularly shaped four rectangular branches (pavilions) go out, one north, one east and two west (north and south). The northern branch and the western (northern) branch are of the height of P + 1, while the eastern branch and the western (southern) branch are of the height P. The main entrance to the building is on the north side of the central part of the common space – the central hall. The side entrance is in the central part of the common area on the southern side and also leads to the central hall.

In the central part of the central hall the main reception area of the building is located, with the service information, receptions, post office, bank and currency exchange office. In the southern part of the central hall are vertical communications, evacuation elevator and single staircase, and a coffee bar, which has a terrace in the covered part of the south facade . Winter Garden is a landscaped outdoor area.

The entrance on the north facade through the windshield leads into the central hall. On the floor of the central hall is a restaurant, with a separate room for smoking, and the expansion of hall in front the main conference room.

The central hall and the ground floor and the first floor has the necessary sanitary block. The northern branch of the building, with the height of P + 1 has freight forwarding service organized. The eastern branch of the building, with the height of P, has police service organized. The western branch of the building with the height of P in the first half of its length has customs service organized and is entered through a central hall. The other half of the length of the hall is organized as truckstore which has an entrance from the outside, from the west.

In truckstore there are: an entrance hall, vault room, coffee bar with an uncovered terrace, storage and restrooms with dressing room for employees, kitchenette, toilet facilities for men, three bathrooms, a cleaners and laundry machine rooms. The western branch of the building with the height of P + 1 across its surface has a space for offices of the Port Authority. The ground floor and first floor are arranged for services of the Port authority according to the requirements of investors. On the floor of the west wing, at the junction with the Central Hall, there is a kitchen with office and aerial platform for food. The lifting platform connects ground and upper floor office.

## Structure

Office building is of ground plan indented shape, but in terms of altitude is composed of two floors. Structurally it is one unified unit. Branches of the building (west – south branch and western – northern branch) are with ground plan dimensions 13.30 x 42.00 m. The eastern branch of the building is with ground plan dimensions 13.30 x 26.40 m while the northern branch of the building has dimensions of 13.30 x 36.45 m. The central hall is L-shaped with dimensions of 28.95 x 10.65 branches and connects all branches of the building. The branches with the height of P + 1 (northern branch and the west-northern branch) have a height of 8.90 m, a height of arms P (eastern extension of the west – southern branch) have a height of 5.10 m above the finished surrounding terrain. The central hall has a height of 8.90 m above the finished surrounding terrain.



Figure 5 Ground plan of office building

Constructive solution provides a combination of monolithic and assembly design building construction. Assembly design of a structure includes: the performance of vertical and horizontal wall panels and performance of ceiling and roof structures.

### 2.2.2 Checkpoint

Within the Entrance complex, at the beginning of the route of the access road the construction of checkpoint building is planned [7]. It consists of a canopy, control facilities and vehicular balance. Checkpoint is also the border crossing to be used for control of goods and sealing of containers. Under the canopies are facilities for customs, police and security services and vehicular balance. Canopy with ground plan dimensions of 33.80 x 33.80 m covers the four traffic lanes, the islets are with two check boxes. One is intended for customs and another for the police and security guards.

In the checkpoint zone is lane with the width of 6.0 m to place vehicular balances. It is anticipated to install the vehicular balance with loading capacity of 60 tons (min. 15 tons of axle load) with dimensions of 18.0 m x 3.0 m. The maximum height of the canopy is 7.35 m and the maximum height of the control box is 3.20 m. The light passage under the canopy is 5.35 m, while the light height of check box is 2.80 m. The project for the checkpoint provides concrete pavement structure with the total thickness of  $d_{uk} = 62.0$  cm:

- Unreinforced concrete slab with the thickness of 22.0 cm, and the width of 3.50 m with the transverse dividing lines at a distance of 5.00 m;
- Base layer of crushed stone granular material stabilized with cement, with the thickness of 20.0 cm;
- Mechanically compacted base course with the thickness of 20.0 cm.



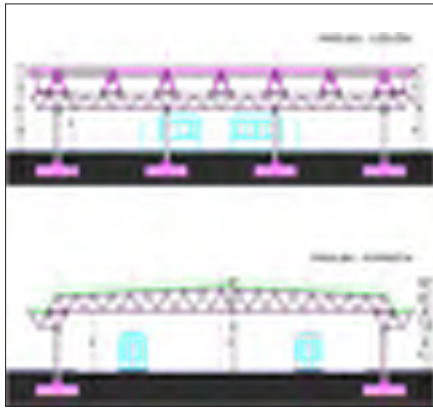


Figure 6 Checkpoint – longitudinal and cross section

### 2.3 Drainage and water protection

Design solutions for drainage and water protection [8] defines the system of structures whose function is controlled collection of pavement water, its purification and final safe disposal as a natural resource. Defining the relevant data for a particular area is estimated using ITP curve for MS Ploče. Drainage system as a closed system consists of collectors and grease traps. For the functionality of the drainage system of internal parking for discharging water from the retention the reconstruction of collector 'Maintenance – Channel Vlasca “ is planned, which is not the subject of this project. The drainage system of the external parking lot is connected to the retention by the lateral channel that will be built as part of the neighboring intervention of the “Croatian motorways”.

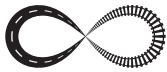
## 3 Conclusion

Building the Entrance Terminal of the Port of Ploče as an endpoint of the Vc Corridor represents an additional contribution to improved connection of northern and central Europe with the Adriatic. The Entrance terminal of the Port of Ploče with the southern section of the Vc corridor within which the highways A1 and A10 are, which extend from the Ploče intersection to the border of Bosnia and Herzegovina and the northern section of Corridor Vc in our country (motorway A5 Beli Manastir – Osijek – Svilaj ) presents two major infrastructural projects, which complement each other and have exceptional value in understanding the process of economic and traffic integration of the Central European area. The Entrance complex will certainly contribute to the growth and development of the Port of Ploče as a major economic power in this part of Croatia.

## References

- [1] Main construction design of the access road – Entrance terminal of the Port of Ploče with parking lots and access road, Institut IGH d.d., Split, February, 2016
- [2] Main geotechnical design of the access road – Entrance terminal of the Port of Ploče with parking lots and access road, Institut IGH d.d., Zagreb, December, 2011
- [3] Main construction design of the parking lot – Entrance terminal of the Port of Ploče with parking lots and access road, Institut IGH d.d., Split, July, 2014

- [4] Main geotechnical design of the Authority facilities and traffic control facilities – Entrance terminal of the Port of Ploče with parking lots and access road, Institut IGH d.d., Zagreb, February, 2016
- [5] Main geotechnical design of the parking lot – Entrance terminal of the Port of Ploče with parking lots and access road, Institut IGH d.d., Zagreb, December, 2011
- [6] Main architectural design of the office building – Entrance terminal of the Port of Ploče with parking lots and access road, Projektni biro AK d.o.o., Zagreb, February, 2016
- [7] Main architectural design of the checkpoint – Entrance terminal of the Port of Ploče with parking lots and access road, Projektni biro AK d.o.o., Zagreb, March, 2013
- [8] Main construction design of drainage and water protection – Entrance terminal of the Port of Ploče with parking lots and access road, Institut IGH d.d., Split, March, 2013



## MODEL TEST TO DETERMINE LOAD-SETTLEMENT CHARACTERISTICS ON SOFT CLAY USING PILE-RAFT SYSTEM

M. V. Shah, Devendra V. Jakhodiya, A. R. Gandhi

*Applied Mechanics Department, L.D. College of Engineering, Ahmedabad, India*

### Abstract

Due to the high complexity involved in behaviour of clays the pile-raft system seems to be the most viable approach to carry heavy loads. Very limited research work is available on this in context to soft clays using pile-raft system. Present research aims to study the elastic and non-elastic response of intergrated and non-integrated pile-raft system embedded in soft clay using physical model approach. The pile-raft model system is fabricated using Aluminum material for the slenderness ratio,  $L/D$ , 10 with suitable scale factor. The behavior was compared with responses of flexible unpiled raft, single pile, rigid pile groups. The effect of numbers of piles on the settlement, load improvements ratio and settlement reduction ratio are some of the major parameters presented and discussed.

*Keywords: settlement reducing pile, flexible raft, load improvement ratio, settlement reduction ratio*

### 1 Introduction

Raft and pile groups are the two alternative foundation options to support structures with heavy column loads. Raft is normally designed as rigid in order to withstand high moment and differential settlement, which is a function of intensity of load and relative stiffness of raft and soil. In the case of pile groups more number of piles is provided than required to cater the column load and to practically eliminate the settlement, which makes the foundation to be very expensive. The concept of pile raft was conceived and introduced about three decades back to overcome the difficulties stated above as well as for the effective utilization of the pile group. For most piled raft foundation, the primary purpose of the piles is to act as settlement reducers. The proportion of load carried by the piles is considered as a secondary issue in the design. However, it is observed that the design of foundations considering only the pile or raft is not a feasible solution because of the load sharing mechanism of the pile-raft-soil. Therefore, the combination of two separate systems, namely “Piled Raft Foundations” has been developed (Clancy and Randolph (1993)).

### 2 Experimental work

A series of laboratory tests were performed on models of unpiled raft, single pile and central piled raft to examine the settlement behavior of axially loaded pile-raft foundation system. Tests on 19 mm diameter Aluminum piles with single pile has been carried out for centrally located pile and same thickness of raft. Details of piles configuration and model raft dimensions adopted in present research work is shown in Fig. 1.



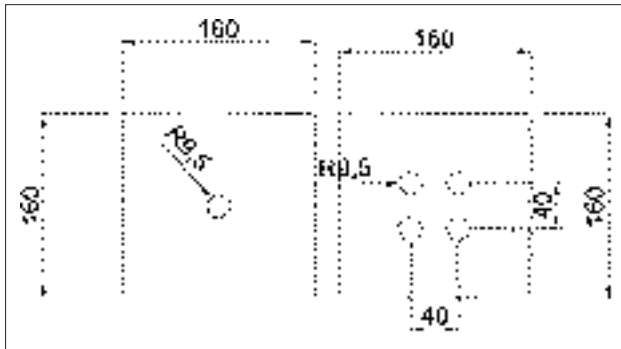


Figure 1 Details of piles arrangement (Dimensions in mm)

## 2.1 Experimental set-up

Tests were performed in a cylindrical mild steel vessel of 500 mm diameter and height of 500 mm. The mild steel base plate was also provided with four numbers of holes separated at  $120^\circ$  angle and distanced at  $R/2$ ,  $R/4$ ,  $2R/3$  and at center c/c for the drainage purpose. The loading frame consists of four vertical columns (C-Section) of 1 m height, two on each side and two horizontal beams (C-Section). The load was applied through a mechanical jack fixed at center as shown in Fig. 2. Two linear vertical displacement transducers (LVDTs) of 0.01 mm accuracy were located at the middle side of the raft, to measure vertical downward settlement.

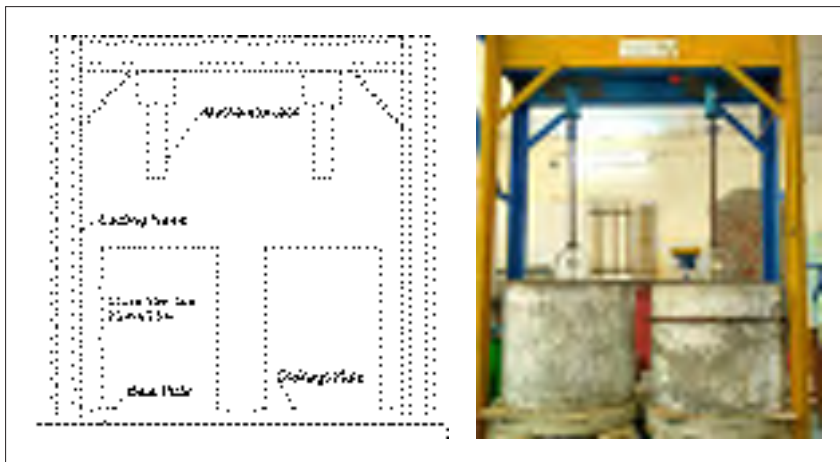


Figure 2 Schematic diagram and actual photograph of model test set-up

## 2.2 Properties of materials

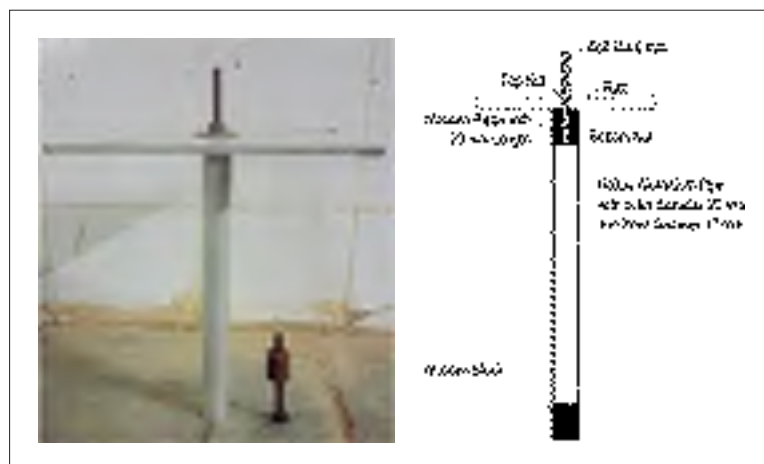
Marine soft clay is used to prepare soft clay bed. The index properties of soft clay is presented in Table 1.

**Table 1** Properties of soft marine clay

Index Property	Values
Specific gravity	2.47
Liquid limit [%]	55
Plastic limit [%]	21.31
Plasticity index [%]	33.69
Shrinkage limit [%]	17.16
Free swell index [%]	30.77

### 2.3 Model of raft and piles

Aluminum plates, with fixed thickness, served as model rafts. The dimensions of the raft was 160 mm × 160 mm × 4 mm. The modulus of elasticity and Poisson’s ratio of Aluminum plates were 70 GPa and 0.33, respectively. The model piles used in the experiments were Aluminum hollow pipes of 19 mm in outside diameter and 1.5 mm in wall thickness. The modulus of elasticity and Poisson’s ratio of the Aluminum pipe were 70 GPa and 0.33, respectively. The embedded pile lengths of 200 mm was used in the experiments. The lengths represent L/D ratios of 10. Top head of each pile was provided with a bolt of 6 mm in diameter with a wooden piece of 20 mm length to connect the pile to the cap through two nuts to ensure a complete fixation between the pile and the cap as shown in Fig. 3.



**Figure 3** Connection between the pile and the raft

## 3 Result and discussion

The model tests results obtained from laboratory tests are analysed and discussed in this section. The settlement equal to 10% of pile diameter or raft width is often adopted to define the ultimate load capacity in foundation design (Cerato et al. 2006, Lee et al. 1999, Lee et al. 2005). In this model tests, loading was continued till the raft settlement reaches 25 mm and pile settlement reaches 20 mm.

### 3.1 Effect of raft's thickness

As seen in Fig. 4. the increase in raft's thickness improves load bearing capacity of unpiled raft. The thickness of raft is selected such as the stiffness varying from very flexible raft to rigid raft. The load carrying capacity of unpiled increases by 6% and 13% at 10 mm settlement going from 2 mm thick raft to 4 mm and 8 mm thick raft respectively. Similarly the increment was 9% and 20% for 4 mm and 8 mm thick raft at 25 mm settlement.

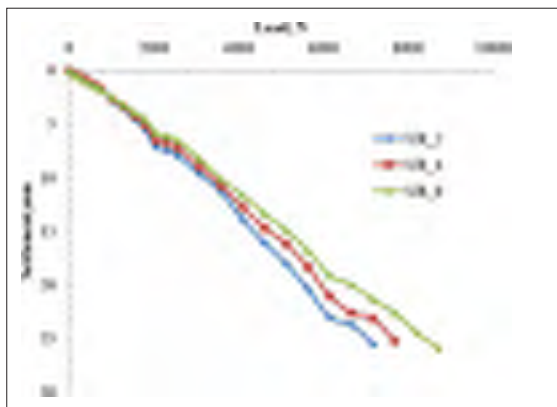


Figure 4 Load vs Settlement for 2 mm, 4 mm and 8 mm thickness of raft

### 3.2 Effect of number and length of pile in pile group

Figure 5 shows the effect of number of piles in pile group as well as effect of length of pile. As seen in the Fig. 5 the load carrying capacity increases as we increase length of pile and it also increases as we increase numbers of pile. The L/D ratio was 10 and 15, number of piles were 1 and 4. It is seen that in case of pile group of L/D=10, increasing pile number from 1 to 4 increases load carrying capacity at 10 mm settlement by 123% and at 20 mm settlement by 120%. For increased slenderness ratio i.e. L/D=15, increasing pile number from 1 to 4 increases load carrying capacity at 10 mm settlement by 170% and at 20 mm settlement by 117%. This shows that increasing length of pile is useful for small settlement at higher settlement the load carrying capacity is not increased appreciably.

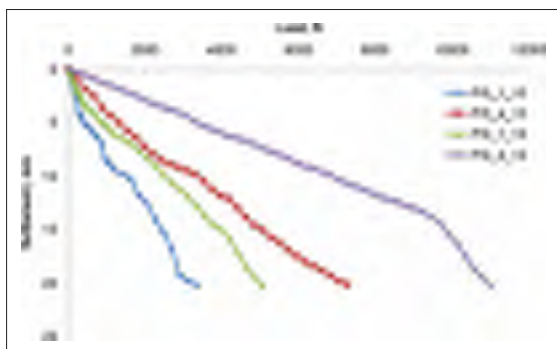


Figure 5 Effect of number of pile with slenderness ratio 10 and 15

### 3.3 Pile-raft system

Figure 6. shows the comparison of unpile raft of 2 mm thickness, pile group of L/D=10 and 15 with 1 and 4 number of piles and pile-raft system. It is seen in both Fig.6a) and 6b) as we combine unpile raft and pile group and form a pile-raft system its load carrying capacity is higher than unpile raft and pile group. As shown in Fig. 6a) the load carrying capacity of pile-raft for single pile increases by 14% at 10 mm settlement compared to unpile raft where the increase is 50% at 25 mm settlement. Also the load carrying capacity of pile-raft for four piles increases by 228% at 10 mm settlement compared to unpile raft where the increase is 306% at 25 mm settlement. Where as in Fig. 6b) the load carrying capacity of pile-raft for single pile increases by 30% at 10 mm settlement compared to unpile raft where the increase is 111% at 25 mm settlement. Also the load carrying capacity of pile-raft for four piles increases by 396% at 10 mm settlement compared to unpile raft where the increase is 451% at 25 mm settlement.

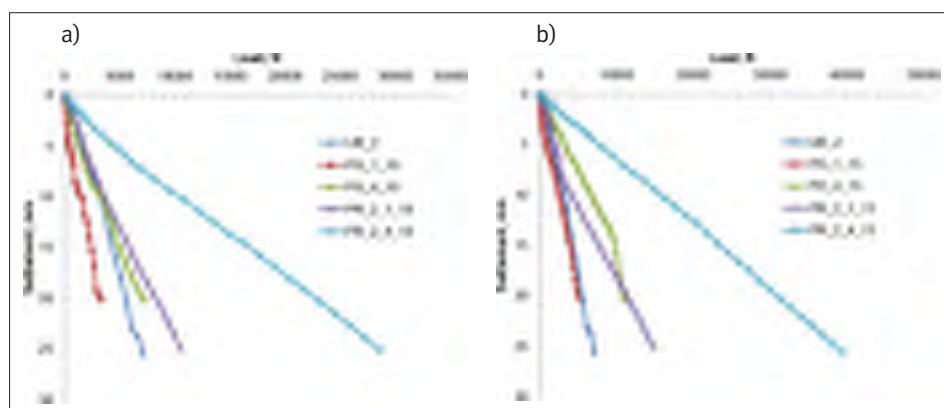
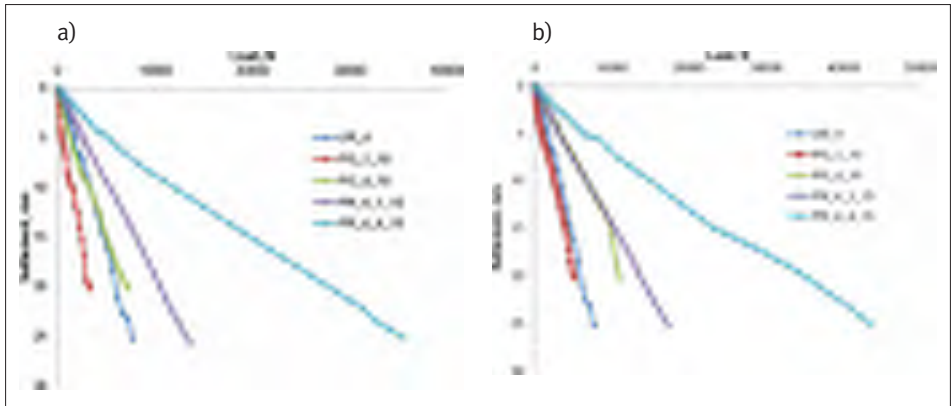


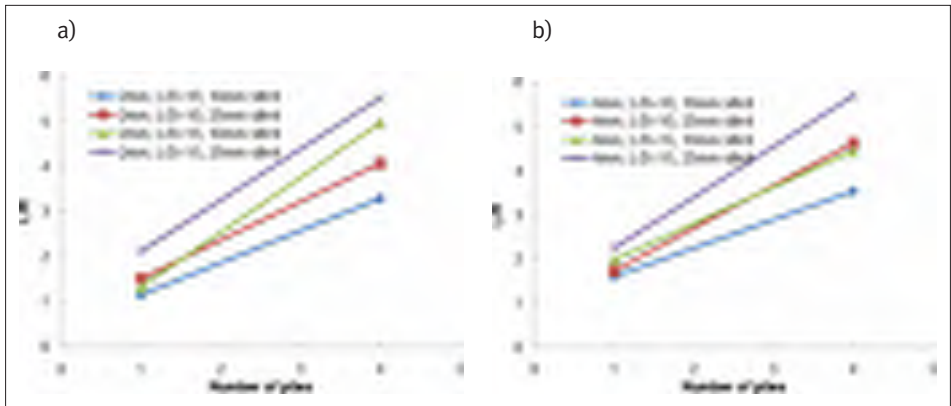
Figure 6 Load vs Settlement for pile-raft system: a) raft thickness 2 mm, L/D=10; b) raft thickness 2 mm, L/D=15

Figure 7. shows the comparison of unpile raft of 4 mm thickness, pile group of L/D=10 and 15 with 1 and 4 number of piles and pile-raft system. It is seen in both Fig.7a) and 7b) as we combine unpile raft and pile group and form a pile-raft system its load carrying capacity is higher than unpile raft and pile group. As shown in Fig. 7a) the load carrying capacity of pile-raft for single pile increases by 69% at 10 mm settlement compared to unpile raft where the increase is 88% at 25 mm settlement. Also the load carrying capacity of pile-raft for four piles increases by 275% at 10 mm settlement compared to unpile raft where the increase is 403% at 25 mm settlement. Where as in Fig. 7b) the load carrying capacity of pile-raft for single pile increases by 111% at 10 mm settlement compared to unpile raft where the increase is 145% at 25 mm settlement. Also the load carrying capacity of pile-raft for four piles increases by 372% at 10 mm settlement compared to unpile raft where the increase is 519% at 25 mm settlement.

Figure 8a) and 8b) show the variation of the load improvement ratio with the number of piles at 10 mm and 25 mm settlements, respectively. From these figures, it can be observed that for the given raft thickness, the value of load improvement ratio increases as the number of piles and length of piles beneath the raft increases e.g. as show in Fig.8a) at 10 mm settlement, for raft of thickness 2 mm, and pile with L/D=10, the value of load improvement ratio increases by 187%, while installing 4 piles. At 25 mm settlement the increment is 170%. Now for L/D=15; at 10 mm settlement, for raft of thickness 2 mm, the value of load improvement ratio increases by 278%, while installing 4 piles. At 25 mm settlement the increment is 161%.



**Figure 7** Load vs Settlement for pile-raft system: a) raft thickness 4 mm, L/D=10; b) raft thickness 4 mm, L/D=15



**Figure 8** Variation of load improvement ratio with the number of piles at 10 mm and 25 mm settlement: a) 2 mm thick raft; b) 4 mm thick raft

As show in Fig. 8b) at 10 mm settlement, for raft of thickness 4 mm, and pile with L/D=10, the value of load improvement ratio increases by 121%, while installing 4 piles. At 25 mm settlement the increment is 167%. Now for L/D=15; at 10 mm settlement, for raft of thickness 4 mm, the value of load improvement ratio increases by 124%, while installing 4 piles. At 25 mm settlement the increment is 153%.

The reduction in settlement of raft due to the presence of piles are represented by a non dimensional factor, called settlement reduction ratio, which was define as defined as the ratio of settlement of piled raft and unpiled raft at a given load.

$$\text{Settlement reduction ratio} = (\delta r - \delta pr) / \delta r \quad (1)$$

where,  $\delta r$  and  $\delta pr$  represents settlement of unpiled raft and piled raft for a given load.

Figure 9 shows the variation of settlement reduction ratio, with the number of piles for rafts with thickness of 2 mm and 4 mm. From these figure, it can be observed that; as the number of piles underneath the raft increases, the settlement reduction ratio increases. The rate of increase of settlement reduction ratio decreases as the thickness of raft increases (e.g. For raft thickness 2 mm, settlement reduction ratio increases by 413%, while installing 1 pile to 4

piles underneath the raft, while for raft thickness 4 mm, settlement reduction ratio increases by 55%, while installing 1 pile to 4 piles underneath the raft).

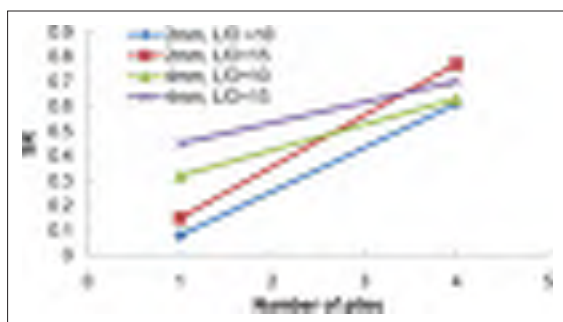


Figure 9 Variation of settlement reduction ratio with number of piles

## 4 Conclusion

The paper has presented experimental results of load tests on model unpiled raft, pile group, and piled raft embedded in soft clays. The research work focuses on the load-settlement behaviour of pile and raft. From the result of this study following conclusion can be drawn:

- Increase in raft thickness shows higher increment in the load carrying capacity of unpiled raft for large settlement compared to small settlement.
- Increasing the number of piles definitely increases the bearing capacity of pile-raft but increasing the length of pile increases the load carrying capacity more effective for smaller settlement.
- In case of integrated pile-raft system the load carrying capacity of pile-raft increases with increase in number of settlement reducing pile and length of pile.
- The pile-raft system is more effective for higher settlement as adding 4 piles improves the bearing capacity by 3-4 times.
- At 10 mm and 25 mm settlements, L/R, load improvement ratio increases as number of piles increases.
- Its also observed that as the number of piles increases the load shared by raft reduces and load shared by pile increases.
- The rate of increase of settlement reduction ratio decreases as the thickness of raft increases.

## Acknowledgement

The experimental works described in this paper are part of P.G. work of the second author. The test facilities provided by Applied Mechanics Department at L. D. College of Engineering, Ahmedabad, India to carry out this work are gratefully acknowledged.

## References

- [1] Bajad, S.P., et al.: "Pile-raft interaction in piled raft foundation on soft clay." IGC, Bangalore, 2008.
- [2] Bajad, S.P., Sahu, R.B.: "Optimum design of piled raft in soft clay—a model study." IGC, Guntur, 2009.
- [3] Lee, L., et al.: "Analysis of load sharing behaviour for piled rafts using normalized load response model." *Computers and Geotechnics*, Vol. 57, pp. 65-74, 2014.
- [4] El-Garhy, B., et al.: "Behaviour of raft on settlement reducing piles: experimental model study." *Journal of Rock Mechanics and Geotechnical Engineering*, Vol. 5, pp. 389-399, 2013.

- [5] Patil, J. D., et al.: "An experimental investigation on behaviour of piled raft foundation." International Journal of Geomatics and Geosciences, Vol. 5, No., 2, 2014.
- [6] Gopinath, B., et al.: "Numerical modelling of piled raft foundation in soft clays." Indian Geotechnical Conference, Mumbai, 2010.
- [7] Nguyen, D., Kim, S.: "Design method of piled-raft foundations under vertical load considering interaction effects." Computers and Geotechnics, Vol. 47, pp. 16-27, 2013.
- [8] Alkinani, A., Reddy E.S.: "Design of the Piled Raft Foundations for Load Settlement Behavior using a Multiphase Model", International Journal of Scientific Engineering and Technology Research, Vol. 6, Issue. 24, pp. 4766-4776, Septmber 2014.
- [9] Arora, K.R.: "Soil Mechanics and Foundation engineering." Standard Publishers Distributor, Delhi, 881p, 1987.
- [10] IS: 1904-1986: "Code of practice for design and construction of foundations in soils: general requirements."
- [11] IS: 6403-1981: "Code of practice for determination of breaking capacity of shallow foundations."
- [12] IS: 2911 (Part 1/Sec)-2010: "Design and construction of pile foundations-code of practice."
- [13] IS: 2911 (Part 4)-1985: "Code of practice for design and construction of pile foundations."
- [14] IS: 2950 (Part 1)-1981: "Code of practice for design and construction of raft foundations."



## OPERATIONAL PLAN FOR CONSTRUCTION OF RAILWAY LINE BELGRADE – NIŠ ON SECTION STALAČ – ĐUNIS

Tatjana Simić, Tatjana Mikić, Tomislav Milićević  
CeS COWI d.o.o., Serbia

### Abstract

The Serbian Railways network consists of state, regional and local rail lines which form part of the Pan-European corridors – lines of international importance connecting Serbia with neighbouring countries. Priority of developing Serbian Railway Network are pointed to integration of the most important international main railways through Serbia and the Pan-European network providing interoperability railway with high performance standards and increasing service quality on other railways on the network (higher speeds, greater bearing capacity, greater transport capacity, greater security, electrification, etc.). In the Spatial Plan of the Republic of Serbia, the first strategic priority is development of Corridor X; an important part of this corridor is the section Stalač – Đunis on the railway line Belgrade – Nis, which is the subject of this title. Operational Plan during construction contains descriptions of main works on the construction this section as first input for the Final Beneficiary in decision-making process for the next steps. Organization of construction for of this phase of the project documentation – Preliminary Design for the aim has to make a proposal of necessary time for separately building in accordance with the schedule of the total time that was developed during the design. Complexity of the route with a large number of structures 5 tunnels and 5 bridges, more overpasses/underpasses, inaccessibility approach, the reconstruction of two stations with accompanying railway infrastructure were a major challenge for the preparation of the organization plan for construction works

*Keywords: Railway constructing, civil works, systems, operational plan*

### 1 Introduction

Having in mind that the focus of the National Programme of the Republic of Serbia focused on the completion, modernization and sustainable development of the Serbian Railways and inland waterways transport system within the Pan-European Corridors X and VII to the required capacity levels and quality standards relevant to the TEN-T network, financial assistance for realisation of the National Programmes has been provided through the Instrument for Pre-Accession Assistance (IPA) by the Government of Serbia.

In the Spatial Plan of the Republic of Serbia, the first strategic priority is development of Corridor X. An important part of this corridor is the section Stalač – Đunis on the railway line Belgrade – Niš. The existing Stalač – Đunis section on the railway line Belgrade – Niš is 18.7 km long and is a priority for reconstruction and modernisation, because this is only single-track section on the railway line between Belgrade and Niš. This section currently follows the narrowed and winding valley of the Južna Morava River through an area with numerous unstable spots, landslides, and landfalls of riverbanks.

The main issue on the section Stalač – Đunis is the lack of reliability (and potential) delays caused by the single track section. The backlog of maintenance (ordinary and periodic) has



produced a constant trend of deterioration of the rail network. In order to alleviate this trend and keep the rail infrastructure operating, speed restrictions (permanent and temporary) are imposed. The design speed is no longer achieved. In general, main lines are designed for a maximum speed of 120 km/h. However, the present permissible train speeds are far below the design speeds on most lines and line sections.

The main objective of the Serbian railway transport system within the Pan-European Corridor X railway is to achieve a much higher quality in order to meet the actual needs of a modern transportation market. Only if this is achieved will the number of transported passengers and the amount of freight transport return to levels significantly greater than the current ones.

The Preliminary Design on the section Stalac – Đunis includes the provision of Preliminary Design with Feasibility Study, Environmental Impact Assessment and Expropriation Plan for:

- Reconstruction of the existing track and construction of a second track (subject to existing topography meeting track design requirements for 160 km/h);
- Overhead contact line (catenary),
- Signalling-safety and telecommunications installations;
- Construction and reconstruction of structures: tunnels, bridges and viaducts;
- Railway stations and stops; and
- Removal of level crossings.

## 2 Overview the scope of work in the project

### 2.1 Alignment

Currently there are six official points on the section of Stalać to Đunis: Stalać station at km 176 + 311, the Stevanac passing loop at km 181 + 880, Braljina station at km 186 + 487, Cero-vo Razanj halt at km 190 + 300, the Staro Trubarevo passing loop at km 192 + 216 and Đunis station at km 194 + 940. The new railway line will keep only the stations at Stalać and Đunis. The existing geometry and the curve radius could not satisfy the requirement for the design speed of 160 km/h (min R = 1500 m).

For this reason a completely new alignment is designed, with min R = 1500 m, max longitudinal grade 12.5‰ and, due to a heavy terrain conditions, 5 new tunnels along the new railway alignment. The newly designed alignment has cca 17.7 km of reconstructed or completely new railway. Between the station of Stalać and Đunis the existing distance is 18.7 km and the new distance is 16 km.

On the designed railway line from Stalać to Đunis, there are 5 tunnels, two underpasses, 7 bridges (1 over the river South Morava), 1 viaduct, and several culverts. The total length of railway line in the tunnel is 6.9 km which is about 40% of the reconstructed line.

The Figure 1 shows the existing alignment – grey colour and the new alignment – red colour on the section Stalać-Đunis.

Stalać station is an intermediate station on the railway line and currently has 8 tracks and one safety track. The station has an industrial track that, along with the reconstruction of a certain length, will be kept. At the station, currently, there are two platforms and a pedestrian underpass to access the platforms. The station is also a terminus for the railway branch line Stalać-Kraljevo and, as such, will retain this function after reconstruction. The designed layout has also eight tracks, with three platforms and one pedestrian underpass to access the passenger platforms in order to avoid crossing the tracks at grade. Platforms are 400 m in length (two) and one with length of 220 m. Switches on main passing tracks and overtaking tracks are designed with R300 and on the other tracks R200 switches are designed. Rails on the main passing tracks and overtaking tracks are type 60E1, and the other tracks have rail type 49E1, mounted on reinforced concrete sleepers with elastic fastenings, both on tracks and switches.



**Figure 1** Overview map – existing and new alignment on the section Stalač-Đunis

Đunis station currently represents the changeover from a single-track to a double track railway. Currently the station consists of 5 tracks and 2 low platforms. Reconstruction provides a layout plan with 5 tracks as well. The designed layout is slightly translated towards Niš, because of the complex layout geometry in front of the station (S curve with transition curves). Also, two new platforms, placed between the main passing tracks and the overtaking tracks with a height of 55 cm from the top of the rail, are designed at the station. The length of the platforms is 220 m. The useful length of the tracks is 753 m (direction towards Niš) and 667 m (direction towards Stalač). At the entrance/exit of the station “A-V” track connections are designed with switches R500. Switches on the main passing tracks are designed with R300, and on the other tracks with R200. The type of rails on the main passing and overtaking tracks is 60E1, and on the other tracks 49 E1, they are placed on reinforced concrete sleepers with elastic rail fastening, for tracks and switches.

## 2.2 Structures

After station Stalač railway line is founded on the embankment and follows the bed of the river South Morava. The track on the open line is with rails type 60E1 on reinforced concrete sleepers with elastic rail fastenings.

All crossings with roads are designed separate grade – underpasses. According to that abolition of the existing level crossing after station Stalač is planned. Due to unfavourable terrain conditions, deviation of the local road that leads to the state road IIb 23 is designed with a new underpass at km 177+594 and connection to the main street in Stalač. In order to approach the emergency vehicles and possible evacuation from the tunnel 1 (1.45 km tunnel length) on the left side of the railway road is designed width of 3.5 m with the turn out for emergency vehicles. On the right side of the railway road width 3.5 m is designed as access to the evacuation plateau from the tunnel. At place of the tunnel 4 entrance (L = 3275 m) approaches are designed, and at the exit from the tunnel 5 there are also approaches designed, which will serve as the access for emergency vehicle in case of possible accidents.

Designed railway is, from km 178+895 (tunnel 1 entrance) up to the exit from the last tunnel 5, km 186+670, mostly in tunnels or on structures (bridges, viaducts, galleries). After the exit from the tunnel 5, the railway is on viaduct with a length of 300 m, from where it is designed on a high embankment all away to the entrance to the station Đunis.

In front of the station Đunis, near the bridge over the Ribarska river, existing railway line intersects with the state road IIa order, with separate grade underpass. After testing several solutions that would include a new underpass, designers came to the conclusion that, due to the proximity of the riverbed and flood level, the optimal variant would be overpass along with the state road deviation.

**Table 1** The list of structures

STRUCTURE	CHAINAGE	NOTE
beginning of the section which is subject of design	174+200.00	
existing overpass of state road	175+409.66	Existing
culvert	174+478.13	2,0 x 2,00
culvert	174+970.47	6,0 x 3,00
culvert	175+269.54	2.0 x 2,00
pedestrian underpass	176+324.51	Stalać station
bridge	176+620.68	over stream
retaining wall – beginning	177+079.33	<b>retaining wall on the left side of the track</b>
retaining wall – end	177+190	
underpass	177+593.80	span 10 m
culvert	177+377.22	2,0 x 2,00
culvert	177+465.30	2,0 x 2,00
culvert	177+785.33	2,0 x 2,00
culvert	177+988.90	2,0 x 2,00
culvert	178+339.77	2,0 x 2,00
culvert	178+512.98	3,0 x 2,50
culvert	178+719.78	2,0 x 2,50
TUNNEL 1 – ENTRANCE	178+895	<b>TUNNEL 1, L=1450 m</b>
TUNNEL 1 – EXIT	180+345	
bridge	<b>180+435.65</b>	<b>L= 90m</b>
bridge		
culvert	180+687.56	2,0 x 2,50
TUNNEL 2 – ENTRANCE	180+700	<b>TUNNEL 2, L=690 m</b>
TUNNEL 2 – EXIT	181+390	
bridge River Južna Morava,	181+554.80	L=298m
TUNNEL 3- ENTRANCE	181+725	<b>TUNNEL 3, L=435 m</b>
TUNNEL 3 – EXIT	182+160	
bridge over stream Gorčilovac	182+200.18	L=34m
TUNNEL 4 – ENTRANCE	182+325	<b>TUNNEL 4, L=3275 m</b>
TUNNEL 4 – EXIT	185+600	
gallery	185+615	
TUNNEL 5 – ENTRANCE	185+630	<b>TUNNEL 5, L=1040 m</b>
TUNNEL 5 – EXIT	186+670	
viaduct	186+850.38	L=290m
Culvert Livadski stream	187+113.10	3,0 x 2,50
bridge Trubarevački stream	187+520.46	L=15,0m
Bridge Zmijarnik stream	187+657.65	Zmijarnik stream, L=10 m
underpass	188+342.27	L=10m
Overpass state road IIA order	189+098.40	state road
bridge river Ribarska	189+190.47	L=50 m
culvert	189+330	pipe
footbridge	190+076.10	Đunis station
culvert	190+562.22	pipe
culvert	191+446.95	pipe
<b>end of the section which is subject of design</b>	<b>191+937.96</b>	

## 2.3 Roads

In order to maximize the safety of rail and road traffic relocation of existing roads is planned. All railway crossings with road traffic are designed to be grade separated. After examining the boundaries of cadastral municipalities along the respective section of the railway line, it has been found that the above mentioned intersections and deviations are within the cadastral municipalities that belong to the municipality Čičevac, except for the crossing at km 188 + 342.27 (existing chainge), which belongs to the municipality of Krusevac.

## 2.4 OCL/Substation

The configuration of the station tracks is changed in Stalać station so that all the catenary wire has to be dismantled, while in Đunis station two existing portals are kept and all other equipment of catenary wire has to be dismantled. Except for the first 2 km after Stalać, the new alignment of two-track rail from Stalać to Đunis is completely separate from the existing alignment of one-track rail with geometry that allows maximum speed to 160 km/h with minimal radius 1500 m and cant of 110 mm. This open part of rail is 11,588 km long, with 5 tunnels that are 6,890 km long – tunnel 4 is the longest tunnel, 3,275 km long. Part of the catenary wire on the open track from km 174+170 till existing insulated overlap at Stalać station is dismantled. The same occurs for the catenary wire of open track from the insulated switch at Đunis station till km 191+938. Thus, the scope of the Design is new catenary wire with construction for maximum rail speed to 160 km/h between Stalać and Đunis stations. The technical solutions of the catenary wire are standard solutions for speeds to 160 km/h, which is used on rails of Serbian Railway company according to General Design of catenary wire and Equipment specification catalogue CW. On the open part of the rail line, standard catenary wire is used with maximum spans of 70 m, maximum length of tensile sections 1600 m with the fixed point approximately in the middle of the span section. The system height is 1400 mm with mutual straining of the contact wire and the support cable above with an automatic straining device with ratio 1/4. In tunnels although a standard solution of catenary wire is used, reduced values are applied because of the limited space, so maximum distance of the span is 50 m and the system height is reduced to 1000 mm. The contact wire and support cable are strained separately on the tunnel wall, and the fixed point is derived as a fixed point at the portals.

Substation Đunis – The overhead contact line (OCL) between Sectioning Switchgear with Neutral Section (SSNS) Grejač and SSNS Sikirica is supplied by the Substation (SS) at Đunis. These switchgears (SWG) are remote controlled by remote control centre (RCC) Niš. SS Đunis is connected to 110kV grid through two 110kV overhead lines (OHL). Each OHL is with three phases. 110kV SWG is outdoor air isolated type (AIS). 25kV SWG is AIS indoor type. In the substation building the following equipment is located: 25kV SWG and equipment for control, protection, metering and auxiliary supply. The new traffic line No.5 in Đunis station is located in the area of the Đunis SS. This is the reason that the existing building in Đunis SS should be dismantled and a new one should be built. The location of the new building is on the right side of the existing SS Đunis SS, as is shown on the Layout dwg.

## 2.5 Signalling and safety installations and devices

As an overlay of the conventional signalling/interlocking system, an ETCS Level 1 system with infill function shall be installed to increase the capacity and reduce headways on the section. This will comprise of fixed and switchable eurobalises and euroloops on the station tracks with platforms (for wrong way train running, e.g. in case of down train on the up line block section with the same block length for both ways). In the neighbouring stations with relay interlocking devices Siemens SpDrS-64 (Cicevac, Korman), appropriate interfaces shall be installed to retain the function of distributed relay automatic line block. On sections Cicevac-Stalać and

Đunis-Korman all existing level crossing interlocking devices shall be modified concerning activation sections, according to the new regulations in force. During the construction phase, a temporary interlocking shall be installed in stations to enable signalled traffic operation (without the possibility of automatically setting the point machines), by using the relocated existing signalling cables for connection of field elements. Existing level crossing interlocking devices on section Stalać-Đunis (one), as well as level crossing interlocking devices on adjacent sections Cicevac-Stalać (two) and Đunis-Korman (six), will remain in automatic operation mode until the interlocking devices in Stalać and Đunis stations are switched-off. After that, during the remaining construction period, railway traffic over these level crossings will be conducted according to the procedure defined in Traffic Rulebook /Rulebook 2/- the train must slow down and stop in front of each level crossing, with audible warning to the road drivers.

## 2.6 Telecommunication installations and devices

Along the new alignment, the following telecommunication systems shall be installed:

- Lineside railway copper cable
- Lineside railway optical cables (2 redundant cables, one on each side of the alignment)
- Cable ducts
- SDH-based transmission system (STM-16 rate)
- Railway dispatching system
- Local telephone network in stations
- GSM-R network with temporary centre (OMC) in Stalać station, base stations along the alignment located about 7 km each and repeating base stations on entry/exit of the tunnels together with radiating cable inside
- Analogue 460MHz band radio-system, for trains not equipped with GSM-R in this phase
- Station telecommunication systems (structural IP network, passenger information system, announcement (sounding) system, video surveillance system, fire detection system, master clock system)
- Telecommunication systems in tunnels

Protection and relocation of the affected existing telecommunication installations is predicted according to the conditions issued by telecommunication authorities in charge: “Telekom Serbia”, “Emisiona Tehnika” and “Ratel”, as well as other involved vendors of the telecommunication services (cable operators SBB and VIP). In the received technical conditions, a corridor of the existing telecommunication lines is shown, and in cases that there are interferences with installations along the new track alignment, corresponding technical measures for mounting of new installations are prescribed together with protective measures for performing works in the vicinity of existing installations (for example manual trench excavation, minimum horizontal and vertical distances from existing installations etc).

## 3 Operational plan during construction

Operational Plan during construction contains:

- Organization of railway traffic during construction
- Organization of Construction works

Proposal of organization of traffic during the construction works and estimation of total duration of construction of new double track railway section Stalać – Đunis it will be first input for the Final Beneficiary in decision-making process for the next steps.

Study on Organization of construction for this phase of the project documentation – Preliminary Design will give an overview of the time required for construction in accordance with the time schedule that the Consultant developed during the design.

In the next phase of preparation of project documentation, which will provide a greater level of details and proposals of construction technology based on previous inputs, the Beneficiary will have a comprehensive view on the subject of construction works methodology for the selection of the Contractor.

### 3.1 Organization of railway traffic during construction – as note

The intersections between the existing railway line and the newly designed one are primarily at the railway stations Stalač and Đunis, but at 4 spots on the open line (at km 177+325, km 178+642, km 181+421 and km 187+290).

To determine the principles of the organization of railway traffic during construction, a traffic plan will be used on the basis of the Timetable 2014/15. The analysis includes the existing volume of traffic and the existing capacity in the stations, and the phases of the works that will provide a minimum of disruption to railway traffic. Times in the timetable, which can be used for construction works, are limited by planned train-paths of international passenger trains. Rail closures should be introduced taking into account the international passenger trains as well as future international freight trains, as much as possible. Buses can be used as replacements for domestic passenger traffic, in periods of railway traffic closure. Domestic freight traffic should to be planned in the free intervals (at night, for example).

Serbian Railways will determine and make a final decision on the way of the organization of railway transport during the works, and the documentation from this project aims to present the potential issues and help in future decision-making. Detailed conditions and timelines with the costs will be determined in the future design phases.

Civil and structural engineering construction works are the most time consuming. All other works relating to the installation of signalling & interlocking devices, telecommunication devices, as well as electrical works on the catenary, will be defined by phases, the same ones as for the construction works, and must be fitted into the planned duration of each construction phase. Before the start of construction work, it is necessary to protect telecommunication cables along the railway line in order to avoid damages. Some of the existing cables will be used in the inception phase of construction until all of the existing interlocking and telecommunication devices will be dismantled. In the event of cable disruption, the Traffic Rule Book determines the procedures, according to a potential hazardous situation. Railway traffic will be performed in interstation distance mode, according to applicable regulations. Handling of switches will be performed manually in the stations. It is necessary to plan for an increased number of staff, which is particularly related to the required number of switchmen. During the works, it is necessary to determine speed limits as follows:

- On interstation distance mode, where works are performed – it is necessary to reduce the speed of trains to 50 km/h,
- In sub-sections adjacent to the zone of the works, it is necessary to limit the speed to 20 km/h,
- Speed Reductions will have an adverse effect on the line capacity, but not significantly, because the existing speed on this section is 85 km/h or 65 km/h, and during the works it will be reduced to 50 km/h, except in sub-sections adjacent to work sites, where it will be 20 km/h. The decrease of the line capacity will be caused by the regulation of traffic in the interstation distance mode.

In the stations, the purpose of the station tracks will be changed, in relation to the station Rulebook. In accordance with the provisions of the Traffic Regulations, it is necessary to plan the works in advance to allow time to make a temporary timetable and deliver it in a timely manner to interested staff (station staff, staff on the open line and driving personal). Driving personnel have to be informed about all changes in the timetable. Notification of personnel is performed at terminus or dispatching stations, according to current regulations.

During the works, for the needs of transport of the material and disposal of the old material, works trains should be planned, whose routing must be provided in the Guidance on the Organization and performing of traffic services during the works that need to be prepared by Serbian Railways.

### **Organization of Construction works**

New double-track railway line section between Stalać and Đunis is designed in its greatest part on structures and in tunnels (to adhere to the requirements of the Terms of Reference and the terrain topography). Length time for construction work depends on the time for the construction on tunnels and structures. Works on the superstructure will follow dynamic of construction works on the tunnels and structures. Total time duration on the one group of construction work consists of individual time for:

- Preparatory works
- Main works
- Finishing works

The construction of the following sections will be done without interference to the traffic on the existing railway line:

- km 175+450 – km 175+535,
- km 177+000 – km 177+200,
- km 177+300 – km 178+550,
- km 178+700 – km 187+200,
- km 187+400 – km 189+350,

The proposed PHASES of construction works are shown below:

**PHASE 1** – For the purpose of the start of work on the bridge at km 181+556, suspension of traffic is necessary for the alteration of the entrance to Stevanac passing loop. Rail closures can be planned for 8 hours for construction works and alterations to the overhead contact line.

**PHASE 2** – During Phase of Stalać station reconstruction, tracks 5, 6, 7 and 8 are reconstructed first. Traffic is carried out over tracks 1, 2, 3 and 4. During Phase 1 in Đunis station, tracks 4. and 5. are under construction with a temporary connection to the existing track No. 4 at the station entrance, as well as a temporary connection of new track 4 to the existing right track on station exit. Traffic is carried out tracks 1, 2 and 3.

**PHASE 3** – During Phase of Stalać station reconstruction, tracks 1, 2, 3 and 4 are reconstructed. Traffic is carried out over tracks 5, 6, 7 and 8. During Phase 2 in Đunis station, tracks 1, 2 and 3 are under construction, as well as part of the new railway alignment from km 190+900 up to km 191+200. Traffic is carried out on tracks 4 and 5.

**PHASE 4** – Connection of the main tracks from Stalać station entrance to the existing railway tracks. Connection of the main tracks from Stalać station exit to the tracks on the new railway alignment. Temporary connection of a new left track with the existing railway track at km 177+235. For the purpose of the construction works closure of railway traffic is required. After completing the works railway traffic is carried out on the new alignment up to km 177+235, and then along the existing track. Connection of the new main tracks in Đunis station with the new designed part of double track alignment at the entrance and exit, together with the connection to the existing alignment towards Niš. Temporary connection of the new left track on the existing railway line at km 187+300. For the purpose of construction total closure of traffic is required. After the completion of the intervention traffic is carried on the new left track and on the existing single-track railway line (km 177+235 to 187+300).



**PHASE 5** – Connection of a new alignment at km 177+235, km 178+643 and km 187+290. During the construction works traffic is carried out on the new left track and on the existing track (km 177+235-187+300).

**PHASE 6** – Abolition of temporary track connections. Traffic is carried out on the right track of a new alignment.

End of the construction works. Removal of existing tracks and the construction of access roads along the old railway alignment. Establishing of a regular traffic timetable.

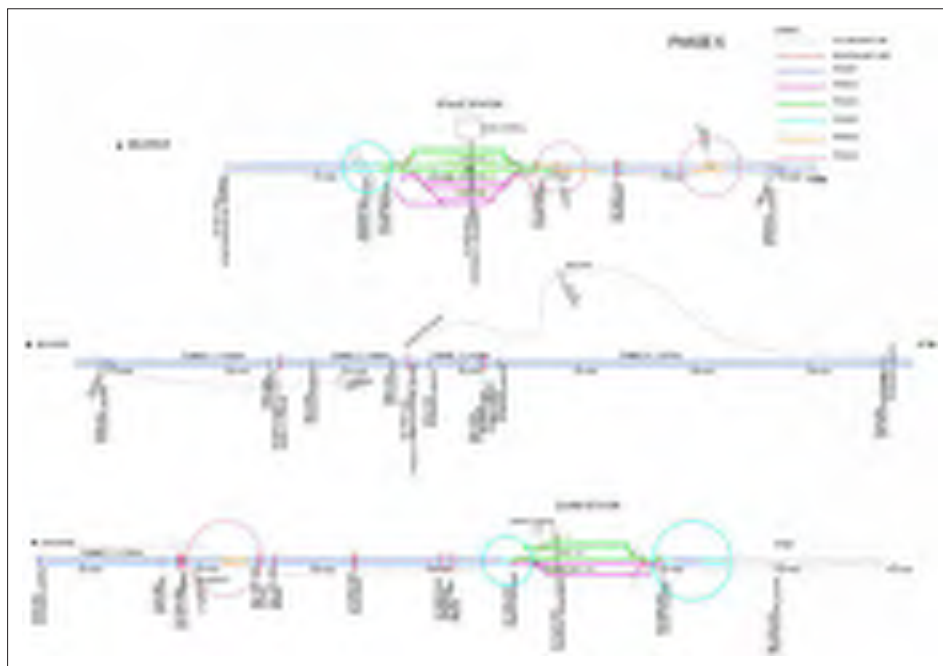


Figure 2 Six phases during the construction works

## 4 Conclusion

The complexity and the multidisciplinary phases of the project and its preparation for the construction represent a challenge for the selected Constructor. Developing of operational plan and consultant's vision of construction works are one of the proposal which gives approximately time and estimate cost for construction. The fulfillment of the three basic objectives: dates, quality and price, when deciding about selection of contractors, largely depend on the technology and organization of construction which will be offered.

Having that in mind, the proposal and consideration of construction feasibility represent good input data in preparing this project to become a real world railway line facility.



## References

- [1] The European Agreement on Main International Railway Lines (AGS), European Agreement on Important International Combined Transport Lines and Related Installations (AGTC), the South East European Co-operation Process (SEEC) and the European Technical Specification for Interoperability (TSI)
- [2] Law on Railways ("Official Gazette of RS", No 45/2013)
- [3] Law on Safety and interoperability of railways ("Official Gazette of RS", No.104 / 2013)
- [4] Rulebook on the Designing, Reconstruction and Construction of certain elements of the Railway Infrastructure of some main Railway lines ("Off. Gazette of RS", No.100 / 2012)
- [5] Law on Planning and Construction; Official Gazette of Serbia
- [6] Other technical regulations and standards for preparation of the project documentation for Reconstruction and Modernization of the Existing Railway Track and Construction of a Second Track on the Line Beograd–Niš, Section Stalać – Đunis



## TRANSPORT NETWORK DEVELOPMENT IN SOUTH-EAST EUROPE

Oliver Kumrić, Domagoj Šimunović, Goran Puž  
*Institut IGH d.d., Croatia*

### Abstract

Trans-European Transport Network (TEN-T) is a planned set of road, rail, air and water transport networks in the European Union, including multimodal transport. Relevant legal acts define transport corridors, main seaports, river ports and airports together with principal EU border crossings in order to improve internal connectivity and connections to neighbouring countries, as well as to set the foundation for the enlargement of the Union to the Western Balkans countries. The official extension of the TEN-T was intensively prepared during years 2014 and 2015: the network should extend to Albania, Bosnia and Herzegovina, Montenegro, Kosovo, Macedonia and Serbia. The announcement of the expansion contributes to the available financing opportunities, mainly to the possibility of co-financing projects from EU funds and international financial institutions. It is expected that investments in traffic infrastructure are to be intensified, primarily in the road sector, in motorways and expressways, while railways are to follow. This development will have an impact on traffic flows in Croatia since the main corridors in Western Balkan countries continue or supplement the corridors in our country, so it is the right time to re-examine the Croatian strategic spatial and traffic documents and to adapt them to the anticipated new circumstances. Another reason for the interest in capital infrastructure projects in neighbouring countries is the opportunity for Croatian consultants, designers and builders to capitalize their experience and references acquired through the years of intensive motorway construction on domestic market. Paper presents an overview of trends in neighbouring countries which are about to enter a comprehensive and core TEN-T network, as well as the review of the options for co-financing through European funds.

*Keywords: TEN-T, transport network, transport corridors, financing, infrastructure*

### 1 Introduction

Investing into transport infrastructure in Croatia, during the programme period 2014-2020, is focused on infrastructure required for modern, competitive and interconnected European economy that will facilitate flow of people and goods not only in Croatia, but towards other parts of Europe as well. According to the national Operational Programme Competitiveness and Cohesion, for the period 2014. – 2020. (OPCC), the investments in the Republic of Croatia will also focus on improving accessibility of towns and isolated areas and on enhancing territorial cohesion [1]. Integration of Croatian transport network into European transport network and enhanced regional connections should promote the development of national economy, improve passenger and freight traffic as well as traffic safety and decrease adverse environmental impacts.

On the other hand, improving connectivity within the Western Balkans, as well as between the Western Balkans and the European Union, is a key factor for growth and jobs and will bring clear benefits for the region's economies and citizens. The Western Balkans Six (WB6)

– Albania, Bosnia and Herzegovina, the former Yugoslav Republic of Macedonia, Kosovo, Montenegro and Serbia, has made the connectivity agenda one of its highest priorities, with a special emphasis on the preparation and financing of regional infrastructure investment projects, but also on the implementation of technical standards and soft measures such as aligning/simplifying border crossing procedures, railway reforms, information systems, road safety and maintenance schemes [2]. The European Commission will, via the Western Balkans Investment Framework (WBIF), co-finance mature transport projects from the TEN-T (Trans-European Transport) Core Network, together with loans from the international financial institutions.

## 2 Extending the Trans-European Transport Network (TEN-t)

The TEN-T guidelines for the development of the trans-European transport network are defined by the European Parliament Regulation 1315/2013 [8]. The network has two layers: the “core network”, which carries the most important passenger and goods flows; and the “comprehensive network”, which ensures access to the core network. Regulation 1315 contains maps with networks of infrastructure for railway transport, inland waterway transport, road transport, maritime transport, air transport and multimodal transport, both for EU member states and indicative extension to neighbouring countries.



**Figure 1** Trans-European Transport Network (TEN-t) – indicative extension to the Core Network Corridors [2]

Corridor approach is intended to be used as an instrument to coordinate different projects on a transnational basis. That instrument should not be understood as a basis for the prioritisation of certain projects on the core network. Core network corridors cover the most important long distance flows in the core network and are intended, in particular, to improve cross-border links within the Union. Core network corridors are to be focused on modal integration, interoperability, and a coordinated development of infrastructure, in particular in cross-border sections and bottlenecks.

In 2015, WB6 and EU officials tentatively identified three core network corridors to be extended for the Western Balkans as well as priority projects along sections of these corridors for possible EU funding over the next six years [2]. Extending the core network corridors to the Western Balkans should provide closer integration with the EU as well as the basis for leveraging investment in infrastructure, such as EU support through the Western Balkans Investment Framework and the Connecting Europe Facility.

The core network corridors, once completed, will provide quality transport services for citizens and businesses, with seamless integration within the region as well as with the EU. European Coordinators should facilitate the coordinated implementation of the core network corridors. Investments in infrastructure will be primarily financed from European Structural & Investment Funds (ESIF) and the funds available through Connecting Europe Facility (CEF).

Indicative extension of the Core Network Corridors in the Western Balkans, are shown in Figure 1, as presented in Connectivity Agenda in 2015 [2]. The Commission has adopted new maps of the extension of the trans-European transport network (TEN-T) to Iceland, Norway and the countries of the Western Balkans in February 2016. These indicative maps were prepared with the concerned countries and endorsed at the Western Balkans 6 Summit in Vienna on 27 August 2015.



**Figure 2** Trans-European Transport Network (TEN-t) map fragment, comprehensive & Core Network: Roads, ports, rail-road terminals and airports, comprehensive and core network [7]

From Croatian perspective, the most important feature of the map presented is anticipated extension of the Mediterranean Corridor, marked in green in Fig 1. The Mediterranean Corridor links the Iberian Peninsula with the Hungarian – Ukrainian border. Its extension into the Western Balkans connects Central Europe, specifically Hungary and eastern Croatia to Bosnia and Herzegovina and the Adriatic sea. New branch of Mediterranean Corridor can be recognized as Adriatic – Ionian Transport Corridor, which officially became the part of priority transport network.

For the Western Balkans region, these maps reflect an important agreement with the EU as regards the connectivity within the region and with the EU as a whole. This core network will provide a common reference for deploying and coordinating investments and traffic optimisation measures along strategic transport routes [7]. Possible EU funds that can be used in WB6 are Instruments for Pre-Accession Assistance (IPA), Connecting Europe Facility (CEF), macro regional programmes and The Western Balkans Investment Framework.

### 3 The Adriatic – Ionian Transport Corridor

The Adriatic-Ionian Transport Corridor (AITC) is historic traffic corridor, which stretches along the Adriatic and Ionian sea coast, parallel with the coastline. The corridor runs from Trieste to Kalamata thus linking seven countries: Italy, Slovenia, Croatia, Bosnia and Herzegovina, Montenegro, Albania and Greece as well as important Adriatic and Ionian ports.



**Figure 3** The Adriatic – Ionian Motorway alignment and main seaports along its route, with main transversal corridors towards regional capitals.

AITC involves complementary development of all traffic modes and infrastructures (road, rail, sea, air) and the elements of integrated transport system. However, the road system would initiate development processes and speed up other modes projects. For that reason, the Adriatic – Ionian motorway general alignment is presented in Figure 3 (total length approx. 1550 km). Considering the importance of this corridor for economic development of the Republic of Croatia the sections of some national motorway routes within the corridor have already been completed. Some other sections, which coincide with the future Adriatic-Ionian motorway, are scheduled for construction [3].

Most of the length of the Adriatic – Ionian motorway in Croatia coincides with the route of the most important (but not the busiest) Croatian motorway – A1. It connects two largest Croatian regions and two largest cities – Zagreb and Split, extending southwards towards Dubrovnik. In the future, remaining parts of the highway around the city of Rijeka are to be built, including the connection with the Slovenian transport network in the north. Another part of a new highway along the Adriatic corridor currently under consideration is southern section from the port of Ploče to Dubrovnik and further, to the border with Montenegro. It has not yet been defined whether a southern section of Adriatic motorway will pass through Croatian territory south of Ploče (as it is anticipated in national spatial plans) or through south-east Bosnia and Herzegovina near Trebinje (as it is proposed by some experts).

Future development of the projects aiming to improve the connections between countries sharing Adriatic and Ionian shores might be enhanced by the regional strategy. The European Council endorsed the European Union Strategy for the Adriatic and Ionian Region (EUSAIR) in September 2014. The Adriatic and Ionian Region is a functional area primarily defined by the Adriatic and Ionian Sea basin. EUSAIR is built on four thematic pillars, one of them being the “Connecting the Region” [6].

#### 4 Investments in WB6 transport infrastructure

According to SEETO (South-East Europe Transport Observatory) documents, total investments on the TEN-T Comprehensive Network to the Western Balkans in the time period from 2004 to 2015 amount to 12 billion Eur. Approximately half of this amount is already disbursed (projects are completed), while other half is committed (project under execution).

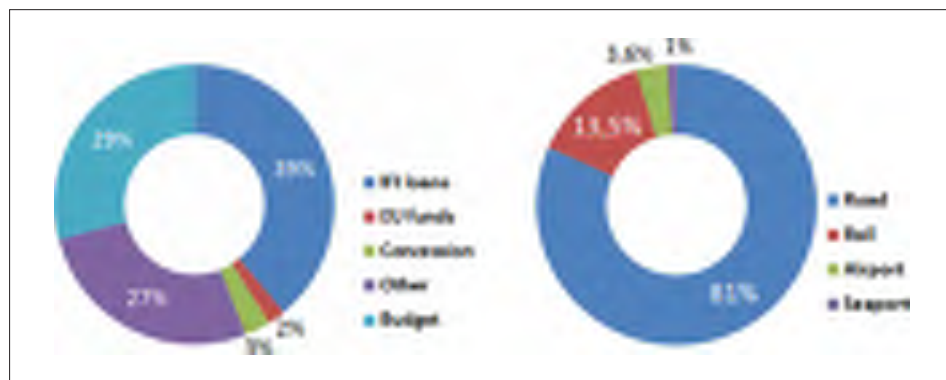


Figure 4 Investments in TEN-T Comprehensive network to the Western Balkans by source of funding (left) and by the transport mode (right).

Trend of high investment in road infrastructure in the Western Balkans is present continuously from 2004, while the trend of rather small investments in rail infrastructure projects is changing slowly [4]. Airport infrastructure, with 3,6% of total investments in the TEN-T Comprehensive Network investments holds the third place, after Road and Rail. The predominant



source of funding is through Concession Agreements. Transport modes with the lowest level of investments are Inland waterway infrastructure and Seaport infrastructure. When observing investments in TEN-T Comprehensive network to the Western Balkans by source of funding, the highest share (39%) is financed through IFI (international financial institutions) loans. EU funds share is expected to grow due to new connectivity agenda and the new IPA 2014-2020 fund, to app. 2%. Concession financing is focused on Airport infrastructure projects (app 3%). Other sources, with a share of 27%, consists mostly of China's Exim Bank, Russian Loans, Abu Dhabi fund, Kuwait Fund, OPEC are rising in the last years.

## 5 Programmes and plans in Croatia

Operational Programme Competitiveness and Cohesion (OPCC) defines planned activities which aim to increase territorial cohesion and connectivity to EU road network and eliminate bottlenecks in investment priority 7a – Supporting a multimodal Single European Transport Area by investing in the TEN-T. These activities aim to complete remaining missing links in the network and introduce environmental features where needed. Transport sector in the OPCC is designated as priority 7, Connectivity and Mobility, with the amount of HRK 9,9 billion from EU funds being allocated for the priority goals [1].

The OPCC was developed in accordance with draft National Transport Strategy – a document which determines a medium and long-term development by increasing the quality of transport system and the transport infrastructure in the Republic of Croatia (the Strategy) [5]. The general goal of the Strategy is to define measures which would lead to an efficient and sustainable transport system. The objectives of the Transport Development Strategy are improvements in following areas:

- connectivity and coordination with neighbouring countries
- passengers' long distance accessibility inside Croatia
- regional connectivity enhancing territorial cohesion
- accessibility to and within the main urban agglomerations
- freight accessibility inside Croatia
- Transport System Organisational and Operational setup.

In order to address the defined objectives, a set of measures has been identified in each transport sector: rail (42 measures), road (35 measures), aviation (27 measures), inland waterways (22 measures), maritime (32 measures), urban and regional (22 measures). Finally, document presents alternative groups of measures for each objective. It could be stated that the document fails in recognizing clear and achievable priorities, ending with complex matrix instead of clear statements.

## 6 Conclusion

It is clear that the projects which are expected to be implemented in the Republic of Croatia in the transport sector in the years to come need to be based on the National Transport Strategy and should follow the corridors defined by the TEN-T. The financial crisis which had a significant impact on Croatian economy and heavy debt accumulation in the years before the crisis are the key reasons for narrowing the possibility of financing infrastructure projects from the national budget. It is therefore expected that a great majority of investments in infrastructure will be primarily financed from European Structural & Investment Funds (ESIF) and the funds available through Connecting Europe Facility (CEF). Potential projects shall be coordinated with EU strategies aiming to improve the connections between neighbouring countries. Development of traffic infrastructure on main corridors in Western Balkan countries, which supplement corridors in Croatia, gives us the motive to encourage the cooperation between Croatia and WB6 in planning future traffic networks.

## References

- [1] Operational Programme Competitiveness and Cohesion 2014 – 2020, [http://www.strukturnifondovi.hr/UserDocsImages/Novosti/Programme\\_2014HR16M10P001\\_1\\_2\\_en.pdf](http://www.strukturnifondovi.hr/UserDocsImages/Novosti/Programme_2014HR16M10P001_1_2_en.pdf), 30.04.2016.
- [2] CONNECTIVITY AGENDA, Co-financing of Investment Projects in the Western Balkans in 2015, [http://ec.europa.eu/enlargement/pdf/policy-highlights/regional-cooperation/20150828\\_vienna\\_info\\_pack.pdf](http://ec.europa.eu/enlargement/pdf/policy-highlights/regional-cooperation/20150828_vienna_info_pack.pdf), 30.04.2016.
- [3] Radić, J., Puž, G., Marić, M.: The Adriatic – Ionian Transport Corridor, proc. IRF Europe & Central Asia Regional Congress, September 15-18, 2015 – Istanbul Turkey
- [4] SEETO: Multi-Annual Development Plan: Common problems – Shared solutions, Five Year Multi-Annual Plan 2016, [http://www.seetoint.org/wp-content/uploads/downloads/2016/01/SEETO\\_brosura\\_lowres.pdf](http://www.seetoint.org/wp-content/uploads/downloads/2016/01/SEETO_brosura_lowres.pdf), 05.04.2016.
- [5] Transport Development Strategy of the Republic of Croatia (2014 – 2030), October 2014, [http://www.mppi.hr/UserDocsImages/TR-DEVLP%20STRAT-M-DOC3010-14%20FINAL%2025-12\\_15.pdf](http://www.mppi.hr/UserDocsImages/TR-DEVLP%20STRAT-M-DOC3010-14%20FINAL%2025-12_15.pdf), 05.04.2016.
- [6] European Commission : For a Prosperous and Integrated Adriatic and Ionian Region, [http://ec.europa.eu/regional\\_policy/sources/cooperate/adriat\\_ionian/pdf/brochure\\_250914.pdf](http://ec.europa.eu/regional_policy/sources/cooperate/adriat_ionian/pdf/brochure_250914.pdf), 05.04.2016.
- [7] [http://ec.europa.eu/transport/themes/infrastructure/news/2016-02-04-ten-t-maps-neighbouring-countries\\_en.htm](http://ec.europa.eu/transport/themes/infrastructure/news/2016-02-04-ten-t-maps-neighbouring-countries_en.htm), 05.04.2016.
- [8] Regulation (EU) No 1315/2013 of the European Parliament and of the Council of 11 December 2013 on Union guidelines for the development of the trans-European transport network and repealing Decision No 661/2010/EU, <http://eur-lex.europa.eu/legal-content/HR/TXT/?uri=CELEX:32013R1315>
- [9] Regulation (EU) No 1316/2013 of the European Parliament and of the Council of 11 December 2013 establishing the Connecting Europe Facility, amending Regulation (EU) No 913/2010 and repealing Regulations (EC) No 680/2007 and (EC) No 67/2010 (1) <http://eur-lex.europa.eu/legal-content/HR/TXT/?uri=CELEX:32013R1315>







## ANALYSIS OF POSSIBILITIES TO INCREASE THE CAPACITY OF M202 ZAGREB-RIJEKA RAILWAY LINE ON SECTION OGULIN-ŠKRLJEVO

Maja Ahac<sup>1</sup>, Stjepan Lakušić<sup>1</sup>, Ivan Obad<sup>2</sup>, Katarina Vranešić<sup>3</sup>

<sup>1</sup> University of Zagreb, Faculty of Civil Engineering, Croatia

<sup>2</sup> Radius projekt d.o.o., Zagreb, Croatia

<sup>3</sup> Appellas Studio d.o.o., Zagreb, Croatia

### Abstract

The Port of Rijeka is the main Croatian port within the TEN-T network. This largest Croatian port and third largest city in Croatia, the city of Rijeka, are connected with the rest of Croatia and Europe by main railway line M202 Zagreb-Rijeka (part of the Mediterranean corridor RH2). The line capacity is limited to approximately five million tons per year. This is because of its poor technical and technological features which are mostly a direct consequence of rolling terrain of Rijeka hinterland from Ogulin to Škrljevo. From the Port of Rijeka development plans, whose implementation is under way, the importance of this railway line for freight traffic is expected to increase significantly. A number of solutions to increase the capacity of the railway section Ogulin-Škrljevo have been proposed during the last decades. However, they have not yet developed beyond the level of studies and preliminary designs.

This paper presents an overview and comparison of the technical and technological characteristics of the existing railway section and several proposed solutions to increase its capacity: complete reconstruction of single track line with the introduction of more favourable horizontal and vertical elements, construction of a new double track on the most critical track subsection, and track upgrade by construction of a second track with a partial reconstruction of the existing. The objective of this analysis is to determine the most economic development of analysed railway section, harmonized with the development of the Port of Rijeka and the Rijeka railway junction, as well as other parts of the Rijeka traffic route.

*Keywords: Port of Rijeka, railway line Ogulin-Škrljevo, freight capacity, reconstruction, upgrade, variant analysis*

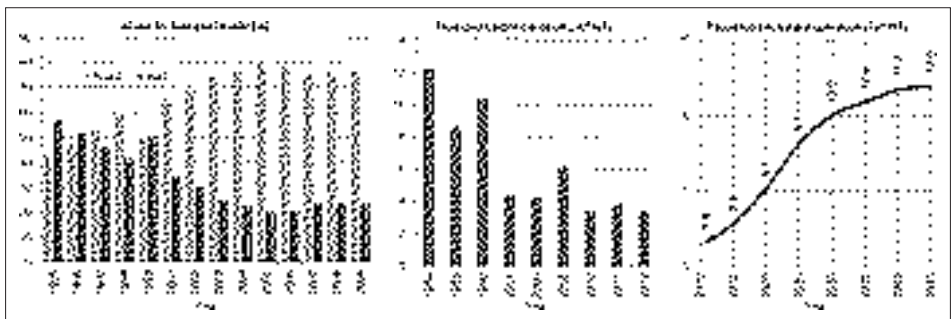
### 1 Introduction

The Port of Rijeka is the main Croatian port within the TEN-T network. This largest Croatian port and third largest city in Croatia, the city of Rijeka, are connected with the rest of Croatia and Europe by main railway line M202 Zagreb-Rijeka (part of the Mediterranean corridor RH2) [1]. The City of Rijeka is currently implementing Rijeka Gateway project or Rijeka traffic route redevelopment project. This is a complex development program which aims at redeveloping port/city interface in order to reconcile the port operation requirements and the city urban and public needs, and improving the port traffic connection with the international road and railway corridors [2].



**Figure 1** Main rail line M202 and Port of Rijeka Basin

The development and modernization of the Port is not accompanied by concurrent development of both road and railway infrastructure of Rijeka hinterland. This statement is best shown through the following historical data on the amount of freight rail transport. The share of railway cargo transport with the source and destination in the Port of Rijeka in the 1990's amounted to about 90%. However, construction of the new motorway diverted much of the cargo to the road transport. Today, the railway participates in delivery/dispatch of goods with approximately 20-25% (Figure 2, left) [3], and realized freight transport on rail section Ogulin-Rijeka has dropped to a third of the value achieved thirty years ago (Figure 2, middle) [4, 5, 6]. The Port of Rijeka development strategy is to increase the port present capacity of about 10 million tons of dry cargo to around 20 million tons by the year 2017. Together with planned liquid cargo, port capacity should amount to 45 million tons. Planned major investments in the Port development by 2030 should further increase its capacity to over 30 million tons of dry cargo, i.e. to a total of over 55 million tons. For the purpose of this analysis, it can be assumed that the cargo operations in Ports railway stations (Rijeka, Rijeka Brajdica, Bakar, Figure 1), will amount to 12 million tons by the year 2045 (Figure 2, right) [6].



**Figure 2** Left: share of land transport in container transshipment of the Port of Rijeka; Middle: realized freight transport on rail section Ogulin-Rijeka; Right: predicted rail freight transport on rail section Ogulin-Rijeka

The existing railway line servicing the Port does not have sufficient capacity to accept the above mentioned planned maximum traffic volume. The line was built in 1873 and its capa-

city is limited to technical and technological features characteristic of the time and rolling terrain of Rijeka hinterland: it is a single track line for mixed traffic with small curve radii and steep gradients, which in some parts are limiting train speed to 40 km/h. Line capacity is approximately five million tons per year, mostly because of the poor operation characteristics of section from stations Ogulin to Škrljevo [1]. Around 50 km long continuous maximum gradient from Rijeka (Škrljevo) toward inland makes this particular rail section one of the most challenging railway lines in operation in Europe [7].

The much needed increase of the capacity on this railway line is discussed basically from the day of its construction, but only in the last few years there is a serious trend of shifting the investment focus from road to railway sector in this area. It has carried out a number of activities including design, construction, reconstruction and modernization of the complete corridor RH2 (Figure 3).



**Figure 3** Activities on design of construction, reconstruction and modernization of the corridor RH2, State Border-Botovo-Zagreb-Rijeka [6]

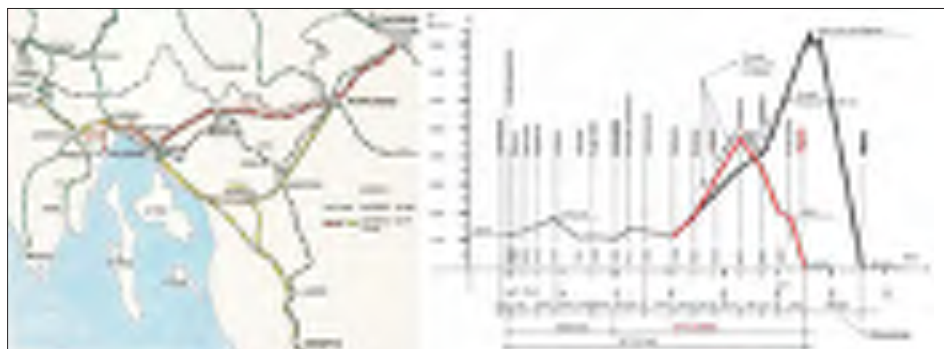
From Figure 3 it can be seen that the modernization of the railway line section Ogulin-Škrljevo is still in the research phase. To date, measures to increase the capacity of the said section are limited to periodic renewal of interstation sections, upgrade of the existing signalling system, and modernization of electric traction system. Possible design and construction solutions to increase the capacity of the railway section, whose first variants are more than 50 years old, can be divided into three basic groups:

- construction of new double track high performance line,
- reconstruction of single track line with the introduction of more favourable horizontal and vertical elements,
- upgrade by construction of a second track on most critical subsections together with a partial reconstruction of the existing track.

## 2 Characteristics of analysed variant solutions

For the purpose of this study the characteristics of the existing Ogulin-Škrljevo rail section and variants of its design betterment were discussed and mutually compared from the construction, transport and economic point of view. Variants observed were second track construction

and reconstruction of existing one, together with construction of new and reconstruction of existing stations in order to extend usable track length. Variant that proposes construction of new double track high performance line (Figure 4) is not considered in this study because its main goal was to determine the possibility of using the existing rail route and infrastructure to increase its capacity.



**Figure 4** Left: Kupa and Drežnica variants of the new two-track railway Zagreb-Rijeka; Right: Preliminary design for Drežnica variant of railway State Border-Botovo-Zagreb-Rijeka [3]

During the development and analysis of variant solutions, exclusively freight traffic was considered, since it is dominant on the observed railway line section. The reason for this is the highly developed motorway network and the existence of several international airports in this area. In other words, here the railway passenger transport system can hardly compete with other modes of transport. Also, geomorphological characteristics of Rijeka coast technically complicate and therefore make unprofitable the efforts to connect the northern Adriatic and inland by construction of modern high speed railway line for passenger traffic [8].

## 2.1 Design characteristics

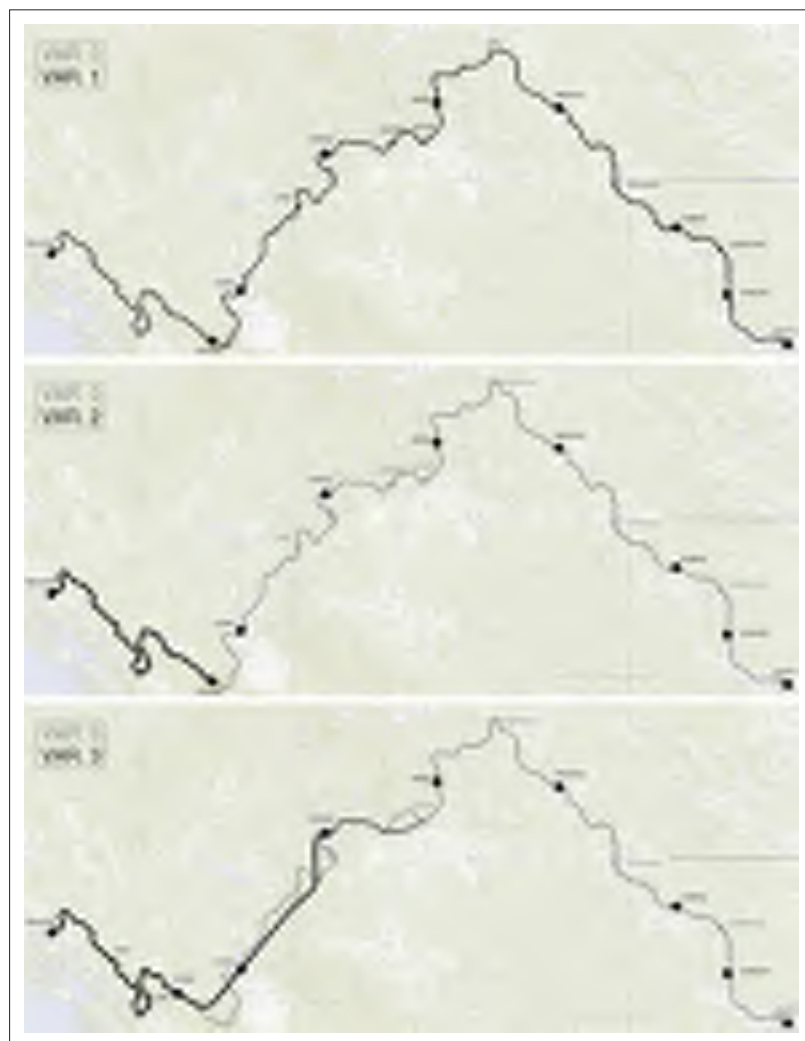
During the development and analysis of variant solutions the following nomenclature is used:

- VAR.0 represents a single existing rail track whose basic geometry parameters, given the rolling terrain and construction date, correspond to the former steam traction (large number of curves adapting the track route to hillsides and mountains, relatively low travelling speed, and high longitudinal gradients);
- VAR.1 represents a complete reconstruction of the existing single track rail line section Oguštin-Škrljevo in order to improve its geometry and thereby increase travel speed and freight capacity [9, 10];
- VAR.2 represents construction of second track with a complete reconstruction of the existing track section Drivenik-Škrljevo [9];
- VAR.3 represents route relocation and construction of a new single track section Kupjak-Delnice, construction of new double track Delnice-Zlobin, and second track construction with a partial reconstruction of the existing track (retaining the existing vertical alignment) on section Zlobin-Škrljevo [7].

Table 1 shows input parameters used for track variants horizontal and vertical alignment conceptual design (Figure 5 and 6) and their basic characteristics (track section length, number of stations and structure length).

**Table 1** Track variants design characteristics.

Variant	VAR.0	VAR.1 [9, 10]	VAR.2 [9]	VAR.3 [7]
Design speed [km/h]	75	100	75	75
Minimal horizontal curve radius [m]	250	500	250	250
Maximal gradient [‰]	27	25	25	27
Single track section length [km]	107.7	102.5	83.3	58.1
Double track section length [km]	0	0	23.5	39.6
Total route length [km]	107.7	102.5	106.8	98.5
Number of stations	21	13	15	15
Tunnels [km']	3.2	8.9	3.8	14.5
Bridges [km']	0.1	3.7	3.3	3.6



**Figure 5** Variants VAR.0-3 horizontal alignments

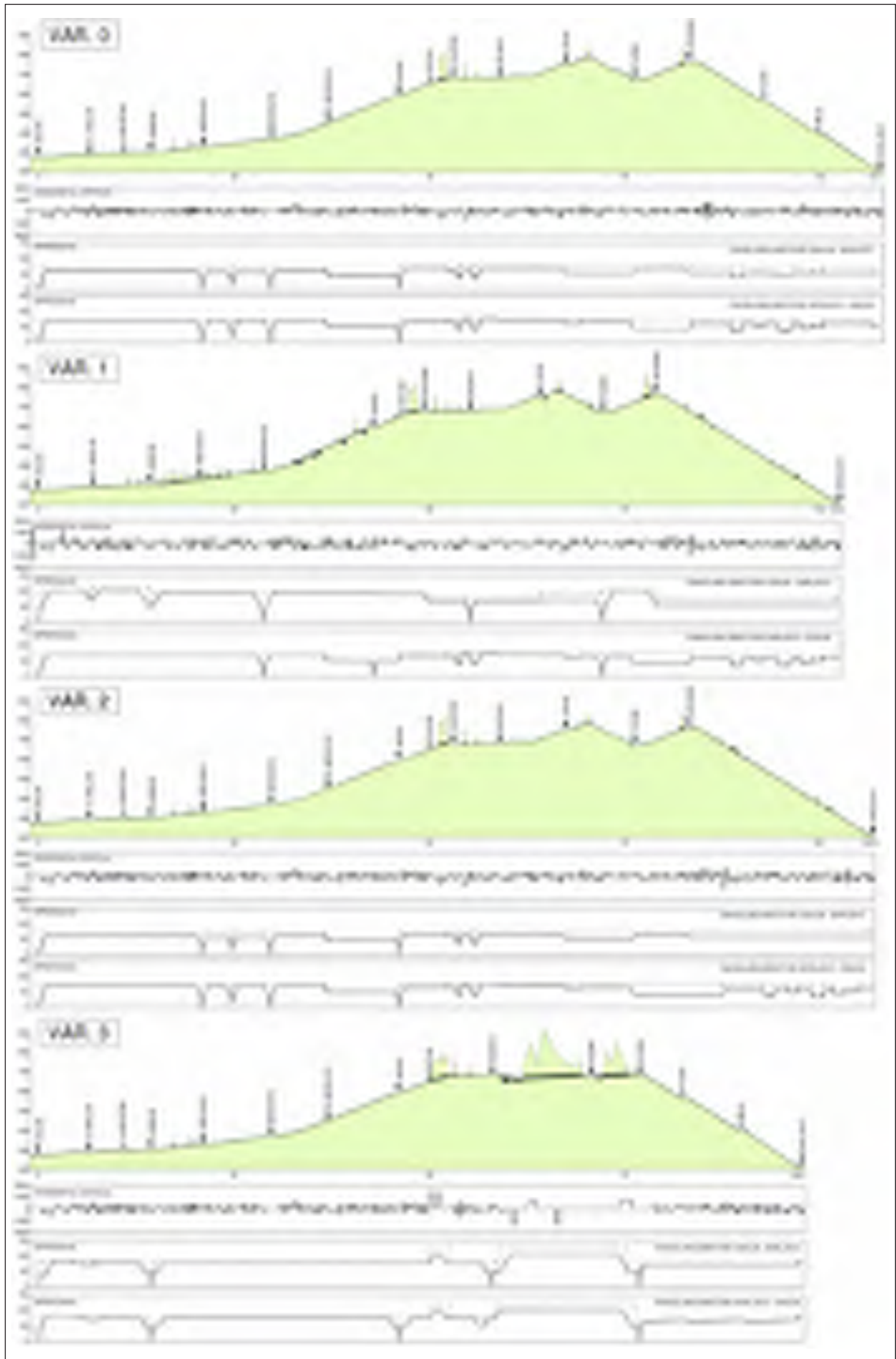


Figure 6 Variants VAR.0-3 vertical alignments and operating speed profiles

## 2.2 Traffic characteristics

Based on the geometry and traffic characteristics of the existing railway line (VAR.0) and variant solutions (VAR.1, 2 and 3) [7, 9, 10, 11], the following track technical and operational parameters necessary for freight capacity calculations were defined: interstation ruling gradient, type of haul (locomotive class), minimal gross weight of freight train, and operating speed. In VAR.1 and 2, the reduction of the longitudinal gradient, which demanded the abolition of stations Plase and Meja, reduced the highest ruling gradient from 26‰ to 24‰.

On the existing railway line, haul is performed by means of one or, at critical interstation sections, two electric class 1141 locomotives. It is assumed that the same class of locomotive will be used upon completion of the betterment. Based on the known haul and alignment characteristics, it was established that minimal gross weight of freight train (q) of 900 tonnes is achievable for each track variant, with two locomotives double-heading the service.

Calculated freight train operating speed that can be achieved for such route and towing characteristics is shown on Figure 5 for each travelling direction.

## 2.3 Interstation travelling time and carrying capacity

Freight train travelling time in both directions was calculated for each track variant on the basis of previously defined track technical and operational characteristics on interstation sections (Table 2). The longest interstation travelling time for each variant is calculated on track most challenging section from station Drvenik (i.e. Zlobin) to Škrljevo. The shortest total travelling time in both directions is achieved for VAR.1 (complete single track reconstruction). This is understandable, bearing in mind that this variant includes most significant improvements of track technical (horizontal and vertical design) elements.

**Table 2** Interstation travelling time.

Travelling direction Interstation section	Ogulin-Škrljevo				Škrljevo-Ogulin			
	VAR.0	VAR.1	VAR.2	VAR.3	VAR.0	VAR.1	VAR.2	VAR.3
Ogulin – O. Hreljin	8	4	8	7	7	4	7	7
O.Hreljin – Gomirje	8	5	8	8	7	4	7	8
Gomirje – Vrbovsko	7	4	7	6	6	6	6	8
Vrbovsko – Moravice	11	5	11	8	10	8	10	7
Moravice – Skrad	21	9	21	14	18	12	18	16
Skrad – Delnice	15	10	15	9	15	10	15	11
Delnice – Fužine	20	16	20	9	17	12	17	10
Fužine – Drivenik/Zlobin	7	4	7	6	11	5	11	5
Drivenik/Zlobin – Škrljevo	36	26	26	20	35	19	19	22
<b>Travelling time t [min]</b>	<b>133</b>	<b>83</b>	<b>123</b>	<b>87</b>	<b>126</b>	<b>80</b>	<b>110</b>	<b>94</b>

VAR.0 – Existing rail track (Ogulin-Škrljevo)  
 VAR.1 – Track reconstruction (Ogulin-Škrljevo)  
 VAR.2 – New double track (Drivenik-Škrljevo)  
 VAR.3 – Track reconstruction (Kupjak-Škrljevo) and second track construction (Delnice-Škrljevo) [6]

In order to define the capacity of the analysed variants, the maximum possible daily number of freight trains (n) on each track interstation section was defined according to:

$$n = 2 \cdot \frac{1440}{t_{\text{Ogulin-Skrljevo}} + t_{\text{Škrljevo-Ogulin}}} \quad [\text{min}] \quad (1)$$



Based on the calculated maximum possible daily number of freight trains ( $n$ ) and gross weight of freight train ( $q$ ) on each interstation section, annual gross capacity ( $Q$ ) was defined according to:

$$Q = n \cdot q \cdot D \cdot \psi \quad (2)$$

The calculations were conducted by adopting following presumptions: freight trains are in operation during  $D=300$  working days per year with coefficient of train mass utilization of  $\psi=0.80$  [6]. Results of these calculations are shown in Table 3.

Interstation section relevant for the calculation of the capacity of the entire track is the one with the smallest calculated number of trains per day i.e. interstation section Drivenik (Zlobin)-Škrljevo. Given the forecasted net freight traffic needs of 12 million of net tonnes by the year 2045, and the presumed gross to net capacity ratio of 2, it is estimated that existing rail section (VAR.0) will reach its maximum capacity by the year 2020. Single line track reconstruction variant (VAR.1) does not meet the forecasted transportation needs. They can be achieved only in the case of second track construction: estimated freight capacity of VAR.2 and 3 is by 13 and 19% higher than forecasted net freight traffic needs.

**Table 3** Variant capacity.

Capacity Parameter	Daily number of trains $n$				Annual capacity $Q$ [MGT]			
	VAR.0	VAR.1	VAR.2	VAR.3	VAR.0	VAR.1	VAR.2	VAR.3
Interstation section								
Ogulin – O. Hreljin	192	360	192	206	69.0	155.5	69.0	88.9
O.Hreljin – Gomirje	192	320	192	180	69.0	138.2	69.0	77.8
Gomirje – Vrbovsko	222	288	222	206	79.6	124.4	79.6	88.9
Vrbovsko – Moravice	137	222	137	192	49.3	95.7	49.3	82.9
Moravice – Skrad	120	137	120	169	43.1	29.6	43.1	73.2
Skrad – Delnice	180	288	180	144	64.7	62.2	64.7	62.2
Delnice – Fužine	137	180	137	303	35.8	38.9	35.8	131.0
Fužine – Drivenik/Zlobin	160	320	160	524	41.8	69.1	41.8	226.2
Drivenik/Zlobin – Škrljevo	41	64	128	137	10.6	13.8	27.6	29.6
<b>Ogulin – Škrljevo</b>	<b>41</b>	<b>64</b>	<b>128</b>	<b>137</b>	<b>10.6</b>	<b>13.8</b>	<b>27.6</b>	<b>29.6</b>

VAR.0 – Existing rail track (Ogulin-Škrljevo)  
VAR.1 – Track reconstruction (Ogulin-Škrljevo)  
VAR.2 – New double track (Drivenik-Škrljevo)  
VAR.3 – Track reconstruction (Kupjak-Škrljevo) and second track construction (Delnice-Škrljevo)

## 2.4 Estimated investment costs

Table 4 shows an estimation of investment costs calculated for track variants VAR.2 and 3. Since it can't meet the predicted traffic needs, VAR.1 was eliminated from cost analysis. By comparing the estimated investment costs the following conclusions were made. The manner of which VAR.3 route was designed results in the need to build a large number of expensive new tunnels and bridges. In contrast, VAR.2 does not predict complete redirection of the existing line route but only the correction of vertical alignment and critical sections of track with extremely small horizontal curves radii. Because of that, most of the VAR.2 investment costs refer to the track substructure construction. Also, the length of the predicted double track is two times shorter in VAR.2 than the VAR.3. All this makes the VAR.2 30% less expensive investment than the VAR.3.

**Table 4** Estimated investment costs.

Variant	VAR.2	VAR.3
Track substructure (earthworks and drainage)	296.1	87.4
Track superstructure	51.1	83.4
Bridges and tunnels	29.6	321.7
Crossings	6.0	8.1
Noise protection	4.0	11.7
Signaling	3.8	56.7
Central traffic control	0.3	2.1
Telecommunication	1.2	3.7
Electrification	5.6	23.7
Stations (accesses, platforms and buildings)	9.1	12.4
<b>Total investment costs [mil EUR]</b>	<b>406.7</b>	<b>610.8</b>
<i>VAR.2 – New double track (Drivenik-Škrljevo)</i>		
<i>VAR.3 – Track reconstruction (Kupjak-Škrljevo) and second track construction (Delnice-Škrljevo)</i>		

### 3 Conclusion

The necessary modernization of the M202 railway line section Ogulin-Škrljevo is still in the research phase. Variant analysis presented in this paper showed that a favourable solution to increase the track section capacity is to build a second track on the most critical Drivenik-Škrljevo subsection, about 23.5 km long. With regard to the forecasted Port of Rijeka net rail freight traffic needs, existing single track rail section will reach its maximum capacity by the year 2020. This means that there are only few more years available to design, construct and put in operation the second rail track. Otherwise, the existing line and station capacity will not be sufficient for the intended volume of rail freight transport, which would eventually lead to further, and this time perhaps irreversible, decline of railway system of this area.

### References

- [1] 2016 Network Statement, HŽ Infrastruktura, Zagreb, 2016.
- [2] Rijeka Gateway Project, Port of Rijeka Authority web page: [www.portauthority.hr/en/development\\_projects/rijeka\\_gateway\\_project](http://www.portauthority.hr/en/development_projects/rijeka_gateway_project).
- [3] Dundović, Č., Vilke, S., Šantić, L: The significance of high-efficiency railway Zagreb-Rijeka for the Port of Rijeka development, POMORSTVO-Scientific Journal of Maritime Research, 24/2, pp. 165-188, 2010.
- [4] Lažeta, T., Kralj, S., Tomić, T., Šmit Novoselec, V., Kljajić, S.: High performance railway construction project / state border-Botovo-Zagreb-Rijeka, First International Conference on Road and Rail Infrastructure, Opatija, pp. 533-540, 2010.
- [5] Hozjan, T.: Planirane aktivnosti na ogranku željezničkog koridora V.B. i unapređenje postojeće željezničke pruge Zagreb GK-Rijeka, PPT presentation for Institute for Physical Planning of the Primorje-Gorski Kotar County, web page: [www.zavod.pgz.hr/docs/zzpuHR/documents/319/Original.pdf](http://www.zavod.pgz.hr/docs/zzpuHR/documents/319/Original.pdf)
- [6] ŽELJEZNIČKO PROJEKTNO DRUŠTVO: The Study of Framework Possibilities for the Construction of the Second Track and the Renewal of the (Kupjak)-Delnice-Škrljevo Line Section – Traffic-Technological Conceptual Design, Zagreb, 2014.
- [7] ŽELJEZNIČKO PROJEKTNO DRUŠTVO: The Study of Framework Possibilities for the Construction of the Second Track and the Renewal of the (Kupjak)-Delnice-Škrljevo Line Section – Preliminary Conceptual Design of the Construction of the Second Track and the Reconstruction of Stations and Stops, Zagreb, 2014.

- [8] Traffic Strategy of the Republic of Croatia for the period from 2014 to 2030, Government of the Republic of Croatia, Zagreb, 2014.
- [9] Obad, I.: Conceptual design of the Zagreb-Rijeka railway line reconstruction, section Delnice-Škrljevo, Graduate thesis, University of Zagreb, Faculty of Civil Engineering, Mentor: Lakušić, S., Zagreb, 2015.
- [10] Vranešić, K.: Conceptual design of the Zagreb-Rijeka railway line reconstruction, section Oštarije-Delnice, Graduate thesis, University of Zagreb, Faculty of Civil Engineering, Mentor: Lakušić, S., Zagreb, 2015.
- [11] Instructions 52 on technical standards and data for the development and implementation of the rail timetables, HŽ Infrastruktura, Zagreb, 2006.



## THE EFFECTS OF GENERAL OVERHAUL RAILROAD IN FB&H

Mirna Hebib–Albinović<sup>1</sup>, Sanjin Albinović<sup>2</sup>, Ammar Šarić<sup>2</sup>

<sup>1</sup> Public Enterprise Railways of the Federation of Bosnia and Herzegovina ltd. Sarajevo

<sup>2</sup> University of Sarajevo, Faculty of Civil Engineering, Bosnia and Herzegovina

### Abstract

After completion of the first phase of the project of general overhaul main repair of the railway line from the state border (Čapljina) to Bradina, in the Federation B&H, a general overhaul from Bradina to Sarajevo, in total length of 36 km, currently is in progress. Implementation of Phase II of this project will be completed general overhaul of whole so-called south line from Čapljina to Sarajevo. General overhaul of railroad includes replacement of superstructure elements, while a just few works consider improving the substructure, structures (bridges, tunnels) and technical elements (radius of curves and etc.). This paper will give an overview of line condition before and after the general overhaul implemented, and effects of this way of implementation of the general overhaul in terms of increasing speed and traffic safety.

*Keywords: railroad, overhaul, increasing speed*

### 1 Introduction

The railway line from the state border (Čapljina) to Sarajevo, known as the “South railway” is one of the most important railway lines in Bosnia and Herzegovina, and it is part of Corridor Vc. Its importance is recognized by Austro-Hungarian monarchy, which, eager to establish communication to the sea, decided to build the railway.

The first section of this line from Metković to Mostar was opened at 14.6.1885, and at 22.08.1888. section Mostar – Ostrožac was opened. The first train arrived in Konjic at 10.11.1889. Part of the railway from Konjic to Sarajevo was opened at 1.8.1891. and in that way connection with Adriatic sea was made.

The biggest problem on this section was a watershed Ivan sedlo, a boundary between Black and Adriatic sea, which is overcome by applying steep longitudinal slope (up to 60 ‰ on the section between Konjic and Bradina, and up to 35 ‰ between Pazarić and Bradina). The steep slope problem on these sections was partially solved in 1931. when long tunnel Bradina was build (322.3 m). This narrow gauge is modernized and become normal gauge in 1968., and a year later was electrified.

After the war (1992-1995), the damage was repaid, but from 2004. there have not been any serious reconstruction works. That year, general overhaul on the most difficult section of the railway (Bradina – Konjic) began.

Based on the strategy of the reconstruction and development of the railway sector in Bosnia and Herzegovina (Regional project “Reconstruction of railways in B&H II”), during 2014, reconstruction of south part of the corridor Vc (100 km of railway – state border with Croatia – Čapljina – Mostar – Raška Gora – Čelebići (Konjic)) was completed. Whereas previously was done reconstruction of the Konjic – Bradina railway, the next task was to ensure the project and funds for reconstruction of remaining part of the railway from Bradina to Sarajevo, in total length of 42 km. Necessary funds and design for reconstruction of the final section from Bradina to Miljacka junction are provided, so realization of this project began in 2015. and is still in progress.

## 2 Parameters and conditions of the railway Sarajevo-Čapljina before general overhaul

The railway is single-track line and mostly build in extremely adverse terrain conditions. The-refor, in order to avoid high costs of building, it was necessary to apply minimum geometric elements. The total length of this section is 171.76 km and the entire length of the railway is electrified and equipped with signal-safety devices. The total length of straight line is 80.54 km (about 47%), while 91.21 km are curves (about 53%). The minimum applied curve radius is 250 m, while maximum is 10,000 m.

Figures 1 and 2 shows the presence of a certain curve radius, as well as a percentage share of certain curve radius in total length of curves. The railway was originally designed for speed of 70, 80 and 100 km/h. However, these geometric parameters are, according to the regulations, for speed below 100 km/h. For that reason, there is speed limit of 70 km/h for most of the route, while only small percentage of railway allows speeds higher than 90 km/h.



Figure 1 Number of curves

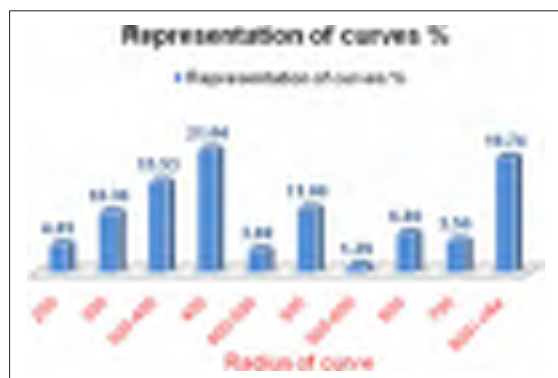


Figure 2 The presence of curves

There are a lot of objects on this railway, 99 tunnels (22% of the total railway length) and 51 bridges/viaducts (2% of the total railway length). Tables 1 and 2 shows the number of the objects per sections.

**Table 1** The presence of tunnels per sections

Section	Length [m]	Tunnels		
		No	Length [m]	Length ratio [%]
Junct. Miljacka – Bradina	34,079.00	11	7,759.00	23.00%
Bradina – Konjic	25,245.00	45	11,753.00	47.00%
Konjic-Raška Gora	50,211.00	35	14,117.00	28.00%
Raška-Gora-Čapljina	56,255.00	8	3,037.00	5.00%

**Table 2** The presence of bridges per sections

Section	Length [m]	Bridges		
		No	Length [m]	Length ratio [%]
Junct. Miljacka – Bradina	34,079.00	11	930.00	2.73%
Bradina – Konjic	25,245.00	16	1,165.00	4.61%
Konjic-Raška Gora	50,211.00	16	1,601.00	3.19%
Raška-Gora-Čapljina	56,255.00	8	330.00	0.59%

In the period after the war to the beginning of the general overhaul (1995-2005) there were not large traffic accidents. Before reconstruction of the railway superstructure, railway age was about 40 years. Existing track features allows driving speed up to 100 km/h and they not satisfy some of the basic criterias (Table 3) of the European Agreement on Main International Combined Transport Lines and Related Installations (AGTC).

**Table 3** The basic parameters of the railway Sarajevo-Čapljina

Parameters	Sarajevo-Čapljina	AGTC		
		Existing lines	New lines	
1. Number of tracks	1	–	–	2
2. Loading gauge	UIC B/C1		UIC B	UIC C1
3. Minimum distance between tracks [m]	–		4.0	4.2
4. Nominal min. speed [km/h]	50	100	120	120
5. Allowed mass per axle [t]	22.5t	20	22.5	22.5
wagons ≤ 100 km/h		20	20	
≤ 120 km/h				
6. min. usable length of secondary track [m]	approx. 500	600	750	750

Based on these data (Table 3) it can be concluded that the largest deviations of the existing railway line parameters, in relation to AGTC, are in terms of the nominal speed.

Figures 1 and 2 shows that there are 309 curves on this railway section, with 210 curves (68%) of radius smaller than 600 m, which is 76.27% (69,859.44 m) of the total length of curves (i.e. 40% of the total length of the section). So, to accomplish the regulations in terms of driving speed, it is necessary to change alignment parameters on the large part of the route. Before general overhaul of the first section started, the busiest line in terms of passengers traffic was Sarajevo – Konjic section, while in terms of freight traffic it was section Mostar (Bačevići) – Čapljina (state border) (Table 4).

**Table 4** Passengers and freight traffic on the Sarajevo – Ploče railway

Section	Passengers traffic		Freight traffic	
	Passengers [1000/year]	Pair of trains	Freight [1000 t/year]	Pair of trains
Junct. Miljacka – Bradina	150	17	200	8
Bradina – Konjic	120	17	200	8
Konjic-Raška Gora	90	17	200	8
Raška-Gora-Čapljina	30	12	200/450	18

Although, traffic study that preceded the main design, predicted increase of the passengers and freight traffic, in last ten years there has been further reduction in passengers traffic volume, while freight traffic volume remain the same.

### 3 The main design of the general overhaul

Since the “southern railway” is one of the most important transport lines on the Pan-European corridor Vc, in the process of developing of the strategy for reconstruction and development railway sector in Bosna and Herzegovina, priority was the reconstruction of this railway line. The main objective of the reconstruction design is to increase the safety of traffic, increasing the speed and reducing the cost of operation and maintenance.

Traffic studies and main designs were prepared with EU grant funds, and EBRD London and EIB Luxembourg credits were used for realization of this project, which took place in the following stages (Table 5). These costs (Table 5) are related to the construction costs, while the costs of renewal of signaling on the Konjic – Čapljina (ŽFBH) section amounted to 11.742.602,72 euros.

**Table 5** Project realisation overview

Section	Year	Contractor	Investment [€]
1. Junction Miljacka – Bradina	2015.	GCF-Generale Costruzioni Ferroviarie / Hering d. d. Š.Brijeg	25,418,039.00
2. Bradina – Konjic	2005. – 2006.	POOR Wien / Remont pruga d.o.o	16,000,000.00
3. Konjic-Raška Gora (ŽFBH)	2009. – 2011.	Swietelsky / Alpine, Austrija	26,099,226.25
4. Raška-Gora-Čapljina (ŽFBH)	2009. – 2011.	Swietelsky / Alpine, Austrija	25,008,123.08

According to the terms of reference, replacement of the superstructure elements (rails, sleepers and ballast) and switches and establishment of the continuous welded rail are most important works, while there are just a few planned works on the substructure reconstruction (only drainage works and rail body stabilization). More complex works are processed in a special individual projects. The ratio of investment between superstructure and substructure is approximately 70% -30%.

### 4 General overhaul effects

The effects of general overhaul are manifested through increased traffic safety, reduced costs of superstructure maintenance, increasing speed where terrain conditions and track geometry parameters allows, improving drainage and reduced maintenance costs of rolling stock. The largest effects of conducted overhaul “of the southern railway” is reflected in the increase of traffic safety and the lowest in terms of increasing the driving speed. Of course, the main reason for this is that geometric elements have not changed (repaired) so the speed remained almost the same (Table 6).

Thus, most part of sections with horizontal curve radius of 300 m still has speed limit of 75 km/h. The exceptions are few sections of the railway Raška Gora – Čapljina where speed is a

little bit higher (up to 90 km/h) and section Bradina – Konjic, with minimum curve radius of 250 m and a maximum longitudinal slope of 23 ‰, where possible speed is of up to 70 km/h. Comparing speed on the basis of the timetable before and after the track overhaul, it can be noted that they remain the same, up to 70 km/h for passengers and 50 km/h for freight trains, except on section Bradina-Konjic where speed of 50 km/h is also for passenger trains.

## 5 Conclusion

In order to achieve the competitiveness of rail with other modes of transport and especially in terms of passenger traffic, it is necessary to increase the capacity and driving speed. The realization of the railway reconstruction project, which is in progress and applies only to the reconstruction of the track without geometric elements correction and substructure reconstruction, these objectives cannot be achieved.

Therefore, this project can and should be seen as the first stage in the process of revitalizing the railways in B&H, while in the second phase should be based on finding solutions to the corrections of the route in order to increase speed and to meet the basic conditions of the signed agreements (AGTC).

Special attention should be paid to the substructure structures (tunnels and bridges) whose construction is quite dilapidated and require prior extensive testing and reconstructions. Since there is a highly challenging terrain conditions, it would require the construction of a completely new sections independent of the existing route that can be considered and second track. This approach to the reconstruction of the railway is a major advantage because it increases line capacity and allows the smooth traffic flow on the existing railway line, which was one of the main problems in the implementation of the overhaul project.

Of course, the key factor are costs, because it is an extremely difficult terrain and the improvement of the route is only possible by using large (long) structures (tunnels and bridges) which requires major investments. For this purpose it is necessary to make a detailed analysis and determine the highest priority sections where we can expect a return on investment. In addition, what is crucial for the revitalization of the railway is a change of transport policy so that the railway is the “backbone” of transport system.

## References

- [1] Study of upgrading of the railway line Sarajevo – Ploče, Sudop Praha a.s, 2008.
- [2] The amended Main design Vc railway Sarajevo – Čapljina, section Bradina – Konjic, IPSA Institut Sarajevo , 2003.
- [3] Main design for the reconstruction of railway track and signalling system on the railway line Sarajevo – Bradina, C.LOTTI & ASSOCIATI- Societa` di ingegneria S.P.A , 2008.
- [4] Main design of reconstruction of railroad and sign work of BiH railways, Section “A” – Konjic – Mostar – Čapljina – State border; Željezničko projektno društvo d.d. Zagreb & IPSA Institut Sarajevo, 2006
- [5] <http://www.zfbh.ba/>







## RECONSTRUCTION AND MODERNIZATION OF RAILWAY SUBOTICA (FREIGHT) – HORGOS – SERBIAN-HUNGARIAN BORDER

Ljiljana Milić Marković<sup>1</sup>, Ljubo Marković<sup>2</sup>, Goran Ćirović<sup>3</sup>

<sup>1</sup> CeS COWI, Belgrade, Serbia

<sup>2</sup> Faculty of Technical Sciences in Kosovska Mitrovica, Serbia

<sup>3</sup> Univ. College for Civil Eng. and Geodesy, Belgrade, Serbia

### Abstract

The paper presents the necessary works included in the project for construction, reconstruction and modernization of the railway Subotica (Freight) – Horgos -Serbian-Hungarian border, with a total length of 27.9 km. Considering that the technical characteristics of the existing lines do not meet the requirements of modern transport systems, the implementation of these works will result in a high-quality interoperable railway link for both freight and commercial (passenger) traffic and a connection between regional centers in the border region (Szeged – Roszke – Horgos – Subotica – Csikeria – Bacsalmás – Baja). The project represents the first phase of work on the construction of the future railway (East-West) corridor between corridors IV, V, VII and X.

*Keywords: reconstruction, modernization, railway track, transport systems, interoperability, corridor*

### 1 Introduction

From 1908, the railway line for the relation Szeged – Roszke – Horgos – Subotica – Csikeria – Bacsalmás – Baja was part of the Great Hungarian Plain – Rijeka railway line, which made it possible for producers of agricultural products from the Pannonian Plain to have access to ports on the Adriatic Sea. After World War II, due to the construction of new border crossings between the Former Yugoslavia and Hungary, the railway lost its significance and in 1960 it was closed to rail traffic. Several sections of the track between Bacsalmás and Subotica have been dismantled and removed.

The Government of the Autonomous Province of Vojvodina, the Agency for Euro-regional development of the Danube – Cris – Mures – Tisa (DKMT), Hungarian Railways and Serbia Railways have initiated work on the reconstruction and modernization of this railway route in order to establish new connections between the Hungarian Southern Great Plains and Vojvodina in Serbia, and the Western region of Romania, thus connecting the major logistics centers in the region (Szeged, Subotica, Baja), including the intermodal port of Baja on the Danube River and the port of Szeged on the Tisa River. The completion of this project will create new, modern intercity public transport connections within the DKMT Euroregion which will provide greater comfort for the transport of passengers commuting between the major urban centers of the area.

Works on the project have been undertaken in order to develop a European network of roads and European corridors. Construction, reconstruction and modernization of the Szeged – Roszke – Horgos – Subotica – Csikeria – Bacsalmás – Baja railway lines represents the first phase of the future East – West railway corridor between the Pan European Corridors IV, V, VII and X (Figure 1).



**Figure 1** Position of the Szeged – Roszke – Horgos – Subotica – Csikeria – Bacsalmas – Baja railway line [1]

## 2 The current state of the railway

The railway line Subotica (Freight) – Horgos – Serbian Hungarian border, according to Regulation 325 [2] is number 26 and it is 27.90 km long. The line is flat, single-track and non-electrified. It is intended for mixed traffic, but in its present condition its function is of importance for regional passenger traffic. The technical condition of the substructure and superstructure corresponds to category “A” (permissible weight per axle is 16 t and 5 t per meter), Figure 2. The speed at which trains run on the tracks is 80 km/h on the section from Subotica (Freight) to Bački Vinogradi station, while on the section from Bački Vinogradi to the border with Hungary trains travel at a speed of 20 km/h. The minimum radius of curvature on the route is 300 m which is found in the station area of Subotica Freight, while the maximum gradient of the finished track level is 6.67‰ for a length of 210 meters. Based on the results of a measured drive, for a length of 11 km the state of the track was rated as unsatisfactory [1].

The railway line has one underpass, four overpasses, seventeen small buildings of up to five meters in length and nineteen level crossings (14 on the open line and 5 in station areas). The existing buildings are in very poor condition, dilapidated, as some of them are over 100 years old [1].

Service buildings situated on the line are Subotica Public Warehouses, Palić, Hajdukovo, Bački Vinogradi and Horgos. All of these service buildings are open for work in passenger transport. The building structures are in good condition. The facades are dilapidated, and the sidewalks and steps are completely neglected. The basement rooms are ruined. The equipment in the buildings is worn out [1].

The space in which this railway line is situated belongs to the Danube Basin (Tisa sub-basin). For the majority of the route on this terrain there is a constantly high level of groundwater. The recipients of the channels that intersect the railway route are Paličko and Ludoško Lakes and the Tisa River, as well as local retentions and depressions.



**Figure 2** Track on the existing railway line Subotica (Freight) – Horgos – Serbian Hungarian border [1]

The noise resulting from the traffic flow is intermittent, of variable intensity, with periodic pulses. Since there is a lot of housing in the immediate vicinity of this section of the track, it is essential to implement appropriate measures of protection against the adverse effects of traffic noise.

The only electrical installations on the line are those which include low voltage connection cables for the service buildings, outside lighting for these buildings and indoor electrical installations in the service buildings. The existing railway route is in collision with power lines with a voltage of 400 kV, 110 kV, 20 kV and 0,4 kV [1].

The transport of consecutive trains is based on the station schedule. Palić Station is secured with an electromechanical blocking device. There is a central blocking device in the signalman's office in the station building. Palić Station is protected by mechanical main entrance signals with separate distant signals. Bački Vinogradi Freight Forwarding is not protected by main signals. The switches are attached, secured with switch locks that are handled on site. Horgos Station is secured by mechanical – token blocking device. A central mechanical device is installed in the signalman's office. Horgoš Station is protected by mechanical unambiguous visual signals with distant signals. The switches are secured by switch locks (attached), they are placed on site and do not depend on the input signals [1].

For communication between the service buildings about the flow of rail traffic on the line, the following are used: from Subotica Station to the service building at Palić, as well as from the service building at Horgos to the one at Reske (Hungary) there is a TD 59U 4 x 1.2 cable, while between the service buildings at Palić and Horgos communication takes place by means of PTT connection. Service and signalling telephone cables can only be found on the section Subotica – Palić [1].

### **3 Reconstruction and modernization of the railway line Subotica (freight) – Horgos – Serbian Hungarian border**

The term reconstruction of the railway implies the creation of a new quality in relation to the projected state. Reconstruction includes works on: the substructure and superstructure of the railway line, engineering constructions, architectural, hydro technical and other buildings, electric traction and electric power plants, signalling and security systems and devices, telecommunication systems and equipment, other facilities and equipment at railway service places concerned with the organization and regulation of rail transport, with the land that serves these buildings, the rail belt and air space above the railway line [3].

#### **3.1 The substructure of the railway and service buildings**

the project elements for the substructure of open tracks, stations and other service buildings are determined in accordance with the Project task: the railway line is designed as single-track, electrified, inside the existing rail belt; the railway is designed for category D4

(permitted axle load of 22.5 t and weight allowed per meter of 8.0 t/m); free profile UIC GC was adopted for the electrified tracks, system 25kV/50Hz for a projected speed of up to 160 km/h; the border elements of the project plan and the profile of the substructure are for a projected speed of up to 160 km/h, except in the area of Subotica Junction (exit from the station Subotica Freight); the substructure on the open tracks is designed with a formation width of 7.00 m and with a one-sided transverse gradient of 4%; in the station area (between the entrance signals), and within the framework of the width of the formation, the plan proposes a prefabricated channel for holding the installations from either side of the final external tracks; construction of the substructure was designed based on the established engineering of the geological and geotechnical characteristics of the terrain and the characteristics of the material to be installed in the substructure, with a transitional and protective layer, and in accordance with guideline 338/ZIŽ [4]; the design of the reconstruction of the service buildings is in line with the technical requirements, the needs of the catchment area stations and local conditions in the area concerned; the track capacity of the stations, and the length of the track and platforms are designed according with technological requirements, and on the basis of the established engineering of the geological and geotechnical characteristics of the terrain and the available material [1].

On the open line and main through tracks in stations a free profile was secured in accordance with the Project task, and which is defined by the Rules on the design of the reconstruction and construction of certain elements of the railway infrastructure of individual main railway lines [5]. The distance between the tracks in the stations is 4.75 m, while the distance from the track axis to the edge of the formation for all service buildings is 3.5 m [1].

### 3.2 The superstructure

the projected elements of the superstructure of the new single-tracked section are adopted for a projected speed of up to 120 km/h. On the open line, the installation of type 60E1 tracks is envisaged, with a tensile strength of 880 N/mm<sup>2</sup> (quality 900A), welded together with an elastic track fastening system. The switches on the main passing track are type 60E1-300-6°, while on the remaining tracks in the service buildings the switches are type 49E1. On the open track, one-piece pre-stressed reinforced concrete sleepers are installed, with a length of 260 cm, with elastic fastening at an axial distance of 60 cm. The total thickness of the construction of the superstructure with this sleeper is 70 cm. The ballast prism is made of crushed stone, and the height of the ballast prism from the lower edge of the track to the formation of the track is a minimum of 30 cm (under the inner track), the width from the top of the sleeper to the upper edge of the ballast prism is 50 cm, and the slope of the ballast prism has a gradient of 1 : 1.5 [1].

### 3.3 Level crossings

Development of the level crossings is planned to take place in several phases. In the first phase the level crossings are maintained, the electrical equipment is secured and the stipulated traffic signs are put into place. In the next phase, on the basis of the estimated costs and insurance benefits / delevelling of the crossing, optimization of the number of level crossings is carried out with the active participation of local governments. The requirements of the urban and spatial environment for technical intervention at the crossing will have an important effect on the optimization process and the establishment of road transport links in the event of shutting down a certain level crossing [2].

### 3.4 Engineering constructions and buildings

The project foresees new buildings in place of the existing ones, a reinforced concrete retaining wall with a length of 123.38 m, a road underpass 21.50 m long (Figure 3), pedestrian

underpasses at Palić (L=54.75 m) and Horgos (L=26.6 m) stations and 10 trough shaped box culverts with winged walls of different holes [1].

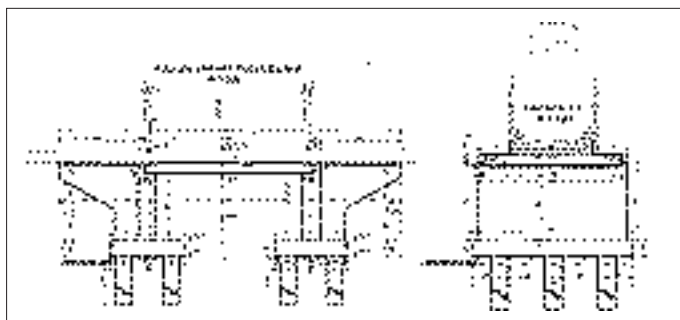


Figure 3 Underpass with length L=21.50m at km 1+485.02 [1]

### 3.5 Architectural buildings

As part of the reconstruction and modernization project, the adaption of station buildings is planned, Figure 4. In accordance with the necessary facilities and equipment for the staff and passengers, the plan envisages the construction of platforms and canopies, underpasses, new facilities for the accommodation of safety signalling and telecommunication devices (SS and TT), and installations for sectioning (PS).



Figure 4 The station building at Horgos [1]

### 3.6 Hydro technical works

The project retains the dimensions of the existing culverts. In the immediate vicinity of buildings, to protection them from erosion, riverbed channels are coated with an appropriate coating. The flow through the buildings is largely calm. Draining the tracks in stations is envisaged with drainage pipes laid between the tracks [1].

### 3.7 Facilities for protection against noise

the project envisages the construction of protective structures – walls for protection against noise, which would eliminate its negative impact. The height and length of the walls was determined on the basis of calculations of noise levels, using the CadnaA software. The height of the walls was determined so as to provide a reduction in the level of traffic noise to below

the permitted level in settlements along the planned railway line (55 dB(A) during the day 45 and dB(A) during the night). A number of different solutions were considered, and a solution was proposed that should meet the following criteria: weather resistance, rational structure, visual effects, the possibility of pre-fabricated construction, the possibility of being upgraded, spatial compatibility and easy maintenance [1].

### **3.8 Electrical installations**

according to the reconstruction and modernization project, the railway will be electrified with a single-phase system of 25kV, 50Hz adopted for the electrification of railways on the network. Electrification of the railway includes the construction of: stable electric traction facilities (contact network, installations for sectioning, remote management with stable electrical traction installations), upgrade (non-traction) of the electrical installations, as well as the relocation of power lines in places where they collide with the electrified tracks [1].

### **3.9 Signal – safety installations and equipment**

in order to ensure the technical possibilities for interoperability and compatibility with different types of traction vehicles used in the Pan European corridors, bearing in mind the possibility of increasing the maximum speed on the line in the near future, this project anticipates that electronic signal-safety equipment (ESSE) must have the possibility of being upgraded to the European train control system (ETCS) thereby creating many advantages over other systems (interoperability, security, continuous access to information about trains, their position, speed and interval succession, and the management of trains with greater flexibility and efficiency) [1].

### **3.10 Telecommunication installations and equipment**

the project for telecommunication installations and devices envisages the installation of a telecommunications system for the line which will consist of the following subsystems: cable installations (copper railway cable, local cables in stations and optical cable), a transmission subsystem based on SDH (Synchronous Digital Hierarchy) technology, track telephones and dispatch connections in modern technology with software programming and a local technological radio-network in Horgos Station (for maneuvers, maintenance and conversations in the office) [1].

### **3.11 Investment value**

according to the prices given in the project (October 2015) the total investment value of the works for the reconstruction and modernization of the railway Subotica – Horgos – border of Serbia and Hungary amounts to € 46,084,194.53, or € 1,730,537.00 / km. On the basis of the Feasibility Study, the economic internal rate of return was obtained, which is very close to the discount rate (5.29 < 5.5). The ratio of benefits and costs, for a discount rate of 5.5% is 0.97, while for a discount rate of 5% it is 1.04 [1].

## **4 Conclusions**

Based on its current characteristics, the regional railway line Subotica (Freight), which is situated on the railway route Szeged – Roszke – Horgos – Subotica – Csikeria – Bacsalmás – Baja cannot meet the demands of a modern traffic system. The reconstruction and modernization of this railway line will achieve:

- improvement of the accessibility of the Euroregion Danube-Kris-Mures-Tisa by creating a high-quality interoperable rail connection for passenger and freight for the relation east-west, since a good and economically effective transport system is a prerequisite for maintaining high economic growth and advancing Euro-integration
- improving connectivity within the Serbian – Hungarian (- Romanian) border areas by developing an effective transport system, and potential improvement of conditions for accelerated regional development, as well as
- the transition from road to rail transport and the mitigation of impacts on the natural, historical and built environment in the study area, thus improving the sustainability of transport and resulting in beneficial effects on the environment.

All of the indicators analyzed in this study show that the project is on the limit of feasibility. From the socio-economic point of view, the project is highly justifiable. It is essential to co-finance through EU funds to the value of 66% of the total investment.

## References

- [1] CeS COWI: Feasibility Study and Preliminary Design of the reconstruction and modernization of the railway Subotica – Horgoš – Hungarian border, Belgrade, 2014.
- [2] Community of Yugoslav Railways – Regulation 325 on the categorization of railway lines YR with amendments, Belgrade, 1997.
- [3] Milić Marković. Lj., Marković, Lj.: The objectives of reconstruction and methodology for the design of reconstruction of railway lines – Construction no.9-10 (2010), p.536 – 552
- [4] Guideline 338 for the control of compaction of the substructure of railway lines by the dynamic method with a device with an easily falling weight on the network of railways YR, Belgrade, 2006.
- [5] Rules on the design of the reconstruction and construction of certain elements of the railway infrastructure of individual main railway lines, Official Gazette of RS no.100/2012.







## THE SPECIFICITY OF TECHNICAL CONSTRUCTIONS REGIMES INSIDE TERMINALS AND LOGISTICS CENTRES

Krzysztof Gradkowski

*Warsaw University of Technology, Poland*

### Abstract

The paper identifies the main problems with the technical implementation of logistics par in terms of construction. The structure is a par logistics facility construction constitutes a separate area equipped with various constructions, mainly paving of roads and drainage and runoff control system of surface waters. Both construction systems protect the safety in use and structural stability par logistics. Indications and specifications of the basic elements of structural systems par logistic equipment are included in the area of cognitive goals designers and building contractors. Detailed recommendation regarding some technical solutions de-saturated surface is essential in order to increase the reliability of solid technical facilities equipment logistics par engineering.

*Keywords: roads, railroads, drainage, transition of structures systems*

### 1 Introduction

Intensive development of intermodal and multimodal transport systems requires the construction of new or reconstruction of existing logistics centres. Existing road and rail transport is the primary factor shaping the political systems of individual technical building components within the created logistics centre. From the engineering point of view the basic problem is the construction of a par logistics. The building is equally logistics facility construction constitutes a separate area equipped with various types of buildings, mainly surfaces of roads and the system of control runoff of surface waters from the par [1]. In many cases we have to deal with the construction of multi-storey equally surface in the form of bridges. This type of construction requires separate technical solutions and functional based on bridge structures [2]. As an example of the construction platform entry into the parking lot second level open. Reinforced concrete, steel, and wood can provide various forms of logistics par in the form of an open multi-storey car parks, loading docks, piers, etc. Subject of publication in terms of classical civil engineering, which implies direct desirability of this article involves identifying the basic technical problems arising in the construction of a par logistics. Approximation of these issues in particular designers of such buildings can be very helpful and is independent of the level of detail of their presentation. General description of the problem is in the reference [1].

### 2 Engineering systems of platform logistics par

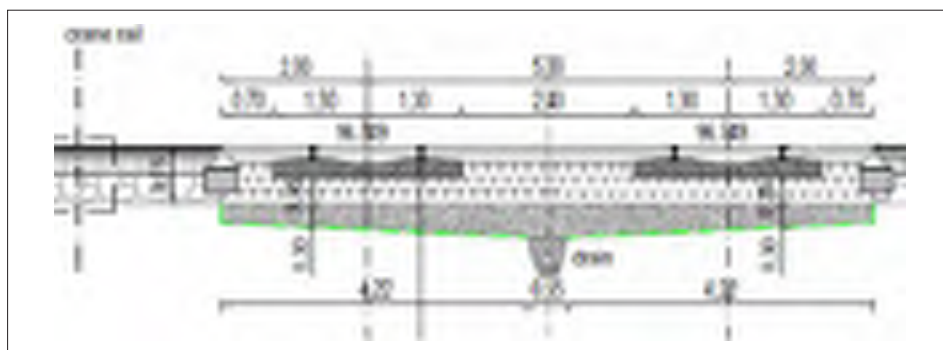
The basic equipment of almost every par logistics are surfacing automobile and rail surfaces. They constitute an essential part of functional equal and significantly affect the efficiency of all operational and commercial logistics facilities within the centre. Each kind of surface is part of the transport system and consequently the effectiveness of interconnections becomes necessary. The main engineering challenge is to build a durable surface car-rail. This applies

equally on the surface and equally situated in the concrete structure or steel. Basic assumptions devices construction paving of roads in general are shown in Figure 1. These multilayer systems, the structure and set of material it must be implemented in all conditions.



**Figure 1** General principle of pavement construction of highways and rail roads

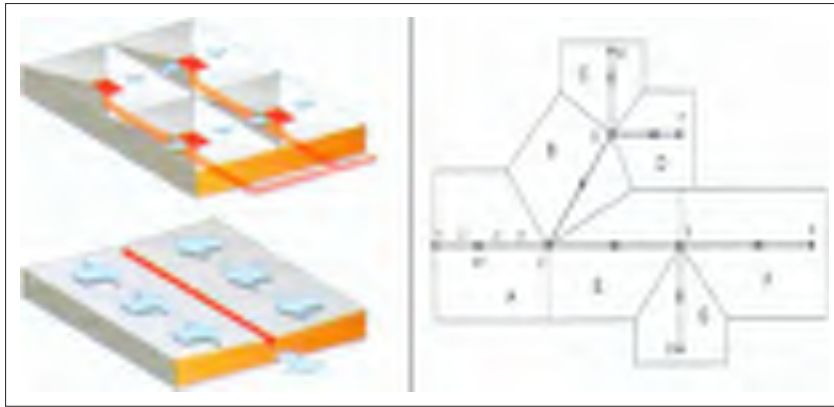
Technical and technological application of the principles of multi-layer construction solutions paving of roads to ensure the safety and stability of the structure itself and secure way to use the full functionality of the logistics par. Any destruction and defects regimes coats equally as automobile and railway leading too difficult to estimate the losses and failures supplies. Operational reliability of these structures is therefore a primary thing. It should be noted that the issue of the proper construction of the road surface, extremely clearly exists for a par logistics structures located on the platforms. Figure 2 shows a typical solution of two types of road surfaces of land located on the surfaces of equal logistics par. Building materials for the construction of these roads are aggregate and cement.



**Figure 2** Connection surface paving and rail within the logistics par – technical solution

### 3 Draining paving surface on a par

Reliability construction jobs surfacing in the area of equal logistics is closely linked to the drainage system and control the flow of rainwater. The basic criterion for its construction is to ensure the proper performance of the free inflow and receipt collected from the surface rainwater and others. Drainage systems and control runoff are integrally related to the structures and transport surfaces of the substrate. Relatively large areas sealed road surfacing require efficient drains flowing water. Drains can be installed as a point or as a slot, Figure 3.



**Figure 3** Exsamples of diagrams, drains, surface runoff point and slotted

The main issue in determining the technical solutions to the control system of paving surface runoff and drainage of rainwater is accurate to predict the amount of water feeding the system. The general formula for calculating runoff rainwater is eqn (1)

$$Q = q \cdot F \cdot \Psi \cdot \Phi \quad (1)$$

Where:

- Q – amount of runoff [dm<sup>3</sup>/s];
- q – rainfall intensity [dm<sup>3</sup>/(ha·s)];
- F – catchment area [ha];
- Ψ – runoff coefficient [-];
- Φ – delay factor outflow [-].

Equation (1) requires the establishment difficult to accurately calculate the coefficients and delays the trailing drain. The technical solution is generally used flow performance data obtained from the directory. Therefore, the eqn (1) is important for the overall comparison and calculation for the individual and specific technologies for the logistic equal. In practice, very effective solutions are considered to be slotted grooves. Their considerable performance in the reception of water runoff due to the fact of their linear structure. Figures 4,5 and 6 show examples of their installation in pavement construction vehicles or car-rail transition. For obvious reasons, they can only be used in surface regimes surface, with the exception of dehydrated equal par located on the structure. Recommending such outlets stems from practical experience proven in years of use. The efficiency of the technical equipment receiving rainwater and snowmelt has a direct impact on the functioning equally as logistics systems engineering structures. Significant advantages are slotted outlets:

- uniform, stable and repeatable ways of anchoring in the surface layers,
- stenosis technical way demarcation regimes coats of different thicknesses and purpose,
- can be easily supplemented inlets dotted with wells, thereby raising the productivity drain,
- easy maintaining the current.

Figures 4, 5 and 6 are examples of different types of linear grooves slotted for the various types and kinds of road surface.

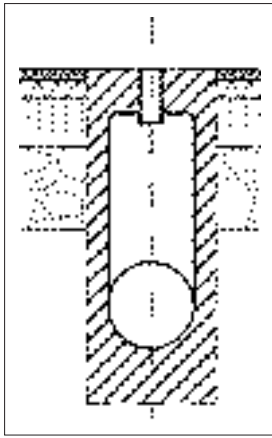


Figure 4 Gully slot-type light

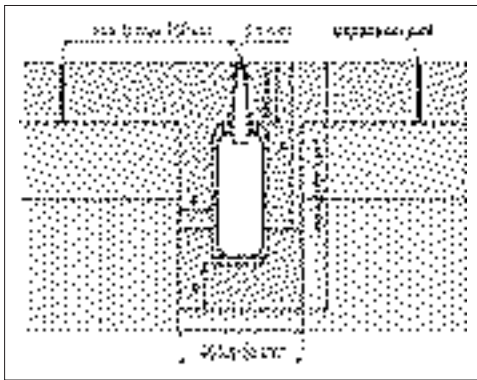


Figure 5 Keyway slot heavy- type version of male

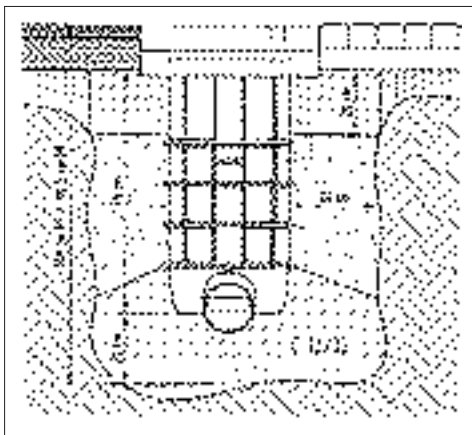


Figure 6 Keyway slot heavy type in the high version.

## 4 Conclusions

Topcoat pavement, rail and drainage systems design in the field of structures constituting the logistic par are the basic engineering equipment logistics centres. Efficient control systems rainwater protect the safety and stability of the structure coats. Specifications of the basic elements of structural systems equipment par logistics are in the area of cognitive goals designers and building contractors. Detailed recommendation regarding some technical solutions dehydrated surface is essential in order to increase the reliability of fixed technical equipment engineering par logistics. Operational experience shows that the slot structure of the surface drainage outlets are equally effective and adequate to safeguard the security of the entire system of equal surface logistics.

## References

- [1] Gradkowski, K.: Urządzenia techniczne dróg. Oficyna Wydawnicza Politechniki Warszawskiej, Warszawa 2012.
- [2] Stahlbock, R., Vos, S.: Operations research at container terminals: a literature update. Springer-Verlag, pp. 1-32, 2007.
- [3] Taniguchi, E., Michihiko, N., & others: Optimal size and location planing of public logistics terminals. Transportation Research Part E 1999, pp. 207-22.





## CROATIAN AIRFIELDS – POTENTIAL FOR AVIATION TOURISM DEVELOPMENT

Ivana Barišić<sup>1</sup>, Gordana Prutki-Pečnik<sup>2</sup>, Goran Ratkajec<sup>3</sup>, Roman Cvek<sup>4</sup>

<sup>1</sup> *University of Osijek, Faculty of Civil Engineering Osijek, Croatia*

<sup>2</sup> *Eracon Projekt Ltd., Croatia*

<sup>3</sup> *Aeroklub Cumulus, Croatia*

<sup>4</sup> *Rona trade Ltd., Croatia*

### Abstract

Similarly to potential of nautical tourism, which was unexplored until the construction of ACI marinas in the 80s, aviation tourism is insufficiently exploited branch of tourism in Croatia. The potential for aviation tourism development lies in the existing market potential of the European Union with about 100 000 registered private sport aircrafts (general aviation) and 300 000 pilots and potential of annual indirect income of approx. 40 mill. €. Great potential for development of aviation tourism in Croatia lies also in already available infrastructure. Namely, there are 20 airfields in the Republic of Croatia among which some are only insufficiently exploited, while others are abandoned and undeveloped. In this paper, project “FLY Croatia” will be presented, project with the of enhancing the development of aviation tourism in Croatia. The main emphasis in the paper will be given to an overview of the current state of Croatian airfields. Studies assessing the state of three existing airfields: Osijek-Čepin, Pokrovnik and Vis as the potential for its reconstruction will be also presented.

*Keywords: FLY Croatia, airfield, airfield study, general aviation, tourism*

### 1 Introduction

With an exceptional number of natural beauties on a relatively limited territory and with favourable climate conditions, Croatia has the potential of being the one of the most competitive countries on the European Union aviation tourism market. However, similar to potential of nautical tourism which was unexplored until the construction of ACI marinas in the 80s, aviation tourism is insufficiently exploited branch of tourism in Croatia. If we compare airports (Zagreb, Dubrovnik, Split, Osijek, Rijeka, etc.) in which classic passenger aircrafts are operated, with ports that handles large cruisers, then the potential network of airfields can be compared with the ACI marina network.

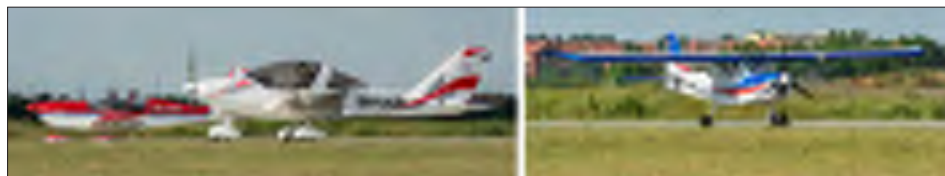
The potential for the development of aviation tourism is reflected in the considerable number of private, sport aircrafts and pilots and the fact that Croatia can be reached by a general aviation aircraft from any European destination in few hours’ time and up to two stopovers. According to available data presented in Table 1, within our region there is great aviation tourism potential reflected in number of private general aviation aircrafts, as well as registered general aviation pilots.



**Table 1** Number of licensed pilots and general aviation aircrafts in surrounding countries [1]

Country	Licensed Civil Pilots	Active General Aviation Aircrafts
Germany	87 894	20 687
Austria	3 000	893
France	41 000	2 800
Poland	4 030	907
Slovenia	2 500	144
Spain	2 500	4 500
<b>Total:</b>	<b>140 924</b>	<b>29 931</b>

Within 3 hours of flight time, a small, single-engine general aviation aircraft can cover a distance radius of about 1 000 kilometres, and the average number of passengers in these planes is 2-4 persons. Beside classic vacation periods, private aircraft allows for shorter weekend breaks in distant destinations, which is very difficult to achieve by a classic land transport. Favourable weather and climate conditions in Croatia enable prolongation of the aviation tourism season to almost all year round. Aviation tourism involves service offers for guest aviators who use private or club-owned general aviation aircraft for the arrival / departure or sports activity. General aviation include commercial, private or training flying by sailplanes (hang-glider and paraglider), skydiving aircraft, ultralight aircraft, as well as kit-built (so called experimental) crafts for recreational flying. The category of general aviation planes (Figure 1) includes all single-engine or two-engine minor piston and turboprop aircraft. The most recognised manufacturers are Cessna, Piper, Cirrus Design, Diamond, Mooney, and Beechcraft.



**Figure 1** General aviation aircrafts

Although somewhat similar, the concept of aviation tourism is essentially different from the well-known concept of fly-in community or Airpark. Fly-in community or Airpark refer to a community specifically designed around an airport and features one or more runways with homes adjacent to the runway. Within this concept, each resident would own their own airplane and park it in their own hangar usually attached to the home or integrated into their home. This parks are usually privately owned and restricted to use by the property owners and their invited guests and do not include commercial businesses. A large number of such settlements are organized in the United States (Figure 2).



**Figure 2** Fly-in community in the USA [2]

The concept of aviation tourism does not include the construction and sale of real estate (such as the concept of Airparks), only the construction of infrastructure necessary for the reception

of the guests, secure parking for general aviation aircrafts and smooth running of flight preparation and operation (i.e. briefing rooms). This means that the potential for development of aviation tourism in Croatia is already available and lies in all locations wherever airfields exist or may soon be revived.

The potential for aviation tourism and needed infrastructure development has been identified in the project FLY Croatia, Croatian aviation tourism program. Within the project, the ground idea for aviation tourism development in Croatia is based on the activation of existing (abandoned or underused) airfields and construction of the first specialized aviation tourist resort in Šepurine airport near the city of Zadar (base airport). Šepurine as a former military airport, although today abandoned and completely devastated, poses the existing runway and accompanying facilities. It is located at the central position of the Croatian territory, and all other airfields are quickly and easily accessible (Figure 3). Another very important determination in the development of aviation tourism is the fact that this is an area with a pleasant medium-Mediterranean climate and area with the least foggy days a year. This resort would serve as a starting-point from where incoming tourists will be able to travel by their private airplanes, rent-a-car vehicles or charter vessels, all over Croatia and visit our cultural and natural heritage through an organized system of tourist and sports trips. The network of existing airfields in Croatia is shown in Figure 3.



**Figure 3** Croatian airfields map and Šepurine – the base airport

Although there are runways of sufficient length (more than 600 m) at all existing airfields, only few of them have modern pavement (asphalt) and supporting infrastructure is generally poor or non-existent. In order to satisfy aviation regulations and increase tourism competitiveness, all these airports should standardize equipping and maintain to a specific technical level. Within this paper, possible reconstruction of 3 existing airfield will be presented in order to meet technical requirements for potential aviation tourism development.

## 2 Osijek-Čepin airfield

Airfield Osijek-Čepin is located 3 km south-west from the Osijek city centre. It was built in 1962 with unpaved (grassy) runway length of 1 200 m and the width of 60 m. The width of runway strip is 150 m. In order to accompany development of general aviation in East Croatia, but also to take over traffic from Klisa airport closed during the wartime, existing Osijek-Čepin airfield needed to be upgraded to a higher level of equipment and reconstructed. During 1995, the runway was paved; taxiway and apron were built, leading to existing port complex. After the war, Osijek Airport (Klisa) re-established operations and Čepin airfield is now used only for general aviation operation.

Osijek-Čepin airfield is equipped with two non-instrument runways, paved (asphalt) and unpaved (grass) (Figure 4). Paved runway is 1 200 m in length and width of 30 m, with runway end safety area (RESA) length of 30 m from the edge of runway strip. At both ends of the runway, there are turn pads length of 40 + 15 m and width of 15 m. Unpaved runway is also 1 200 m in length and the width of 45 m. Reference code of Osijek-Čepin airfield is B2, according to valid Airports regulation [3].



Figure 4 Osijek-Čepin airfield

Due to the fact that Osijek-Čepin airfield is intended only for recreational and sport activities of general aviation, all movement areas are intended for aircraft of apron (ramp) mass equal to or less than 5 700 kg. Thus the bearing strength of a pavement is defined as 5 700 kg/0,23 MPa. Osijek-Čepin airfield is listed as an aerodrome that has been permanently approved under the Article 74. of Air Traffic Act (Official Gazette no. 69/09, 84/11, 54/13, 127/13 and 92/14). Due to the good condition (Figure 5) of existing movement areas (paved and unpaved) defined and presented in study Proof of Čepin airfield movement areas state (Faculty of Civil Engineering Osijek, 2013), this airfield requires minimal investments in terms of supporting infrastructure modernization to comply with FLY Croatia project requirements.

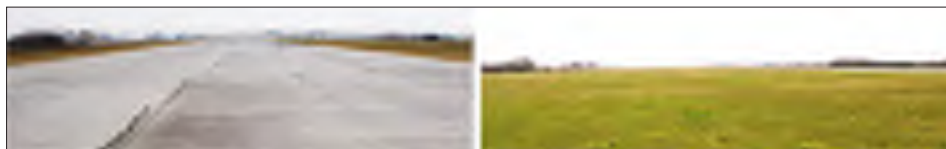


Figure 5 Osijek-Čepin paved and unpaved runway, current state

### 3 Pokrovnik airfield

The Airfield Pokrovnik is located along the state road D 33, about 20 km from the town of Šibenik which makes this location also very convenient for aviation tourism development. Current state of Pokrovnik airfield movement areas in terms of bearing strength of pavement and surface characteristics (evenness, friction) makes it unsuitable and unsafe for flight operations. Movement areas have macadam surfacing, poorly maintained, with low and medium-high vegetation along and on the runway (Figure 6). The length of the existing runway is approximately 1000 m and the width is approximately 30 m. Taxiway and apron is also in improper condition, similar to the runway. Position of existing taxiway and apron are at the half of the runway. The length of taxiway is approximately 100 m, and the width is approximately 15 m. The apron dimensions are approximately 55 m x 100 m.



Figure 6 Existing Pokrovnik airfield

The airfield is located at one cadastral parcel that was one of the limiting parameters for the determination of basic technical elements. Basic technical elements for Pokrovnik airfield reconstruction and modernization are selected in accordance with the valid Croatian regulations [4]. Due to optimal utilization of available space, airfield reference code is defined as B2. Antonov AN-2 (MTW = 5500 kg) was selected as the critical aircraft type. Instrument runway is designed with length of 840 m and width of 30 m, with RESA in length of 30 m from the edge of the runway strip. New position of apron is defined at the north threshold, in order to allow easier access to existing roads (Figure 7). Apron is designed with the dimensions of 100x70 m. The apron and the runway are connected by a taxiway with length of 75 m and width of 11 m.



Figure 7 Potential for Pokrovnik airfield modernization

Even though the current state of Pokrovnik airfield does not meet criteria for safe and comfortable flight operations, within short time and reasonable investment it could be brought to satisfactory state with possibility to build unpaved runway in the first stage, followed by future modernization into paved movement areas.

## 4 Vis airfield

The airfield Vis is located on the site of the former Second World War military airport (Figure 8). It is located along the state road D117, the only state road on the island of Vis which makes this location very convenient for tourism development.



**Figure 8** Potential for Vis airfield modernization

The length of the existing runway is about 1050 m and the width of approximately 60 m. Taxiway and apron are not constructed. Movement area of the existing airfield is in unfavourable condition, poorly maintained and neglected, with high vegetation. Vis airfield reconstruction is foreseen in two phases [5]. First, unpaved movement areas are to be constructed and after creation of favourable conditions, paved (asphalt) movement areas are to be constructed.

The main limiting parameter for airfield basic elements definition is cadastral parcel width of approximately 60 m at which existing airfield is located, but also some private cadastral parcels at the apron position. Before any reconstruction works, the ownership relations must be defined.

In accordance with valid regulations [3] and due to the available space, reference code of Vis airfield is defined as B1 while for critical aircraft type DHC6 Twin Otter Series 300 (maximal take-off weight (MTW) = 5600 kg) is selected. Non-instrumental runway, with the length of 799 meters, width of 30 m and RESA length of 30 m is foreseen. Runway strip is foreseen with the width of 60 m and the length of 859 m. At both ends of the runway, RESA is foreseen with length of 30 m and a width of 60 m. Apron is foreseen in the first third of the runway length connected to runway by taxiway with the length of 97 m and width of 11 m.

A prerequisite for the implementation of the second reconstruction phase is resolution of property and legal issues due to the need of increasing runway strip width. Within this phase, construction of paved movement areas is foreseen, as well as geometry correction due to the increasing traffic. Runway with the length of 1020 m and width of 30 m is foreseen, while runway strip is foreseen with the dimensions of 80 x 1140 m. Apron and taxiway would remain at the same position and with the same dimensions.

Due to the current state of Vis airfield movement areas (Figure 9), there is a need for significant reconstruction actions in order to fulfil standards and regulations for safe aviation operations. However, within two reconstruction phases and reasonable investments there is a huge potential for Vis airfield development into desirable aviation tourist destination.



Figure 9 Existing Vis airfield

## 5 Conclusions

Although Croatia has the potential to be one of the most competitive countries within the European Union aviation tourism market due to its territorial shape, natural beauties and favourable climate, this branch of tourism is almost non-existent. The potential for development of aviation tourism recognized within the project FLY Croatia, Croatian aviation tourism program lies in significant number of existing airfields. Although there are runways of sufficient length at all existing airfields, only a few of them have modern pavement (asphalt) and supporting infrastructure is generally poor or non-existent. In order to satisfy aviation regulations and increase tourism competitiveness, all these airports should standardize equipping and maintain to a specific technical level.

In this paper, three existing airfields are presented with different infrastructure quality. Based on the presented studies it can be concluded that within reasonable time and investments, many of the existing airfields could be modernized and developed into desirable aviation tourist destination.

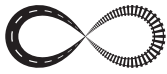
Finally, it is important to mention that after meeting the necessary technical requirements, all airports can be used as a multifunction unit for special purposes of strategic importance such as organization of air ambulance service or services for fire control. From the construction point of view, we can conclude that paving of only 20 km of runways can connect the entire country within itself, but also to the entire region.

## References

- [1] IAOPA Statistical Report – World Assembly, September 2014, [http://www.iaopa.org/doc/27th-World-Assembly-Documents-and-Presentations/misc-documents/IAOPA-Stats-2014\\_short-version-2.pdf](http://www.iaopa.org/doc/27th-World-Assembly-Documents-and-Presentations/misc-documents/IAOPA-Stats-2014_short-version-2.pdf), 1.2.2016.
- [2] The Spruce Creek Fly-in Community, <http://www.7fl6.com/>, 1.2.2016.
- [3] Official Gazette NN58/14, Airport regulations (in Croatian), 12.5.2014.
- [4] Barišić, I.: Study on reconstruction possibility of Pokrovnik airfield (in Croatian), Faculty of Civil Engineering Osijek, 2015.
- [5] Barišić, I.: Study on reconstruction possibility of Vis airfield (in Croatian), Faculty of Civil Engineering Osijek, 2015.







## LEVEES CONDITION ASSESSMENT IN CROATIA

Katarina Ravnjak<sup>1</sup>, Goran Grget<sup>1</sup>, Meho Saša Kovačević<sup>2</sup>

<sup>1</sup> Geokon-Zagreb, Zagreb, Croatia

<sup>2</sup> University of Zagreb, Faculty of Civil Engineering, Zagreb, Croatia

### Abstract

Levees are long linear structures where are often unavailable or insufficient data from the preliminary design to maintenance during exploitation and monitoring. Their importance is in the first place the protection of human life and material and other goods. In Croatian history the levees are almost always built when the need for flood defence or to improve the existing system of protection against adverse effects of water. Such actions are mainly implemented without the required geotechnical investigations, internal regulations and the prescribed monitoring of levees. But levees are not static structures as well as the high water level on which the levees are designed. In the Republic of Croatia in the last ten years extreme hydraulic phenomena are recorded which influenced the levees. Because of such construction conditions and the levee aging there is a need for serious systematization of levees state. Due to the impact, but also the significance of levees it is important to maintain them safe and therefore continue to implement monitoring. In this article monitoring through the assessment of the levees is proposed, whose basic idea is foundation and levee data collection. Negative effects on the levees and indicators that should be monitored and the importance of levee assessment and the guidelines and recommendations for the levee assessment implementation are described. Appropriate geotechnical investigations and monitoring provide the levees assessment and give the timely response due to the information of the possible collapse modes or levee deterioration. The systematic levee monitoring and the data obtained by geotechnical investigations, measurements, and even the very visual observation and the resulting levee assessment provides a great opportunity to use for the purpose of designing, building, construction and new levee exploitation.

*Keywords: levee, maintenance, levee condition assessment, monitoring, failures*

### 1 Introduction

The levees in Croatia were constructed without proper geotechnical investigations, standards and monitoring during exploitation but with known and accepted engineering practice. The reason for this practice was the fact that they were built at different times and in different economic circumstances, and almost always for the purpose of the current flood defense or to improve the existing flood protection system. Due to such construction conditions and the now old age there is a need for serious systematization of built hydraulic structures, especially of levees [1].

This paper aims to explain the importance of conducting levee monitoring, respectively the implementation of the new methodology for levee assessment in which indicators are recognized pointing to levee failure mechanism and makes suggestion on the frequency of conducting levee assessments.

As well as levees are ageing as the construction and a need for levee maintenance and remediation is constant, nowadays there are fewer funds for financing. By conducting levees



assessments, the routing of funds is enabled directly to those locations where it is really needed. By regular implementation of the levee assessment first of all the database of levees is created, which means easier monitoring of levees during the designed lifetime and by visual inspection changes are noticed timely. The results of such levee assessments, in the end, serve as a basis for decision-making for maintenance and on time remediation and in addition serves just for better understanding, help in management and reducing the risk of floods related with levees. All these are reasons why it should be considered and to accept new methods of monitoring and levee assessment.

This paper was partly created after a detailed study carried out in the basin area of the City of Zagreb. In Croatia, in fact, in the last decade floods occurred that have shown that levees are not absolutely secure and they can collapse due to the different situations. So the aim was to conduct a study and do technical documentation by which in the future unfavourable situations, like ones that happened before, will be prevented or reduced to a minimum. Although the conducted study is finished and was intended only for practical use, research is continued in particular in terms of safety and multiple criteria decision making and methodology and data collection.

## 2 Importance of levee assessment

Meteorological extremes in the area of upstream countries from Croatia recorded in 2010 formed a high water waves in the catchment area of the Neretva River, the Sava and the Danube, while large amounts of rainfall on the Croatian territory caused also the formation of high water of their affluent [2]. It was the flooding in September 2010 in the area downstream from the city of Zagreb that prompted the question of stability and security of built levees. Flood also started a series of dedicated measures for improvement of the built flood protection system with the purpose of reducing the flood risk to an acceptable level.

The importance of conducting levee assessment is in a monitoring, which is neglected when we talk about the levees in Croatia where there are neither regulations for the levee monitoring nor guidelines for the levees categorization. Joining the European Union, the Republic of Croatia committed to harmonize its regulations with a set of construction related standards, Structural Eurocodes. Today's information of levees in Croatia is based only on visual inspections and eventually on records in archives about anomalies during high water. For levees still there are no complete data on their heights. Of course in this situation there is also no data about foundation soil and soil that was used for building levees.

In many European countries there are standards for flood protection systems. In Germany and the Netherlands, standards have been augmented by national laws and regulations, while in the UK, investment in flood defense must meet the economic criteria in addition to prioritization criteria. In Poland, the local authorities are obliged to do levee assessment [3], because the majority of the levees are in their jurisdiction and that is regularly once a year and once every five years levee assessment includes investigations.

In the US and in the Netherlands, guidelines are prescribed to ensure levee safety. In these guidelines official checks are prescribed carried out by expert teams under the lead of key engineers with experience in investigations, design, construction and exploitation of levees. In the Netherlands, inspections or levee monitoring in order to evaluate the safety are mandatory by law. Levee assessment is carried out every five years and contains revision of the load, information on the building material and foundations, levee geometry and guidelines for the levee assessment, methods and criteria. U.S. Army Corps of Engineers (USACE) with the program for the safety of the levees aims to provide a better understanding, control and to reduce the risk of flooding associated with levees, along with maintaining and updating a national database of levees. Inspections of the levees are routinely each year and periodically every five years, when there is importance beside inspection to update the database.

After more floods [4] that emerged in the last decade in the United States, France, and all over the world reviews and research have been made to develop methods to model the levee failure mechanism and to assess performance of levees [5]. From the data collected in visual inspection, geotechnical investigations and from historical data indicators are established that can assess the state of the levee and its functionality. The issue of the levee safety, the way it evaluates levee, as well as the issue of the areas protected by levees are very important [6]. The way that may help in the planning of the monitoring, maintenance and remediation of levees and dams is proposed by identifying indicators and failure mechanism to which the individual indicators can lead [7], [8], [9]. The application of a new approach to assess the risk of flooding caused by levee failure was tested, as well as the model for the levee assessment [10].

### 3 Failure mechanism and levee state indicators

The aim of the research is to develop a methodology that will provide levee assessment and the failure mechanism. This primarily means collecting data. Data is collected from the existing documents, detailed visual inspections, investigation activities, in-situ and laboratory tests and numerical analysis. Data collected in that way are also the indicators that describe the state of the levee and possible failure mechanism. Visual inspection is preceded by collecting existing data and land surveying. The purpose of the visual inspection is to detect indicators that can affect the levee safety. Inspection includes the levee crest, waterside and hinterland slope and inundations and every anomaly is recorded. This is followed by preliminary investigations which include field and laboratory investigation works and serves for preliminary analysis. Detailed investigations are carried out in places where it is necessary to further investigate or where there is insufficient data. Assessment is carried out on the basis of the analysis of all data collected.

The basic idea of levee assessment is to collect data of foundation and levee. Investigations in this case enable exactly that, insights of the possible failure mechanism or deterioration of the levee performance. Adequate investigations and monitoring allows assessment of these conditions and give the possibility to react on time.

Otherwise, levees can come in five states that can cause the collapse. Each of the failure mechanism consists of several components and these components are registered by the indicators. Failure mechanism and indicators of each states are 1) overtopping, which represents the flow of water over the levee crest. The indicator of this condition is insufficient height of levees or levee is lower than the designed height, there is insufficient freeboard in relation to the high water or levee was lowered in relation to the design. 2) Erosion or any mechanism of erosion, internal or surface erosion, which threatens the integrity of the levee and leads to destruction. It can occur in the foundation or in the levee on the waterside or landside slope. It can be caused by high water, the fast water receding, changing the rainy and dry periods, wind, animals and human activity etc. Indicators of this failure mechanism are the surface material loss or lack of surface material and the movement of materials that includes sliding only the levee material (depressions, bulging, gullies, sliding) and movement of materials that includes sliding material from levee and foundation soil. 3) Seepage and internal erosion, moving soil particles and sand boiling due to the flow of water from the levee or out of the subsoil. Internal erosion can be caused by high seepage velocities or seepage through permeable soils. Indicators of this condition in levees are changes in vegetation, flow (constant or variable, clear or muddy) and loss of material, hydraulic instability. Figure 1 is showing the seepage through levee and foundation soil. 4) Sliding of a certain levee volume and / or foundation soil, moving along the sliding surface.



**Figure 1** Seepage through an levee and foundation soil

Deep sliding surface may be caused by the levee upgrade. Shallow shearing on waterside or landside slope are the most common caused by pore water pressure increase, loss of soil strength due to equalization of pore pressures or due to erosion of levee toe on waterside. Translational sliding may be caused by large hydraulic forces at the contact of the foundation ground and the levee or due to drying of organic material in levee, which means reducing the weight and shear strength. It can also be caused by human activity when upgrading the levee or by liquefaction due to large seismic loads. 5) Settlement or compacting of levee material and foundation soil under self-weight or the levee weight. It may be the result of human activities due to levee upgrading, seepage, internal erosion in subsoil and as consolidation settlement.

#### **4 Levee assessment objective**

The objective of levee assessments or procedures that includes assessment is the permanent insight into the levee condition and the surrounding soil in terms of stability, permeability, and other actions on mechanical resistance and stability. By conducting the levee assessment all events and conditions that could affect the levee safety and the surrounding area can be timely notice and register. It has the purpose of determining whether the levee behaviour is in the normal range, or if there are deformations that could be a sign of disturbance in the structure, the foundations or nearby area. Next very important reason for conducting the levee assessment is the rational maintenance. Levee reconstruction is very delicate and expensive, and therefore, there is a need that all the damage and side effects are timely detected and solved while not yet acquired a larger scale. Figure 2 is showing the suggested guidelines for frequency of levee assessment.

The objective is both economic and maintenance which means long-term stability, security and sustainability. Maintenance costs and status of the construction are strongly linked. In order to achieve constant construction state maintenance costs are necessary. If the construction maintenance costs are low the construction itself becomes useless. In order to avoid the complete construction destruction in the late time point huge maintenance costs are necessary.

As well as the monitoring can promptly identify and register all the events and conditions that could impact the safety and surrounding area for what the monitoring is really important is the rational maintenance. Remediation of these structures is very expensive and it is important to identify and remove any damage in time.

Therefore, levee assessment, except that is a good measure for the levee condition also is important information on the planned long-term funding for the levee reconstruction. In order to obtain an overview of the levee behaviour it is appropriate to apply the full range of monitoring and technical and seismic monitoring hydrological and hydraulic monitoring. The levee

assessment is of great importance of collecting experience in order to improve the levee design and construction. The systematic levee monitoring that are in exploitation and the data obtained by investigations, measurements, and even a single visual observation, provides a great opportunity to be used for the purpose of designing, building and construction and exploitation of new levees.

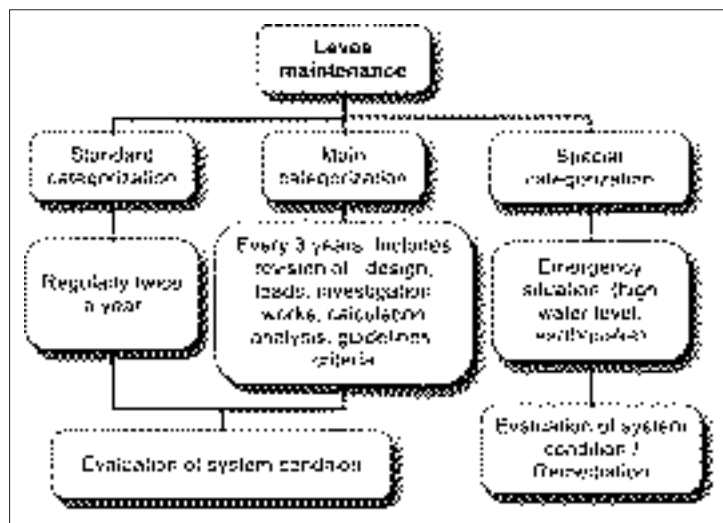


Figure 2 Guidelines for frequency of levee assessment [1]

## 5 Guidelines for the levee assessment

In order to ensure the proper levee functions during high water, for which the levee is designed caution, is needed. Levees are exposed to various actions and for that reason they need to be monitored. In addition, it is important to check whether the levee is maintained, as required, and provide all necessary information and all of the collected information, it is important to save. As the levees are linear structures geographical positioning data is important. Documentation on the levee assessment should be arranged and conducted in order to provide at all times a constant and complete overview of the levee. That includes a collection of all documents that are showing the actual levee performance and the overall levee assessment, the basis for the implementation of the results, as well as a collection of documents during the levee life time which are showing the levee condition set out by levee assessment. Levee dossier should look like and be based on the recommendations for the dam dossiers “Rules for the monitoring of large dams” [11].

Given that the part of the data is collected by visual inspection the water management patrol is one of the main to collect levee data. For this purpose, a method for training the water management patrol for the levee inspection is developed and in the near future the training should be carried out. Figure 3 is showing the investigation types of levee inspections by water management patrol. In this way the water management patrol will be trained which events, conditions or phenomena to be noted, how to write down the same, take photos and mark them on the locations and which are the further actions. The levee check list for the water management patrol is prepared. During the levee inspection the list of levee inspection should be complete. Taking into consideration the ratings given to certain levee elements it is possible to determine the final levee assessment. The state of each element is defined by the following assess.

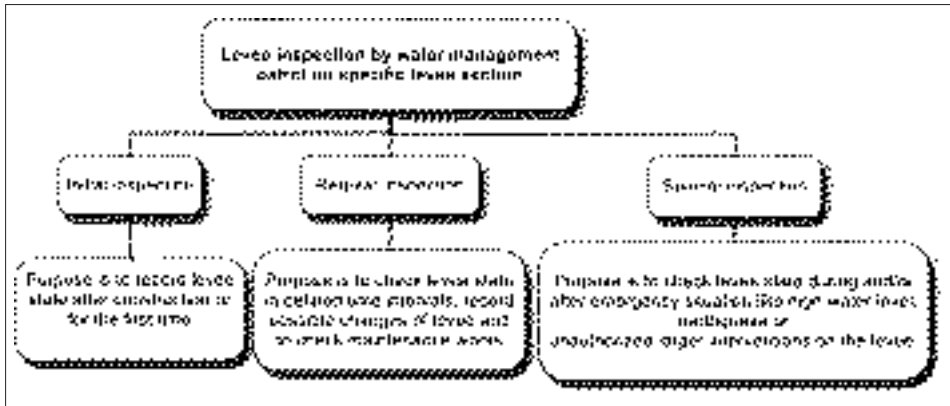


Figure 3 Types of levee inspection by water management patrol

After the initial, regular and special inspection by water management patrol, a report should be done. Report must include all materials and lists used when performing the levee inspection, levee photos, and especially photos showing the state of the levee and levee irregularities, site display with the markings of the locations evaluated as bad. It is necessary to state all the information on maintenance, indicate those which are carried out, which are running and the one to be performed. If the whole levee system is rated as acceptable in the report need to be specified which locations should be restored first in order to get the good levee condition and functionality.

Given the huge amount of data that should be kept for the levee lifetime GIS digital platform should be developed in which levee data are connected and available through geo-referenced platform. GIS would also enable faster access to information, more views on folders and thus to speed up the execution of necessary actions [6]. GIS will contribute to obtain a spatial decision support system aiding levee managers in their maintenance decision [5]. The main benefit of implementing a GIS dedicated to the management of flood protection dikes is obviously the preservation of information for the future [10].

## 6 Conclusion

Levees maintenance carries a lot of questions and a lot of decisions when it comes to levee reconstruction or just maintenance. Conducting the levee condition assessment helps in decision-making and defining priorities, suggesting a specific problem related to the levee condition and eliminates the effects of minor importance.

The main reason for conducting the levee condition assessment is primarily the population protection and the protection of material goods. It has the purpose of determining whether the behaviour of the levee is in the normal range, or whether there has been a phenomenon that could be a sign of disturbance in the levee, foundation soil or nearby area. As well as rational levee maintenance.

Levee reconstruction is very sensitive and expensive and there is a need that all damages and side effects are timely detected and solved while not yet acquired a larger scale. Since there are no national standards or legislations this paper provides guidance for levee condition assessment emphasizing the importance of using the same.

## Reference

- [1] Ravnak, K., Juriša, Z.: Stability analysis of existing river Sava levees in order to define their security in the field of water management department, Proceedings of the 6th Croatian Water Conference with International Participation, Opatija, pp. 719-728, 2015.
- [2] Đuroković, Z., Biondić, D., Sitar, S.: Floods and flood protection in the Republic of Croatia and the role and significance of headquarters for flood control, Proceedings of the Flood in Croatia (Editorial – Biondić, D., Holjević, D.), Croatian Waters, Vukovar, pp. 9-22, 2012 (in Croatian).
- [3] Mydlikowski, R., Beziuk, G.: Examination of levee condition by means of GPR, *Studia Geotechnica et Mechanica*, XXXI (4), pp. 49-56, 2009.
- [4] Sills, G.L., Vroman, N.D., Wahl, R.E., Schwanz, N.T.: Overview of New Orleans Levee Failures: Lessons Learned and Their Impact on National Levee Design and Assessment, *J. Geotech. and Geoenviron. Engrg.*, ASCE, 134(5), pp. 556–565, 2008.
- [5] Serre, D., Peyras, L., Tourment, R., Diab, Y.: Levee Performance Assessment Methods Integrated in a GIS to Support Planning Maintenance Actions, *J. Infrastruct. Syst.*, 14(3), pp. 201–213, 2008.
- [6] Maurel, P., Serre, D., Tourment, R.: Towards a Generic GIS for Dike Management in Flood Plain Areas: from Conceptual Design to Real Applications, 7th AGILE Conference on Geographic Information Science 2004, pp. 73-81, 2004.
- [7] Curt, C., Peyras, L., Boisser, D.: A Knowledge Formalization and Aggregation-Based Method for the Assessment of Dam Performance, *Computer-Aided Civil and Infrastructure Engineering*, 25(2010), pp. 171–183, 2010.
- [8] Curt, C., Talon, A., Mauris, G.: A Dam Assessment Support System Based on Physical Measurements, Sensory Evaluations and Expert Judgements, *Measurement*, 44(1), pp. 192–201, 2011.
- [9] Vorogushyn, S., Merz, B., Lindenschmidt, K.E., Apel, H.: A New Methodology for Flood Hazard Assessment Considering Dike Breaches, *Water Resources Research*, 46, 2010.
- [10] Vuillet, M., Peyras, L., Carvajal, C., Serre, D., Diab, Y.: Levee Performance Evaluation Based on Subjective Probabilities, *European Journal of Environmental and Civil Engineering*, 17 (5), pp. 329-349, 2013.
- [11] Rules for the monitoring of high dams (Sl. list 128/1966. NN 53/91)





## NEW RAILWAYS IN THE TRIESTE-KOPER AREA

Marko Jelenc, Andrej Jan

*PNZ svetovanje projektiranje d.o.o., Ljubljana, Slovenia*

### Abstract

The railway axis Lyon – Trieste – Divača (Koper) – Ljubljana – Budapest – border between Hungary and Ukraine which presents the eastern half of the Mediterranean Corridor as determined by the European Commission with the New EU Transport Infrastructure Policy of 17 October 2013 is to be established. The European Commission highlighted two key railway projects in the Mediterranean Corridor, namely the connection between Lyon and Torino and the railway link Venice – Ljubljana, part of which is also the cross-border section Trieste – Divača between Italy and Slovenia, divided into Italian and Slovenian parts. For the Slovenian part, the company PNZ d.o.o. from Ljubljana created a preliminary design in 2014. The article presents the development of project solutions, starting points for design, and technical solutions of the project. The railway infrastructure, which is the object of this preliminary design, consists of four parts: the first one concerns the basic outline of the Mediterranean Corridor, and the other three provide connection of this section to the existing railway infrastructure in the area of Divača. The first part features a high-function double track for mixed traffic (passenger and freight transport) in the length of 10.9 km. The second part includes the west part of the railway node of Divača enabling connection of trains from the Port of Koper to the basic route. The third part features a presentation of the main railway line No. 50 Ljubljana – Sežana – state border with Italy in the length of 1,224 m. The fourth part presents the 394 m long connecting axis Koper – Sežana. There are many facilities on the route, the biggest of which is the cross-border tunnel Lanaro/Volnik with length of 15,084 m (length of the Slovenian part 3,825 m). Furthermore, a 3D visualisation has been prepared in order to present the project to the general public.

This link represents the first part of a high-function railway line enabling speeds up to 250 km/h in Slovenia. During the design phase, a new comprehensive settlement of the hub of Divača has been considered, which enables a complete connection of freight traffic from the Port of Koper along the railway line Koper – Divača (the first existing track and the planned second track) to the new railway line Venice – Ljubljana. Besides the preliminary design, the article presents also a broader conceptual framework of the possible development of railway infrastructure in the area of Trieste and Koper and in the direction of Ljubljana.

### 1 Introduction

The railway axis Lyon-Turin-Trieste-Divača (Koper)-Ljubljana-Budapest-border between Hungary and Ukraine which presents the eastern half of the Mediterranean Corridor as determined by the European Commission with the New EU Transport Infrastructure Policy of 17 October 2013 and connects the Iberian Peninsula with the Hungary-Ukraine border is to be established. The Corridor runs along the Adriatic coast of Spain and France, crosses the Alps towards the East across Italy, and heads through Slovenia and Croatia towards Hungary. The European Commission highlighted two key railway projects in this Corridor, namely the connection between Lyon and Torino and the railway link Venice – Ljubljana, part of which is also the cross-border link Trieste – Divača (marked in red on Figure 1).





Figure 1 Mediterranean Corridor between Lyon and Budapest and the cross-border part Trieste – Divača (red).

## 2 New railway line Trieste – Divača

The route of the cross-border section (CBS) of the new railway line (NRL) Trieste – Divača was chosen as the most suitable one from spatial and environmental points of view in cooperation with Italian and Slovenian experts and confirmed at the 6th session of the inter-governmental Slovenian and Italian commission for this railway connection of 3 July 2012.



Figure 2 Connection lines to the Mediterranean Corridor in the area of Trieste and Koper.

The CBS starts in Aurisina, Italy, where the connecting track for Trieste is planned and ends in Divača, Slovenia, where the connecting (second) track for Koper is planned. The Italian part of CBS is over 12 km long, great part of which is located in a tunnel. In Aurisina, right after the connection of the linking route for Trieste, the line passes into the over 15 km long tunnel of La-

naro/Volnik. The Slovenian part of the tunnel is 3,825 km long. The Slovenian part of the CBS is 10.9 km long and runs mainly on the surface parallel to the motorway A3 Gabrk-Fernetiči. Last, the form of connection to the existing railway network at Divača was determined by considering the long-term design of the Divača hub as the junction point of the existing (conventional railway line Ljubljana – Sežana and the first track Divača – Koper) and planned railway lines (high speed rail (HSR) Venice – Ljubljana and the second track Divača – Koper). In February 2015, the Ministry of Infrastructure of the Republic of Slovenia ordered the preparation of the preliminary design with the title “New Railway Axis Trieste – Divača (Slovenian part of the section)” by the company PNZ d.o.o. from Ljubljana under the project number 12-1479 co-financed by the EU Fund for Development of Trans-European Transport Networks TEN-T [1].

## 2.1 Technical characteristics

Technical characteristics were coordinated with designers of the Italian part of the CBS Trieste – Divača. The design speeds on the NRL are 250 km/h for passenger trains and 100 km/h for freight trains and 70 or 80 km/h on the connecting tracks to the existing railway. The distance between track centres is 4.20 m or more (consequence of separating both pipes of the tunnel Lanaro/Volnik and the needs of placing double-track connections). The highest allowed axle load is 25 t or 8.8 t/m.

The NRL route Trieste – Divača starts with a branch line on the new railway Ronchi – Trieste near Aurisina in Italy. The route passes the state border approx. 1.6 km north-west from the existing road border crossing Fernetiči.

At this point, the NRL Trieste – Divača runs in a curve deep under the surface in the tunnel Lanaro/Volnik, which is the biggest facility on the route. Total length of the tunnel stretching in Slovenia and Italy is 14,996 m. Nominal length of the Slovenian part of the tunnel is 3,825 m. It is to be created with two one-track pipes. Both pipes are connected with beams separated 500 m from each other.

The NRL route crosses the motorway A3 Gabrk – Fernetiči, the regional railway Jesenice – Sežana and the regional road R1-204 Šempeter – Sežana under the surface.

Then, the NRL route comes out of the tunnel east of Sežana and runs towards the East on the surface, it crosses the regional road R2-445 Senožeče – Fernetiči and then runs south of the motorway A3 Divača – Sežana – Fernetiči.

Before the village of Žirje, it passes into a deep cut leading to a 260.5 m long cut-cover which protects the village of Žirje from the impacts of the railway traffic. The cut-cover continues to the cut under the hill of Gabričje. After the cut, the NRL – that runs along the motorway at a distance of 20 m and more – moves towards the south to avoid the road service area Povir.

In the area between Gorenje pri Divači and Divača, a connection to the existing railway line No. 50 Ljubljana – Sežana – state border, featuring two tracks outside the level is planned. Both connecting tracks outside the level enable continuation of the NRL in the direction towards Ljubljana.

Rail profile 60 E1 are to be installed. During installation, provisions of the TSI INF HS should be considered. 2.60 m long concrete sleepers are to be installed at distance of 60 cm. Because there are no regulations for railways with speeds of 250 km/h in Slovenia, the minimal thickness of the ballast bed on the NRL is 35 cm in accordance with German guidelines for high speeds (Ril 820.2010). 19 standard 60 E1 switches and 8 track bumpers – two of which (at the end of the route which is to be continued towards Ljubljana) are temporary – are to be installed.

In the area where the tracks will be connected to the existing railway infrastructure, the dimensions of track elements are adapted and some additional appliances are used (for rail lubrication, for increasing the side resistance).

In the cuts, the minimal width of longitudinal ditch is 40 cm and are located at least 1.0 m under the ballast bed. Due to safety regulations, the width of ditches in deep cuttings amounts

to 3.0 m. Water flows into water draining ditches placed especially in the existing Karst sinkholes or karstified areas with a high water sinking coefficient. 23 water sinks are planned. Due to safety regulations for emergency cases and according to the German regulations determining requirements for planning the railway infrastructure for the cases of fire or other disasters, accesses to the NRL are planned – one access on every 1,000 m.

Due to environmental requirements, a wire guard fence preventing driving over animals is planned in the area between the east portal of the tunnel Lanaro/Volnik and the west portal of the cut-cover Žirje.

Because of the NRL, 24 existing roads of various categories in the total length of 7.75 km must be re-located. Due to crossing of the NRL with roads and the splitting track and in order to protect the settlement from negative impacts, 10 construction elements are planned: 5 underpasses, 3 overpasses, 1 cut-cover with the length of 260.5 m (at the village of Žirje) and one 160.5 m long cross facility (crossing of the splitting track with NRL in the direction towards Ljubljana).

In order to protect the environment from noise, several noise barriers and dykes as well as installation of absorption coverings at the portals of the tunnel Lanaro/Volnik and the cut-cover Žirje are planned.

Because of building the NRL and associated infrastructure, public infrastructure lines (electricity power lines, telecommunication lines, water supply lines, waste water lines, the planned pipeline M6 Ajdovščina – Lucija) need to be appropriately protected or rearranged and two housings need to be demolished.

At the NRL route, all stable electric traction devices need to be installed. The system 2 x 25 kV, AC, and the existing 3 kV DC traction system on connecting tracks are selected, respectively. Telecommunication system on NRL is designed to be compatible with the existing system of Slovenske železnice and to meet the inter-operability requirements.

NRL is to be arranged as a double track for mixed traffic with the possibility of reverse traffic on both tracks. The key requirement is the installation of the ERTMS/ETCS for conducting, management, and signalling traffic.

The alignment of such an important route must be coordinated with interests of wider community and interests of local inhabitants and plot owners who are most affected by searching the location for such a route. In order to present the planned arrangements as explicitly as possible, a visualisation has been prepared for this segment.



**Figure 3** Situation and longitudinal profile of the cross-border section of the NRL Trieste – Divača.

### 3 New railways in Trieste area

In 2014, the project ADRIA-A, which was included in the operative programme of the cross-border cooperation between Italy and Slovenia was concluded. The project area included Italian provinces from Ferrara to Trieste and West Slovenia. One of the key goals of the ADRIA-A project was the establishment of missing links between the states and, in particular, the establishment of the Trieste rail ring running between Nova Gorica and Koper on two routes (Figure 4), namely:

- 1) east ring part: from Nova Gorica along the existing railways through Štanjel, Sežana, Divača to Koper, and
- 2) west ring part: from Nova Gorica through Gorizia to Ronchi, where an intermodal passenger logistic centre is planned for the area of Udine, Gorizia and Nova Gorica, Trieste, Istria (population over 1 million) connecting the Ronchi International Airport, a railway station on local railways, a station on the HSR Venice – Ljubljana and a bus station. From this logistic centre, the west ring part continues towards Trieste and to Koper. At this point, a connection between Aquilinia and Koper is missing, namely, a CBS of light railway Trieste-Koper.



**Figure 4** Trieste rail ring (blue and green), high speed rail (HSR) Venice-Ljubljana (yellow) and the missing connection between Trieste/Aquilinia and Koper (red).

In October 2014, the Ministry of Infrastructure of the Republic of Slovenia ordered the preparation of the conceptual design and feasibility study with the title “Light Railway Trieste – Koper” by the company PNZ d.o.o. from Ljubljana under the project number 12-1500 co-financed by the EU Fund for Cross-border Cooperation between Slovenia and Italy [2]. The route is divided into three segments:

- 1) New railway from the state border to Bertoki next to motorway Srmin – Škofije (4.75 km)
- 2) Existing infrastructure between Bertoki and Koper – potniška station (length of 2.55 km);
- 3) Tramway town route to the border with the Municipality of Izola (length of 5.75 km).

A tram-train is planned to run along the Trieste rail ring enabling driving along tram lines (R25) and along conventional railways (100 km/h)

## 4 Conclusion

The article presents the section of the new railway Trieste – Divača and the possible development of the railway infrastructure in the area of Trieste and Koper. The section Trieste – Divača is part of the HSR Venice – Ljubljana determined to be one of the two key railway projects on the Mediterranean Corridor (besides the connection Lyon -Turin) of the European Network TEN-T by the European Commission. In the wider area of Trieste and Koper, the Trieste rail ring, one of the key goals of the ADRIA-A project, is presented.

The establishment of the HSR Venice – Ljubljana is important not only because of bigger freight traffic capacities, but also because of time sparing in passenger traffic – the travelling time would decrease to less than 1/3 of the train travel and to 1/2 of the car travel.

Unfortunately, the latest findings suggest that in the next decades (until 2030 or even 2050) there will not be enough traffic to justify the building of the HSR. The author personally believes that such projects should be implemented in order to create a unified European economic, cultural and social environment and to promote sustainable development, thus drawing nearer other overseas environments in Asia, North and South America and Africa.

## References

- [1] PNZ, d.o.o., železniški koridor: Lyon-Trst-Divača (Koper)-Ljubljana-Budimpešta-madžarsko-ukrajinska meja; železniška proga: Benetke-Ljubljana; Nova železniška proga Trst – Divača (slovenski del odseka), Preliminary design, Ljubljana, 2015.
- [2] PNZ, d.o.o., Lahka železnica Trst – Koper, Feasibility study (Conceptual design), Ljubljana, 2014.



## USE OF SPIRAL STEEL PIPES DURING CONSTRUCTION OF SOUTHERN BYPASS FOR DONJI MIHOLJAC

Hrvoje Pandžić<sup>1</sup>, Adam Czerepak<sup>2</sup>, Mario Bogdan<sup>3</sup>

<sup>1</sup> *Agenor d.o.o., Osijek, Croatia*

<sup>2</sup> *ViaConSp. z o.o., Rydzyna, Poland*

<sup>3</sup> *Protekta d.o.o., Đakovo, Croatia*

### Abstract

The technology of construction and rehabilitation of culverts using spiral steel pipes has been only sporadically applied in our region, and is often referred to as a “new” technology, although it dates back to the second half of the 19<sup>th</sup> century. According to design work based on long-standing experience gained on the worldwide and European scale, and based on fifteen years of experience acquired in Croatia, this technology was applied in the design documents by the designers and in construction work by the contractor in the scope of the project involving construction of the southern bypass for the town of Donji Miholjac – Phase II. This paper describes experience gained and procedures applied during working design of spiral steel pipes, and during assembly and construction of these pipes. Advantages in their use as compared to “old” conventional culvert construction methods are also presented.

*Keywords: spiral steel pipes, culverts, construction technology, design, experience, advantages*

### 1 Introduction

This professional paper describes the culvert and passage building technology involving the use of HelCor and Multi Plate spiral steel pipes during the second phase of the southern bypass construction for the town of Donji Miholjac.

The town of Donji Miholjac lies in the north-eastern part of the Republic of Croatia along the Drava River at the border with the Republic of Hungary. A total of 10,265 residents live in the town of Donji Miholjac, which is made of seven local communities. The zone in which the town of Donji Miholjac is situated is mostly characterized by a low-lying area (95-97 m a.s.l.), by the Drava River and its tributaries, and by several lakes along the northern border with the Republic of Hungary, and the Karašić River in the southern and south-western part of the municipality [1].

The section under study is 3,544.87 m in length. The route begins at the existing national road D34, to the west of the entrance to the town of Donji Miholjac, and ends at the new roundabout situated at the national road D53. The roundabout is also the starting point of the route of the previously built first phase of the southern bypass of the town of Donji Miholjac [1], Figure 1.





Figure 1 General layout of southern bypass of the town of D. Miholjac, Phase II [1]

## 2 Requirements for building southern bypass of the town of Donji Miholjac

### 2.1 Terms of reference

The Client Hrvatske ceste d.o.o and the designers (Institut IGH d.d., Projektni biro Palmotićeve 45 d.o.o. and Agenor d.o.o.) defined the terms of reference taking into account numerous problems that have been plaguing the town of Donji Miholjac for quite some time. The backbone of the town of Donji Miholjac is formed of two transport corridors that intersect one another at the very centre of the town. The first of these two corridors is the national road D53, which is the transverse route of eastern Croatia connecting the Sava and the Drava transport corridors, and the border crossing to the Republic of Hungary. The second corridor is the national road D34 which represents the longitudinal route of Eastern Croatia running along the Drava River toward the town of Osijek. Because of the mentioned problems, the need arose to build the Donji Miholjac bypass in the east-west direction, to the south of the town, the purpose being to move the Drava corridor through traffic away from the centre of Donji Miholjac.

A daily equivalent traffic load, expressed through the number of 82 kN axle passes, was obtained by analysing the data gathered at the traffic counting point No. 2403 (Donji Miholjac-East, D34). This traffic load belongs to the group of heavy traffic loads (according to HRN U.C4.010). The bypass route is situated about 300 m to the southwest of the first and second water protection zones defined for the water supply well “Donji Miholjac Well Field”. In addition, the entire route runs through the third sanitary water well protection zone. In order to safeguard the quality of drinking water coming from the above mentioned water supply well, appropriate protection measures were planned for a high-level maintenance of the system for evacuation of water from the said road section during the service life of the road. The zone traversed by the route is agricultural in character, it is undeveloped and intersected with drainage canals and field paths that are used to gain access to the existing plots. The watercourses running toward the north and the Drava River will be cut off by construction of the Donji Miholjac southern bypass, which is why it was necessary to plan construction of culverts through the roadbed.

### 2.2 Advantages of using culverts made of spiral steel pipes

Advantages of culvert construction technology involving the use of spiral steel pipes at the Donji Miholjac southern bypass construction project have been proven from the standpoint

of their cost-effectiveness, technology and time savings, based on comparison of cost items and time schedules with the corresponding data from other culvert construction technologies, based on category proofs and standards compliant with the EU regulations, and based on fifteen years of experience in Croatia on various projects including [5-7]. Numerous clients, supervisory bodies and engineers, designers and contractors have successfully used spiral steel pipes in the design and construction of culverts in highly demanding conditions. In fact, that this road infrastructure construction technology has been adequately implemented for more than hundred and twenty years in many parts of the world, while it has been used for more than seventy years in Europe and also in Croatia, thanks to its proven low cost, short construction time until resumption of traffic, compliance with rules of professional practice, considerable bearing capacity under all load conditions for roads and railways for speeds up to 200 km/h, easy lengthening, easy rehabilitation and extension, flexibility of solutions, great choice of forms and spans – diameters, low weight of the pipe and structure, high level of corrosion protection, and design life of more than one hundred years.

### 3 Culvert design using HelCor® spiral steel pipes

#### 3.1 Selecting sheet geometry and thickness for HelCor® spiral steel pipes

Various longitudinal and cross-sectional culvert profile requirements have determined the geometry of culverts made of spiral steel pipes. Thus, the cross section and the bottom level are dictated by hydraulic elements and by water regulations, and so the following HelCor® spiral steel pipe types have been developed: DN 800, DN 1200, DN 1400, DN 1600 and DN 2000. The selection of various profiles has enabled considerable transport cost savings as up to 68 m HelCor® spiral steel pipes can be transported per a single track using the pipe “telescoping” (pipe-in-pipe) method, Figure 2.



Figure 2 Transport of HelCor® spiral steel pipes

The flexibility of solutions used, and especially a good coordination between the working design designer AGENORd.o.o. and contractor OSIJEK KOTEKS d.d., combined with technical assistance of HelCor® engineers, enabled maximum reduction in the number of pipe elements (Figures 2 and 3) per culvert. Thus the culvert length of over 30 m was realized using three pipe elements, and the maximum length of individual pipe elements amounted to 13.60 m. The Table 1 present specification of culverts used at the southern bypass of Donji Miholjac [2]. On Figure 4 we can see the on-site storage of HelCor® spiral steel pipes.



**Table 1** Specification of culverts used at the southern bypass of Donji Miholjac [2]

No.	Chainage (km)	Diameter Φ (mm)	Sheet diameter GP? (mm)	Sheet thickness IP? (mm)	Over- burden h (m)	Intersec- tion angle ? (°)	Length in axis Lo (m')	Total length Lu (m')	No. of cou- plings
1	0+247,88	80	2	2	1,04		22,40	22,45	1
2	0+669,24	120	2,5	2	1,05		9,20	10,15	
	0+669,24	120	2,5	2	1,68		14,93	15,51	1
	0+669,24	120	2,5	2	1,05		10,36	10,50	
3	0+827,82	160	2,5	2	1,50		31,24	34,38	3
4	1+060,00	120	2,5	2	1,62		30,76	30,76	3
5	1+100,00	120	2,5	2	1,23		30,95	30,95	3
6	1+349,25	200	2,5/3,5	2,5	2,10		22,99	24,57	2
	1+349,26	200	2,5/3,5	2,5	0,31*		9,37	9,82	
7	1+712,16	120	2,5	2	1,93		18,03	18,73	1
8	1+999,48	160	2,5	2	1,94		15,79	16,33	1
9	2+428,42	140	2,5	2	0,74		15,57	16,26	1
10	2+446,47	200	2,5/3,5	2,5	0,81		15,98	16,98	1
	2+446,48	160	2,5	2	0,20*		7,96	7,96	
11	1+543,00	80	2	1,5	0,34*		30,08	30,08	3
12	Ratkovci I	120	2,5	2	0,00		14,06	14,86	1
13	Panjik	120	2,5	2	0,00		13,65	14,05	1
14	Đanovci I	140	2,5	2	0,00		13,95	14,75	1
15	%	40	2	2	0,00		%	%	%
16	%	40	2	2	0,00		%	%	%
Total		40			16		%	%	%
		80	Cost estimate Detailed design	New Working design	55	According to design	52,48	52,53	4
		120			150		141,94	145,51	10
		140			31		29,52	31,01	2
		160			60		54,99	58,67	7
	200	55			48,34		51,37	3	
Total:	All Φ	Cost estimate	Cost estimate	367	According to design	327,27	339,09	26	



**Figure 3** Transport and unloading of HelCor® spiral steel pipes



**Figure 4** On-site storage of HelCor® spiral steel pipes

Static analysis of spiral steel pipe culverts, conducted separately for each pipe diameter, is an integral part of the working design. The sheet metal corrugation and thickness were selected based on load analysis according to EU categorisation and standards, and the decision was made to reduce the sheet metal thickness compared to specifications given in the detailed design, which resulted in additional savings.

In addition to the cost of the total structure, an additional advantage, which is by several times more favourable compared to all other technologies, is the rate at which the works can be carried out, [5], [6], and [7]. When selecting longitudinal geometry of the spiral steel pipe, and in addition to meeting the above mentioned requirements, it is also necessary to provide for: proper incorporation of pipe inlets and outlets into road embankment slopes [3], [5], vertical walls at culvert inlets and outlets, embankment and channel slope revetment, possible discharge of the channel or pipe drainage into the culvert, passage of infrastructure service ducts/installations, and possible additional pipe connections under the footways or other structures. The working design called for factory-made pipe inlets and outlets in form of a “mouth”, which follow the slope of embankment or are positioned at an angle with respect to the road axis.

## **4 Construction of culverts made of HelCor spiral steel pipes**

### **4.1 Assembly and backfilling**

Based on perfect coordination between the client, designers and supervising engineers, and thanks to technical assistance of the manufacturer’s engineers, and the contractor’s proper time scheduling, the unloading process constituted at the same time the assembly of individual spiral steel pipes onto the previously prepared bedding. In order to ensure perfect fit of the steel structure, the bottom base was covered with a gravel and sand layer approximately 20 cm in thickness. This layer thickness can be regarded as one of the smallest culvert bedding thicknesses applied on similar projects. The compaction in unfilled zones or “pockets” between the pipe and the bedding was conducted with due care using hand rammers and water. To backfill the unfilled space, it was necessary to provide a working area of 0,70 m on each side of the structure. In the immediate vicinity of the culvert backfilling zone, and especially in the zone of soil influence on the start of composite action of the structure, there should be no external forces (e.g. foundations), which often happens in case of rehabilitation or removal of non-functional RC culverts.



**Figure 5** Assembly of pipe with coupling, backfilling and wall construction



**Figure 6** Both-sided backfilling with compaction and construction of walls

The backfilling with compaction was conducted simultaneously from both sides of the pipe in uniform layers each 30 cm in thickness, along the entire width of the foundation pit, using light construction machines – vibratory tampers or vibratory plates (Figure 5 and 6). Time needed to connect pipes with couplings was negligible as this work was conducted simultaneously with the backfilling and compacting activities. It was possible to resume road traffic as soon as the level of 60 cm above the top of the pipe was reached [5], [6], and [9]. The construction of each spiral steel pipe culvert lasted two days, and the traffic could resume immediately after this activity. It is precisely this rapid construction rate that greatly facilitated on-site communication along the 3.5 km long route. This culvert construction activity was conducted simultaneously with construction of vertical walls, which was followed by slope improvement at pipe inlet and outlet zones (Figure 7).



**Figure 7** Culvert under traffic load during wall construction activities

## 4.2 Culverts in use

Eighteen culverts were built at the Donji Miholjac southern bypass using the culvert construction technology involving spiral steel pipes. Out of this total number, eleven culverts were built in the road bed and seven at parallel field paths (Figures 8, 9, and 10). The flexibility of solution regarding construction of inlet and outlet parts of culverts enabled designers to use various materials to speed up the construction work, to optimise the costs, and to blend harmoniously the culvert with the surrounding scenery. Maintenance is unnecessary for culverts built in accordance with the manufacturer's instructions, design requirements, and supervising engineer's instructions, Figure 11.



**Figure 8** Completed culvert at roundabout entrance (first phase of construction) during construction work



**Figure 9** Culverts in use in road bed and service road



**Figure 10** Culvert in road bed (HC 2000) and culvert in service road (HC 1600)



Figure 11 Completed culvert (CH 2000) in road bed during road use

## 5 Conclusion

Corrugated steel sheets were formerly dominantly used in the construction of culverts and passages by the countries with the developed steel industry and expensive labour [1]. Based on worldwide and European experience [9], and experience gained in Croatia [5], [6], [7], this construction technology is now increasingly being used in our country. One of examples of such use is the Donji Miholjac southern bypass project, which was completed in late 2015. Excellent coordination of all participants in this project, and experience and knowledge gained during realisation of the project, resulted in high quality of construction work and in significant advantages compared to “conventional” culvert construction procedures. In addition to culvert construction complying with rules of professional practice, most notable advantages include several times shorter construction time, flexibility of solution used, and considerable financial savings [5], [6], [7].

## References

- [1] Dragčević, V., Rukavina, T.: Donji ustroj prometnica, Građevinski fakultet, Sveučilište u Zagrebu, 2006.
- [2] Lukačić, V., Schwabe, Ž., Bleiziffer, J.: Glavni građevinski projekt GP – 1828/11, Institut IGH d.d., ožujak 2011.
- [3] Pandžić, H., Bilek, T.: Izvedbeni project, Agenor d.o.o., travanj 2015.
- [4] Bogdan, M.: Priručnik, tehnička svojstva i smjernice za gradnju, Protekta d.o.o., Zagreb, ViaCon Poljska, 2013.
- [5] Bogdan, M.: Zamjena dotrajalog mosta Požeška Koprivnica 4 novim mostom, Građevinar, 61, 2009.
- [6] Šimenić, D., Lukačević, D., Glavaš, T.: Modernizacija D38 na dionici Ruševo – Levanjska Varoš, Zbornik radova, 4. HR savjetovanje o održavanju cesta, HC, listopad 2009.
- [7] Bogdan, M.: Primjena čeličnih spiralnih cijevi HelCor® na sanaciji propusta u rekonstrukciji cesta na poplavljenom području uz rijeku Savu, Kongres o putevima Srbije, 2016.
- [8] Technical Data Sheet, [www.viacon.pl](http://www.viacon.pl)
- [9] Katalog HelCor®, <http://viacon.pl/en/download>



## ESTABLISHING THE CAPACITIES IN THE INNER CITY – SUBURBAN RAIL PASSENGER TRANSPORT

**Branimir Duvnjak, Tomislav Josip Mlinarić, Renato Humić**

*University of Zagreb, Faculty of Transport and Traffic Sciences, Zagreb, Croatia*

### Abstract

Required capacities are determined by the number of transported passengers, however, current practice of counting passenger by number of tickets sold or by manually counting the passenger in a given time period is neither reliable nor accurate. Use of IT technology is necessary for reliable and accurate counting of passengers. During the study of transport demand, the following component which are important for the analysis have been identified: a) number of transported passengers, b) utilization of the travel route and c) capacity utilization. Such research of demand for transport can be used for inner city-suburban and regional transport in order to precisely establish the share of subsidies which can be obtained by each of the transport modes, which can have a significant impact on the price of the ticket.

*Keywords: inner city, travel route, passengers, capacities, suburban rail*

### 1 Introduction

Total demand for transport capacities (Figure 1) depends on the quality of provided service. Demands of the transport users define the concept and development of transport. Total demand may be viewed by sectors (air, water and land transport) and through areas of demand as per the regions in which such transportation takes place. Land transport can be classified by the means of transport being used (road or rail transport) and it is defined by the route on which it takes place. Land transports can be domestic, on routes within a country or international, if it takes place between at least two countries.

Division of transport serves to provide transport users – passengers a quality service of access, use and choice for means of travelling. In order to take into account the demands of an individual group of rail transport users, we can categorise the trains in three transport categories [1]:

- (GPP) Inner city and suburban transport (ICST)
- (RP) Regional transport (RT)
- (DP) Long-distance transport (LDT)

Inner city – suburban transport, as mass transit, takes place in one gravitating region in daily migrations which is dependent on:

- Level of concentration of employment or education locations
- Level of concentration of places of residence
- Travel distance coefficient
- Coefficient for transferring from one means of transport to another
- Transport capacity utilization coefficient

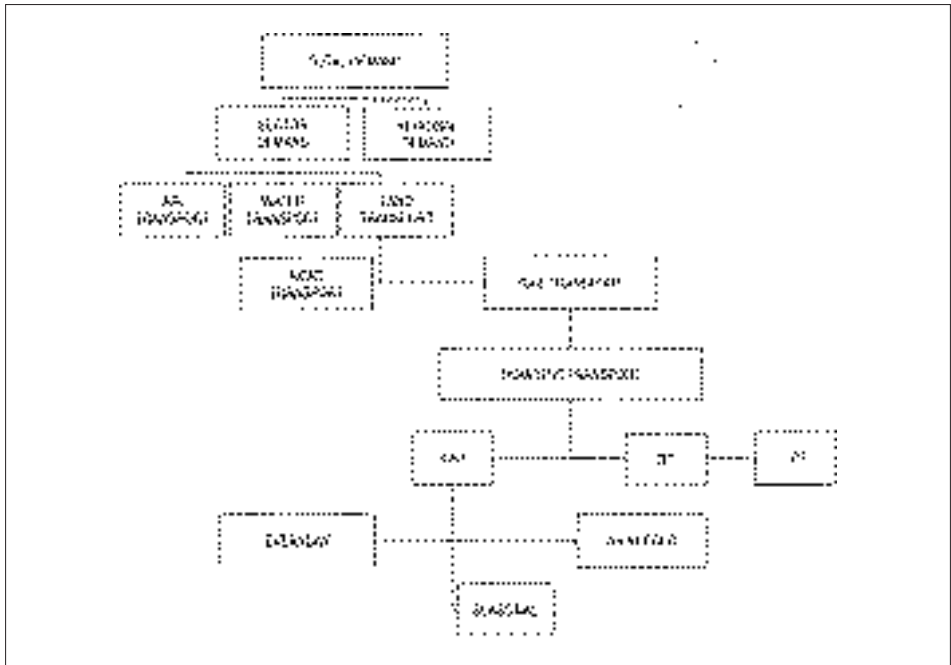


Figure 1 Concept demand model

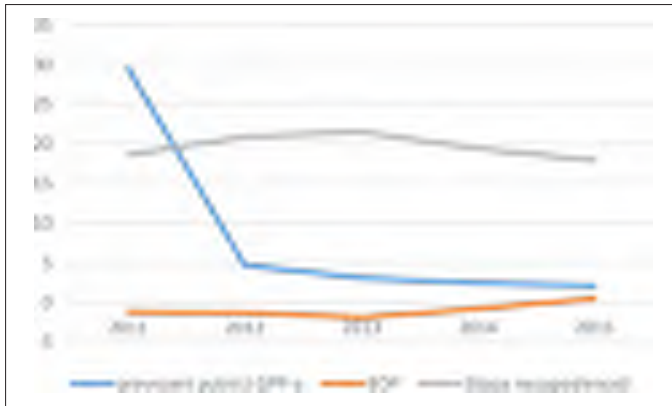
## 2 Structure of transported passengers in the Republic of Croatia in the transport subsystems

According to the data of the Croatian Bureau of Statistics in 2013 share of passengers transported by rail in the total number of transported passengers was 28.8% (Figure 2). When one passenger uses several modes of transport from specific transport branches, such passenger is counted as one passenger in each of them.



Figure 2 Structure of passenger transport according to transport types, January – June 2013. (Source: Croatian Bureau of Statistics)

In order to establish whether the percentage of increase or decrease of the gross domestic products has any influence on the travelling habits of the population, it was compared to the data of the HŽ putnički prijevoz on the number of transported passengers in the period from 2010 to 2015 [2]. For comparison, the data on the number of unemployed in the same time period was obtained from the Croatian Bureau of Statistics.



**Figure 3** Comparison of the GDP trend, number of transported passengers and unemployment rate trend (Source www.dzs.hr, HŽPP)

According to the data of the Croatian Bureau of Statistics [3] the value of the gross national product in the Republic of Croatia (Figure 4) viewed for the period 2010 – 2012 stagnated. In the period 2012 – 2013 the gross domestic product increased, and it slightly decreased in the period 2013 – 2015. A conclusion was made based on the comparison of the percentage of increase or decrease of the GDP, number of transported passengers and the unemployment rate (/prevezeni putnici GPP-a – transported passengers in the inner city-suburban transport area; BDP – GDP; stopa nezaposlenosti – unemployment rate/Figure 3), according to the data of the Croatian Bureau of Statistics and HŽ putnički prijevoz. Number of transported passengers i.e. number of sold tickets is not correlated to the GDP and the number of unemployed persons. Number of tickets sold suffered a steep drop in the period from 2010 to 2012 when there were no subsidized HŽ – ZET joint prepaid tickets.



**Figure 4** Gross National Product (Source www.dzs.hr)

### 3 Train capacity utilization

Analytical model for establishing the number of passengers travelling with HŽ putnički prijevoz, which is based on counting the number of passengers at the official locations when the passengers are boarding or leaving the train in a certain time period does not provide reliable information. Income generated through the sale of tickets does not follow the trend of the number of transported passengers (Figure 5).





**Figure 5** Chart of the number of transported passengers trend (Source: HŽPP)

Determining necessary capacities depends on the parameters which are dependent on the times of day, day in a week and a direction of travel. Therefore, in order to establish capacity the following parameters are needed:

- Number of trains during the peak load hours
- Number of trains during other times of day
- Train occupancy
- Route utilization
- Number of undefined passengers

Train occupancy coefficient varies with the time of the day. By dividing it into several time intervals we can calculate the average daily capacity of passenger train's occupancy. The calculation is based on each reference point on the route which we can define as an official location on the observed route with the regard to the passenger flows.

Considering the standing classification of trains in which they are not defined according to transport sector (inner city-suburban; regional transports), it is not possible to determine how many passengers from the inner city – suburban transport uses regional transport trains. Sesvete train station was set as an official calculation point, and six daily time periods and a total of 65 trains which perform actions at the train stations and stops so that the passenger can get on and off of trains (Table 1).

**Table 1** Daily intervals of the occupancy coefficient

	Occupancy coefficient (%)	Time period	Number of trains
K1	0,05	4:30 – 6:00	7
K2	0,8	6:00 – 8:30	13
K3	0,1	8:30 – 13:00	12
K4	0,6	13:00 – 16:30	13
K5	0,1	16:30 – 21:00	13
K6	0,05	21:00 – 0:05	7

*Source: chart 1a, timetable 2014/15, HŽI*

Based on the aforementioned time periods with different occupancy coefficients, and under the assumption that undefined passengers only appear in significant numbers during peak hours ( $K_{np2}=0,1\%$  and  $K_{np4}=0,05\%$ ), an average occupancy of the train at the daily level for one direction of travel can be calculated by using the following equation:

$$N_p = n_{kap} \cdot [n_{v1} \cdot K_1 + n_{v2} \cdot (K_2 + K_{np2}) + n_{v3} \cdot K_3 + n_{v4} \cdot (K_4 + K_{np4}) + n_{v5} \cdot K_5 + n_{v6} \cdot K_6]$$

[passengers/day]

Where:

- $n_{kap}$  – Capacity of the means of transport
- $n_{v1-6}$  – Number of trains in a certain time period
- $K_{1-6}$  – Train capacity occupancy coefficient
- $K_{np2 i 4}$  – Undefined passengers coefficient

Therefore:

$$N_p = 432 \cdot [7 \cdot 0,05 + 13 \cdot (0,8 + 0,1) + 12 \cdot 0,1 + 13 \cdot (0,6 + 0,05) + 13 \cdot 0,1 + 7 \cdot 0,05]$$

$$= 10.087,2 \text{ [passengers/day]}$$

In the year 2015, with 298 work days, at the subject location, according to average capacity usage, 3,005,958.6 passengers were transported in 18,775 trains with a maximum capacity of 8,110,368 passengers, which means that the average annual occupancy percentage on the work day was 37.07%. Taking into consideration that the sale of monthly tickets does not give any information on how many days the passengers use the tickets for riding the train and that these are high-school student/student and worker prepaid tickets, we made the following assumptions:

- Monthly high school student/student prepaid tickets used on the day from Mo – Fr.
- Monthly prepaid worker tickets are used on the day Mo – Sat.
- Return and RVC tickets are used on all days

According to these assumptions for the time period in which a reduced number of trains operates, for the remaining days the average daily occupancy coefficients reduces drastically and it is within 0.10 – 0.25 range. According to the data of the HŽ putnički prijevoz, out of 218,356 tickets sold at the official locations (Table 2) According to the data of the HŽ putnički prijevoz, out of 218,356 tickets sold at the official locations.

**Table 2** Number of dispatched passengers per official locations for the period 01.08. – 31.12.2015:

Official location	Number of tickets sold per travelling route						
	Dugo Selo	Sesvetski K.	Sesvete	Čulinec	Trnava	Maksimir	Zagreb GK
Dugo Selo		875	9.623	2.691	3.066	9.684	42.829
Sesvetski K.	441		687	109	194	569	5.931
Sesvete	7.021	830		109	1.199	3.201	39.121
Čulinec	1.273	195	491		6	351	7.939
Trnava	934	281	921	2		156	7.191
Maksimir	2.144	261	1.226	159	107		2.235
Zagreb GK	23.839	6.752	23.360	4.627	4.302	1.100	

Source: HŽPP

According to the above table, necessary capacities for the route sequence of official locations can be determined and according to this we are able to determine the relevant point for measuring the necessary capacities. Manner of tracking the passenger numbers by sold train tickets determines the route utilisation coefficient (Figure 6).

In the integrated passenger transport the aforementioned analysis can serve as the basis for optimisation of infrastructure capacities for receiving and dispatching passengers and capacities for other modes of transportation with which the passengers continue their travel, regardless whether this is personal transport or public city transport.

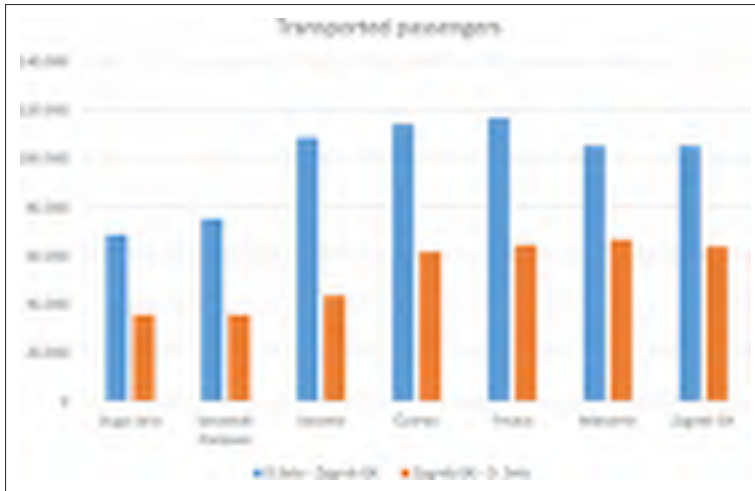


Figure 6 Necessary capacities through the route sequence of the official locations

#### 4 Spatial, temporal, quantity and structural optimization of transport capacities

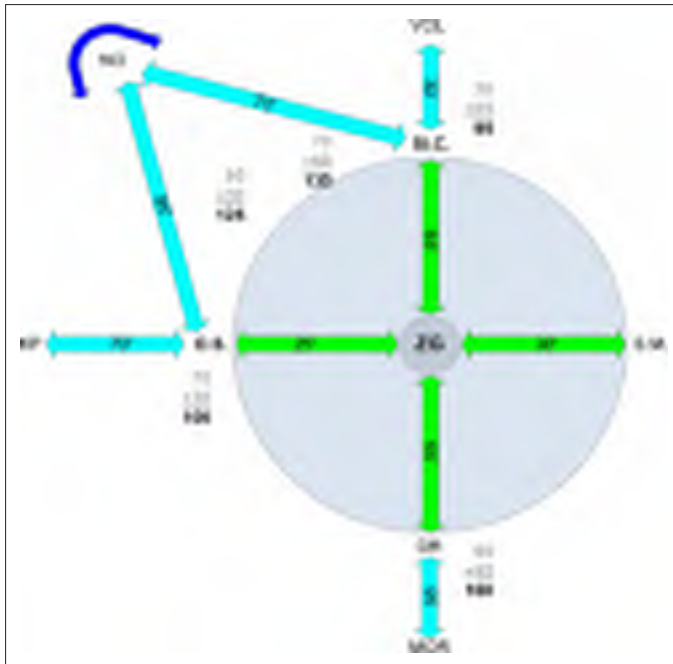
Optimization of transport capacities pertains to:

- Spatial optimization – separation of access infrastructure structures from other public areas by enclosing and grade separation.
- Temporal optimizations – introduction of regular interval timetable according to maximum throughput of a track section.
- Quantitative optimization – optimal number of powered trains for necessary demand capacities
- Structural optimization – defining the boundaries of transport regions by travel time distance.

Spatial optimization of capacities pertains to the physical means of separating platform areas from other public areas by barriers (fences, track grade separation and official locations – stops and elevated access ramps), dislocation of official locations – stops and elevated access ramps), dislocation of official locations – stops, building second track at single-track rails and determining the start-end train stations based on the travel time intervals (Figure 7). Physical separation of platform areas from public areas also allows for installation of passenger counting devices and the examples which can be followed for separation of the platforms from other public areas can be seen at the Čulinec and Maksimir stops where passenger access to the island platform is realised by underpasses so there is no crossing between the movement of pedestrians and trains.

Standardized platforms and hoods are placed at every renovation not only within the area of inner city – suburban transport, but in all official locations for receiving and dispatching of passengers. According to the existing accepted standards, minimal width of the island platforms without underpasses is 6000mm, whereas the width of the platforms with constructed underpasses/overpasses is 9500mm. [4].

Major overhaul of the Dugo Selo – Zagreb Borongaj track does not include the station areas of the Sesvete station and the access to platform areas and to the platforms themselves is arranged as maximum possible usable area between the tracks.



**Figure 7** Establishing transport boundaries based on the temporal component

Height of the arranged surfaces for entry and exit of passengers at the Sesvete and Dugo Selo stations are unacceptable due to them being unfit and impractical. The surfaces are located within the passenger safety zone and they are 1000 – 1200mm wide, and the height of the platform is 200 – 350mm. This was recognized as a problem as early as during the nineties of the last century [5].

By looking at the example of spatial placement of the Maksimir stop and Borongaj train terminals, we can see that there is a problem regarding passenger transfer from one mode of transport to another. In such cases, existing railway stops need to be moved to the immediate vicinity of other transport structures in order to facilitate access and transfer from one means of transport to another for passengers.

Temporal optimization of transport capacities denotes the temporal component by introducing regular interval timetable. By specifying the regular interval also determines the transport capacities during the day time intervals with regard to capacity requirements. In the Municipal Passenger Transport of the City of Zagreb a regular interval timetable of 10 minutes was proposed, which would enable maximum transport capacities in peak load hours (Figure 8).

Quantitative optimization means the renewal of transport capacities in quantities necessary for meeting the needs. Due the lack of funding, optimization had to be divided into stages. Desired final results of each of the specific stages determine how successful the realization was [6]. Structural optimization of transport capacities defines the division of passenger transport depending on the travel time distance and defines the boundaries of inner city-suburban transport, regional transport and long-distance transport. In the inner city-suburban transport areas, trains used inner city-suburban transport would have priority with regard to all other trains, and for passengers it would be made easier to get around and choose trains by certain visual identity of every train group.

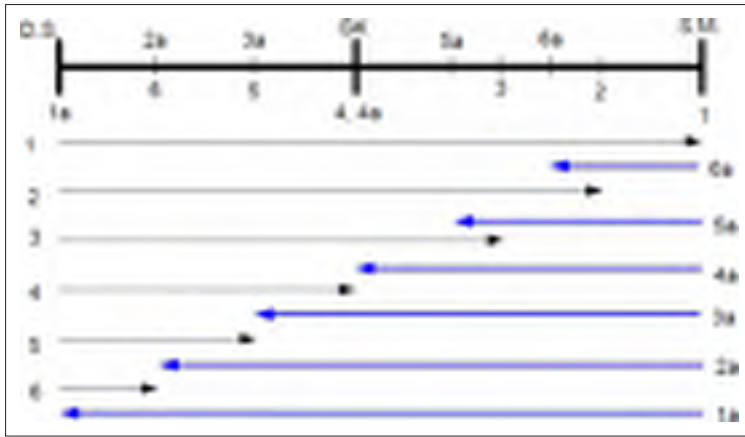


Figure 8 Position of each of the trains in the inner city – suburban transport in time  $t=55'$

## 5 Conclusion

In the passenger transport, the passenger participates in the process of service production i.e. the result and processes of production are indivisible. This means that each passenger carrier must ensure constancy of service, since every disturbance in the providing of such surface would have an effect on the passenger satisfaction. In order for the passenger carrier to, to meet passenger demands, the passenger carrier must constantly improve the quality of his service. The passenger is a transport object which has its own personality and certain requirements and the passengers demand safety, speed, comfort, tidiness and appropriate price for transport services. Therefore, the carrier must meet the high demands of the passengers and offer them appropriate level of service. Quality service increases passenger satisfaction and ensures passenger loyalty. For that purpose, the carrier must ensure availability of service and work on improving such service in order to remain competitive in the liberalized market. By tracking and analysing the everyday movements of passenger flows, and capacity utilization of an individual train the carrier is able to respond to passenger demands and improve the quality of provided services by changing the requirements in the amendments to the train timetable in effect which are done every two months. By drafting transport studies for urban environments, we seek an answer to the demand for public transportation in order to make a positive effect on the quality of life.

Area of the micro-location of the City of Zagreb in the inner city-suburban transport is the route of that type of transport under the greatest load, with largest number of passengers during the year. Considering the gravitation area, throughput of the track, constructed infrastructure, state of infrastructure subsystems, quality of traction and transport means and supply and demand of transport services, the study and obtained results are applicable to other parts of the network in which the inner city-suburban transport is organised. In order for the carrier to keep up with the passengers' demands, the work methodology needs to be adapted:

- by establishing zones of operation – taking into consideration time component of the distance and by setting the traffic rules and introducing a single transport identification, the quality of transport services is improved. Gains obtained by doing business in this way are an affordable ticket price, regularity and reliability
- by defining operating boundaries – by setting traffic rules and regulations, tariff harmonization and division of financial shares in the transport, it is possible to influence the amount of subsidies provided by the city, local communities or state in the inner city-suburban transport, which has an effect on the price of the transport card for end-user.

## References

- [1] Group of Authors: Studija razvoja i unapređenja kvalitete usluga gradsko-prigradskog željezničkog prijevoza putnika Grada Zagreba i okolnih županija, Zagreb: Fakultet prometnih znanosti, Sveučilište u Zagrebu, 2010.
- [2] "www.dzs.hr," [Mrežno]. [Pokušaj pristupa 20 01 2016.].
- [3] "Godišnje izvješće o stanju društva," HŽPP, Zagreb, 2016.
- [4] Stipetić, A.: Gornji ustroj željezničkih pruga, Zagreb: Fakultet prometnih znanosti, Sveučilište u Zagrebu, 2008.
- [5] Stipetić, A.: "Peroni u funkciji željezničkog prigradskog prometa," 1991.
- [6] Mlinarić, T.J., Schauperl, Z., Duvnjak, B., Pleša, T.: Studija opravdanosti investicije u nove prijevozne kapacitete – motorne vlakove, Zagreb: Fakultet prometnih znanosti, Sveučilište u Zagrebu, 2012.





## GREEN FUTURE FOR NARROW GAUGE RAILWAYS – VISION AND REALITY IN HUNGARY

Csaba Orosz<sup>1</sup>, Dóra Bachmann<sup>2</sup>

<sup>1</sup> *Budapest University of Technology and Economics, Department of Highway and Railway Engineering, Hungary*

<sup>2</sup> *Transinvest-Budapest Ltd., Hungary*

### Abstract

The history of narrow gauge railways starts at 1870 in Hungary. The first lines were constructed for industrial purposes: timber and stone delivery in forests, local logistic services in mines and in agriculture. Later narrow gauge railways began to have a role in regional and suburban transport too. Six thousand km long lines of such railways operated financially efficiently by 1914. Similar trends were Austria, Germany or Scotland. The nature of traffic began to change after 1920; public passenger transport gained more importance. After 1945 reconstruction supported the recovery of the agricultural sector. After 1968 many railway lines have been closed by political decision. For 2015 Hungary had 29 separate lines and companies with a total length of 503 km. (24 lines – 224 km are in operation.) The main present function of these “light railways” is green tourism. Only two forestry rail lines deal with freight transport. We have some 3800 passengers/day, 1,3 million passengers annually. [5000 to 380000 per company.] Currently operation is co-financed by “cross-financing subsidy” of the owner and/or the state. The Hungarian Co-ordination Centre for Transport [“KKK”] ordered a study concerning that topic in 2015. Our team has studied the present situation in the field of regulation, funding and investment. After consultations with local rail companies development proposals were collected. Finally we made some ranking concerning realistic proposals. The main considerations were: a) improvement of narrow gauge railways connected to tourism and to regional development objectives; b) green education for future generations. Introducing the Industrial Heritage to families, to “rail fanatic people”; c) promoting public service, enhancing competitiveness; d) better system performance facilitating “intermodal connections”.

*Keywords: narrow gauge railways, policy, tourism, infrastructure development*

### 1 History

The history of narrow gauge railways in Hungary starts in the 1870's. The first lines were constructed for industrial purposes: timber and stone delivery in forests, local logistic services in mines and in agriculture. 20 years later narrow gauge railways began to have a role in regional and suburban transport. By the beginning of World War I. 6000 km of narrow gauge rail tracks were in the country. (see Figure 1.) The nature of traffic began to change after 1920; public passenger transport gained more and more importance, long suburban vicinal lines were built. After World War II. the rapid reconstruction process and further improvement of the narrow gauge railways assisted to the recovery of the agricultural sector. The golden age ended in the late 60's, a significant proportion of railway lines have been discontinued by political decision. We have to admit, rail traffic could not compete with cars and busses, freight traffic was cheaper and more competitive on roads.



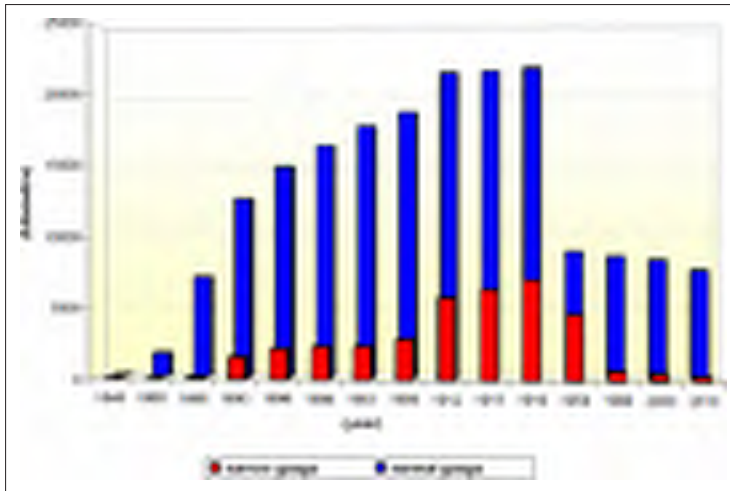


Figure 1 Length of normal and narrow gauge railway network in Hungary 1846-2010 [1]

## 2 Narrow gauge railways in Hungary in 2015

For 2015 Hungary had 29 separate lines and companies with a total length of 503 km (224 km was in operation.) – see Figure 2. Nowadays the main function of these “light railways” is green tourism. Only two forestry railways are dealing with freight transport and one destination is involved in regional public transport. Table 1 shows the main characteristics of Hungarian narrow gauge railways: location [b], function [d], and technical features [e-f-g-h-i]. We can make the following general observations:

- The most common narrow track gauge is 760 mm in Hungary,
- The vast majority of locomotives are with diesel engine, but there is a strong aspiration is to replace the fleet with green vehicles (hybrid or solar propulsion),
- About ownership we can say that:
  - 188 km (37%) are owned by Hungarian State Railways, but only 12 km is in operation,
  - 223 km (46%) are owned by state forestry,
  - 6 lines (50 km, 10%) are owned by municipalities,
  - other 8 lines (50 km) are owned by other companies (eg. national park, museum).

The annual number of passengers carried is around 1.3 million: varies between 5,000 and 380,000 per company – see Figure 3. According to the annual performance we can divide the individual lines to small- or large-profile railway group (Table 1, column [j]). Railways under 30,000 passenger/year can be considered small-profile railway. They differ in terms of

- rail system (rail profile 9-23,6 / 23,6-48 kg per meter),
- vehicles (engine power output),
- braking mode (hand brake / air brake),
- travel speed (15 / 20-40 km/h),
- schedule (timetable throughout the year or seasonal).

The most visited site is the Children’s Railway with 380,000 passengers per year. Except the train driver, and one adult per station all of the posts are operated by children aged 10–14. The railway is financially strongly supported by Hungarian State Railways, and plays an educational role as well. The financially most efficient light railway is “Szilvásvárad State Forest Railway”. The line is relatively short (3.6 km), and the site attracts many visitors.



Figure 2 Narrow gauge railways in operation in Hungary in 2015 © Jakóts Ádám

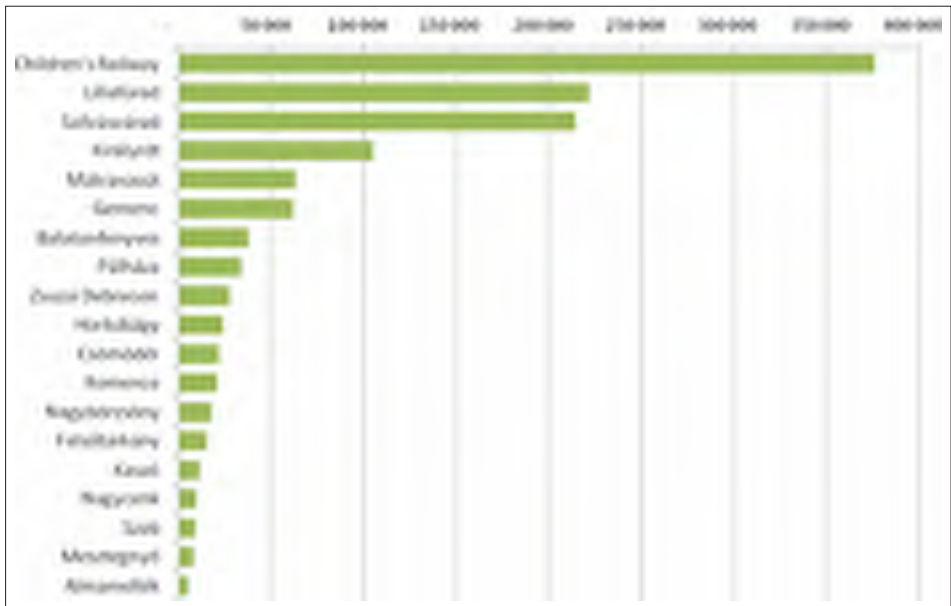


Figure 3 Annual Passenger Traffic of Narrow Gauge Railways in 2014 [3]

Currently operation is co-financed by “cross-financing subsidy” of the owner and/or the state. Only a few large-profile railways can cover 60-100% of the cost of operation by ticket revenues, small-profile railway are able to finance only 10-40% of costs. Operation subsidies and development funds are not equally available to all participants. Standards created for international railway network and applied for narrow gauge railway imposes disproportionate burdens both in technical and in financial sense.

**Table 1** Narrow gauge railway lines with important data in Hungary, 2015. [3]

Name	Location	Owner
[a]	[b]	[c]
1 Almamelléki State Forest Railway	Baranya County	Mecsek Forestry Ltd.
2 Balatonfenyvesi Field Railway	Somogy County	Hungarian State Railways Ltd.
3 Csömödéri State Forest Railway	Zala County	Zala Forestry Ltd.
4 Debreceni Amusement Park Railway	Hajdú-Bihar County	Debrecen Municipality
5 Fehér-tavi Fish Farm Railway	Csongrád County	Szegedfish Ltd.
6 Felcsút, Vál-Valley Light Railway	Komárom-Esztergom County	Foundation for Youth Football Development
7 Felsőpetényi Mine Railway	Nógrád County	Clay Mineral Ltd.
8 Felsőtárkányi State Forest Railway	Heves County	Eger Forestry Ltd.
9 Gemenci State Forest Railway	Budapest	Gemenc Ltd.
10 Children's Railway, Budapest	Tolna County	Hungarian State Railways Ltd.
11 Hortobágy, Öreg-tó Railway	Hajdú-Bihar County	Hortobágy National Park
12 Kaszói State Forest Railway	Somogy County	Kaszó Forestry Ltd.
13 Kecskeméti Railway	Bács-Kiskun County	Hungarian State Railways Ltd.
14 Kemencei Forest Museum Railway	Pest County	Ipoly Forestry Ltd.
15 Királyréti Forest Railway	Pest County	Ipoly Forestry Ltd.
16 Lillafüredi State Forest Railway	Borsod-Abaúj-Zemplén C.	Northern Forestry Ltd.
17 Mátravasút, Gyöngyösi State Forest Railway	Heves County	Eger Forestry Ltd.
18 Mecseki Amusement Park Railway	Baranya County	Pécs Municipality
19 Mesztegnyői State Forest Railway	Somogy County	SEFAG Ltd.
20 Nagybörzsönyi Forest Railway	Pest County	Nagybörzsöny Municipality
21 Nagycenki Széchenyi Museum Railway	Győr-Moson-Sopron C.	Hungarian Museum of Science, Technology and Transport
22 Nyírvidéki Railway	Szabolcs-Szatmár-Bereg C.	Hungarian State Railways Ltd.
23 Pálházi State Forest Railway	Borsod-Abaúj-Zemplén C.	Hungarian Open Air Museum
24 Szentendrei Museum Railway	Pest County	Észak Forestry Ltd.
25 Szilvásváradi State Forest Railway	Heves County	Eger Forestry Ltd.
26 Szob-Nagybörzsöny Forest Railway	Pest County	Szob and Márianosztra Municipality
27 Tiszakécskei Railway	Bács-Kiskun County	Tiszakécske Municipality
28 Tömörkényi Fish Farm railway	Csongrád County	Tömörkény Agricultural Ltd.
29 Zsuzsi Forest Railway, Debrecen	Hajdú-Bihar County	Zsuzsi Forest Railway Nonprofit Ltd.

**Table 1** Narrow gauge railway lines with important data in Hungary, 2015. [3] (continued)

Function	Traction	Gauge	Length	No. of locomotives	No. of rail wagons	Profile
[d]	[e]	[f]	[g]	[h]	[i]	[j]
Tourism	diesel	600 mm	8 km	2	4	small
Commuter traffic, Tourism	diesel	760 mm	12 km	6	26	large
Freight, Tourism	diesel/steam-engine	760 mm	90 km	15	59	large
Tourism	diesel	760 mm	1,1 km	1	4	small
Freight	diesel	600 mm	7,5 km	9	69	small
yet not in service (Tourism)	diesel	760 mm	5,7 km	2		large
out of service (Tourism)	diesel/electric	600 mm	5 km	4		small
Tourism	diesel	760 mm	5 km	2	9	small
Freight, Tourism	diesel/steam-engine	760 mm	30 km	5	78	large
Tourism	diesel/steam-engine	760 mm	11 km	7	30	large
Tourism	diesel	760 mm	5 km	1	8	small
Tourism	diesel/steam-engine	760 mm	8 km	2	5	small
out of service (Commuter, Tourism)	diesel/steam-engine	760 mm	98 km	4	41	large
Tourism	diesel/electric	600 mm	5 km	20	46	small
Tourism	diesel/steam-engine	760 mm	10 km	6	29	large
Tourism	diesel/steam-engine	760 mm	27 km	7	49	large
Tourism	diesel/steam-engine	760 mm	20 km	10	20	large
Tourism	diesel	760 mm	0,6 km	1	3	small
Freight, Tourism	diesel/steam-engine	760 mm	9 km	3	38	small
Tourism	diesel	760 mm	8 km			
Tourism	diesel/steam-engine	760 mm	5 km	2	12	small
out of service (Commuter, Tourism)	diesel	760 mm	67 km	7	35	large
Tourism	diesel	760 mm	8 km	2	11	small
Tourism	diesel	1435 mm	2,2 km	1	2	
Tourism	diesel/steam-engine	760 mm	5 km	6	21	large
Tourism	diesel	760 mm	22 km	8	12	large
out of service (Tourism)	diesel	760 mm	1,2 km	1	2	small
Freight, Tourism	diesel	760 mm	15 km			
Tourism	diesel/steam-engine	760 mm	17 km	4	26	large

### 3 Strategy for the future

The Hungarian Co-ordination Centre for Transport (Hungarian Transport Administration, “KKK”) ordered a study concerning that topic in 2015. The aim of the Narrow Gauge Railway development Concept was to give a comprehensive “state of the art” report on a less preferred area in the railway sector, and to prepare the 2014-2020 EU planning period complying a list of feasible and green development projects.

The scope of the railways to be examined comprised narrow gauge railways dealing with passenger transport (existing or under implementation) and planned developments identified in the National Regional Development Concept and in County Development Plans. Our team has studied the present situation in the field of regulation, funding and investment. As the different narrow gauge railway lines are supervised by different ministries it was a considerable challenge to harmonize a common and valid database.

- Problems, development solutions, safety issues and requirements usually occur at the National Transport Authority;
- Public transport, public funding and transport development belongs to the Ministry of National Development;
- Ministry of National Economy is responsible for tourism, nature tourism and tourism development funds.

Our proposals to rationalize the legal-regulatory area that the rules and standards should reflect on railways safety risks. This may result that some areas – compared to the national networks – will be under-regulated, while others get more attention. The conditions should be determined according to risk, leaving out certain elements of the licensing process or different (lower) requirement should be set.

After consultations with local rail companies development proposals were collected. Finally we made some ranking concerning realistic proposals. As “light railways” cannot cover even their running costs, investments can be hardly recoverable. Scarce resources should be devoted to the busiest lines, long and unused extensions should be avoided. The main considerations of the study were:

- Improvement of narrow gauge railways connected to tourism and to regional development objectives.
- Green education for future generations. Introducing the Industrial Heritage to families, to “rail fanatic people”.
- Promoting public service, enhancing competitiveness.
- Better system performance facilitating “intermodal connections”.

This is a brief summary of a long study of 170 pages and Annexes. Furthermore we prepared 5 pre-feasibility studies of 5 narrow gauge railway networks selected by the principal. We have analyzed several development options, and estimated costs, benefits and potential traffic.

## References

- [1] Jéger, G.: Keskeny nyomközű vasutak földrajzi jelentősége Magyarországon. Doktori (PhD) értekezés tézisei (Importance of Narrow Gauge Railways in Hungary – PhD thesis) pp. 185. Miskolc, 2010.
- [2] F&B Consulting Kft – Xellum Kft.: Magyarországon működő kisvasutak helyzetének elemzése, fejlesztésük lehetőségei, fenntartható működésük. (Narrow Gauge Railways in Hungary – situation, possibilities for development, sustainable operation) Prepared on behalf of Ministry of Local Government and Regional Development, pp. 176, Budapest, 2008.
- [3] Transinvest-Budapest Kft.: Országos Kisvasúti Konceptió (National Development Plan for Narrow Gauge Railways) Prepared on behalf of Hungarian Transport Administration, pp. 238, Budapest, November, 2015.
- [4] Stratégia konzorcium: Nemzeti Közlekedési Stratégia – Országos Vasútfejlesztési Konceptió (National Transport Infrastructure Development Strategy – National Railway Development Plan) Prepared on behalf of Hungarian Transport Administration, pp. 173+annexes, Budapest, October, 2013.
- [5] Horváth, S.M.: Magyarországi kisvasutak fejlesztésének néhány kérdése. Tudományos diákköri konferencia dolgozat (Some Development Elements of Narrow – Gauge Railways in Hungary – Paper for Scientific Student Conference at Budapest University of Technology and Economics), Budapest, 2015.



## EXAMPLES OF FLEXIBLE FOUNDATIONS OF SOIL-STEEL STRUCTURES MADE OF CORRUGATED SHEETS

Czesław Machelski<sup>1</sup>, Adam Czerepak<sup>2</sup>, Mario Bogdan<sup>3</sup>

<sup>1</sup> *University of Technology Wrocław, Poland*

<sup>2</sup> *ViaCon Sp. z o.o., Poland*

<sup>3</sup> *Protekta. d.o.o., Zagreb, Croatia*

### Abstract

Soil-steel structures are the engineering structures that also fulfil the functions of bridges, flyovers, pedestrian bridges, culverts, tunnels, subways, farm accommodation bridges or wildlife crossings. A large group of these structures serves as municipal facilities, normally shaped as closed pipes or intended for transport purposes, e.g. for the housing of the conveyor belts. They are constructed in the form of a corrugated steel structures (steel shell) and the surrounding, specially concentrated soil. They are designed in a manner ensuring a long-lasting, beneficial interaction between essential elements of the bearing system in a classic design, that is, the shell, founded on the foundation, and the soil backfill.

*Keywords: soil-steel structures, corrugated sheets, tunnels, culverts*

### 1 Introduction

The effect of interaction of the shell with the soil is observed as an apparent relief of a vulnerable shell (called bridging in reference [1]). The intensity of impact exerted by the soil on the bearing structure depends on the stiffness of the shell in relation to the backfill that surrounds it. For this reason, the soil-steel structures are divided into two principal groups: stiff and vulnerable. When designing vulnerable soil-steel structures the backfill and the surface of the road are treated as essential elements of the bearing structure [1]. In a stiff structure, they perform very different roles [1]. The steel shell in the soil-steel structure fulfils two different technical functions. During backfill laying, the shell acts as a formwork that secures the space under the structure, and during the use of the finished structure, it interacts with the soil and the surface in the transfer of constant and variable loads. The construction phase is important for the safety of the steel shell, which is exposed to the greatest displacements and internal forces. Hence, this situation is considered mainly when selecting the geometric parameters of a sheet.

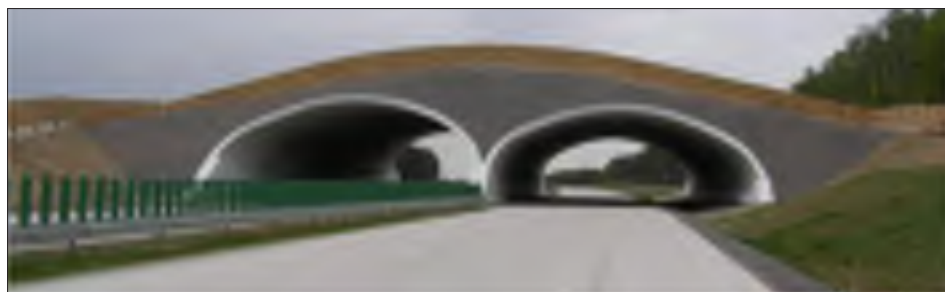


Figure 1 Central support of a twin soil-steel structure

## 2 Classification of soil-steel structures foundations

Monographs [1, 2] present typical (currently produced) corrugated steel structures cross-section profiles. According to the foundation, shapes of steel shell cross-section profiles are divided into two groups: closed-bottom shapes (founded on a soil sub-base) and open-bottom shapes (mounted on the foundation). Shells with a closed-bottom circular shape form circular, elliptical, vertical and horizontal, as well as drop-shaped and pear-shaped cross-sections. Shells with an open-bottom shape constitute a group of arch-shaped, low-profile and high-profile cross-sections, and box-shaped cross-sections [1, 2]. According to the shape of the steel shell in a soil-steel structure, the steel shell supports, listed in Table 1, are constructed.

Table 1 Measuring results

No.	Shape of the corrugated steel structures	Type of corrugated soil-steel structure foundation
1	closed-bottom	on a soil sub-base
2		in a watercourse
3		horizontal
4		vertical
5		non-piled
6	open-bottom	on piles
7		with a retaining wall
8		topped with a strip footing
9		on a precast foundation
10		on a concrete foundation
		in the form of a beam grid
		in the form of a solid footing

## 3 Closed-bottom foundations of soil-steel structures

### 3.1 Placement of soil bedding sub-base for the corrugated steel structures

Sand bedding is used for the construction of foundations for closed-bottom shells made from corrugated steel sheets. For structures with greater spans, an aggregate sub-base is used, on which an appropriate backfill and shell contact layer is placed. Fig. 2 shows the initial phases of the construction of the structure. The contact layer is profiled with the use of a template shaped to conform with the curvature of the shell. On such a sub-base, the lower bowl of the shell is mounted, and then the side walls are constructed from corrugated sheets. Methods of corrugated steel structures erection, sheet manufacturing technology and selection of materials are discussed in [2]. This type of foundation is used as a standard solution for closed-bottom steel shells. It cannot be used in the case of active watercourses.





**Figure 2** Classic closed-bottom foundation of soil-steel structures

### 3.2 Soil-steel structures placed in a watercourse

Cases when a pipe-shaped corrugated steel structure is being placed in a watercourse, without connection with the construction period, constitute a difficult task for the engineers. In such a specific situation, an inadequate shaping of a sub-base from waterlogged native soil occurs. Thus, it is important to place the soil backfill layer under the shell while maintaining the design geometry of the shell, both in cross-sections and in the axis of the tube. In [2], a description of the construction process and results of tests on the culvert was provided, as in Fig. 3.

The structure that is discussed here was built along the road from Niemodlin to Lewin Brzeski. An obstacle was a channel characterised by a constant, high water level (of 1 m), with a width of 3 m and a very low hydraulic gradient of 0.4%. The culvert was made from MP 150-50-5 corrugated steel sheet, and in its construction, 150 GL-6-type shell geometry was applied. The tube was formed from corrugated sheets in the vicinity of the point where it was placed, on a shelf with a width of 5 m, formed above the water level (approximately 15 cm).



**Figure 3** Initial phases of the construction of the structure in a watercourse

Sheets were folded according to a sequential method; that is, one coat after another. After the entire steel structure was erected (the example of erection with full prefabrication), it was inserted into the channel with an excavator, which fulfilled the function of a crane. A total reconstruction period (dismantling the former structure and construction involving the placement of the asphalt surface) of the culvert was two weeks, including all downtime. The bottom of the watercourse under the shell was protected with the backfill through an appropriate process of compaction and loading process of the soil placed on both sides of the corrugated steel structure. As a result of the compaction of the soil backfill around the steel culvert, the raising of the shell occurred. In the crown of the structure, the ordinates from the inside and on the outside of the shell, as well as the height of the vertical clearance of the culvert were measured. In this way, changes in the corrugated-steel structure cross-section deformation



were controlled. After obtaining an appropriate longitudinal gradient and a sufficient level of backfill above the watercourse, the road embankment could be formed in accordance with a classic formation method. The subsequent layers of backfill were compacted by repeated passing of a loader with a weight of 24 tons (roller compacting), with a simultaneous compactive effort applied by a vibratory plate attached to the compactor. Thanks to a simultaneous use of the three methods that were applied in the construction of these structures, it was possible to increase thickness of the layers that were being formed.

## 4 Founding the soil-steel structures on a corrugated sheet

Thanks to the soil whose compaction constantly increases, vulnerable soil-steel structures increase their stiffness [3, 4, 5], which has an impact on an increase in the ability to carry greater and greater useful loads while using such structures. This is a feature, different than in the classic bridges, characteristic of those structures in which the load-carrying capacity reduces in the course of structure deterioration process. Results of tests and numerical analyses of the constructed structures suggest that the reduction in stiffness of the shell causes the reduction in the internal forces in the shell. This means that the moving loads that are exerted on the road of the bridge are to a lesser extent transferred on a delicate shell, while there is an increase in the strain in the internal vault, formed in the soil backfill. The above conclusion suggests that one should tend to design shells with lesser sheet thickness and lower wave heights (and to resign from overlays). In an extreme case, experiments also indicate the possibility of using a flat sheet [4].

A comparison of the flow of forces in the classic arched bridge and the structure formed from a vulnerable shell immersed in the soil shows that there is a significant, visible difference in their trend [4]. In the soil-steel structure, an internal vault is formed in the backfill, which carries the loads of the soil surcharge, formed above the shell up to the native soil layers. In the literature, this phenomenon is called bridging [1, 2]. Therefore, in the soil-steel structure, the construction of a stiff foundation is not necessary, as the solid foundations restrict the flow of forces in the backfill. Thus, it can be concluded that a vulnerable support is also adapted to a vulnerable steel sheet, as shown in the examples of structures discussed below. A vulnerable support of a steel shell facilitates the formation of a natural vault in the soil backfill and in the native soil base [4]. In this case, it is important to design the shape of the shell similar to the parabolic arch shape. Another issue that comes to mind in connection with the above specific features of the bridges discussed here, is the idea of searching for benefits that result also from the manner of the foundation of such bridges. Selected examples of structures constructed with the use of vulnerable supports for the open-bottom shells are provided below.

### 4.1 Supporting the soil-steel structures on a horizontal corrugated sheet Support on a wall made from corrugated sheet

Open-bottom corrugated steel structure (Fig. 4) together with a component of the foundation made from corrugated sheet during the process of erection on the previously prepared sub-base. The whole steel structure of this built feature is being placed on gravel bedding with the use of a crane. This type of foundation is often used in the engineering structures when time is of the essence. In this case, there is full prefabrication of the corrugated steel structures, including the support. The effectiveness of this method is confirmed by experiments performed as part of numerous tests on the structures constructed in this manner.



Figure 4 Erection of the corrugated steel structure with an attached support in the form of a flat sheet

#### 4.2 Supporting the soil-steel structures on a horizontal corrugated sheet Support on a wall made from corrugated sheet

The example of a prototype support of a corrugated steel structure on a delicate wall (vertical corrugated sheet) was designed on the structure located along a local road with little traffic, but intended for heavy weight vehicles. In fact, the main load exerted on this structure is the lorries transporting spoils excavated material from quarries to the Bartnica train station near Nowa Ruda [2]. The corrugated steel structure has been designed from low-profile MP 150-50-5 sheet with a half-circular shape and a span of  $L = 5.00$  m. The width of the structure was  $B = 15.0$  m. The wall is immersed in the native soil down to the depth of approx. 1.00 m. In this case, the essential element of the support structure is a groin made from a circular corrugated sheet sector that was used to construct the wall and the shell. The soil backfill laid behind the corrugated steel structure is protected from the watercourse side with a corrugated sheet wall, as in Fig. 5. The first built-in component of the support is a corrugated sheet, placed vertically in a watercourse, as in Fig. 3. Its stabilisation in the support line is achieved with the use of the soil material obtained from the place of construction. This wall is used for fixing the groin, as in Fig. 5. The groin, made from circular-sector-shaped sheets, is attached to vertical sheets with the use of screws. The groin rests on low-strength concrete bedding. In the use phase, it is supposed to protect the structure of the shell against settlement. Corrugated sheets of the shell with the supporting part are joined in a classic (for these shells) overlap fashion.



Figure 5 Corrugated sheet wall with a groin supported on the native soil

## 5 Supports on piles

Fig. 4 presents the examples of prototype soil-steel structures constructed using the support on piles, which were arranged along a single line. This case is completely different from the spatial arrangement of piles topped with a cap beam, used for classical foundations. The greatest success was the foundation of the shell made of flat sheet on piles made of steel sections. It was constructed in the ring road region of Niemcza with the use of a specific foundation for a soil-steel structure, as shown in Fig. 6 and discussed in paper [3].

### 5.1 Supporting the corrugated soil-steel structures directly on piles

A pile support made of steel pipes and used for the structure made of corrugated sheets with an MP 200-55-7 profile was designed and constructed in Świdnica [3]. The structure was created in the location of a formerly used flyover with a steel structure. The inlet and the outlet were finished with reinforced concrete portals with wings situated parallel to the axis of the track. The span of the shell in the support line is  $L_0 = 9.49$  m, and its maximum horizontal clearance is  $L = 10.31$  m. The height of the shell measured from the support level up to the crown is  $h = 5.50$  m. The shell was mounted from the sheets attached to corrugated sheet of the shell from the obstacle side. The space between the supporting sheets, as in Fig. 6, was filled with concrete.



Figure 6 Supporting the soil-steel structures on piles

### 5.2 Retaining wall founded on reinforced concrete piles

The support on reinforced concrete piles was designed in a tunnel with a length of 67.30 m in Biernacie. The span of the steel shell in the support line is  $L_0 = 9.50$  m, and its maximum horizontal clearance is  $L = 10.36$  m. The height of the shell measured from the support level up to the crown is  $h = 5.90$  m. The shell was made from a corrugated sheet with a low MP 150-50-7 profile. The sheet of the shell was directly supported by a reinforced concrete wall with a height of 1.40 m and a thickness of 0.3 m. The structure of the retaining wall was founded on reinforced concrete piles with a diameter of 60 cm and pile spacing of 3 m, drilled in the soil down to a depth of 6 m, as in Fig. 7. Thus, the thickness of the wall was half the diameter of the pile, which allowed for extending the half of the pile longitudinal reinforcement from the pile. The inlet and the outlet of the tunnel were finished with reinforced concrete portals with wings situated parallel to the axis of the track, with a length of 10 m each.



Figure 7 Supporting the soil-steel structure on a wall topping the piles

## 6 Concrete foundations

### 6.1 Precast concrete footings

The construction of concrete strip footings can also be accomplished with the use of prefabrication. In the example shown in Fig. 8, the used foundation was a shallow foundation on the level of the soil, though with the anchoring of precast components, with piles made in the monolithic technology. The reinforcement made of these two components was joined in the crowns drawing the precast components in the strip footing. The method of the erection of the foundation and the shell is presented in Fig. 8.



Figure 8 Supporting the soil-steel structures on piles

### 6.2 Supporting the soil-steel structures on a beam grid

The method of support that is analysed here was designed in a soil-steel structure constructed as a road tunnel under a ski trail in Karpacz, Lower Silesia Province [13]. It was made in an open-cut excavation, with walls protected with the use of prestressed soil anchors. A steel shell made of corrugated sheet type MP 200-55-7, with a typical VBH19 shape, was used for tunnel lining. Essential catalogue dimensions of the cross-section of the tunnel are as follows: a span of  $L = 11.15$  m, a height of  $h = 6.48$  m, and an upper radius of  $R = 7.07$  m. The steel shell is founded on a concrete foundation, and the distance between the shell support points is  $L_0 = 10.23$  m. In a top view, the axis of the tunnel is geometrically complex, resembling the C letter, and the road gradeline slope is variable. The length of the tunnel is approx. 100 m. A specific method consisting in supporting the shell on a beam grid was applied for the structure. Classically constructed concrete footings were joined with transverse, reinforced concrete components.

### 6.3 Solid foundations

The foundation applied for the open-bottom, arched-shaped steel shells is most frequently (as a general rule) the reinforced concrete foundation, as in Fig. 9. This applies to both concrete layers and the ones made of corrugated sheets. The concrete foundation of the largest dimensions was designed and constructed in a structure to be used under the shell made of corrugated sheets, with a base width of 4.0 m and a height of 3.1 m; and a length of the structure was nearly 60 m. On such a foundation, it is possible to successfully construct even a classic concrete bridge.



Figure 9 Soil-steel tunnel foundation on a beam grid / Solid foundation of a soil-steel structure

## 7 Conclusions

Observably, in vulnerable soil-steel structures, the impact exerted by the backfill on the steel shell immersed in the soil is lower than in the case of stiff structures. This is due to the fact that, in these structures, a natural vault is formed in the soil backfill. Such a vault is limited from the top by the road surface, and from the bottom by the curve of the steel shell. In the literature, this phenomenon is called bridging [2], although in a natural situation, it occurs as a result of the formation of an opening inside stable rock mass, and not in an embankment of the constructed soil-steel structure. In such a situation, a constant weight of the soil surcharge (the soil backfill and the road base) and the moving loads cause much smaller reactions of the shell towards the foundation than in the case of a stiff (classic) arched structure. The conclusion of this discussion is that vulnerable shells should be constructed on vulnerable supports, rather than solid foundations. Thus, the examples of vulnerable foundations of the soil-steel structures presented in the paper are also adapted to lightweight structures of shells made of corrugated sheets. Another relevant feature of the supports presented here lies in the technological qualities of their construction in difficult terrain conditions. The results of the studies conducted so far suggest that a support has a significant impact on the internal forces and deformation of soil-steel structures.

## References

- [1] Machelski, C.: Budowa konstrukcji gruntowo-powłokowych. Dolnośląskie Wydawnictwo Edukacyjne, Wrocław 2013.
- [2] Machelski, C., Antoniszyn, G., Michalski, B.: Influence of Live load on the Soil-steel shell Bridge Founded on Elastic Supports. *Studia Geotechnica et Mechanica*. 2-4/2006, pp. 65-82
- [3] Machelski, C., Michalski, J.B., Michalski, B.: Case study of steel shell structure supported on piles. *Archives of Institute of Civil Engineering*. I European Symp. Rydzyna 23-24 April 2007.
- [4] Machelski, C., Michalski, J.B., Janusz, L.: Application of Flexible Foundations under Soil-steel Bridges. 89th Annual Meeting Transportation Research Board, Washington, January 11-15, 2010, pp. 10-0950 (CD).
- [5] Machelski, C., Mońka, M.: Prognosis of deformation of a soil-steel structure on steel, corrugated, flexible supports. *Archives of Institute of Civil Engineering* No. 12/2012, pp. 147-156.

## 9 INFRASTRUCTURE MANAGEMENT





## ENHANCING RAILWAY INFRASTRUCTURE ASSETS AGAINST NATURAL HAZARDS

Jelena Aksentijevic<sup>1</sup>, Andreas Schöbel<sup>1</sup>, Christine Schönberger<sup>2</sup>

<sup>1</sup> *OpenTrack Railway Technology Ltd., Austria*

<sup>2</sup> *ÖBB-Infrastruktur AG, Austria*

### Abstract

The transportation system in Alpine countries plays a vital role in the European transit of passengers and freights from north to south and east to west. In addition, transportation lines are essential for the accessibility of lateral valleys and their economic welfare. In mountain areas, extreme weather events regularly trigger hazardous and torrential processes like different kinds of flooding, landslides or avalanches and their intermixtures. Their intensity will increase in the next years due to climate change. As railway infrastructure has a bottleneck function in the Alps, this case study will focus on enhancing resilience of a transportation network in a multi-hazard context and on reducing adverse effects of natural hazards in the transportation infrastructure in Austria.

*Keywords: natural hazards, resilient railway infrastructure, flood damage railway model*

### 1 Introduction

Over the years, given their central position in Europe, Alpine railways became key for freight transport and travellers with growing economic perspectives. Moreover, the Austrian railway network is also essential for the accessibility of lateral alpine valleys and is thus of crucial importance for their economic and societal welfare. If traffic networks are (temporarily) disrupted, alternative options for transportation are rarely available.

The harsh mountainous nature of the Eastern Alps, within which 65% of the national territory of Austria is situated (Permanent Secretariat of the Alpine Convention, 2010), poses a particular challenge to railway transport planning and management issues. Due to limited usable space or for reasons of economic or technical feasibility, railway lines often follow rivers in valley plains and along steep unsteady slopes, which considerably exposes them to flooding and, in particular, to alpine hazards such as debris flows, rock falls, avalanches or landslides. These can lead to disruption of railway tracks, causing large economic damages and temporary closures of line sections; since railway tracks and bridges can be washed away or can be severely damaged. Such events can cause substantial damage to railway infrastructure and pose a risk to the safety of passengers, wherefore they are a great issue of concern for the Austrian Federal Railways (ÖBB).

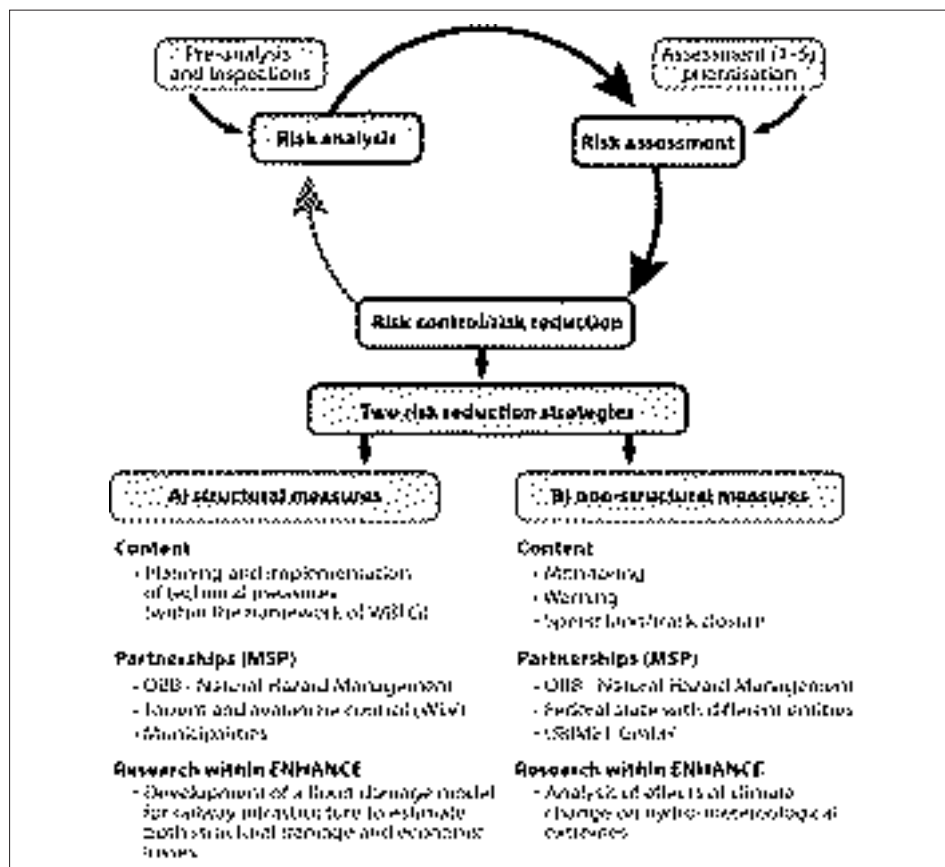
The Austrian Railway Infrastructure AG (ÖBB Infra), along with the civil and governmental partners are left with the difficult and costly mandate to assess risks, take preventive measures, and ensure the continuous operation of the network. Although done with dedication, the risk partnership suffers from mixed information exchange and cost-sharing divergence. Hence, risk analysis and management are important issues of railway operation in Austria, which is indicated by the fact that the ÖBB maintains an own department for natural hazard management and partnerships with various stakeholders at different administrative levels.



In this context, the ÖBB follows two main risk management strategies, namely:

- The prevention of Alpine hazards through the implementation of structural protection measures.
- The use of non-structural/organization risk reduction strategies such as a weather monitoring and warning system.

Both strategies, the MSPs collaborating in the respective risk reduction strategy and the research conducted within the ENHANCE project are depicted in Figure 1.



**Figure 1** Two main strategies of risk reduction in railway transport and according work strands in ENHANCE. Source: own illustration. Information derived from interview/consultation 12. [WBFG = Hydraulic Engineering Assistance Act; MSP = Multi-stakeholder partnerships; ÖBB = Austrian Railway Infrastructure].

To protect their railway infrastructure from Alpine hazards, the ÖBB plans and implements structural (protection) measures on its own. If other stakeholders are affected by these protection measures, the ÖBB engages in partnerships to jointly plan and implement them. The core of these partnerships on structural measures lies in cost sharing and, in preparation for it, also in information exchange. It includes both formal, standardized processes fixed in regulations, as well as informal elements and ad-hoc negotiations. Further details on the strategies and specifications of the multi-sectoral-partnerships (MSPs) identified in this case study can be found in [7].

Since the possibility to address the risks from natural hazards in the Alpine topography by means of technical protection measures such as dikes or avalanche protection is limited, due to the sheer number of torrents and avalanche paths, the ÖBB additionally engages in non-structural/organizational risk reduction measures. This strategy focuses on risks occurring from meteorological hazards (i.e. extreme weather) and alpine hazards (e.g. avalanches, torrential processes, debris flows). The main idea of partnerships following this precautionary strategy is to gather and exchange information in order to better evaluate risk situations. Herein, a key element is the weather monitoring and early warning system called Infra:Wetter, which is jointly operated by the multi-sectoral partnership (MSP), as defined in [5], between ÖBB and the private weather service Ubimet GmbH. Also information from the national meteorological office (ZAMG) is included in this system. Besides providing individualized and route-specific warnings to approximately 1500 users, Infra:Wetter is also used to identify so-called critical meteorological conditions (CMCs) in advance: weather conditions that potentially lead to larger disruptions of train traffic and thus require coordinated action by the Natural Hazards Management Department of the ÖBB.

## 2 ENHANCE case study

As part of its commitments, ENHANCE brings in-depth study of the hazards through a detailed risk assessment for floods and debris flows at various locations for railway tracks. Furthermore, a comparison of the frequency of critical events with the number of floods and debris flows was done. Finally, an analysis of how improved risk information will influence the cooperation between stakeholders and decisions to close tracks, or to implement risk reducing protection measures.

### 2.1 Flood Damage Model: RAIL

Taking the core of partnerships on structural risk reduction measures into account, this ENHANCE case study focused on supporting strategic decision-making regarding structural protection measures via provision of valuable information on risks by means of a statistical modelling approach derived from empirical damage data, i.e. photo-documented damage on the Northern Railway in Lower Austria caused by the March river flood in 2006, and simulated flood characteristics, i.e. water levels, flow velocities and combinations thereof, as it can be seen in the Figure 2.

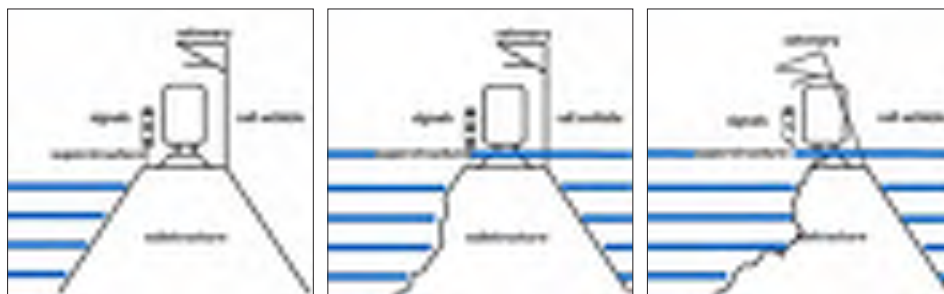


Figure 2 Damage classification scheme (adapted from [6])

A model was developed which will enable the estimation of 1) expected structural damage for the standard cross-section of railway track sections and 2) resulting repair costs. The first step in particular is usually skipped in existing flood damage models, since only (relative or absolute) monetary losses are computed. However, the localization of significant structural damage potentials at specific track section and, coupled therewith, the identification of risk

hot spots creates great added value for railway constructors and operators in terms of network and risk management. Such information allows, for example, the targeted planning and implementation of (technical) risk reduction measures. In this regard, the results of the risk assessment indicate that the model performance already proves expedient as the mapped results plausibly illustrate the high damage potential of the track section located closely adjacent to the course of the river March as well as a general accordance with inundation depths. The estimates of financial losses (i.e. repair costs) amount to a plausible order and scale as the total costs increase for lower probability events and the results for the flooding in 2006 only overestimate the real expenses by approximately 2 %. The findings, furthermore, show that the development of reliable flood damage models for infrastructure is heavily constrained by the continuing lack of detailed event and damage data. More details on the structural risk assessment results are presented in [2] and [4].

## 2.2 Non-structural Flood Damage Model

Since knowledge and information are the main focus of the partnership on the non-structural risk reduction measure *Infra:Wetter*, the case study at hand delivered new insights into possible climate change impacts on frequencies of extreme events to support decision-makers in the comprehensive and sustainable natural hazard management. After *Infra:Wetter* was established in 2006 in the aftermath of a major flood event in 2005, the system was stress-tested for the first time in June 2013, when extreme rainfall resulted in floods and debris flow events obstructing and interrupting train transportation in large parts of Austria. The event was predicted with a sufficient warning time and operational measures such as track closures and temporary speed limits reduced the risk to passengers and staff.

The frequency analysis of CMCs in a changing climate revealed a noticeable to strong alteration of the current hazard profile in Austria. Notwithstanding, the fact that climate change impacts can also have positive effects on some sectors (e.g. winter service), the occurrence of the most relevant type of CMC analyzed, i.e. very intensive rainfall events, is likely to increase significantly in future, which overall leads to new challenges for the ÖBB natural hazards management. If no action is taken, the costs due to extreme weather events must be expected to rise in future. An application of the risk layer approach, which evaluates the suitability of mitigation measures based on disaster risk characteristics shows that *Infra:Wetter* in combination with a risk absorption mechanism provided by the federal government is generally an appropriate solution to address the risk from CMCs.

Currently, CMCs are defined using a threshold approach, which was defined by experts of the MSP, i.e. ÖBB and Ubimet GmbH. Given the importance of these thresholds, potentially resulting in precautionary operational measures such as track closures and/or temporary speed limits, an empirical examination of these thresholds would provide important insights into the suitability of these thresholds. Therefore, a method to assess the suitability of the current thresholds is provided and exemplified. The modification of the thresholds for the identification of CMCs revealed that frequencies of extreme weather events are quite sensitive to changes of this decisive factor. In the context of climate change, this result emphasizes the importance to carefully define and constantly adapt and validate the thresholds in order to optimize the effectiveness as well as the adaptive capacity of a weather monitoring and warning system. For a real application of this method, a more detailed longitudinal damage data base would be required, though, highlighting the importance of event and damage documentation. Event documentation including “near misses” can enable risk managers to better understand and learn from historical events and, thus, to adapt natural hazards management according to future changes. More details on the non-structural risk assessment results are presented in [3].

### 3 Stakeholder impact

A central idea of the research conducted throughout the project was to respond to the specific needs and requests of the main stakeholder and the existing partnership, respectively. It started with a meeting with the main stakeholder ÖBB, whose support continued throughout the project. The goals were to 1) specify the concept and objectives of the case study, and 2) get an detailed overview of the stakeholder`s perspective, strategies and existing partnerships in the framework of hazard and risk management.

The main achievement of the risk assessment conducted in the context of structural protection measures (see Fig. 1) was the provision of the flood damage model RAIL [4]. The RAIL model can be used to estimate both structural damage to railway infrastructure exposed to flooding and related repair costs. This two-stage approach allows a consideration of both structural damage types and direct economic losses. Particularly the first step provides new information on the occurrence of specific flood damage grades at exposed track sections. These can then be used for different risk management purposes, e.g. for the planning of (targeted) technical protection measures. Hence, the tool has potential to support the stakeholder ÖBB in terms of e.g. conducting cost-benefit analyses or identifying risk hot spots along the entire Austrian railway network.

RAIL has only been applied to a test section, so far. The ÖBB signaled interest to apply the RAIL model on a larger scale to gain insights into hot-spots of risks of the entire network. A large scale risk assessment could provide important insights into priorities in terms of risk reduction measures. Detailed data on potentially inundated railway infrastructure in the Mur catchment were already provided and the assessment is currently in preparation. Furthermore, the ÖBB initiated discussions on how the RAIL model could be transferred also to other natural hazards than floods. The ÖBB would be especially interested in developing a similar method for debris flow events, for which hazard maps but no damage and risk model are available.

The research conducted in the context of non-structural protection measures focused on the analysis of effects of climate change on the frequency of meteorological extremes (see Fig. 1). The new insights on potential future changes of CMC frequencies due to climate change and related implications for railway transportation in Austria gained from the ENHANCE case study research is seen by the stakeholder as a significant benefit. The results can support the development of targeted adaptation strategies for railway infrastructure and service. The stakeholder and partners agree that given the importance of such thresholds, an empirical examination of thresholds defined by expert judgment would further substantiate their adequacy, providing important insights for the MSP on weather monitoring and early warning. For such an empirical validation, a detailed and long-term damage data base would be required. However, such longitudinal data bases with a high level of detail in terms of damage due to natural hazards are currently not available for railway infrastructure in Europe. Hence, the application of the approach using currently available event and damage data for railway infrastructure would not allow drawing certain conclusions regarding the validity of the specific thresholds currently applied in *Infra:Wetter*.

In addition, the ÖBB was interested to gain further insights into indirect damage arising from natural hazards. Indirect damages occur if train services are disrupted or delayed because parts of the railway infrastructure are blocked or destroyed, for instance, through a debris flow event. It was initially planned to model these effects by means of an “availability analysis” of the network on the basis of the graph theory. This approach has been successfully applied for cross overs and even larger railway stations (see [10]) but, unfortunately, it does not really cover the complexity of dependent natural hazards along a railway line. Hence, due to this complexity as well as lacking data, this assessment could not be realized within the term of the case study at hand.

## 4 Conclusion

In conclusion, by analyzing existing processes and combining them with new risk projections, ENHANCE provided a robust handgrip to secure current and future resilience in the Alpine railway lines whilst paying attention to costs shared by the different actors. The results of this project have provided improved knowledge for decision-making with a broader approach than the commonly applied cost-benefit analysis, by applying a multi-criteria analysis. This is of great importance since the hazard situation will not be static, due to climate change. Most importantly, the ÖBB also became aware of the fact that damage documentation system does not exist on a European level and is already focused on developing one. As a result, there will be a possibility for sharing knowledge and experiences on international level and Austria will become a “good practice example” when developing innovative tools for natural hazard management strategies on European level.

## References

- [1] Kellermann, P., Bubeck, P., Falter, D., Kundela, G., Schönberger, C., Kirnbauer, R., Schöbel, A., Thieken, A. H.: Deliverable 7.4: MSP Evaluation – Case study: Building railway transport resilience to alpine hazards. Report of the ENHANCE project. Available online at [www.enhanceproject.eu](http://www.enhanceproject.eu), 2015.
- [2] Kellermann, P., Kirnbauer, R., Schöbel, A., Kundela, G., Otto, A., Thieken, A.: Deliverable 7.3: Risk assessment results – Case study: Building railway transport resilience to alpine hazards. Report of the ENHANCE project. Available online at [www.enhanceproject.eu](http://www.enhanceproject.eu), 2015.
- [3] Kellermann, P., Schöbel, A., Kundela, G., Thieken, A. H.: Estimating flood damage to railway infrastructure – the case study of the March River flood in 2006 at the Austrian Northern Railway, *Nat. Hazards Earth Syst. Sci.*, 15, 2485-2496, doi:10.5194/nhess-15-2485-2015, 2015.
- [4] McLean, L., Heudtlass, P., Sapir, D., Mániz Costa, M., Carmona, M., Gee, K., Gerkenmeier, B., Ratter, B., Botzen, W., Aerts, J., Hudson, P., Veldkamp, T., Mechler, R., Timonina, A., Willeges, K., Surminski, S.: Deliverable 2.4: Framework Report as Guidance for Case Studies. Report of the Enhance project. Available upon request by authors., 2013.
- [5] Moran, A. P., Schöbel, A., Thieken, A. H.: Analyse des Hochwasserrisikos von Eisenbahninfrastrukturen, alpS project 1.19ABC – Final Report, Innsbruck, unpublished, 2010.
- [6] ÖBB-Infrastruktur AG: Geschäftsbericht 2013. ÖBB-Infrastruktur AG. Wien, 2014.
- [7] Otto, A., Kellermann, P., Kirnbauer, R., Kundela, G., Meyer, N., Rachoy, C., Schöbel, A., Thieken, A. H.: Deliverable 7.2: Development of MSPs – Case study: Building railway transport resilience to alpine hazards. ENHANCE project report. Available at: [www.enhanceproject.eu](http://www.enhanceproject.eu), 2014.
- [8] Schöbel, A., Blieberger, J.: Availability Analysis for Railway Infrastructure based on Graph Theory. EURO – Zel 2010, Zilina; 26.05.2010 – 27.05.2010; in: Revitalisation of Economy. New Challenge for European Railways. EDIS Zilina. pp. 141 – 148., 2010.
- [9] Thieken, A., Otto, A., Kellermann, P., Schöbel, A., Kirnbauer, R.: Deliverable 7.1: Risk Profile of Case Studies – Building Railway Transport Resilience to Alpine Hazards. In: Mysiak, J.: Risk Profile Case Study Using Conceptual Framework: Executive Summary. Report of the ENHANCE project. Available upon request by authors., 2013.



## ECODRIVING POTENTIALITY ASSESSMENT OF ROAD INFRASTRUCTURES ACCORDING TO THE ADEQUACY BETWEEN INFRASTRUCTURE SLOPES AND SPEEDS LIMITS

Alex Coiret<sup>1</sup>, Pierre-Olivier Vandanjon<sup>1</sup>, Ana Cuervo-Tuero<sup>2</sup>

<sup>1</sup> Ifsttar, France

<sup>2</sup> University of Oviedo, Spain

### Abstract

The energy associated with the use of road infrastructure exceeds in few years the energy needed for its construction. The link between infrastructure and use energy has not been, however, studied in depth, particularly as the legitimate transport societal expectations are related to efficiency and safety. However, we can consider reducing the energy use by working out minor optimizations of the road infrastructure itself, which is a major challenge in a context of overall decrease of resources and increasing pressures on the environment.

Experimental work is carried out here to develop one of these optimizations by improving the eco-driving potential of roads. It is based on the adequacy between vehicles dynamics, the road longitudinal profile and the speed sectioning of the infrastructure. This sectioning corresponds to the succession of speed limitations (road signs, roundabouts, intersections...). It may allow drivers to eco-drive or not, depending on dynamics, slopes, and secondary parameters as driver reaction time or distance of visibility. Optimal speed sectioning aims to limit the mechanical braking needed by potential energy reduction, due to slopes, which can be encountered simultaneously with the needed kinetic energy reduction.

Evaluation has been made on actual road sections, while recording both vehicle dynamics, driver commands, road signs positions and road longitudinal profile. Results show that energy consumption of vehicles approaching a speed reduction sign can be reduced by moving backward this sign of about 700 meters, without penalizing the primary safety function. The associated gain, for this optimization, has been evaluated to 14 liters of fuel per day for one of the experimental sites, considering traffic data. Application of this method on a network could then lead to considerable energy saving by allowing eco-driving.

*Keywords: Eco-design, Eco-driving, energy consumption, use phase, road infrastructure, longitudinal profile, vehicle dynamics, full-scale experiment, public policy*

### 1 Introduction

Roads have mainly been designed by considering criteria of safety, mobility and cost. Up to now, researches focused on these criteria have contributed to the enhancement of roads [1], [2], [3], but it has often been done regardless of the energy aspects of the infrastructures. Nowadays, constraints on resources availability and environment issues have also to be taken into account for infrastructure design or exploitation, in the aim to minimize energy consumptions needed to construct, maintain and operate infrastructures. In Europe, transport systems require a large part, 32%, of the global energy demand [4]. Furthermore, 81% of the transportation used energy is consumed by road transport [5]. Reducing this energy demand is then a key point in fossil resources savings and to mitigate the associated impacts of air pollution [6].

Many countries have promoted Eco-driving as a key element of national strategies to reduce GWP emissions (see for example the european project Ecodriven). However, these research efforts focus on drivers and cars but not on the infrastructure.

Without altering safety and with small concessions to costs and efficiency, alternatives designs of roads can lead to variations of operation phase consumptions, which represent the energy used by the vehicles traveling on them. Slopes and speed limits are the most evident design or management parameters which can influence significantly operation phase energy consumptions [7], [8].

The originality of this work is that it focuses on the conjunction of vehicle speed limits, vehicle dynamics and infrastructures slopes, whereas most of preceeding works have addressed theses parameters separatedly. Energy consumption linked to of the infrastructure operation phase is considered here, regardless of other contributing phases as construction and maintenance, since our aim is focused on the exploitation of the infrastructure, in a first stage.

## 2 Experimental phase

### 2.1 Methodology and setup

Several experimental campaigns have been done with a lightly instrumented vehicle on various secondary roads. 3D Vehicle positions are acquired at a fixed frequency of 1Hz with the help of a GPS Usb module “Garmin” and the “gpspipe” command on a linux-based computer (Fig. 1). High resolution pictures have been captured at chosen instants, corresponding at the perception time and passing time of each road sign. As the computer clock is synchronise with the GPS time, pictures have been afterwards geotagged with the help of a GPS correlation algorithm.



**Figure 1** Simple experimental setup; linux-based acquisition computer, Usb GPS module (upper-left), Carl Zeiss Hd1080 camera (upper-right)

Fig. 2 exhibits the acquired data for the particular campaign that is used in this paper. Fig. 3 shows that the GPS precision in space and in frequency is rather satisfying, considering the relatively low speed of the vehicle and the dimensions of the road infrastructure details. Indeed the



plotted GPS trace under the Geographical Information System “GpsPrune” is rendering correctly the roundabout visible in the map given in the right part of the figure. Fig. 4 given a large-scale rendering of the 3D GPS trace, as a primary verification of the vertical measurement quality.



Figure 2 Experimental travelled path around Nantes (GPS trace in blue, taken geotagged photos indicated in yellow)



Figure 3 Left: GPS trace Geographical Information System; right: Map

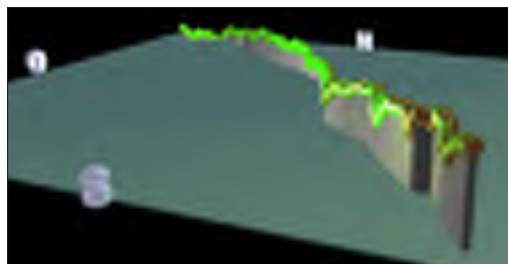


Figure 4 Rendering example of the 3d trace (50x-enhanced Z component)



### 3 Energy assessment

#### 3.1 Eco-driving potentiality

In this section, we will consider the crossing of the small village “La Brossière”, as depicted in Fig.5. The village is represented in grey on the map and the elevation graph gives first information on the fact that this village is in a “bowl” situation (ie; both of the two village entrances present rather high downhill slope). 16 pictures have been recorded while crossing the village in the two directions, north to south and then south to north. For situating this, these pictures are represented by the southeast yellow points in the Fig.2, near the “A87” label.



Figure 5 Experimental car entering in “La Brossière” (and map/elevation)

These geotagged photos can be departed on two sets as presented in Fig. 6 on the GPS trace. Each set, for each travelled direction  $D_1$  and  $D_2$ , correspond successively to: the view of the village entrance sign, the crossing of this sign, the view of a sign signalling the entering in a 30 km/h limit zone, the crossing of this sign, view of the ending sign of the 30 km/h zone, its passing position, and finally pictures at first viewing time and passing time positions of the village exit sign. For this considered experimental case of a village in a “bowl” configuration, the necessity to use mechanical brakes for conforming to speed limits is highly probable. For energy consumptions of vehicles, it is clear that it is preferable to decrease speed without braking, by anticipating and avoiding to use energy in excess before reaching the point of speed limit; mechanical braking is a waste of precedently unnecessary used energy, in the form of heat. Resort to mechanical braking due to a road sign depends on several parameters:

- road sign sight distance, that is influenced by road curvatures or slopes;
- altitude difference between the sign and the position of its viewing by drivers;
- the reduction in speed imposed by the road sign;
- the level of rolling resistance and aerodynamical resistance of each vehicle;
- the perception-reaction time of the driver; its behavior.

Ecodriving potentiality of a road infrastructure, around a point of change in speed limit, could then be associated in first approximation to differences in speed, difference in altitude, independantly of specific vehicle characteristics as advancement resistance.

Considering a given vehicle with a  $M$  mass, traveling at  $V_1$  speed at the position  $P_1$  of altitude  $h_1$  at which a road sign becomes visible. If the road sign impose the speed limit of  $V_2$ , at the position  $P_2$  of altitude  $h_2$ , the kinetic energy to lessen is;

$$E_c = 1/2M(V_1^2 - V_2^2) \tag{1}$$

Besides that, its variation of potential energy is;

$$E_p = Mg(h_1 - h_2) \tag{2}$$

with  $g$  the gravity acceleration, taken equal to  $9.81 \text{ m/s}^2$ .



**Figure 6** GPS trace and geotagged pictures taken while crossing the “La Brossière” village in the two  $D_1$  and  $D_2$  directions

As an infrastructure-related indicator of eco-driving potentiality, we choose to retain the ratio between the potential energy to the sum of potential and kinetic energy. Indeed, a positive

potential energy (downhill) is less favorable than a negative one (ascent) to avoid the resort to mechanical braking. We define this ratio as the following gain criteria  $G_{opt}$ ;

$$G_{opt} = \frac{E_p}{(E_p + E_c)} = \frac{Mg(h_1 - h_2)}{Mg(h_1 - h_2) + 1/2M(V_1^2 - V_2^2)} = \frac{1}{1 + \frac{1/2(V_1^2 - V_2^2)}{g(h_1 - h_2)}} \quad (3)$$

This criteria depends only on the speed sectionning and road signs positions and is easy to compute. In our application case, for the positions labelled “D<sub>2</sub> – Entry – View” and “D<sub>2</sub> – Entry – Sign” in the Fig.6, numerical datas are:

- the distance between the two positions is of 300 meters. Nethertheless this distance does not contribute to this first step of road network evaluation with the  $G_{opt}$  criteria;
- the respective altitudes are 189.7 m and 178.7 m (difference of 11 meters);
- the speed has to be reduced to 50 km/h from 90 km/h (reduction of 11.11 m/s).

This case (see Fig.7) is then associated to a high potential energy equal to 49.9 % of the kinetic energy. The  $G_{opt}$  gain is then equal to 33%, that is to say that the potential energy is equal to the third of the total energy that has to be cut down (potential and kinetic).

Another example can be considered: between the positions labelled “D<sub>1</sub> – Z30<sub>en</sub> – View” and “D<sub>1</sub> – Z30<sub>ex</sub> – Sign” (Fig.6), altitudes are of 181.6m and 179.6m, speed has to be reduced to 30km/h from 50 km/h, potential energy equal to 31.8% of the kinetic energy and  $G_{opt}$  is equal to 24%.

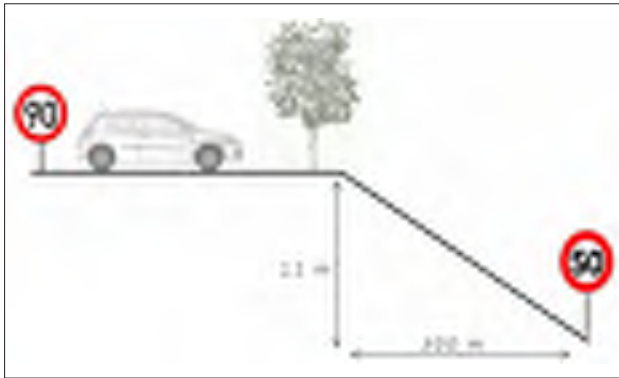


Figure 7 Test case: deceleration imposed in descent

### 3.2 Energy assessment

In order to assess the energy gains associated with the  $G_{opt}$  eco-driving criteria, we have modeled the energy losses by aerodynamic drag and rolling resistance for specific test vehicle, a Renault Clio III. The computation of these energy losses are performed by considering that the driver releases the acceleration pedal (coasting phase) as early as he sees the sign of the limitation speed. In this phase, the fundamental dynamics leads to the following differential equation between the speed and the resistance forces:

$$\dot{v} = \left( \frac{1}{2} C_x S_x v^2 + Mg(C_{rr} + \sin(\alpha)) \right) / M \quad (4)$$

With  $C_x$  the aerodynamical coefficient, equal to 0.32,  $S_x$  the vehicle frontal area equal to 2.25 m<sup>2</sup>,  $C_{rr}$  a fixed rolling resistance coefficient equal to 0.1,  $\alpha$  the mean longitudinal slope.

Eq.4 has been solved numerically, yielding to the computation of speeds and positions, energy losses being the work of the resistance force. For the precedently selected test case at “La Brossière”, with a sight length of 300 meters, a 11 m difference in altitude and a 11.11 m/s requirement in speed reduction, the mechanical braking need is of 246.9 kJ. With a road sign placed 700 m upstream, this requirement would be lowered to 139 kJ.

Considering standard daily traffic datas in terms of light and heavy vehicles, these two braking energy can be converted in fuel equivalent costs of respectively 44.7 and 30.7 liters. Practically, in this case, the displacement of a simple road sign could lead to a daily gain of 14 liters of fuel and roughly 34 kg CO<sub>2</sub> emissions. The accuracy of these results could be improved by using several car models and by refining the traffic estimation. However, the actual investigations proves the significant fuel saving achievable by the displacement of a single road sign.

## 4 Conclusions

This work focused on the use phase of road transportation. It highlights that if potential energy has to be reduced in the same time that kinetic energy, due to the presence of a road sign for example, ecodriving could not be allowed and drivers could be force to resort to mechanical braking. Experimental work based on the adequacy between vehicles dynamics, road longitudinal profile and speed sectioning of the infrastructure has allowed to identify points of road network for which a chosen indicator points out an ecodriving potentiality issue. A further energy assessment at one of these points has shown that energy consumption of vehicles approaching a speed reduction sign can be reduced by moving backward this sign of about 700 meters, without penalizing the primary safety function. The associated gain, for this optimization, has been evaluated to 14 liters of fuel per day for one of the experimental sites, considering traffic data. Application of this method on a network could then lead to considerable energy saving by allowing eco-driving.

## References

- [1] Esposito, T., Mauro, R., Russo, F., Dell'Acqua, G.: Speed prediction models for sustainable road safety management. *Procedia Social and Behavioral Sciences* 20, pp. 568-576., 2011.
- [2] Tingvall, C., Stigson, H., Eriksson, L., Johansson, R., Krafft, M., Lie, A.: The properties of safety performance indicators in target setting, projections and safety design of the road transport system. *Accident Analysis and Prevention*, pp. 372-376., 2010.
- [3] SETRA, 2000. ICTAAL: Instruction sur les conditions techniques d'aménagement des autoroutes de liaison. ISBN 2-11-091797-0, Editions du SETRA. 58p.
- [4] Baptista, P.C., Silva, C.M., Farias, T.L., Heywood, J.B.: Energy and environmental impacts of alternative pathways for the portuguese road transportation sector. *Energy Policy* 51, pp. 802-815. *Renewable Energy in China.*, 2012.
- [5] Monzon, A., Sobrino, N., Hernandez, S.: Energy and environmentally efficient road management: The case of the spanish motorway network. *Procedia – Social and Behavioral Sciences* 48, pp. 287-296. *Transport Research Arena*, 2012.
- [6] Mukhopadhyay, K., Forssell, O.: An empirical investigation of air pollution from fossil fuel combustion and its impact on health in india during 1973–1974 to 1996–1997. *Ecological Economics* 55, pp. 235-250., 2005.
- [7] Roumegoux, J.P.: Calcul des émissions unitaires de polluants des véhicules utilitaires. *Science of The Total Environment* 169, pp. 205-211. *Transport and Air Pollution.*, 1995.
- [8] Coiret, A., Vandanjon, P.O., Bosquet, R., Jullien, A.: Energy consumption induced by operation phase of railways and road infrastructures. 2<sup>nd</sup> International Conference on Road and Rail Infrastructure. 7-9 May 2012, Dubrovnik, Croatia.





## EVALUATION OF INFRASTRUCTURE CONDITIONS BY 3D MODEL USING DRONE

Hiroyuki Miyake, Makoto Fujiu, Shoichiro Nkayama, Jyunichi Takayama  
*Kanazawa University, Department of Civil Engineering, Japan*

### Abstract

Recently, a fantastic view and a bird view is easy to be taken a movie by the drone. Especially, the 3D models can be created using the movie which is taken by the drone easily. This time, the created 3D models of the road are analyzed multilaterally in this study. The purpose of this study is to evaluate a safety of the road because 3D model is able to express structures on the road, slopes and fillings. At first, two situations road are taken the movies by the drone. One of two is slopes and fillings on the road. The other is a bridge above the road. The ways of taking the movie are an overall image of the pickup road and limiting a photographing range. The filmed movies convert 3D models by agisoft photoscan. It depends on time of movie, it takes more than seven hours to create high quality 3D model. As a result of this study, it became clear that unusual point and changes out of sight was discovered by the 3D model which is structure on the road, slopes and fillings. An overall image of the pickup road of the 3D model which is compared regularly can be perceived changes and the model which is limiting a photographing range can be analyzed details. Also it is possible that taken difference between the current 3D model and the past that can be offered an insight into any signs. In this way, the 3D model is useful to evaluate a safety. And it is one of the easy ways to survey and inspect the road.

*Keyword: drone, 3D models, agisoft photoscan, inspect*

### 1 Introduction

These days, the drone is able to be used easily for anyone. By flying it can film a fantastic view from the air and get a dramatic movie. The drone's (use PAHNTOM3 Professional) features are a stable hovering function and loading the 4K image quality of a camera. Since it is no influence of wind, it is possible to easily operate. Also it can fly more advanced one hundred meters, be safely operated until about one kilometer away.

The drone is expected to use infrastructure inspection such as bridges and structures, since it can shoot out of sight usually. Most of the infrastructure equipment in Japan is damaged such as cracks and distortion by aging [1],[2]. Therefore, it is essential to construct ways of efficient inspection and evaluation. The purpose of this study is examination of construction about how to extract the degradation by the drone and evaluation of itself. With this, it is necessary to meet the required performance about inspection of infrastructure equipment. It is safety for the inspection maintenance. It is easily and sensuous ways. It is efficiency of being able to check a lot of infrastructure equipment in less time. It is correct and economic. These required performance are necessary to achieve for inspection of infrastructure henceforth. In this study, there is an aim to verify whether a practical way while satisfying the performance. In order to build technique, the data of bridge girder and structure wall set to target mainly. Since damage, such as cracks can be determined fundamentally by eye, taking difference

between the current condition and the past that can help to grasp where there is unusual point. In this study, damage of interest handle only cracks which are important and representative for inspection of concrete structure. In terms of cracks, they are small to large things which are impact on the structure. Although large cracks can be discriminated by eye, small things are difficult to capture in the shooting of drone. In case of shooting closely, there is a risk of contact with the structure. The drone is a manned operation in the present circumstances, and some risk due to human error is fraught surely. As outlook, if the drone can set a flying route, a flying speed and shooting angle, the target structure can be observed in the same every time and be compared accurately. But the photographing by the drone is a manned operation, an error of data occurs. Also the same data does not get in case of canged shooting date and shooting time in the same object. So it is necessary to consider it from now on. Various previous studies are refered to this study [3],[4]. For example, there are many ways to automatically extract the cracks. But a different point of previous studies in this study extracts deterioration by taking different between images. As outlook, it is a goal to extract by taking different between 3D models. Up to now, there is a way to recognize deterioration in automatic. The feature of this study is a recognition how degree of progress of damage by subtraction. Furthermore, this study is a trial method to establish extraction ways by taking different between 3D models.

## 2 Data

### 2.1 Research data

The data of this study is 3D models which created using SfM technology based on video taken by drone. Actually, the target is 2D, that is dealing with the image. The software called agisoft photoscan is used for data creation. The flow of data creation is shown in figure 1. 3D models are necessary to consider shooting methods and shooting points for the required inspection point. For example, cracks of bridge piers should be taken a video closer. Also, the shooting from a variety of viewpoint is important in order to express the relief such as slope and filling.

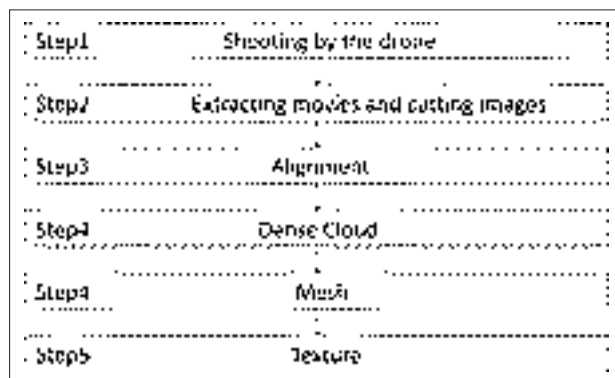


Figure 1 The flow of data creation

### 2.2 Research method

Figure 2 shows the verification procedure of data. The configuration of the procedure is a five stage:

- 3D models of target structure are created according to Figure 1. They are evaluated whether they can be made accurate, the shooting repeats to get high accuracy of data if there is an

unclear part. To verify that the deterioration such as cracks are incorporated in accurately in the 3D models.

- The obtained data processes the 3D to 2D. It is careful so that the compared images must be considered to make the same quality.
- To take different between the current images and the past that are compared. Part that does not overlap the image is a feature point that degradation is obtained by the subtract.
- To verify whether the deterioration can be extracted.
- The obtained result is evaluated whether that is significance.

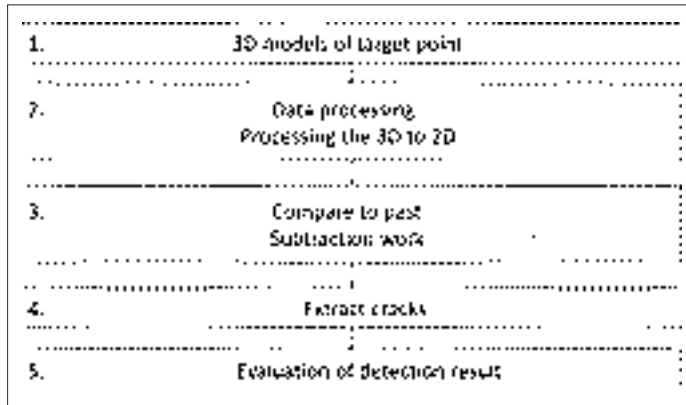


Figure 2 Verification procedure

### 3 Analysis and result

#### 3.1 Data creation

The images of analysis show in Figure 3. It is assumed to be two patterns. (a) in Figure 3 is a wholesome wall with no pseudo damages. (b) in Figure 3 is a unwholesome wall with pseudo damages. In this study, pseudo-deterioration is deliberately larger than the real that for verification.

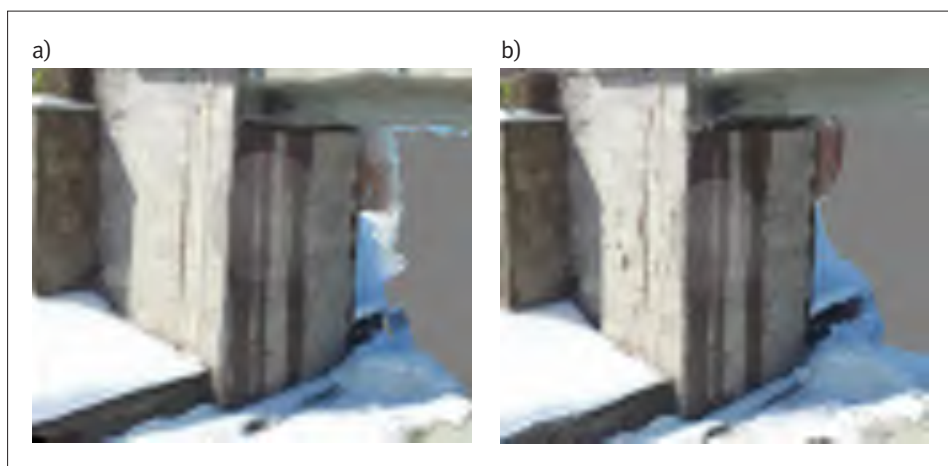


Figure 3 The target model images of verification



Figure 4 shows the shooting route to get the target data. The point of interest is pier in bridge of Kanazawa University. The shooting date is January 26, 2016 by PAHNTOM3 Professional. The video time is about 1 minute. By photographing the 2 pattern as (a) and (b). The shooting accuracy is relatively well, sufficient data is obtained.



Figure 4 The shooting route

### 3.2 Analysis of verification

With Figure 3, it is carried out subtraction processing by Photoshop. Figure 5 shows a image after the subtraction. The black portions of the image are dyed black so that RGB values are the same. This corresponds to portions with no changes. Also, white portions happens some sort of changes. This shows that RGB values are not identical.



Figure 5 A image after the subtraction processing

Figure 6 shows that it is an enlarged view of extracted changes. The points which are surrounded by red circles correspond to the extracted pseudo-degradation and damage. This subtraction processing shows how about the extent of the damage is in progress. But it is not able to extract the degradation only because it detects the distortion of the data itself. Also, the detected damages are much larger than the real damages in this time, it is necessary to extract actual cracks from now on.



Figure 6 The extracted changes and distortion of data itself

## 4 Conclusion

In this research, although it succeeded in extracting the pseudo deterioration and damage, the result remains some challenges whether this method can be applied to actual cracks. The future prospects are expected to extract deterioration such as cracks actually by the automatic flying drone and compare 3D models. It is also necessary to consider the subdividing of flow so that it can be applied to an actual inspection.

## Reference

- [1] Irizarry, J., Gheisari, M., Walker, N.B.: Usability assessment of drone technology as safety inspection tools, *Journal of Information Technology in Construction*, ISSN 1874-4753, 2012
- [2] Shozo Nishimura, S., Kimoto, K., Matsuoka, N., Otani, H., Ogata, T., Matsuda, H.: The Development and Evaluation of Telemetry in Bridge Maintenance, *Journal of applied survey technology*, 2013
- [3] Fujita, Y., Nakamura, H., Hamamoto, Y.: Automatic and exact crack extraction from concrete surfaces using image processing techniques, *Japan Society of Civil Engineers F*, 66(3), pp. 459-470, 2010
- [4] Kawamura, K., Miyamoto, A., Nakamura, H., Sato, R.: Proposal of a Crack Pattern Extraction Method from Digital Images Using an Interactive Genetic Algorithm, *Proceedings of JSCE (742)*, 115-131, 2003-09-20





## A LOCAL AUTHORITY'S RISK-BASED APPROACH TO PRINCIPAL INSPECTION FREQUENCY OF STRUCTURES

Gary McGregor<sup>1</sup>, Slobodan B. Mickovski<sup>2</sup>

<sup>1</sup> *Engineering Design, Development Services, Falkirk Council, Scotland, UK*

<sup>2</sup> *Glasgow Caledonian University, Scotland, UK*

### Abstract

Scotland's bridges are an integral part of its infrastructure, therefore it is imperative that they are inspected and maintained correctly. Current standards state that general inspections (GI's) are carried out every 2 years and principal inspections (PI's) every 6 years. This study examines a risk-based approach to principal inspection frequency and development of a tool for relevant structures. The current inspection practices were investigated with regards to the research behind the existing inspection intervals. A full literature review was carried out on a number of case studies and documents to ascertain all options that could be utilised for a risk-based approach of this type. The major factors that could affect the structural stability of highway structures were explored and a shortlist of factors was finalised. These factors were weighted against each other, e.g. Bridge Condition Index (BCI<sub>crit</sub>) weighted higher than span length of the structure. Individual variables were researched for each factor and rated in accordance to perceived risks. All factors are used and an inspection frequency score is output from the assessment as well as a risk score for the structure. The results presented will assist the Bridge Manager of a Local Authority (LA) to organise PI's on each structure within their stock based on its risk profile. Engineering judgement and knowledge of the structures will require to be used to complete the assessment tool for risk-based approach to PI frequency of structures. The main benefits of establishing a risk-based principal inspection frequency are reduced cost, higher level of safety and best value optimisation of resources.

*Keywords: Risk, inspection, frequency, reliability, local authority, structures*

### 1 Introduction

In Scotland there are thirty two Local Authorities (LAs) all of which have the responsibility of managing their assets. For the purpose of this study, highway structures, such as bridges, are defined as 'assets' (The Highways Agency, 2007). The nation's road and railway bridges are an integral and critical part of its infrastructure; therefore it is important that they are inspected and maintained correctly. The current economic downturn has promoted ways of thinking to manage assets in a more economical way. With relative budget and resource cuts within the local authorities (Local Government Association, 2014), the need for innovation and a new approach is necessary.

The LAs in Scotland currently carry out General Inspections (GI's) of their structures every two years, with Principal Inspections (PI's) scheduled every six years (The Highways Agency, 2007). The purpose of inspections is to provide suitable information for the asset manager to plan future maintenance, intervention, funding and to ensure the structures are fit for purpose and safe for use (UK Roads Liaison Group, 2013).

Inspections are perceived in the civil engineering industry as the best way to evaluate structures, along with assessments (Wang & Foliente, 2008). An inspection requires a competent inspector or engineer to score each element of a structure to obtain its condition rating. An assessment of a structure uses numerical data to analyse its load carrying capacity and its condition (Design Manual for Road and Bridges, 2001).

In Scotland, structures such as the Forth Bridge or Clackmannanshire Bridge are nationally important local bridges which form an integral and critical part of the highway infrastructure and therefore require suitable inspection and maintenance. Many bridges carry a vast amount of traffic each day, carrying vehicles across rail, road and water. The highway trunk roads in Scotland are currently maintained by Scotland Transerv, Amey and Bear on behalf of Transport Scotland. Bridge asset owners such as Network Rail, Scottish Canals, BP, etc all maintain structures which can be on the list of public roads but are their asset. Local Authorities within Scotland maintain all other adopted public roads.

The purpose of this paper is to determine the Principal Inspection frequency according to the risk profile of an individual structure in an attempt to help the asset managers in the LAs with scheduling and prioritising the PIs. To achieve this, we review current standards for inspection along with existing literature, consult Scottish LA bridge managers, and create a risk assessment tool which is easy to use and fulfils its purpose.

## 2 Background

All Local Authorities in Scotland have the statutory duty (BD63/07) to undertake a Principal Inspection of every structure within six years of its last PI (The Highways Agency, 2007). Principal inspection intervals can be decreased if agreed by the Overseeing Organisation with full documentation for the reason (The Highways Agency, 2007). The intervals can also be increased through a risk assessment, but cannot exceed twelve years (The Highways Agency, 2007). Falkirk Council, one of the 32 LAs in Scotland, is liable to inspect 356 structures in total with approximately 45 PI's every financial year on the structures that are owned by the LA. Three engineers are tasked with this, which equates to approximately 15 structures for each member of staff. A small number of structures are owned by Falkirk Council that cross the railway network which require closures to that network during inspection. This means additional costs for temporary works as well as a fee payable to the Railway Asset Manager for each railway possession. In the past, this fee has been above £6,000 for the possession, excluding labour, plant and access costs, which prove to be a heavy burden on the decreasing budget of the LA. Falkirk Council is responsible for 40 structures which are deemed to be confined spaces. These are structures that are partially enclosed or cannot be entered and exited safely by any person. These structures require the term consultant to inspect these to the same intervals as the remainder of the LA's structure stock and charge £900-£1,300 per structure, depending on the method of inspection, ranging from CCTV camera inspection to mobilisation of a full confined space inspection team. The above shows that public spending cuts are increasing and local authority budgets as well as staffing levels are decreasing. These factors are some of the major driving forces for change to provide a more economical approach to bridge inspection. On the other hand, the current standards and guidelines (UK – BD63/07 (2007), Management of Highway Structures: ACoP (2013), Inspection Manual for Highway Structures (2007)) all prescribe GIs in 2 year intervals and PIs in a 6 year intervals without detailing the background research and rationale for the interval length. The above current UK standards and guidelines do not include for the history of the structure, i.e. previous defects and repairs.

The Interim Advice Note IAN 171/12 (Highways Agency, 2012) aimed at risk-based inspection intervals in England, was accompanied by a questionnaire for stakeholders to use when establishing their Principal Inspections. However, the IAN lacked suitability in analysing the likelihood of a potential risk.

Many other industries began using a Risk-Based Inspection (RBI) framework (Yang & Trapp, 1974) and (Faber et al, 1996) for inspection a long time ago, and it seems we may be behind the times in this respect. TWI and Royal & SunAlliance Engineering (1999) analysed the RBI framework for plant such as pressure systems and storage tanks which are also structural assets. This trend towards risk-based analysis is becoming common practice in many disciplines and it is now necessary to establish a standard for RBI frequency for our structures.

### 3 Methodology

A mixed method approach was used to achieve the aims and objectives of this paper. With this methodology, use was made of contributions from both quantitative and qualitative research (Halcomb and Hickman, 2015). The primary qualitative data that was obtained was the individual factors that were to be used for highway structures on their risk profile. These were taken from various pieces of literature that have been written on the topic. A request to bridge managers of Scottish LAs to rank each factor from most to least influential on the risk profile of a structure was then carried out. The bridge managers were also asked to rank the variables within construction form and construction material in terms of reliability from their experience within the field. Fifteen responses were forward in the specified timescale from thirty four requested. Quantitative data was taken from Falkirk Council's WDM Bridges Database on all repairs carried out to a specific group of fifty structures. The research of existing literature assisted in sourcing individual factors that could be used to determine a structures risk profile with requested information very useful in weighting each factor. From this information a risk-based tool was created for use on all highway structures to identify an optimum inspection frequency. With both research methods showing limitations, it is thought that a mixed method approach is better rounded research and can give more accurate results by triangulating the research i.e. the weaknesses of each method will be counter balanced by the strengths of the others (Yin, 2004). Producing "a final product which can highlight the significant contributions of both" (Naoum, 1995).

When creating the risk assessment tool, failure was defined as "any situation when a bridge does not fulfil its performance expectations" (Bush et al 2011). Therefore, any bridge with a weight restriction placed upon it, should be prohibited from a risk-based inspection regime. Every structure with a weight restriction was assessed as not to be able to carry full HA/HB loading and was therefore unable to go through the framework.

To follow the current guidelines (County Surveyors Society, 2002), factors affecting the structures have been chosen based on research and each were weighted on their importance to the structures risk to determine inspection intervals for Principal Inspection. All input from the factors above will require to accurate and recent. To prioritise the factors and weight them will require engineering judgement and expertise, especially of the structures. That is why all relevant departments of all LAs in Scotland were consulted and their input included in the creation of the new tool.

### 4 Results and discussion

Thirteen of the thirty two local authorities returned the Research Requested information in the specified timescale. Two additional returns were completed by Chartered Engineers who are colleagues at Falkirk Council. One local authority currently does not have a bridges department. At the moment their inspections, assessments and maintenance is carried out by Falkirk Council who are under a term consultancy contract. One other local authority did not wish to participate as they felt it would not benefit their Council from utilising a risk-based principal inspection frequency.

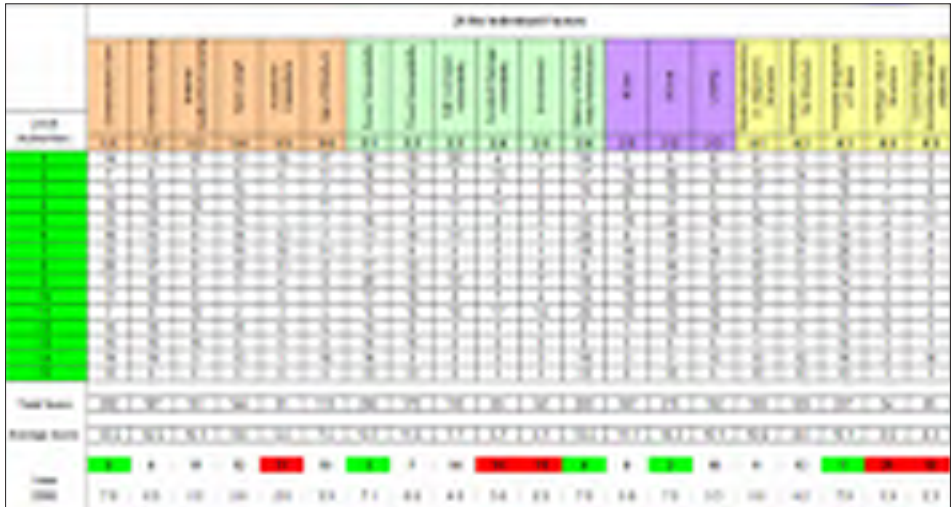


Figure 1 Importance ranking of bridge inspection factors in the opinion of 15 LAs

		% Weighting
Construction Form	1.1	7.0
Construction Material	1.2	6.5
Material Quality / Workmanship	1.3	6.2
Span Length	1.4	5.8
Access for Inspections	1.5	2.8
Age of Structure	1.6	3.3
Scour Susceptibility	2.1	7.1
Flood Susceptibility	2.2	6.0
Salt Corrosion Vulnerability	2.3	4.8
Accident Damage Vulnerability	2.4	3.8
Environment	2.5	2.2
History of Defects / Past Performance	2.6	7.8
BCIeq	3.1	5.8
BCIcr	3.2	7.5
Loading	3.3	5.3
Route Supported by or Adjacent to Structure	4.1	5.5
Obstacle Crossed by the Structure	4.2	4.2
Probable Magnitude of Failure	4.3	7.8
Heritage Value of Structures	4.4	1.9
Cost to Replace (including damage to adjacent)	4.5	2.3

Figure 2 Weighting table of individual factors for the risk pro forma

The response from each LA was tabulated and the results (values) were inverted to allow proper weighting of each factor (Figure 1). The initial format of the requested research was that the most influential factor on risk score of a structure was to be ranked as number one with the least influential ranked number twenty. All factors would then receive a number between one and twenty, depending on how the research participant (bridge manager) felt they ranked in terms of importance on the risk score of a structure. The research participants were asked to rank the factors from their experience in the industry and knowledge of their own structures. With all rankings being inverted, number one became twenty, number two became nineteen and so on until twenty became one. The rankings were inverted to give correct allocation of



weighting for each factor. The percentage of weighting of each individual factor would affect the risk score of a structure. My opinion felt that each factor influences the risk profile of a structure to varying degrees and this was why the weighting exercise was carried out. After ranking from each Scottish LA bridge manager, the factors used were weighted by totalling all fifteen responses for LAs. These were then portioned into weightings as a percentage of the total number of returns.

The results from the respondents show that the most influential factor is The Probable Magnitude of Failure and the least influential factor Heritage Value of the Structure (Figure 1). The probable magnitude of failure has the highest weighting of all the factors. The research participants as a whole have felt that this must be the most influential factor. This is more than likely due to the fact that different failure types and magnitudes can result in very different situations. If complete failure were to occur in a structure it is more than likely that loss of life may follow. The BCICrit of any given structure is also high in the rankings probably due to its obvious nature. The BCICrit of a structure states its condition out of one hundred which is easily understood. The current condition of a structure clearly has to be play a major part in its risk scoring, which has been confirmed through the research participants. The scour susceptibility has the third highest weighting with bridge managers in Scotland who are very knowledgeable about scour problems to their structures. The history of defects / past performance of the structure are factors that has been omitted from many risk-based analysis. These results have defined this as a major factor with the fourth highest weighting. This individual factor gives a clear indication of how the structure has coped since its construction. The fifth highest weighting is the construction form of the structure, which with individual knowledge and research on failures of certain forms can assist in analysing structures in terms of risk. The research participants were asked to rank the nineteen types of construction form in terms of reliability from their knowledge and experience of their bridge stock. The most reliable construction form from the research participants is solid spandrel arch, with cable stayed / suspension and other the least reliable (Fig. 3).

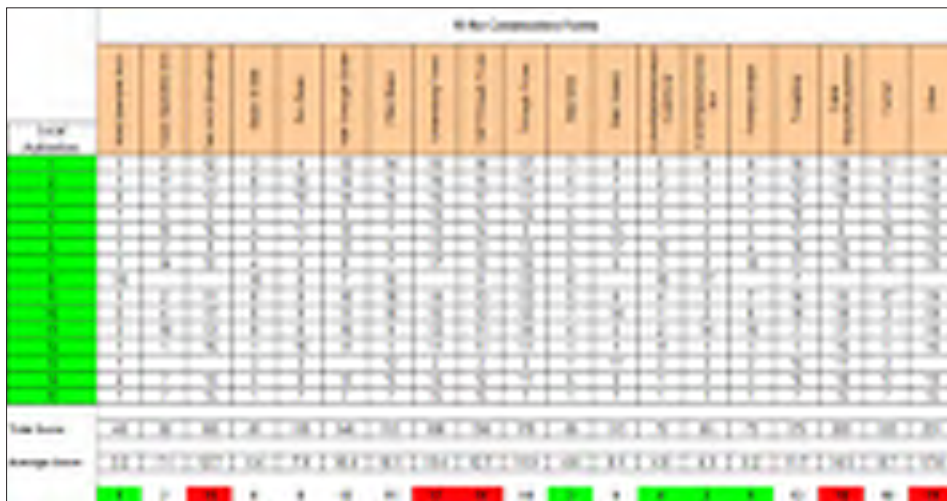


Figure 3 Risk ranking of bridge construction forms in the opinion of 15 LAs

As for Construction Form, the research participants were asked to rank the construction material. There were fourteen construction material variables. As shown in the table below, the most reliable construction material is masonry stone with the least reliable other and metal – cast iron.



		14 Risk Construction Materials													
		1	2	3	4	5	6	7	8	9	10	11	12	13	14
Local Authorities		1	2	3	4	5	6	7	8	9	10	11	12	13	14
1															
2															
3															
4															
5															
6															
7															
8															
9															
10															
11															
12															
13															
14															
Total Score		20	15	12	10	8	7	6	5	4	3	2	1	1	1
Average Score		1.4	1.1	0.9	0.7	0.6	0.5	0.4	0.3	0.3	0.2	0.1	0.1	0.1	0.1
		3	2	1	1	1	1	1	1	1	1	1	1	1	1

Figure 4 Risk ranking of construction materials in the opinion of 15 LAs

### 5 Conclusions

The aim of this research was to improve safety and optimise management of resources by determining the principal inspection frequency according to the risk profile of individual highway structures. To current practice, principal inspections are carried out on every highway structure on a six year regime.

The risk profile of highway structures has been identified to a certain degree of accuracy with the individual factors and weightings used. This could be enhanced by further research into the ratings of each individual factor and variable used. The risk-based tool, complete with user guide includes a complete flow chart for ease of use. Bridge managers in Scotland can input all twenty factors regarding each specific highway structure with the output an inspection frequency score. The score then gives an indication of inspection regime, in terms of frequency, that structure could be incorporated into.

The inspection frequency score of each highway structure is only an indication of inspection frequency, engineering judgement, along with a high level of experience of the structure should be used. Each bridge manager can adjust inspection frequency groupings to suit owned bridge stock.

### Acknowledgements

The authors would like to thank Falkirk Council for support and access to information, the LA bridge managers in Scotland for their help and assistance and, finally, family and friends for their continued support and encouragement throughout the study.

## References

- [1] The Highways Agency. 2007. Inspection Manual for Highway Structures. London TSO.
- [2] UK Roads Liaison Group. 2013. Management of Highway Structures, A Code of Practice. TSO.
- [3] Wang, X., Foliente, G.: Identifying bridge structural condition development trends via categorical inspection condition rating with case studies. Sustainable Ecosystems, Commonwealth Scientific and Industrial Research Organisation., 2008.
- [4] The Highways Agency. 2012. Interim Advice Note 171/12 Risk Based Principal Inspection Intervals.
- [5] Yang, J.N., Trapp, W.J.: Reliability analysis of aircraft structures under random loading and periodic inspection. AIAA Journal, 12 (12), pp. 1623-1630., 1974.
- [6] Faber, M.H., Kroon, I.B., Sorensen, J.D.: Sensitivities in structural maintenance planning. Reliability Engineering and System Safety, 51, pp. 317-329., 1996.
- [7] TWI and Royal & SunAlliance Engineering for the Health and Safety Executive. Best practice for risk based inspection as a part of plant integrity management. ISBN 0 7176 2090 5.
- [8] Bush, S., Omenzetter, P., Henning, T., McCarten, P.: A risk and critically-based approach to bridge performance data collection and monitoring. Taylor & Francis., 2011.
- [9] County Surveyors Society Bridges. 2002. Bridge Condition Indicators, Volume 1 Commission Report.
- [10] Halcomb, E., Hickman, L.: Mixed methods research. Nursing Standard. pp. 29, 32, 41-47., 2015.
- [11] Johnson, R.B., Onwuegbuzie, A.J., Turner, L.A.: Toward a definition of mixed methods research. Journal of mixed methods research. Vol 1 No 2, April 2007 pp. 112-133. Sage Publications., 2007.
- [12] Yin, R.K.: Mixed method research: are the methods genuinely integrated or merely parallel? Research in the schools, Spring 2006, Vol 13, Issue 1, pp. 41-47., 2006.
- [13] Nau, D.: Mixing methodologies: can bimodal research be a viable post-positivist tool? The qualitative report, online serial, 2(3)., 1995.
- [14] Design Manual for Road and Bridges. 2001. BD21/01 The Assessment of Highway Bridges and Structures. TSO.





## APPLICATION OF SENSITIVITY ANALYSIS FOR INVESTMENT DECISION IN BUILDING OF UNDERGROUND GARAGE

Suada Džebo

*University of Sarajevo, Faculty of Civil Engineering, Sarajevo, Bosnia and Herzegovina*

### Abstract

Sensitivity analysis is frequently used for investment decision in connection with the assessment of investment project in uncertainty conditions. The paper contains key parameters defined by application of sensitivity analysis in a model of discounted cash flow of project of underground garages. The analysis was done by varying individual input parameters from the minimum to the maximum assumed default value. The parameters identified as critical are those on whose change the profitability of the project showed to be particularly sensitive. Also, the paper contains individual effect of each critical parameter to the net present value of the investment over project time of 20 years. The analysis was done for four scenarios of garages of different capacities. The paper could be used in preliminary reviews and preparation of studies on options to resolve problems of parking demand in urban parts of cities.

*Keywords: sensitivity analysis, parking, underground garage, profitability*

### 1 Introduction

A parking space became the problem of almost all bigger urban areas. High-raisers and condensed content of other activities frequently require more parking spaces. It is a fact that a passenger car remains still over 90% of time. Therefore, securing standstill (car parking) conditions becomes starting condition for traffic system operation.

Increase of motorisation level caused greater demand for parking spaces. Lacking it more and more are being taken surfaces not intended for parking. As a consequence, it is not rare case that car owners use street parking in streets where it is not legally allowed.

Having this in mind, there is no doubt that parking present huge urban problem the solution of which implies a well thought out approach both in socio-economic and technical aspect. As space needed for standstill traffic greatly exceeds objective possibilities – i.e. city areas are already very busy due to other necessary contents – the construction of underground garages is seen as a possibility for partial solution of this problem.

Nevertheless, it is usually very difficult to ensure finances for construction of these garages in local communities' budgets. Therefore, a Public Private Partnership (PPP) Model is seen as a possible solution for financing the construction of such infrastructure objects. In other words, the contract stipulates obligations under a form of the PPP for a defined (contracted) period of time.

In order to be interested in investing a private partner must have financial return on investment within the project period. However, public garages are not being constructed for profit or financial gain, but because of chronic shortage of parking space in urban areas of the city. Financial analysis show that such investments return only in approximately ten years. The sole source of private partner income in this case is parking space payment. At the same time, according to parking policy, the local community's priority is to address the needs of

the residential customers. That is why the percentage of parking spaces for these customers has to be imposed as an obligation for the private partner. This per cent, however, greatly impacts the project profitability.

After the financial feasibility and sustainability is verified by the Discounted Cash Flow Model, it is necessary to define risks that are vital in making investment decisions. Namely, in calculation of Net Present Value (NPV) all parameters (i.e. cash flows, discount rate, interest rate and other) contain specific level of risk in assessment. Consequently, the NPV is a risk data itself.

## 2 Sensitivity analysis and definition of key parameters

The sensitivity analysis is a technique used to determine how different values of an independent variable will impact a particular dependent variable under a given set of assumptions. This procedure is often used in investment decision-making related to investment project evaluation under conditions of uncertainty. By applying this analysis it is possible to find the maximum or minimum points of a value while the investment project is still justified and acceptable for realization.

A set of criteria used in the investment project evaluation comprise of: Net Present Value (NPV), Internal Rate of Return (IRR), Pay-Back Period (t), Benefit-Cost Ratio (B/C) etc. The input values on the basis of which it is possible to calculate specific individual criteria are: income, costs, value of investment, discount rate, interest rate, etc. (Figure 1).



Figure 1 Calculation of individual criteria using input and output values

Analysis of cash flow was done under assumption of Public Private Partnership (PPP) option of financing of underground garage construction with equal number of underground and over-ground parking spaces (approximately 25 m<sup>2</sup> surface). Taking into account the fact that construction of multiple underground floors significantly increases the construction costs, analysis was based on construction of only one underground floor.

The analysis further was based in case a private partner finances the project from its own sources and with credit funds from commercial banks in 30:70 per cent ratios. The credit has been calculated for 10 years including two years of grace period with accrual of interest on the principal part. The interest rate was 6.369%, while the calculation included credit application fees of 1.5%. The contractual period was 20 years.

The building and maintenance prices are recent ones in Bosnia and Herzegovina and presented in the following Tables 1 and 2 in EUR/parking space (PS). Four scenarios related to capacity and garage surface have been also analysed (Table 3).

**Table 1** Investment costs

No.	Costs	Value (EUR/PS)
1.	Design and review of technical documentation	348
2.	Licences (electric, water, fallout shelter, etc.)	1,495
3.	Building	10,737
4.	Building supervision	138
5.	Compensation for Building Rights	949
<b>TOTAL</b>		<b>13,666</b>

**Table 2** Operating costs

No.	Costs	Value (EUR/PS)
1.	Salaries	205.00
2.	Utility services costs	46.00
3.	Maintenance costs	31.00
<b>TOTAL</b>		<b>282.00</b>

**Table 3** Analysed scenarios

Scenario	Number of parking spaces (underground + over-ground)	Footprint [m <sup>2</sup> ]
Garage 1	50+50=100 PS	1,250
Garage 2	100+100=200 PS	2,500
Garage 3	150+150=300 PS	3,750
Garage 4	200+200=400 PS	5,000

The sensitivity analysis is particularly useful in determining areas where risk is difficult to identify. The basic idea behind the analysis is keep all variables fixed in the Discounted Cash Flow Model except one and then to test the sensitivity of the Net Present Value (NPV) or the Internal Return Rate (IRR) against changes of tested value. Basic settings in analysis were the following:

- Occupancy = 70%;
- Parking price for residential customers = EUR 35 per month;
- Parking price for other customers = EUR 0.50;
- Share of residential customers = 50%;
- Discount rate = 12%.

The criteria used to determine critical parameters were the following:

- Value is deemed critical if the change thereof for 1% resulted with change of over 5% of the Financial (FNPV) or the Economic Net Present Value (ENPV).
- Value is deemed of critical importance if the change thereof for 1% resulted with change of over 1% of the Financial (FIRR) or the Economic Internal Rate of Return (EIRR).

Sensitivity analysis was applied to following parameters:

- 1) Demand (occupancy),
- 2) Parking price,
- 3) Share of residential customers,
- 4) Building costs,
- 5) Interest rate, and
- 6) Discount rate.

The results of the sensitive analysis are given in Table 4.

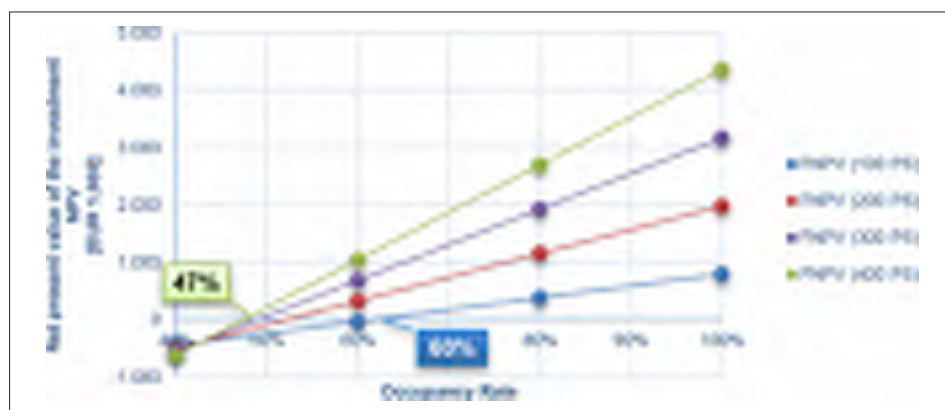
**Table 4** Sensitivity analysis

No.	Costs	Value of FNPV change [%]	Value of FIRR change [%]
1.	Demand (occupancy)	3.20	1.34
2.	Parking price	3.20	1.36
3.	Share of residential customers	2.84	1.21
4.	Investment costs	2.11	1.26
5.	Interest rate	0.33	0.18
6.	Discount rate	2.16	0.014

It is visible in the above table that parameters: demand, parking price, share of residential customers and building costs make critical ones based on Financial Internal Rate of Return (FIRR) criteria as their change for 1% resulted with FIRR change for more than 1%. Hereinafter each of these criteria shall be discussed individually and analysed their impact to project feasibility, i.e. Net Present Value of the investment over 20 year period for defined scenarios (Table 3).

### 2.1 Impact of demand (occupancy) of garage

It is desirable that occupancy of parking is the greatest possible. However, due to daily even weekly nonlinearity, an average occupancy can vary in quite big intervals. The paper examined the impact of occupancy to FNPV when it varies from 40 to 100% while all other values remain fixed. The following Figure 2 has presented comparative chart for all four scenarios.



**Figure 2** Relation between Occupancy Rate and NPV (source: Author)

It can be seen in the above graph that the smallest garage of total 100 PS (50 underground + 50 over-ground) has a limiting occupancy value of min 47%. That means that below this value garage of this size is no longer financially cost effective in the given exploitation period. As size and capacity of the garage increase so does the limiting occupancy value. In case of Garage 4 with total 400 PS (200 underground + 200 over-ground) this limit moves to min 60%. Hence, it can be generally concluded that with increase of the garage capacity grows the per cent of needed occupancy so as to ensure its financial cost effectiveness.

## 2.2 Impact of parking price

The analysis of parking prices encompasses prices ranging from 0.3 to 0.6 EUR/h. The following Figure 3 contains chart showing change of FNPV with change of parking price for all four scenarios. It can be seen that limiting cost effectiveness is lower for garages of greater capacities. That way, for garage of total 400 PS it is 0.34 EUR/h. However, with decrease of garage capacity the limiting cost effectiveness increases and for garage of 100 PS it is 0.45 EUR/h. Hence, the risk of parking price change is far greater in case of smaller capacities garage than the bigger ones. That means that in case of bigger garages, with insufficient occupancy, there is space to reduce parking price without risk to have the investment non-cost effective. In case of smaller garages this value is pretty fixed and leaves no particular space for greater parking price reduction.

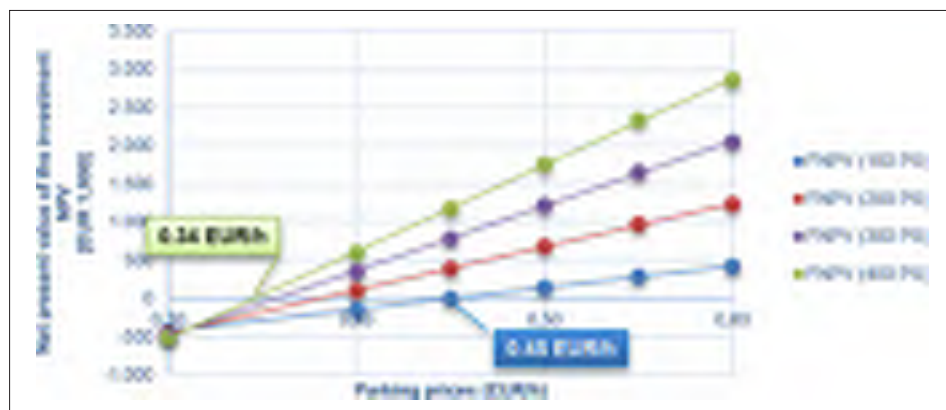


Figure 3 Relation between parking price and NPV (source: Author)

## 2.3 Impact of share of residential customers

Since this percentage is defined by the parking policy, the sensitivity analysis has been applied for change of per cent share of residential customers from 0 to 100%. The following Figure 4 presents all four scenarios.

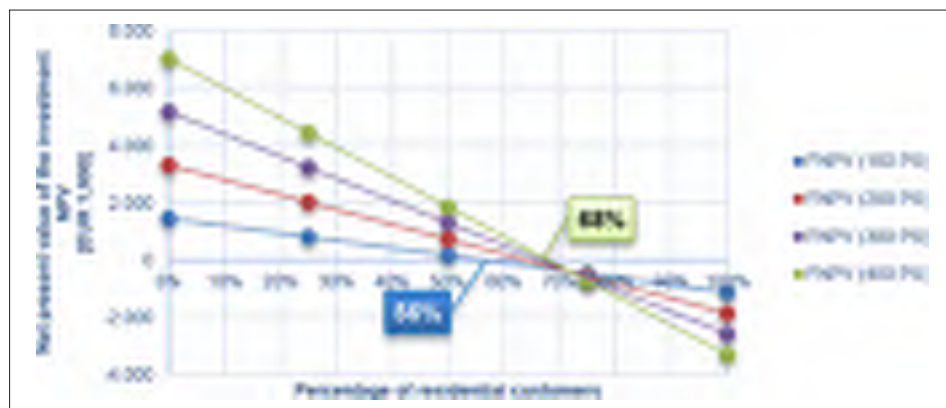


Figure 4 Relation between residential customers and NPV (source: Author)



For very small underground garages the percentage of residential customers would be maximum 56%, constituting the limit of financial cost effectiveness. It is, however, visible that this limit also increase with increase of the garage capacity and for Scenario 4 the point of cost effectiveness is at 68%. In theory, the graph indicates that this value cannot be above 72% for some maximum garage capacity.

## 2.4 Impact of building costs

The sensitivity analysis showed that building cost also present one of the critical parameters. In the Figure 5 it can be seen that with increase of the parking space capacity the FNPV declines more rapidly and building price representing limiting cost effectiveness value for the smallest garage about 485 EUR/m<sup>2</sup>, while in case of bigger garage this value is about 610 EUR/m<sup>2</sup>.

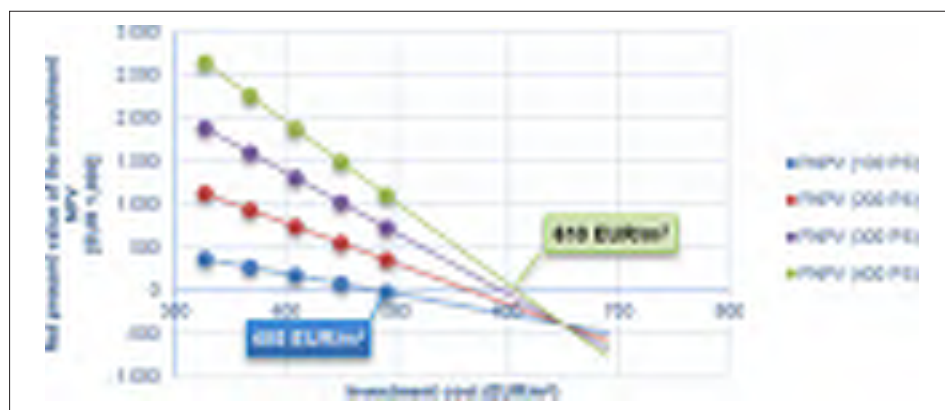


Figure 5 Relation between investment cost and NPV (source: Author)

## 3 Conclusion

In this paper it has been performed the sensitivity analysis of impact parameters to financial cost effectiveness of the project of construction and long-term use (20 years) of underground garage. The analysis has been carried out for four scenarios. Namely, garages of different capacities with one underground floor and one over-ground parking surface have been compared. The sensitivity analysis showed that the critical parameters are:

- 1) Demand (occupancy) of the parking space,
- 2) Parking price,
- 3) Share of residential customers, and
- 4) Building costs.

For each of the listed parameters, sensitivity test has been done, while all four scenarios were shown in parallel. Parameters of demand and parking price have ascending character, i.e. as they increase so does the Financial Net Present Value (FNPV). Two remaining parameters relating to per cent share of residential customers and building costs have descending character. As they increase the FNPV of the investment decline. From afore analysis and comparison the limiting values of these parameters where FNPV=0 have been derived. The following Table 5 contains comparison results for garages with the smallest and the biggest capacities.

**Table 5** Comparative results

No.	Costs	FNPV=0	
		Garage 1 (50 + 50 PS)	Garage 4 (200 + 200 PS)
1.	Demand (occupancy)	min 60 [%]	min 47 [%]
2.	Parking price	min 0,45 [EUR/h]	min 0,34 [EUR/h]
3.	Share of residential customers	max 56 [%]	max 68 [%]
4.	Investment cost	max 485 [EUR/m <sup>2</sup> ]	max 610 [EUR/m <sup>2</sup> ]

Hence, the occupancy of parking space for garages of total 100 parking spaces should not be less than 60%. For garages four times bigger the minimum occupancy is about 47%.

Derives values can be useful in preliminary analysis in case of investment decision for construction of underground garage. Still, assumptions based on which the analysis has been carried out including recent prices in Bosnia and Herzegovina should be taken into account. By applying the sensitivity analysis, information can be gathered on effects of input parameters onto tested criteria for estimation of investment project aimed at investment decision making. The sensitivity analysis can also enable decision maker to adequately overview the problems.

## References

- [1] Benković, J.: Planiranje investicijskih projekata, Zagreb, Ekonomski institut, 1993.
- [2] Maletin, M., et al: Tehnička upustva za projektovanje parkirališta (PGS-P/08), Beograd, 2010.
- [3] Brčić, D., Šoštarić, M.: Parkiranje i garaže, Sveučilište u Zagrebu, Fakultet prometnih znanosti, Zagreb, 2012.
- [4] Tomić, M.: Parkiranje i parkirališta, Saobraćajni fakultet Univerziteta u Beogradu, Beograd, 1995.
- [5] Guide to Cost-benefit Analysis of Investment Projects, Economic appraisal tool for Cohesion Policy 2014-2020, Publications Office of the European Union, 2014.
- [6] Centralna banka Bosne i Hercegovine, Glavni ekonomski indikatori, [http://statistics.cbbh.ba:4444/Panorama/novaview/SimpleLogin\\_bs.aspx](http://statistics.cbbh.ba:4444/Panorama/novaview/SimpleLogin_bs.aspx) (21.06.2015.)





## HOW TO EFFECTIVELY IMPLEMENT MOBILITY MANAGEMENT FOR COMPANIES – EXPERIENCES AND EXAMPLES FROM 5 YEARS OF “SÜDHESSEN EFFIZIENT MOBIL”

André Bruns

*Hochschule RheinMain University of Applied Sciences Wiesbaden Rüsselsheim, Germany*

### Abstract

Mobility Management (MM) in general but especially MM for companies or generally employers both private and public (MMfE) has been successfully established as a means of influencing travel demand towards more sustainability throughout Europe during the past 10 years. It has proven its effectiveness in a variety of forms and contexts from large scale implementations in the course of large infrastructure projects to small scale measures for single employers. Technically MM for companies is a complementary tool for traffic planning adding a demand oriented element to strategies which usually focus on organizing transportation systems. Thus MM for companies “strengthens the lever” of the public hand and adds significantly to the success of traffic planning by making employers strong partners of transport planning helping to meet the goals of planning schemes (e.g. accessibility, reducing nuisances of motorized traffic). It does so by making use of existing organisational structures in companies to implement integrated mobility concepts (e.g. comprising of special public transport fares (job-ticket), promotion of walking and cycling, parking management).

Starting point of the paper is the question of how the potential of MM for companies may be realized in a long term perspective and when no legal obligation for employers exists to start MM activities. The paper presents critical success factors, drawing on 5 years of experience with the “südhessen effizient mobil” program in the Frankfurt region and other activities throughout Germany. It will be shown that besides guidelines, consulting and (little) funding money it is crucial to embed private MM activities of employers into a public framework consisting of stakeholder networks, standards and quality control. This is done by presenting examples of MM activities of employers in the Frankfurt region.

*Keywords: Mobility Management, Sustainable Transport, Traffic Planning*

## 1 Background of Mobility Management for enterprises / employers – a brief outline

### 1.1 Mobility Management – What is it all about?

The concept of Mobility Management (MM) which is known nowadays as a means of influencing travel demand towards more sustainability has seen a long development since the early beginnings. It was in the Netherlands where in the mid 80ies of the last century the American concept of Transport Demand Management was transferred to Europe [1]. From 1990 on Mobility Management started spreading across central Europe, a “common concept of mobility management” being developed [2]. At the same time the European Platform on Mobility Management (EPOMM) was founded providing an institutional framework for the further development of MM and, equally important, a widely accepted definition of MM:

*“Mobility management is a concept for promoting sustainable transport and dealing with the question of car use by modifying the habits and behaviour of travellers. The core of this mobility management is formed by “soft” policy measures such as information and communication, organisation of services and the coordination of activities of the various partners”. [1]*

It has to be stated though that the definition of MM is differing throughout Europe as each country has introduced MM with different focal points leading to the emphasis of different aspects of MM [1]. Therefore it appears necessary to describe some key constitutional aspects forming MM:

- Focus of MM is on travel demand resp. mobility needs of individuals or target groups.
- MM-concepts are characterized by comprehensive sets of measures addressing all means of transportation and their combinations.
- The focus is on soft policy measures as stated in the definition above but the transition to ordinary travel supply measures is smooth and thus MM-concepts very often also comprise hard measures from the classic traffic planning and engineering world such as building bicycle paths, the enhancement of public transport supply or parking management policies.
- MM is based on both vertical and horizontal policy integration as well as the cooperation of numerous public and private stakeholders.
- MM is, even more than planning, a continuous (management) process in which especially evaluation is essential.

Today MM in Europa has reached a certain degree of maturity: MM is inherent part of EU policies [3] and subsequent EU-funding schemes. Almost every European country is member of the ECOMM [1], has in turn established its own national structures and implemented MM as an own policy area either within traffic planning and engineering or in the context of climate protection activities. It was also in the latter context where MM recently has gained even broad international attention when having been identified as the tool at hand to cope with the problems of climate change mitigation within the traffic sector [4].

However, most important is the fact, that MM has proven its effectiveness throughout numerous carefully evaluated projects in various different contexts and at different scales. The range of MM successful applications starts with rather small and local projects, e.g. for a single employer or the implementation of MM in the form of mobility information for new citizens, e.g. in Munich [5]. And it ends on the large scale as a tool which effectively helps to cope with capacity restraints during major infrastructure projects, e.g. the A9 project in the Netherlands [6].

## **1.2 Mobility Management for enterprises / employers (MMfE)**

As described before an important characteristic of MM is that it focusses on the mobility needs of different target groups like children, students, employees, new citizens, tourists, senior citizens etc., thus different areas of MM activity have been established. One of the most prominent and well developed branches of MM is MM for enterprises or employers in general (MMfE). Lacking a common definition MMfE may be described as “a continuous management process in which an enterprise/employer systematically analyses all kinds of corporate mobility or travel demand, sets specific goals towards enhancing the efficiency of the corporate mobility production, defines and implements a set of corresponding measures and evaluates their effects”.

MMfE usually focusses on the following parts of corporate mobility: 1. Home-to-work-trips by employees (work travel). 2. Trips of employees in the course of their work (business travel) which includes the topic of corporate vehicle fleets. 3. Trips of customers or guests (customer travel). In contrast goods traffic and especially logistics are usually not seen as parts of MMfE when they are also part of the core business model of an employer and therefore subject to

own management processes. However, certain aspects of goods travel and logistics may be incorporated in MMfE plans when these processes generate a significant amount of traffic at a certain location. As stated before, the overall, so to speak generic objective of MMfE is to increase the efficiency of corporate mobility. Looking on it from different perspectives several more specific aims of MMfE can be identified:

- From an employer’s perspective MMfE may aim at: a) efficiently allocating financial resources, e.g. by reducing costs of vehicle fleets or business trips; b) enhancing site accessibility and reducing traffic congestion, e.g. by reducing the share of motorized individual traffic; c) support recruiting of qualified labour by fostering a positive image as an employer, e.g. by introducing job tickets for public transport; d) reducing mobility induced CO2 emissions as part of corporate sustainability strategies.
- From the perspective of the public hand MMfE aims at: a) promoting sustainable transport and thus contributing e.g. to climate protection strategies; b) enhancing accessibility and traffic flow; c) mitigating traffic related problems e.g. traffic congestion, emission of pollutants and noise.

The latter benefits for the general public are the main reason why MMfE has become a major focus of public MM policies during the last years. A comprehensive study for the Frankfurt RheinMain region shows potential benefits of a systematic implementation of MMfE. The study was based on regional wide data on existing employers and available evaluation data of MMfE projects as well as on accessibility modelling by means of the regional traffic model. The study showed that when implementing MMfE regional wide one of five work travel related car trips may be shifted to other transport modes and vehicle kilometres may be reduced substantially by 25% [7]. Considering the effects on both CO2 emissions (reduction of about 150.000 tons per year [7]) as well as traffic flow in the major road network resulting from that, the importance of MMfE as a means of transport and climate protection policy is obvious.



Figure 1 Measures of MMfE [9] (translated by the author)

MMfE comprises a broad spectrum of measures; Fig. 1 depicts the major fields of action and examples of measures. According to the description of MM above, corporate MM concepts are both integrated and comprehensive action plans which means that they contain bundles of measures aiming at all transport modes. Since MMfE and generally MM aims at changing travel behaviour and especially routines concerning modal choice, special emphasis lies on measures in the fields of communication and organisation.

## 2 Effectively implementing MM for enterprises / employers

Having its substantial potential benefits in mind, the logical implication seems to be that MMfE is a natural part of up to date transportation policy as it obviously ideally complements the classic supply oriented policy approaches. It so to speak strengthens the lever of transportation policy as it makes use of existing organisational structures within enterprises to influence travel demand by actively stimulating behavioural changes rather than waiting for people using the existing traffic systems in a way traffic engineers want them to. However, although MMfE may incorporate benefits worthwhile even out of an employer's perspective this has not led to an automatic breakthrough of MMfE in practice; obviously some external stimulation is needed to boost the concept. Thus the major question for transport policy makers as well as planners and engineers is what it needs to put this potential into effect? This question will be addressed by in the following chapter by elaborating on the five years of experience from the German "südhessen effizient mobil" program geared to facilitate MMfE.

### 2.1 Essential challenges (from a German perspective)

The first major challenge on the way to an MMfE breakthrough seems to be the motivation of employers to start corresponding management processes. From numerous contacts to enterprises in the Frankfurt RhineMain region the author draws the following conclusions concerning the major underlying reasons:

- The issue of priorities ("nice to have" or "must have"): Corporate mobility is surely regarded as an important issue as it facilitates business processes, but nevertheless it is a servicing function and thus not top focus of decision makers.
- The issue of value for money: Connected to the first question most managers first call for concrete numbers on benefits. Due to lacking evaluation data this question is in most cases hard to answer in a convincing way.
- The issue of how to and know how: Successful MMfE requires coordinated activities of different parts of a business starting with human resources and ending at fleet and real estate management. Quite often not knowing where to start prevents employers from implementing MMfE.
- The issue of limited spheres of influence: Other than in the field of energy efficiency, the success of MMfE does not solely lay in the hands of enterprises. The public hand has to be involved when it comes to measures concerning transport supply and cooperation in this field between administrations and enterprises is in this case not widely established.

But, secondly, hindrances are also existent on the side of the public hand in Germany as no legal obligation exists to conduct MMfE or MM activities in general. Thus the majority of municipalities lack strategic processes aiming at systematically implementing MM which could be an anchor and/or catalyser for private MMfE activities. Connected to the missing obligation is the problem of missing funds as the flexibility of municipal budgets concerning voluntary activities has been substantially reduced due to the German "debt brake" policy.

## 2.2 The approach of südhessen effizient mobil

To overcome these challenges, different funding projects have been implemented in Germany: The first generation of projects concentrated on fostering MMfE by 1<sup>st</sup> developing methods and tools, 2<sup>nd</sup> fund actual MMfE processes, 3<sup>rd</sup> building regional and local networks of stakeholders and 4<sup>th</sup> conducting extensive public relation activities. The most prominent project in this generation was the “effizient mobil” program [10] which funded MMfE processes in 100 enterprises all over Germany. However, despite the initial success of “effizient mobil” it soon became clear that the MMfE processes started to a great extent were not enduring after the funding ended. Process evaluation showed several crucial shortcomings: 1. 100% funding of external consultants did not result in enduring internal processes, 2. the funding period was too short to establish regional and local stakeholder networks to embed the activities of the enterprises, 3. this correlated with a lack of acceptance of MM among municipal politicians. After that first attempt, a second generation of funding schemes have been established explicitly building up on those lessons learned: 1. the “MobilProFit” program explicitly aims at establishing 12 regional focal points where both MMfE processes as well as stakeholder networks are funded [11]. 2. the “südhessen effizient mobil” program is a follow up process of the initial “effizient mobil” and was established 5 years ago in the Frankfurt RhineMain region [9] by regional and local institutions within the public sector (ivm – integrated traffic and mobility management Frankfurt RhineMain region, cities, districts, public transport (PT) authorities as well as the chambers of commerce). In the following the strategic approach as well as the key success factors from “südhessen effizient mobil” (SEM) are presented.

While the operative goal of SEM is quite simple, to foster MMfE processes at as many employers as possible, the strategic goals are more divers and directly connected to the major challenges described above [12]:

- 1) using MMfE as a breakthrough topic for establishing MM in general as a field of action in municipalities, permanently anchoring MM on the local level
- 2) creating and ensure standards concerning the quality of MMfE processes, including precise guidelines and qualification profiles
- 3) fostering the market for MM consultancy
- 4) evaluate and quantify the effects of MMfE
- 5) support the strategic communication between municipalities and enterprises

Above that a main attempt was to create a funding scheme which solely relies on regional (public) budgets in order to be able to offer a long lasting independent support. According to that the program was based on two pillars:

- a) The actual funding scheme, which offers a free of charge 1<sup>st</sup> level consultancy to employers to the point of a corporate MM concept utilising standardised tools (status quo analysis, impact assessment, evaluation etc.) and consultancy from quality controlled experts. Above that the support for the employers was organised in form of a workshop program which stimulates the enduring exchange between participants.
- b) One regional and several local stakeholder networks comprising of municipal administrations, public transport authorities as well as the local chambers of commerce as a leading partner.

The program is moreover flanked by a 2 level audit scheme assessing the quality of the planning process (1<sup>st</sup> level, certificate valid for 3 years) and subsequently the implementation of measures as well as impacts (2<sup>nd</sup> level after 3 years). The SEM program is currently in its 6<sup>th</sup> year of operation and is about to become a permanent institution in the Frankfurt RhineMain region. Up to now over 60 MMfE processes were supported. Currently the emphasis, besides further growth, is on properly evaluating effects and improving model based impact forecasting.



The main strategic approach of the program 1<sup>st</sup> is to get employers started with MMfE by means of (little) external funding effort and expertise for the first phase of the MMfE process and that the internal process afterwards is sustained by internal resources, with only marginal further support by the SEM program. 2<sup>nd</sup> the program especially attempts to interconnect public and private players to realise potential effects within the field of work travel, usually being a limited influence sphere for employers. Many good practice examples have proved this approach to be a key success factor for promoting MMfE:

- The data from the standardised mobility survey can directly be used as a basis for a “Job Ticket” contract with the regional PT authority (RMV), enabling employers to offer an inexpensive access to PT for their workforce on work trips. The chamber of commerce in Darmstadt e.g. combined the Job Ticket with a parking allowance to a so called mobility card (employees pay once for access to PT and parking space which was free of charge before), this led to a drop of the share of daily car drivers within work travel from above 70% to below 40%. [9]
- Close cooperation within the SEM program between a deep-frozen-food producer (Erlebnacher Backwaren) which was not accessible by PT and the local PT authority led to a cooperative solution where the employer restructured his complex shift model to make it fit to the PT authorities needs concerning efficient production of PT supply. [9]
- In an extensive MMfE process by the Technical University of Darmstadt TUD) which implemented a comprehensive MMfE scheme including the issuing of a mobility card similar to the one of the chamber of commerce, a permanent high level coordination process between the TUD and the city of Darmstadt was installed. This allowed for coordinated planning of PT as well as parking management to cope with the massive rise of PT use by almost 50% and a decline of car trips by 35%). [13]

### 3 Conclusions

As shown MM in general has the potential to add substantial effect to traditional mobility and traffic planning by directly addressing travel demand. This especially applies to MMfE as it makes use of existing organisational structures in companies to implement integrated mobility concepts. However the experiences up to now show that MMfE is not a self-runner but needs to be supported. Evaluations of past funding schemes in Germany revealed though that funding money may not be the decisive part in a long lasting strategy to support MMfE. In fact the experiences from the Frankfurt RhineMain region lead to the conclusion that besides guidelines, consulting and (little) funding money it is crucial to embed private MM activities of employers into a public framework consisting of stakeholder networks, standards and quality control. Besides that financial resilience (not relying on temporary external funding) as well as intensive and long lasting efforts to convince employers as well as local politicians by means of carefully evaluated good practices are key success factors.

### References

- [1] EPOMM – European Platform on Mobility Management: Mobility Management: The smart way to sustainable mobility in European countries, regions and cities, Brussels, 2013. Available online: [http://epomm.eu/docs/file/epomm\\_book\\_2013\\_web.pdf](http://epomm.eu/docs/file/epomm_book_2013_web.pdf), 30.03.2016.
- [2] ILS, ISB: Mobilitätsmanagement Handbuch. Einführung in Ziele, Instrumente und Umsetzung von Mobilitätsmanagement. Institut für Landes- und Stadtentwicklungsforschung des Landes Nordrhein-Westfalen, Institut für Stadtbauwesen und Stadtverkehr RWTH Aachen, Dortmund/Aachen, 2000.
- [3] European Commission: WHITE PAPER Roadmap to a Single European Transport Area – Towards a competitive and resource efficient transport system, Brussels, 2011, available online: <http://eur-lex.europa.eu>, 30.03.2016.
- [4] Creutzig, F. et al: Transport: A roadblock to climate change mitigation? Science 20 Nov 2015, pp. 911-912, doi: <http://dx.doi.org/10.1126/science.aac8033>.

- [5] Bamberg, S., Farrokhkhiavi, R.: Breaking habitualised car use with a 'soft-policy' measure? Effects of a dialogue marketing campaign on new citizens' daily mobility. European Transport Conference 2009 Proceedings, available online: <http://abstracts.aetransport.org>, 30.03.2016.
- [6] de Munck, G.B.G.: Pauwels, H.: Managing Mobility During Road Works. European Transport Conference 2009 Proceedings, available online: <http://abstracts.aetransport.org>, 30.03.2016.
- [7] Mühlhans, H., Heller, S., Fricke, T., Bohnet, M., Stiewe, M.: Potentials and impacts of regional strategies for Mobility Management, 16<sup>th</sup> ECOMM 2012 in Frankfurt, available online: [http://epomm.eu/ecomm2012/A5\\_PK\\_MM/A5\\_3\\_Bohnet,%20Fricke,%20Muehlhans,%20Stiewe\\_Regional%20strategies%20for%20MM.pdf](http://epomm.eu/ecomm2012/A5_PK_MM/A5_3_Bohnet,%20Fricke,%20Muehlhans,%20Stiewe_Regional%20strategies%20for%20MM.pdf), 30.03.2016.
- [8] Deming, W.E.: Out of the Crisis. Massachusetts Institute of Technology, Cambridge 1982.
- [9] Netzwerk südhessen effizient mobil: Auf Erfolgskurs. Fünf Jahre Betriebliches Mobilitätsmanagement "südhessen effizient mobil", Darmstadt, 2016, available online: [http://www.ivm-rheinmain.de/wp-content/uploads/2016/02/Broschuere\\_5j\\_Mobilitaetsmanagement\\_online.pdf](http://www.ivm-rheinmain.de/wp-content/uploads/2016/02/Broschuere_5j_Mobilitaetsmanagement_online.pdf), 30.03.2016.
- [10] Deutsche Energie-Agentur GmbH (dena): effizient mobil. Das Aktionsprogramm für Mobilitätsmanagement. Programmdokumentation 2008-2010. Berlin, 2010, available online: [http://www.effizient-mobil.de/fileadmin/user\\_upload/effizient\\_mobil/Download/MOB\\_BR\\_Programmdoku10\\_19RZ\\_Einzelseiten.pdf](http://www.effizient-mobil.de/fileadmin/user_upload/effizient_mobil/Download/MOB_BR_Programmdoku10_19RZ_Einzelseiten.pdf), 30.03.2016.
- [11] Mobil.Pro.Fit project homepage, [www.mobilprofit.de](http://www.mobilprofit.de), 30.03.2016.
- [12] Bruns, A.: Verankerung von betrieblichem Mobilitätsmanagement in Politik und Verwaltung. 4. DECOMM, Stuttgart, 2015, available online: <http://www.depomm.de/download.b1-suedhessen-effizient-mobil-als-beispielprojekt-zur-verankerung-von-betrieblichen-mobilitaetsmanagement-in-politik-und-verwaltung.16.htm>, 30.03.2016
- [13] Stascheck, A.: Integriertes Mobilitätsmanagement an der TU Darmstadt. 4. DECOMM, Stuttgart, 2015, available online: <http://www.depomm.de/download.a2-integriertes-mobilitaetsmanagement-an-der-tu-darmstadt.11.htm>, 30.03.2016.





## DEVELOPING DECISION SUPPORT TOOLS FOR RAIL INFRASTRUCTURE MANAGERS

Irina Stipanovic Oslakovic<sup>1</sup>, Kenneth Gavin<sup>2</sup>, Meho Saša Kovačević<sup>3</sup>

<sup>1</sup> University of Twente, Faculty of Engineering Technology, The Netherlands

<sup>2</sup> Gavin and Doherty Geo-Solutions Ltd., Ireland

<sup>3</sup> University of Zagreb, Faculty of Civil Engineering, Croatia

### Abstract

European rail infrastructure managers (IMs) are managing ageing rail infrastructure with 95% of the network having been built before 1914. EU transport policy provides the challenge to IMs to increase the productivity of existing rail networks, prioritise renewal and optimise new sections to reduce bottlenecks, increase productivity and achieve a switch from freight transport by road to rail. This needs to be achieved at a time when budgets are restricted whilst improving customer satisfaction and dealing with challenges from natural hazards and extreme weather events which are affecting all of Europe.

In order to deal effectively with this grand challenge, Europe will need to develop methods to manage its rail infrastructure across the single European railway area. Whilst decision support tools are widely applied across, these systems tend to concentrate on only one asset and inherently suffer from the several limitations.

In this paper the European H2020 project Destination Rail that focuses on the development of decision support tool for rail infrastructure managers is presented. Within DESTination RAIL the aim is to provide solutions for a number of problems faced by EU infrastructure managers, such as assessment of existing assets, use of existing databases controlled by an information management system, risk assessment, maintenance and construction techniques for treating rail infrastructure including tracks, earthworks and structures, whole life cycle assessment and impact on the traffic flow. Each of these separate streams are incorporated into the Decision Support Tool which will be the primary exploitable deliverable from the project, and demonstrated on several railway projects across the European network.

*Keywords: decision support tool, maintenance planning, European project, DESTination RAIL*

### 1 Introduction

European rail infrastructure managers (IMs) are managing ageing rail infrastructure with 95% of the network having been built before 1914 [1]. EU transport policy provides the challenge to IMs to increase the productivity of existing rail networks, prioritise renewal and optimise new sections to reduce bottlenecks, increase productivity and achieve a switch from freight transport by road to rail. This needs to be achieved at a time when budgets are restricted whilst improving customer satisfaction and dealing with challenges from natural hazards and extreme weather events which are affecting all of Europe. A number of high profile failures of rail infrastructure have occurred in recent years, with the incidence appearing to increase in response to climate challenges and aging networks amongst other factors, see Figure 1.



**Figure 1** Recent railway failures: a) Rockfall on Zagreb-Split railway track in Croatia in 2014 [2]; b) Derailment of a Swiss train caused by a rainfall induced landslide, in 2014 near the Swiss Ski resort of St. Moritz [3]

In order to deal effectively with this grand challenge, Europe will need to develop methods to manage its rail infrastructure across the single European railway area. As well as being a significant asset, proper management of the rail infrastructure network is an essential mean in achieving key policies, such as developing the East-West connections, reducing disparity in infrastructure quality between member states, reducing fragmentation along the TEN-T network, reducing greenhouse gas emissions and increasing movement of goods and people. Establishment of a Single European Railway Area (SERA) is seen in the 2011 Transport White Paper as being critical to ensuring long-term competitiveness, dealing with growth, fuel security and decarbonisation in the EU. The European Rail Industry employs 800,000 people and generates a turnover of €73bn [4]. Public investment in Rail is significant, amounting in 2009 to a spending of €26bn on infrastructure. [5] Despite this serious investment growth in passenger numbers is low and the gains in term of modal share of rail remains moderate. Whilst part of this is due to the historical organization of the rail sector across Europe the significant spend of overall budgets on infrastructure maintenance, renewal and development gives a clear indication of the importance of this aspect.

The three-year Horizon 2020 project DESTination Rail, is funded by the European Commission under grant agreement No 636285, through the Innovation and Networks Executive Agency (INEA) under the call MG-2.1-2014, I2I Intelligent Infrastructure. The project started on May 1<sup>st</sup> 2015. The overall concept and main aims of the project are explained in the following chapters.

## 2 Overall concept of DESTination RAIL project

The aim of DESTination RAIL is to provide solutions for a number of problems faced by EU infrastructure managers. Novel techniques for identifying, analysing and remediating critical rail infrastructure will be developed. These solutions will be implemented using a decision support tool, which allows rail infrastructure managers to make rational investment choices, based on reliable data, see Figure 2. Main aims of the project are:

- 1) To provide solutions for common infrastructure problems encountered in diverse regions across Europe e.g. bridge scour, slope instability, ballast degradation, rock-falls and failure of switches and crossings.
- 2) The project will develop management tools based on scientific principles for risk assessment using structural health monitoring (SHM) and other vital data stored in an Information Management System.
- 3) A decision support tool will be developed to allow decisions on investments for maintenance and new works to be made by Infrastructure Managers (IM's) on the basis of scientific principles.



Figure 2 Integration of all components into Decision Support Tool (DST)



Figure 3 Project structure [6]

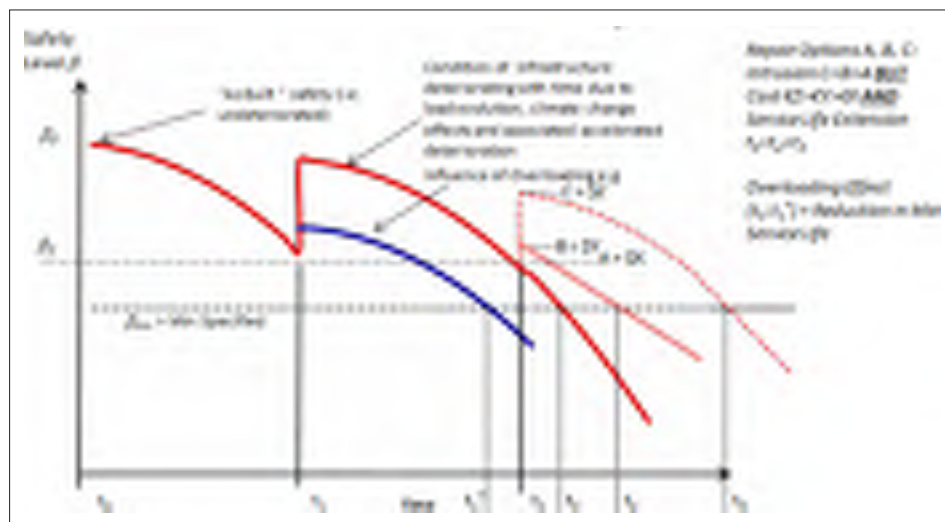
The challenges facing Europe’s Infrastructure Managers can be divided into four areas that are addressed directly in the DESTination RAIL project, see Figure 3, through a holistic management tool based on the FACT (Find, Analyse, Classify, Treat) principle:

**Find:** Identifying vulnerable critical assets before failure, knowing how assets are actually performing and the stability of the geological-engineering condition surrounding those assets by improved monitoring techniques, see Figure 4.



Figure 4 Drone with high resolution camera to detect high risk areas.

**Analyse:** Having appropriate tools to process this condition monitoring information and data to accurately assess the condition of the asset and the effect of different maintenance on it, see Figure 5. Advanced probabilistic models will be developed and fed by performance statistics which will be used to determine the level of safety of individual assets.



**Figure 5** Probabilistic life cycle optimization model integrating condition monitoring information

**Classify:** Understanding how risks and individual components relate to the overall system, and how changes in the system affect individual components. The performance models will allow a step-change in risk assessment, moving from the current subjective (qualitative) basis to become fundamentally based on quantifiable data. A decision support tool will take risk ratings and assess the impact on the traffic flow and whole life cycle costs of the network.

**Treat:** Conducting maintenance and repairs so the whole network is safe and reliable for users (people and freight) within the restrictions of limited maintenance budgets and the need for increasing sustainability. Novel and innovative maintenance and construction techniques for treating rail infrastructure including tracks, earthworks and structures will be developed and assessed by whole life cycle assessment and impact on the traffic flow.

### 3 Holistic Management Tool

#### 3.1 Current situation

At present Infrastructure Managers make safety critical investment decisions based on poor data and an over-reliance on visual assessment. As a consequence their estimates of risk are therefore highly questionable and large-scale failures are happening with increasingly regularity. As the European rail Infrastructure network ages, investment becomes more challenging. As a result reliability and safety are reduced, users perception of these is negative and the policy move to increased use of rail transport is unsuccessful. Whilst decision support tools are widely applied across a range of domains, JRC [7] notes that they tend to work either at a sectoral level (e.g. transportation, or energy etc.) or at an asset level. The first approach is typically undertaken to drive policy, e.g. at a National or European level and thus tends to simplify the consideration of individual assets. In contrast methodologies for assessing certain assets are well defined. In the rail transport sector most IM's are implementing decision support tools on an asset-by-asset basis, for example steep slopes [8] and level crossings [9].

A management system RAILER® EMS, has been developed by the U.S. Army Engineer (ERDC-CERL) as a decision support toolbox for managing defects on tracks. However, these systems tend to concentrate on only one asset (as with the RAILER system) and inherently suffer from the following limitations, which will be addressed in the Destination Rail Project:

- 1) The data used to perform the risk assessment is mostly inadequate. An over-reliance on visual assessment and guestimates for condition monitoring are the norm rather than the exception.
- 2) They do not consider the effects of traffic flow.
- 3) They suffer from a lack of a system wide database of asset condition and performance.
- 4) They do not account for whole life cycle assessment in a probabilistic manner.

### 3.2 Information Management System

DESTination RAIL has already developed an information management system (IMS) based on the literature study and identified needs through expert interviews [10]. The IMS is designed to hold all the data relating to an individual asset and the network as presented in Figure 6.

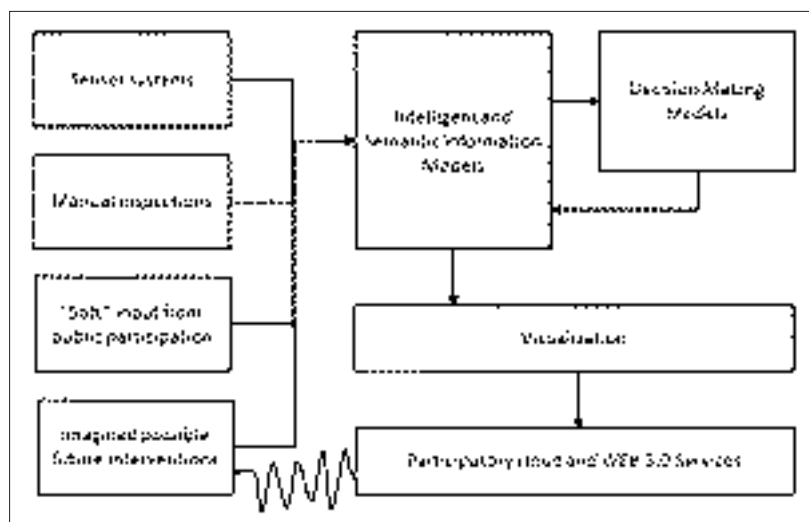


Figure 6 IMS scheme

Objects in the information model can describe physical entities of the railway infrastructure, such as track or bridge, or conceptual entities related to railway asset management tasks, such as, cause of failure. In addition to representing the physical objects, the information model also represents important attributes of these objects and relationships between the objects. To keep the IMS simple, we have omitted operational details, such as train schedules or railway stocks. IMS is planned as a dynamic model which will adapt changing requirements along its implementation. The IMS will allow to:

- manage the relationships between information items from a diverse range of sources (sensor input streams, manual inspections, risk assessment input parameters, risk assessment outcomes, key performance indicators, etc.)
- keep track of changes within information items throughout the lifecycle of the infrastructure object, and
- aggregate and disaggregate information across different spatial scales (sub-object, complete object, object network) and semantic richness (raw sensor-based data stream to semantically rich information descriptions), and levels of detail.



The development of the information model is based on the knowledge from computer science (system architecture, database architecture, object oriented modelling) and from the domain of infrastructure performance and management.

### 3.3 Risk Assessment and Risk Ranking

Based on the probability of occurrence of the events (e.g. floodwaters deeper than x meters) to which the infrastructure objects will be subjected and the probability of the infrastructure objects providing different levels of service following an event (e.g. due to a flood the road/rail is closed for two days but then reopened without need to execute an intervention, or is closed for two months until it can be rebuilt), risk assessment will be performed. It is particularly challenging to develop such a methodology as infrastructure-related risk due to natural hazards depends on the functioning of all objects in the network simultaneously and the maintenance strategies being followed to allow for an estimate of the amount of downtime expected. It will make use of standard tools, such as event tree and fault tree analysis, as well as the state-of-the-art in network connectivity analysis.

The methodology will be established keeping in mind that the assessment of risk evolves over time and that data collected at different times and in different ways does not always have the same value, especially in non-stationary systems. This means that it will be devised to update past information based on new information, for example to take into consideration the object's exposure to real events.

The methodology developed within this task will provide infrastructure managers with a way to identify the risks related to a single object that is working as part of a network to provide a specific level of service. The risk assessment that results from this methodology will form the basis for the risk ranking, and will therefore help infrastructure managers to allocate their limited resources better. This means instead of focusing just on risk, it will take into consideration the availability of resources to reduce risk, the ability to accept or tolerate risks, the effectiveness or availability of interventions to reduce risk and the residual risks following an intervention. The methodology will allow different interventions to be compared, taking into consideration their relative costs (both direct and indirect).

In addition to this the ranking methodology will also take into consideration options to execute risk reducing interventions on multiple objects simultaneously for lower costs than if the interventions were executed individually.

The methodology will be tested on object and network level case studies, to update a model which considers the deterioration of the infrastructure over time and allows for consideration different hazard scenarios. It will be possible to use the prototype tool to illustrate the impact of different intervention strategies on the long-term risk rating of the objects in the network.

### 3.4 Decision Support Tool

The Decision Support Tool (DST) which is being developed in the project will help infrastructure managers in decision making process in the context of dealing with a number of previously identified and ranked risks. The DST will integrate the outputs from inspection and monitoring, probabilistic reliability modelling, whole life cycle analysis (WLCA) and traffic flow model, and use them under specific process workflows and modules.

The tool will be tested on several scenarios for selected railway sections, meaning different input values for different variables will be used in order to test the defined interrelatedness between different risk factors and the meaningfulness of the outcome of the tool.

The DST should form the basis for the development of 'pre-standard' or benchmark guidelines which can be used by infrastructure managers and stakeholders to support robust development measures which ultimately mitigate multiple risks that are associated with aging railway networks, increased traffic and climate change impacts, along with decreasing ma-

aintenance budgets. Beside by integration of WLCA the objective is to develop maintenance and rehabilitation strategies which will minimise their socio-economic and environmental impacts. DST will use intuitive Graphical User Interface features for executing contextual risk management workflows for strategic decision-support, that take on board EU regulations and ISO standards.

## 4 Conclusion

The DESTination RAIL consortium brings together experts from across Europe in the areas of condition monitoring, asset performance, risk assessment and life cycle analysis. The consortium has designers and researchers at the cutting edge of analysing individual assets, based on structural engineering, geotechnics and traffic modelling. A number of infrastructure managers will feed-in industry know-how, provide pilot and demonstration sites and leading infrastructure management researchers will develop the key output, the Decision Support Tool in conjunction with SME's and IM's. At the moment of finalizing this paper the conceptual framework of the decision support tool, risk assessment methods and life cycle cost models are under development as a part of the project.

## Acknowledgement

We gratefully acknowledge the support from the EU H2020 programme for DESTination Rail, funded by the European Commission under grant agreement No 636285, through the Innovation and Networks Executive Agency (INEA) under the call MG-2.1-2014, I2I Intelligent Infrastructure. Framework Programme.

## References

- [1] European Railway Agency, Intermediate report on development of railway safety in the European Union, 2013.
- [2] [www.jutarnji.hr](http://www.jutarnji.hr)
- [3] [www.bbc.com](http://www.bbc.com)
- [4] European Commission: The Fourth Railway Package – Completing the Single European Railway Area to Foster European Competitiveness and Growth, 2013.
- [5] European Commission – DG for Mobility and Transport, The Performing Rail Infrastructure Manager, 2013.
- [6] [www.destinationrail.eu](http://www.destinationrail.eu)
- [7] JRC-IPSC, Risk assessment methodologies for Critical Infrastructure Protection. Part I: A state of the art, 2012, [http://ec.europa.eu/home-affairs/doc\\_centre/terrorism/docs/RA-ver2.pdf](http://ec.europa.eu/home-affairs/doc_centre/terrorism/docs/RA-ver2.pdf)
- [8] GDG, Decision Support Tool for slope management, Report for Irish Rail, 2014.
- [9] RODIS, A decision support tool for managing level crossings, Report for Irish Rail, 2012.
- [10] Allah Buhksh, Z., Hartmann, T., Stipanovic Oslakovic, I.: Deliverable 3.1 Information Management System Framework, [www.destinationrail.eu](http://www.destinationrail.eu), 2016.





## SOME ISSUES REGARDING THE LEGAL STATUS OF ROADS IN THE REPUBLIC OF CROATIA

Damir Kontrec<sup>1</sup>, Davor Rajčić<sup>2</sup>

<sup>1</sup> Supreme Court of the Republic of Croatia, Croatia

<sup>2</sup> University of Zagreb, Faculty of Civil Engineering, Croatia

### Abstract

The paper will give an overview of some of the issues concerning the legal status of roads, emphasizing the provisions regarding the registration procedure of public and unclassified roads in the land registry. These issues should have been regulated by the legislation but even after its passing some of the issues remain unresolved and cause problems in the implementation.

*Keywords: registration, roads, land registry*

### 1 Introduction

The Croatian Parliament passed at its session held on 8 July 2011 the Roads Act (hereinafter referred to as “RA”) published in the Official Gazette of the Republic of Croatia No. 84/11 [3]. The RA was amended by the Act on Amendments published in the Official Gazette No. 22/13, the Act on Amendments published in the Official Gazette No. 54/13, the Act on Amendments published in the Official Gazette No. 148/13 and the Act on Amendments published in the Official Gazette 92/14. The subject of this paper are the provisions of the RA and the Act on Amendments published in the Official Gazette No. 92/14 (hereinafter “AA RA/14”).

### 2 Public roads

Public roads are public goods in general use owned by the Republic of Croatia, which can be used by everyone in the manner and under the conditions specified in the RA and other acts. According to Vedriš and Klarić, public goods are owned by the Republic of Croatia, and can be in general use (e.g. roads) or in public use (e.g. vehicles) (Građansko pravo 2004: p. 240) [1]. Public roads in the ownership of the Republic Croatia cannot be alienated nor can the proprietary rights of public roads be acquired, except in the cases specified in the RA. According to Vedriš and Klarić, the Roman principle of *numerus clausus* applies to the number of proprietary rights in our legal system, therefore there can only be proprietary rights which are specified as such in a legal act, and which are divided into the proprietary right of one’s own possessions (right of ownership) and proprietary rights of another’s possessions (other proprietary rights), which some authors refer to as sector rights (Građansko pravo 2004: p. 185-186) [1]. Act on Ownership and Other Proprietary Rights [4] acknowledges the following proprietary rights: ownership, easement, lien, encumbrance and building right. Easement right can be established over a public road as well as building right with the purpose of building public utilities, water, energy constructions and electronic communications constructions and other associated facilities, in a manner prescribed by the RA (Act on Ownership and Other Proprietary Rights acknowledges proprietary and personal easements).

A public road becomes a public good in general use upon the legal validity of the use permit, i.e. upon issuing of another act on the basis of which the use of the construction is permitted with respect to the special regulation.

Public road is registered in the land registry books on the basis of a valid use permit as a public good in general use and as an inalienable property of the Republic of Croatia, with the registration of Croatian Motorways Ltd. (Hrvatske ceste d.o.o.) as a legal entity authorised to manage motorways, of Croatian Motorways Ltd. as a legal entity authorised to manage state roads and of county department for roads as a legal entity authorised to manage county and local roads. Real estates and proprietary rights over those estates, as well as other important real estate information, are registered in the land registry books.

Easement and building rights over a public road as well as concession rights are entered in the land registry as required by the legislation governing the Land Registration Act [5].

### **2.1 Termination of the public good in general use status of a public road**

When the need for using a public road or any of its parts as a public road permanently stops, its status of a public good in general use may be terminated, and the property losing its public good in general use status remains in the ownership of the Republic of Croatia.

Proposal for termination of the public good in general use status of a public road or its part is submitted by a legal entity managing the public road to the competent ministry. The resolution to terminate the public good in general use status of a public road or its part as proposed by the competent ministry is made by the Government of the Republic of Croatia or the body authorised by the Government.

The resolution to terminate the public good in general use status of a public road or its part contains a provision referring to deletion of a public road or its part as a public good in general use from land registry books and it is delivered to the legal entity managing the public road together with the allotment analysis to the competent municipal state attorney's office with the purpose of implementing the resolution in the land registry.

### **2.2 Classification of public roads**

Public roads are, depending on their social, transport and commercial value, classified into one of four categories, Article 6 of the RA.

### **2.3 Criteria for classification of public roads**

Public roads are classified according to the criteria specified in the regulation passed by the Government of the Republic of Croatia, Article 7 of the RA.

The resolution to classify public roads, which specifies motorways, state roads, county roads and local roads and their marking, is made by the competent minister and it is published in the Official Gazette of the Republic of Croatia.

Public road which is no longer classified as such, as a rule, becomes an unclassified road.

On the other hand, by classifying an unclassified road as a public road, an unclassified road becomes a public road.

Both described methods of status change require no payment of fees to the former owner, and the existing registry information in cadastre and land registry books will be replaced by new relevant decisions regarding the change of their status. Cadastre is the register of land and objects on and under that land, containing the necessary land plot information.

## 2.4 Registration of public roads in the land registry

Public roads which were built before the date of the RA's entry into force, for which the survey of the current state was conducted and which are recorded in the cadastre, should have been registered in the land registry as a public good in general use, as an inalienable property of the Republic of Croatia, with the registration of the legal entity managing the public road, regardless of the existing registration in the land registry books. Transitional and final provisions, Articles 123-130 of the RA. Registration was conducted ex officio by the land-registry courts based on the decision regarding classification and the application form with the current state analysis.

Public roads built before the date of the RA's entry into force which are not recorded in the cadastre or there is no record of their actual state, are, first of all, recorded in the cadastre based on the resolution regarding classification and geodetic survey analysing the current state, and which the legal entity managing the public road was obliged to obtain. Relevant provisions regarding the registration of public roads which were recorded in the cadastre were applied to the registration procedure in the land registry.

The AA RA/14 (Article 2) made amendments to the resolutions regarding public roads which were not recorded in the cadastre or there was no record of their actual state, so that these public roads, built before the date of the RA's entry into force, would be recorded in the cadastre based on the resolution regarding classification, geodetic survey analysing the current state of the public road and the decision by a competent land-registry court concerning the implementation of application form.

These public roads will be recorded in the land registry as a public good in general use, as an inalienable property of the Republic of Croatia, with the registration of the legal entity managing the public road, regardless of the existing registration in the land registry books.

Properties which were regarded as public roads according to the RA and which were used as public or unclassified roads before 1 January 1997 are a public good in general use and an inalienable property of the Republic of Croatia. Unclassified roads are inalienable property of the local self-government units within whose territory the road is situated.

Furthermore, the RA's transitional provisions regulated the issues regarding the registration of public roads built after the date of its entry into force, so that its implementation is achieved in accordance with general provisions which regulate the registration of ownership rights.

Proposal for the registration of ownership rights of the roads at issue is made to the competent land-registry court by the competent state attorney's office.

The competent land-registry court issues a decision regarding the registration process, which is in accordance with the procedure specified by the act regulating the land registry.

## 3 Unclassified roads

Article 98 of the RA stipulates that unclassified roads are those which are used for motor traffic and which can be freely used by anyone in a manner and under conditions specified by the RA and other regulations, and which are not classified as public roads within the meaning of the RA. The RA particularly sets apart:

- roads in city areas with population over 35,000 and city areas which are county seats, which were classified as public roads by the decision concerning the classification of public roads into state roads, county roads and local roads (Official Gazette No. 54/08, 122/08, 13/09, 104/09 and 17/10). The competent minister specifies these roads by the decision published in the Official Gazette of the Republic of Croatia.

Exceptionally roads which meet the provisions specified for the classification of public roads into state roads will be classified as state roads:

- roads which connect settlements,
- roads which connect areas within cities and settlements,
- public transport terminals,
- access roads leading to residential, business, commercial and other buildings,
- other roads in settlement and city areas.

Some authors believe that only the RA regulated for the first time the issues of defining an unclassified road and its ownership.

Article 101 regulates the legal status of unclassified roads as public goods in general use in the ownership of local self-government units within whose territory the road is situated.

Furthermore, the unclassified roads in the ownership of the local self-government units cannot be alienated nor can the proprietary rights of unclassified roads be acquired, with the exception of easement right and building right with the purpose of building constructions pursuant to the decision made by the executive body of the local self-government unit, provided that it doesn't obstruct traffic flow and maintenance of the unclassified road.

Exceptionally a part of the unclassified intended for the use of pedestrians (sidewalk and such) can be leased in accordance with the special provisions (Utility services regulations).

### **3.1 Registration of unclassified roads in the land registry (Article 102 of the RA)**

Unclassified road becomes a public good in general use upon the legal validity of the use permit, i.e. upon issuing of another act on the basis of which the use of the construction is permitted with respect to the special regulation.

Unclassified road is registered in the land registry books as a public good in general use and as an inalienable property of the local self-government unit. Local self-government units are municipalities and cities.

### **3.2 Termination of the public good in general use status of an unclassified road**

When the need for using an unclassified road or any of its parts permanently stops, its status of a public good in general use can be terminated, and the property, which loses its public good in general use status, remains in the ownership of the local self-government unit.

The resolution to terminate the public good in general use status of an unclassified road or its part is made by the representative body of the local self-government unit and it is delivered to the competent court in order to delete the public good in general use status of an unclassified road from the land registry. Representative bodies of the local self-government units are municipal and city council.

### **3.3 Registration of unclassified roads in the land registry according to the transitional and final provisions**

The RA's transitional and final provisions (Articles 131-133) include provisions regarding the registration of unclassified roads in the land registry books. Roads which were used on the date of the RA's entry into force for motor traffic under any conditions and which are accessible to a larger number of users, and which have not been classified as public roads within the meaning of the RA, became unclassified roads whereby the existing land registry records in the ownership of the local self-government unit should have been replaced ex officio by registration of the unclassified road, public good in general use, as an inalienable property of the local self-government unit.

Unclassified roads which were not registered in the land registry books or there was no record of their actual state, should have been registered in the land registry ex officio based on the application form which after the recording of the unclassified road, i.e. its actual state in the cadastre, is delivered ex officio to the land-registry court by the body responsible for the cadastre.

Unclassified roads which were not recorded in the cadastre or there was no record of their actual state, should have been recorded in the cadastre based on the appropriate geodetic survey analysing the current state, and which is obtained and delivered to the body responsible for the cadastre by the local self-government unit, i.e. legal entity authorised to manage the unclassified road.

This provision was amended by the AA RA/14 (Article 3) so that the land-registry court decision concerning the implementation of the application form is also required for the registration of respected roads in the cadastre.

Paragraph 5 of Article 131 of the RA was amended as well, so that the application form for the earlier implementation in the land-registry is delivered to the land-registry court ex officio by the competent cadastre office based on the reviewed and confirmed geodetic survey analysing the current state of the unclassified road.

Furthermore, a provision was added pursuant to which the unclassified roads referred to in Article 131, paragraph 1 will be registered in the land registry books as a public in general use, as an inalienable property of the local self-government unit with the registration of the legal entity managing the public road, regardless of the existing registration in the land registry books.

Article 132 of the RA stipulated that the existing registration in the cadastre and land registry regarding public roads, which became roads referred to in Article 98, paragraph 1, subparagraph 1 of the RA, should be replaced ex officio by the registration of the unclassified road, public good in general use, as an inalienable property of the local self-government unit based on the decision in Article 89, paragraph 2 of this Act.

Data regarding the land register plots which is required for the change of that registration in the land registry books is delivered ex officio to the land-registry court by the body responsible for the cadastre.

Roads referred to in Article 98, paragraph 1, subparagraph 1 of this Act, which are not recorded in the cadastre nor is there any record of their actual state, are recorded in the cadastre based on the decision in Article 98, paragraph 2 of the RA and the appropriate geodetic survey analysing the current state, and which is obtained and delivered to the body responsible for the cadastre by the local self-government unit, i.e. legal entity authorised to manage the unclassified road.

This provision was amended by the AA RA/14 (Article 4) so that the land-registry court decision concerning the implementation of the application form is also required for the registration of respected roads in the cadastre.

Amended was also paragraph 4 of Article 132 which specified that roads referred to in Article 98, paragraph 1, subparagraph 1 of the RA, which are not registered in the land registry books nor is there any record of their actual state, are recorded in the land registry ex officio based on application form which is after the recording of the unclassified road, i.e. its actual state in the cadastre, delivered ex officio to the land-registry court by the body responsible for the cadastre. According to the amended, valid provision, roads referred to in paragraph 3 of this Article will be registered in the land registry as a public good in general use, as an inalienable property of the local self-government unit with registration of the legal entity managing the public road, regardless of the existing registration in the land registry.

Article 5 of the AA RA/14 stipulates that the management of statements requiring implementation of an appropriate geodetic analysis in the land registry, and which are submitted to the land-registry court before the date of the AA RA/14's entry into force, are subject to the AA AR/14's regulations.



## 4 Conclusion

The issues regarding the legal ownership status of public roads regulated by the RA and its amendments don't cause any difficulties in its implementation. However, the issues concerning the legal ownership of unclassified roads after the RA's entry into force have posed a series of problems for the local self-government units, the practice of the cadastre, as well as land registry. The AA RA/14 amended and added the resolutions at issue "in order to ensure more effective practice of the cadastre offices and land-registry courts in proceedings (...)". Nevertheless, a series of issues regarding the legal status of unclassified roads still remains unresolved.

## References

- [1] Vedriš, M., Klarić, P.: Građansko pravo, Narodne novine, 2004.
- [2] Zakon o cestama (Narodne novine 84/11, 18/13, 22/13, 54/13, 148/13, 92/14).
- [3] Zakon o vlasništvu i drugim stvarnim pravima (Narodne novine 91/96, 68/98, 137/99, 22/00, 73/00, 114/01, 79/06, 141/06, 146/08, 38/09, 153/09, 90/10, 143/12, 152/14).
- [4] Zakon o zemljišnim knjigama (Narodne novine 91/96, 68/98, 137/99, 114/01, 100/04, 107/07, 152/08, 126/10, 55/13, 60/13).

## 10 CONSTRUCTION AND MAINTENANCE





## BITUMEN SELECTION APPROACH ASSESSING ITS RESISTANCE TO LOW TEMPERATURE CRACKING

Judita Gražulytė, Audrius Vaitkus, Igoris Kravcovas

*Vilnius Gediminas Technical University, Road Research Institute, Lithuania*

### Abstract

Low temperature cracking or thermal cracking is one of the most important distress in asphalt pavements located in cold regions. The development of it results in higher pavement roughness, faster pavement deterioration and requires millions of euros of repair and maintenance annually. The proper bitumen selection for asphalt mixture production restricts the formation of low temperature cracking. However, most designers do not consider bitumen susceptibility to low temperature cracking, because it needs to carry out additional laboratory tests and it requires supplementary cost and time in asphalt mixture selection. Consequently, this paper is focused on approach how to select bitumen assessing its resistance to low temperature cracking in easy and fast way. First, 11 bitumens of which 6 bitumens were polymer modified bitumens, were investigated. The critical temperature of bitumen, below which low temperature cracking occurs in the pavement, was calculated based on bending beam rheometer (BBR) experimental data by American Association of State and Highway Transportation (AASHTO) specifications. The performance grades (PG) low limits of bitumens were also determined using 3 °C step. The performance grade low limit varied from -16 °C up to -28 °C. Four polymer modified bitumens were not prone to low temperature cracking even at -28 °C temperature. Second, Lithuania was divided into 3 zones according to minimum pavement temperature. It gave possibility for designers to choose bitumen assessing its resistance to low temperature cracking based on road location. The implementation of this procedure will restrict low temperature cracking in asphalt pavements and will result in significant lower maintenance cost.

*Keywords: bitumen, thermal cracking, low temperature cracking, bending beam rheometer (BBR), critical temperature, performance grade*

### 1 Introduction

Low temperature cracking or thermal cracking is the dominant failure type in asphalt pavements located in cold regions. The opening and development of this kind distresses increase pavement roughness and create the opportunity for water penetration into pavement. It leads to lower bearing capacity of base and subbase, especially through freeze-thaw cycles, and results in faster pavement deterioration. The repair and maintenance of these consequences require millions of euros annually.

Low temperature cracking occurs because asphalt pavements contract under severe temperature changes. The crack opens when the thermal stress induced at low temperature exceeds the tensile strength of the asphalt pavement. Many researches [1-5] improved that bitumen performance at low temperature correlates very well with asphalt mixture performance at low-temperature and can be a specification in restriction of low temperature cracking. However, most designers, especially in Lithuania, do not consider bitumen susceptibility to low

temperature cracking, because it needs to carry out additional laboratory tests and it takes supplementary cost and time in asphalt mixture design.

These problems are solved applying the Strategic Highway Research Program (SHRP) Performance Grade (PG) specifications [4], which have been used in the USA since the 1990's. These bitumens are classified on the basis of the rheological properties measured in the linear viscoelastic range at pavement service temperatures. The bitumen criterion for low temperature cracking is based on Readshaw's work [3]. He concluded that low temperature cracking could be minimized by using bitumen which does not exceed 200 MPa stiffness after a loading time of 2 hours at the lowest pavement service temperature. SHRP research team adjusted this value up to 300 MPa and applied the time-temperature superposition principle. It means that bitumen stiffness at 60 seconds at  $T$  °C temperature is approximately equal to the stiffness at 2 hours at  $T-10$  °C temperature [4]. Furthermore, the  $m$ -value was introduced as an additional parameter. It should not be lower than 0.3 at the lowest pavement service temperature. Otherwise, bitumen too slowly relaxes the thermal stresses that build up at low temperatures.

Bitumen susceptibility to low temperature cracking is assessed by its critical cracking temperature, which is defined as the temperature, at which bitumen cannot withstand induced thermal stresses. The determination of critical cracking temperature depends on the test type and method [6-11]. According to current American Association of State Highway and Transportation Officials (AASHTO) specification critical cracking temperature of bitumen is determined using data from the bending beam rheometer (BBR) and the direct tension tester (DTT).

In Europe PG classification is not practically used. These bitumens are usually classified by penetration at 25 °C and softening point and there are not any requirements restricting low temperature cracking. The practice in Europe shows that the low temperature cracking might occur after 2-4 years since pavement construction even if bitumen meets requirements according to EN standards. Researchers [12], [13] tried to assess the performance of bitumens at low temperature based on the data from BBR. The investigation revealed that critical cracking temperature of unmodified bitumens varies from -13 °C up to -22 °C depending on penetration at 25 °C which was from 20 mm<sup>-1</sup> up to 70 mm<sup>-1</sup>. Modified bitumens represented lower critical cracking temperatures than unmodified bitumens. They were from -18 °C up to -29 °C. However, there were analysed only a small part of familiar bitumens usually used in Europe. Therefore, there is a need to conduct a wider experiment and to suggest a reasonable approach of bitumen selection assessing its resistance to low temperature cracking.

## 2 Experimental research of bitumen performance at low temperature

In experimental research were analysed 11 different bitumens, which are widely used in Europe: 5 – unmodified bitumens (20/30, 35/50, 50/70, 70/100 and 100/150), 4 – polymer modified bitumens (PMB 10/40-65, PMB 25/55-60, PMB 45/80-55 and PMB 45/80-65) and 2 – highly polymer modified bitumens (PMB 25/55-80 and PMB 45/80-80). Highly polymer modified bitumens are an innovation in road building materials industry and are not widely used. All analysed bitumens were characterized by:

- penetration at 25 °C temperature (EN 1426);
- softening point (EN 1427);
- elastic recovery (only polymer modified bitumens, EN 13398);
- critical cracking temperature;
- PG grade.

The critical cracking temperature was determined by data from BBR (EN 14771). The critical cracking temperature was a higher (less negative) temperature at which the creep stiffness at a loading time of 60 s was 300 MPa or  $m$ -value at a loading time of 60 s was 0.3 and 10 °C was subtracted due to used time-temperature superposition principle. Test temperature was

changed at 6 °C intervals such that  $S(60) \leq 300$  MPa or  $m(60) > 0.3$  at T °C and  $S(60) > 300$  MPa or  $m(60) < 0.3$  at T-6 °C. All bitumens before BBR were short and long term aged according to RTFOT (EN 12607-1) and PAV (14769). The classification into PG grades was done on the basis of critical cracking temperature. PG grades changed at 3 °C intervals.

### 3 Results

In experimental research determined characteristics of analysed bitumens are represented in Table 1. All analysed bitumens met European specification requirements of penetration at 25 °C temperature (EN 12591 and EN 14023). Unmodified bitumen 20/30 (25.1·mm<sup>-1</sup>) and polymer modified bitumen PMB 10/40–65 (26.9·mm<sup>-1</sup>) showed the lowest penetration. Bitumens with low penetration are hard and become brittle at low temperature. In cold regions are preferable softer bitumens because they are less susceptible to low temperature cracking.

All analysed bitumens except bitumen 20/30 met European specification requirements of softening point (EN 12591 and EN 14023). The softening point of unmodified bitumen 20/30 (63.6 °C) was higher than the European specification requirement (from 55 °C up to 63 °C).

**Table 1** Characteristics of bitumens

Bitumen	Penetration [mm <sup>1</sup> ]	Softening point [°C]	Elastic recovery [%]	$T_{\text{limiting}} -10$ [°C]		$T_{\text{cr}}$ [°C]	Low temperature PG
				S(60)	m(60)		
20/30	25.1	63.6	–	-24.73	-16.56	-16.56	-16
35/50	39.0	54.4	–	-26.02	-23.25	-23.25	-22
50/70	59.7	49.6	–	-26.98	-24.98	-24.98	-22
70/100	81.7	46.0	–	-28.17	-27.60	-27.60	-25
100/150	123.0	42.3	–	-28.81	-29.65	-28.81	-28
PMB 10/40–65	26.9	71.1	73	-26.86	-21.28	-21.28	-19
PMB 25/55–60	33.7	63.9	79	-26.64	-22.99	-22.99	-22
PMB 45/80–55	64.7	64.5	90	-28.58	-27.52	-27.52	-25
PMB 45/80–65	57.8	73.7	90	-28.83	-28.26	-28.26	-28
PMB 25/55–80	40.8	98.7	94	-28.97	-28.20	-28.20	-28
PMB 45/80–80	59.8	91.2	96	-30.09	-28.75	-28.75	-28

All analysed modified bitumens represented higher than 63.5°C softening point. Highly modified bitumen PMB 25/55–80 showed the best result (98.7 °C).

According to the European specification requirements (EN 14023), there is required not less than 50% elastic recovery of polymer modified bitumen. All analysed polymer modified bitumens recovered more than 70%. Highly modified bitumen PMB 25/55–80 and PMB 45/80–80 demonstrated even 94% and 96% elastic recovery.

In 90.9% cases, limiting temperature determined by m-value at 60 s was higher than limiting temperature determined by stiffness at 60 s. Thus, m-value was a decisive factor determining critical cracking temperature.

The determined critical cracking temperature and PG grade for analysed bitumens showed their reasonable usage. Unmodified bitumen 100/150, polymer modified bitumen PMB 45/80–65 and highly polymer modified bitumen PMB 25/55–80 and PMB 45/80–80 are not prone to low temperature cracking at higher than -28 °C pavement temperature. Meanwhile, the bitumen 20/30 can be used only at higher than -16 °C pavement temperature.

## 4 Bitumen selection for asphalt mixture production

Low temperature cracking in asphalt pavements is minimized ensuring critical cracking temperature lower than minimum pavement design temperature. Minimum pavement design temperature is 1-day-minimum pavement temperature measured at the pavement surface at the project location. Usually temperature at the pavement surface is measured in Road Weather Stations (RWSs). If there is available data of meteorological stations, air temperatures have to be converted to the pavement temperatures at the pavement surface.

The determination of minimum pavement design temperature at any project location is simplified if mapping is done. The country is zoned considering to long period (10, 20 or more years) data of 1-day-minimum pavement temperature measured at the pavement surface in the RWSs. Typically, the intervals change in the same high as for PG grades.

In Lithuania RWSs were started to install in 1999. RWSs have temperature sensors at the pavement surface. Therefore, the lowest temperatures at the pavement surface of 2005–2015 years were analysed. The temperature repeatability in each interval of 2.5 °C below -15 °C was also analysed. It enabled to eliminate errors. For example, in RWS “Seirijai” the lowest temperature during 2005–2015 period was -26 °C in 2012. However, this temperature was recorded only one time and other low temperatures are higher than -20 °C. Thus, -19 °C that was recorded in 2014 was assumed as the lowest temperature during 2005–2015 period instead of -26 °C.



Figure 1 Lithuanian mapping according to minimum pavement design temperature

The lowest temperatures in 29 RWSs during 2005–2015 period are represented in Table 2. Lithuania was mapped using Autocad Civil 3D. The surface was smoothed using the Kriging method which provides spherical semivariogram model. Lithuania was zoned into 3 zones (Fig. 1). The highest low temperature zone (-19 °C) is in the North-east of Lithuania (in Ukmergė and Rokiškis region). The highest part of Lithuania (along coastal, Samogitian Highlands and the West-east of Lithuania) belongs to zone of -22 °C. The lowest pavement temperatures (up to -25 °C) are in the North-east of Midstream Lithuanian Lowland and in Pabradė, Vilnius, and Druskininkai region. The low temperature in RWS “Kryžkalnis” was significantly lower than in surrounding area. Thus, we referred this point to zone of -25 °C. However, the temperature data and conditions that may influence the results have to be detailed because pavement

temperature lower than -25 °C was recorded more than 120 times during 2005–2015 period. If the correctness of such low temperature (<-25 °C) in “Kryžkalis” is proved, the adjustment of map has to be done. Furthermore, the map has to be updated yearly if any significant changes in the lowest pavement temperature appear.

In each zone has to be used bitumen which low critical cracking temperature is lower than minimum pavement design temperature. The reasonable selection of analysed bitumen for asphalt mixture production according to zone is represented in Table 3.

**Table 2** The lowest pavement temperature in RWSs during 2005–2015 period

RWS No.	RWS name	The lowest pavement temperature [°C]
981	Šventoji	-21.5
989	Skirsnemunė	-21.5
1012	Bubiai	-25.2
1015	Panemunė	-25.9
1042	Pirčiupiai	-20.8
1063	Druskininkai	-23.2
1066	Telšiai	-21.9
1068	Dieveniškės	-19.6
1071	Puskelniai	-20.0
1104	Pabradė	-25.6
1123	Rokiškis	-14.7
1125	Daugailiai	-19.4
1129	Saločiai	23.7
1132	Maišiagala	-18.5
1134	Širvintos	-19.1
1135	Ukmergė	-15.4
1138	Kučgalys	-16.8
1140	Seirijai	-19.0
1143	Šėta	-23.4
1164	Didžiulio ež.	-24.2
1168	Šilagalys	-23.5
1181	Rumšiškės	-17.9
1183	Gynėvė	-22.1
1185	Kryžkalis	-28.2
1187	Klaipėda	-21.0
1206	Babtai	-17.0
1208	Bačkonys	-23.7
1209	AMV	-22.0
1222	Užventis	-16.4

**Table 3** Bitumen usage according to zone

Zone	Bitumen
-19	35/50, 50/70, 70/100, 100/150 PMB 10/40–65, PMB 25/55–60, PMB 45/80–55, PMB 45/80–65, PMB 25/55–80, PMB 45/80–80
-22	35/50, 50/70, 70/100, 100/150 PMB 25/55–60, PMB 45/80–55, PMB 45/80–65, PMB 25/55–80, PMB 45/80–80
-25	70/100, 100/150 PMB 45/80–55, PMB 45/80–65, PMB 25/55–80, PMB 45/80–80



## 5 Conclusions

Bitumen classification by penetration and softening point does not represent bitumen performance at low temperatures. There is a need to classify bitumens based on the performance parameter that could restrict low temperature cracking. Critical cracking temperature, which is defined as the temperature at which bitumen cannot withstand induced thermal stresses, could be the key assessing its resistance to low temperature cracking.

All analysed bitumens met European specification requirements of penetration at 25 °C temperature and softening point except unmodified bitumen 20/30 that had 0.6 °C higher softening point. However, softening point is not a decisive factor in low temperature cracking.

The determined critical cracking temperature by BBR data varied from -16.56 °C to -28.81 °C. Maximum difference is 12.25 °C. It confirms the hypothesis that bitumen for asphalt mixture production has to be selected assessing its resistance to low temperature cracking.

In 90.9% cases, limiting temperature determined by m-value at 60 s was higher than limiting temperature determined by stiffness at 60 s. Thus, m-value was a decisive factor determining critical cracking temperature.

Based on the lowest temperatures from 29 RWSs during 2005–2015 period Lithuanian territory divided to three regions. The highest low temperature zone (-19 °C) is in the North-east of Lithuania. The lowest pavement temperatures (from -22 °C to -25 °C) are in the North-east of Midstream Lithuanian Lowland and in Pabradė, Vilnius, and Druskininkai region. The medium low temperature zone (-22 °C) is in the rest part of Lithuania.

Setting low temperature regions of the country data has to be analysed after each winter and if lower pavement temperature was recorded in comparison with the introduced values in 29 RWSs, the map has to be updated.

In zone of -19 °C can be used all analysed bitumens except unmodified bitumen 20/30. This bitumen is not appropriate for Lithuanian climate on the basis of BBR test. In zone of -22 °C unmodified bitumen 20/30 and polymer modified bitumen PMB 10/40–65 tend to low temperature cracking. In zone of -25 °C zone only unmodified bitumen 70/100, 100/150, polymer modified bitumen PMB 45/80-55 and PMB 45/80-65, and highly polymer modified bitumen PMB 25/55-80 and PMB 45/80-80 can be used. Critical cracking temperature for all analysed bitumens was determined by data from BBR on the basis of m-value and stiffness at 60 s after 1 h conditioning. This experimental research has to be extended carrying out direct tension test and applying other methods for critical cracking temperature determination.

## References

- [1] Jung, D., Vinson, T.S.: Low Temperature Cracking Resistance of Asphalt Concrete Mixtures, *Journal of the Association of Asphalt Paving Technologists*, 62, pp. 54–92, 1993.
- [2] Falchetto, A.C., Turos, M.I., Marasteanu, M.O.: Investigation on Asphalt Binder Strength at Low Temperatures, *Road Materials and Pavement Design*, 13(4), pp. 804–816, 2012, doi: 10.1080/14680629.2012.735793
- [3] Readshaw, E.E.: Asphalt Specifications in British Columbia for Low Temperature Performance, *Association of Asphalt Paving Technologists Proc.*, pp. 562–581, 1972.
- [4] Anderson, D.A., Kennedy, T.: Development of SHRP Binder Specification, *Journal of the Association of Asphalt Paving Technologists*, 62, pp. 481–507, 1993.
- [5] Behnia, B., Dave, E.V., Buttlar, W.G., Reis, H.: Characterization of Embrittlement Temperature of Asphalt Materials through Implementation of Acoustic Emission Technique, *Construction and Building Materials*, 111, pp. 147–152, 2016, doi: 10.1016/j.conbuildmat.2016.02.105.
- [6] Lee, N., Hesp, S.A.M.: Low Temperature Fracture Toughness of Polyethylene-modified Asphalt Binders, *Transportation Research Record*, 1436, pp. 54–59, 1994.

- [7] Petersen, J.C., Robertson, R.E., Branthaver, J.F., Harnsberger, P.M., Duvall, J.J., Kim, S.S., Anderson, D., Christensen, D.W., Bahia, H.U., Dongre, R.: Binder Characterisation and Evaluation, vol 4: Test Methods, Washington, D.C.: Strategic Highway Research Program. National Research Council, SHRP-A-370, 1994.
- [8] Kim, S.-S.: Direct Measurement of Asphalt Binder Thermal Cracking, *Journal of Materials in Civil Engineering*, 17 (2005), pp. 632–639, doi: 10.1061/(ASCE)0899-1561(2005)17:6(632)
- [9] Gauthier, G., Anderson, D.A.: Fracture Mechanics and Asphalt Binders, *Road Materials and Pavement Design*, 7 (2006) 1, pp. 9–35, doi: 10.1080/14680629.2006.9690056
- [10] Mitchell, M. R., Link, R. E., Zofka, A., Marasteanu, M.: Development of Double Edge Notched Tension (DENT) Test for Asphalt Binders, *Journal of Testing and Evaluation*, 35 (2007) 3, pp. 1-7, doi: 10.1520/JTE100678
- [11] Sui, C., Farrar, M. J., Tuminello, W. H., Turner, T. F.: New Technique for Measuring Low-Temperature Properties of Asphalt Binders with Small Amounts of Material, *Transportation Research Record: Journal of the Transportation Research Board*, 2179, 2010, doi: 10.3141/2179-03
- [12] Radziszewski, P., Kowalski, K. J., Król, J. B., Sarnowski, M., Piłat, J.: Quality Assessment of Bituminous Binders Based on the Viscoelastic Properties: Polish Experience, *Journal of Civil Engineering and Management*, 20 (2014) 1, pp. 111–120, doi: 10.3846/13923730.2013.843586
- [13] Olard, F., Di Benedetto, H., Eckmann, B., Triquigneaux, J.-P.: Linear Viscoelastic Properties of Bituminous Binders and Mixtures at Low and Intermediate Temperatures, *Road Materials and Pavement Design*, 4 (2003) 1, pp. 77–107, doi: 10.1080/14680629.2003.9689941





## HOLISTIC APPROACH TO TRACK CONDITION DATA COLLECTION AND ANALYSIS

Janusz Madejski

*GRAW, Silesian University of Technology in Gliwice, Poland*

### Abstract

Track geometry measurements are made using the manual tools, microprocessor based portable instruments, and geometry cars. However, no measurement method or tool without data logging feature, is capable to collect all data that would be necessary for the detailed diagnostic reasoning in a line or railway network level, being useful only for direct measurement of some track parameter at a particular point. Microprocessor based track gauges, trolleys or self-propelled geometry cars, or else measurements and inspection equipment mounted on the regular trains, can record all aspects of track condition.

Timely use of this data is the source of the cost efficient and rational maintenance decisions. Moreover, the earlier the necessary repair is done, the less expensive it will be. Therefore, expenditures on measurement equipment and data repository systems are the most effective investment – saving costs of possible accidents and costly repairs if they are made late. This is even more evident in the case of track network revitalization, as one has to decide where and what should be repaired first.

Operating safety may be ensured only if the actual track condition is known. This requirement calls for easy access over internet on various platforms to measurement data – current and historical – and also to results of their analyses. These include, among others, also results of image analysis of streaming visual inspection. They can later be reported on plots and tabular reports so that maintenance service can efficiently locate specific locations needing maintenance. Some analyses require application of the artificial intelligence methods.

*Keywords: track condition, track diagnostics, track maintenance, video inspection, track geometry*

### 1 Introduction

The safe, dependable track must be a given for all rail transport, be it for a high-speed line or a less used rural line. Review, maintenance, and renewal of track is, therefore, a crucial, but additionally a vital, cost to railways. The search carries on for more cost-efficient ways to maintain the appropriate track condition at the lowest through life cost. One facet of this is to develop strategies which require less track possession time. This is becoming ever more important as rail transport infrastructure owners strive to improve capacity on existing lines. The appropriate maintenance is the governing factor of the long service life of the track components.

The main issue with the preventive maintenance approach being the common approach is that in many cases, corrective action is taken when there is no need, sometimes resulting in unnecessary maintenance. The unnecessary maintenance can become even more costly if the secondary damage happens during the replacement. The condition-based maintenance eliminates this problem, as the repair can be planned at a time that minimizes the impact on track use to use its components to the limit of their service life. Improvements in quality,

profitability, and productivity result when this approach is used on capital-intensive assets, like railway infrastructure. This approach requires the continuous stream of reliable data describing the current track condition in as many aspects as possible. The issue now is what data sources should be considered and how should the infrastructure condition analysis results be made available to their relevant recipients.

## 2 Data sources

There are a number of reliable data sources available nowadays, differing with the scope of information they can provide, volume of measurement data, and their effect on the measured track. Their price and availability feature usually the governing factors for potential users – see Table 1. The main advantages of the affordably priced trolleys and self-propelled carts are that they can be used immediately whenever required, while the costly track recording cars are used mainly for the track network regular inspections [1, 4, 5, 6, 11, 12, 14].

**Table 1** Features of various track condition measuring devices and systems.

Features	Trolleys	Self-propelled carts, towed platforms	Track recording cars
Cost	low	medium	high
Measurement systems	1 – 4	1 – 6	16+
Load to the measured track	negligible	modest	full
Operating speed	4 km/h	16 km/h	high
Volume of measurement data	low	medium	high
Track possession	required	required	like a train

Another issue is the volume of the measurement data obtained per shift. In case of the trolleys it may be up to 100 KB, while in case of devices equipped also with the rail head wear systems it may be 100 MB or more. Track recording cars, equipped with video inspection systems may generate even up to 100 GB in the comparable time. Therefore, careful planning is required concerning collection of the data, its processing, backup, analysis, reporting, and providing access to the analyses of the measurement data.

The data is collected in various formats, beginning from simple text files (simple manual track gauges, some trolleys), proprietary format track geometry files (most trolleys, and measurement systems of carts and track recording vehicles), and results of video inspection saved as AVI files with the possibility of exporting images to BMP or JPG formats. The video inspection data is usually pre-edited by tagging them with information about line and track ID, actual mileage, date, time, etc.

Another issue is the way in which the data may be used by the diagnosticians. Data collected with trolleys are usually in a form of the separate files for each measurement. They may be compared, merged, yet usually they are collected by the base railway diagnostic unit and only their analysis results are shared with the higher level. The same applies usually to data obtained from the self-propelled carts, while data collected by track recording vehicles are usually stored in dedicated databases.

## 3 Data storage and processing

Many countries have been exerting significant efforts to improve the potential of the track maintenance systems employed [13, 15, 16]. Making the best use of measurement data collected from all data sources calls for their centralized storage. Good examples of such approach are the turnout database used by the Danish State Railways or the track maintenance database used by Inspection company in The Netherlands.

Experience shows that, apart from the reliable data collection systems, it is important to develop and implement the efficient IT system that can cope with the huge amount of the data being collected continuously and making possible to process efficiently the collected data. The main tasks may include:

- development and checkup of the inspection schedules,
- checkup of carrying out of the inspections for the selected routes,
- splitting the video streams into the separate images with extraction of the pre-defined infrastructure elements,
- fast viewer for the measurement results,
- marking and classification of the detected defects,
- reporting,
- data archiving,
- making backup copies.

The data storage and processing system for such applications may be developed based on the synchronous or asynchronous models. The synchronous model is best used for:

- query processing,
- when the result is needed for subsequent processing,
- user interface.

The asynchronous model is used in all other cases. This model is used, e.g., for application to application communications. Such approach also hides mismatches in system availability, performance, etc., moreover it is essential for more complex, multi-party interactions. The Application Server shown below meets all these requirements and important advantages are (see Figure 1):

- a number of users (Clients) may access the same data simultaneously; an important feature of Tier 1 is that only the 'thin' Client applications are used – in fact any device with an Internet browser may be used, be it a PC, Android or iOS tablet, or a smartphone,
- all software used for query and data processing – Tier 2 – is continuously updated, so the users access on-line only the newest versions of applications, so there is no search for the latest versions of data processing software by the users, and any bugs may be quickly corrected as soon as possible,
- databases reside on servers – Tier 3 – with the necessary data backup assured, providing the required data security, short data access and processing time.

Many applications on Tier 2 might include the distributed societies of relatively simple software agents. This approach is present since some time in transportation applications [8, 9]. Most of the inspection data, be it track and turnout geometry readings, and video inspection information can be analysed automatically by the dedicated agents. The goal is to focus the diagnostic engineers' attention on the detected problems, relieving them from the tedious task of sifting through voluminous data. Examples of problems that may be detected by such agents include, among others [2, 3, 5]:

- exceedings of values of the track and turnout geometrical parameters,
- potentially hazardous occurrences of apparently unarmful values of parameters, yet which together may reduce safety of operation,
- determining locations in the track network where its geometrical parameters deterioration trend is either bigger than in other similar locations, or has just begun growing,
- generation of reviews of staff annotations to track defects made during the selected period, e.g., last shift,
- image processing to detect problems with rail fixtures, e.g., missing elements,
- image processing to detect rail head defects.

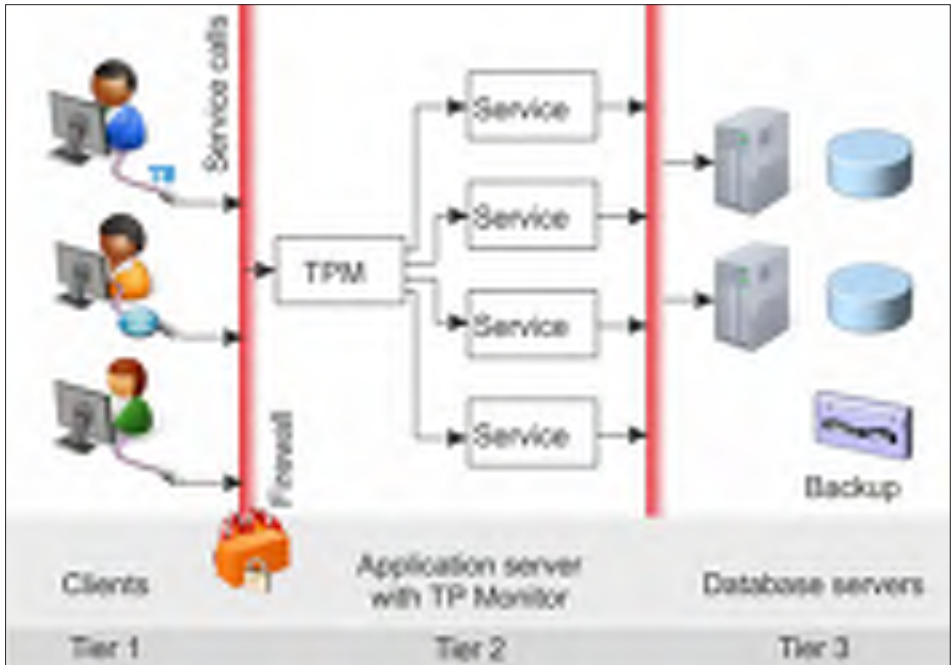


Figure 1 Infrastructure maintenance data system with the Application Server architecture

#### 4 Data access

The track condition data is continuously updated and the latest information has to be available to many different classes of users – an example of the multi-platform user interface is shown using the GRAW WEB Geotec system (see Figures 2 – 5). The system is accessed over Internet, providing access to users according to their relevant access rights.



Figure 2 Exemplary measurement data as presented on a PC with MS Win 10

There are a number of pre-defined reports available, yet the user can develop custom ones, composed of the basic modules, like chart panels, data tables, images, tamping information, etc.

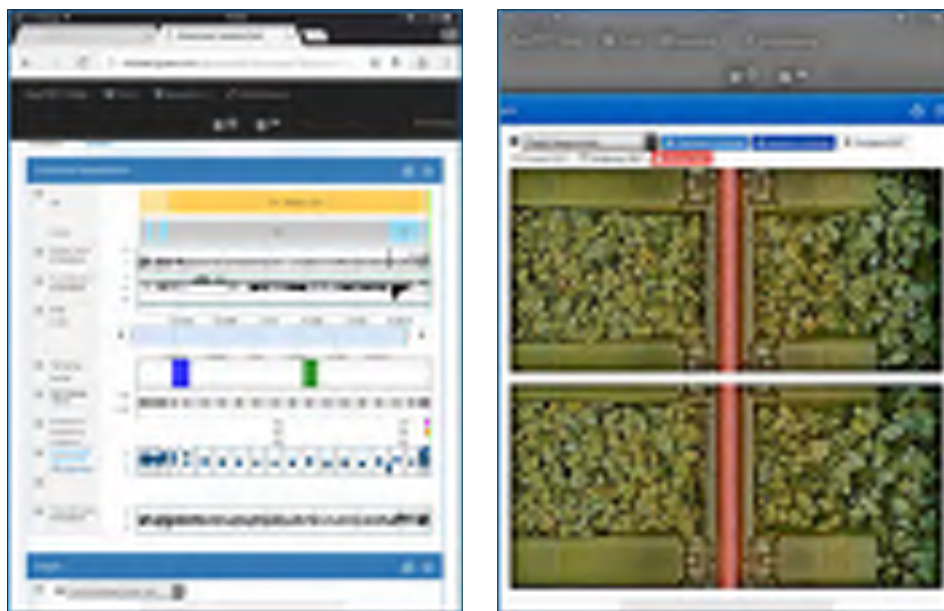


Figure 3 Exemplary measurement and video inspection data as accessed from an iPad tablet with iOS



Figure 4 Exemplary measurement data as accessed from a BlackBerry Q10 smartphone with QNX

Contents of all reports may be viewed also on smartphones. Let us limit our considerations to maintenance and repairs of the permanent way only here. – all information contained in such reports is always up-to-date, so job orders may be issued with no delay, with all defect information available over Internet, taking into account the latest information – and historical as well, if needed.





**Figure 5** Video inspection results analysis – synchronised with track geometry measurement, and other data

The real systems are complex and dynamic with a big number of events and processes, with many organisational levels, and subject to random disturbances. One may name some of these disturbances like new orders which may come based on permanent way inspection on a previous night, those queued already may be cancelled; some jobs may become more or less important with time, according to the dynamic priority rules [7, 8]. Moreover, some resources may temporarily become unavailable as deliveries may be delayed, raw materials may be depleted, tools may not be available for some reasons, to name but a few of them: staff may be absent, equipment service life may be reduced due to poor quality or misuse, and many others [9, 10].

Track condition data is available which may be collected by trolleys, self-propelled carts, track recording cars – all processed by the relevant applications and presented in the required format. Such processing may be done by maintenance engineers – diagnosticians, and/or – in part – by the artificial software agents..

## 5 Conclusions

The holistic approach to track condition data collection and analysis calls for the reliable data sources, efficient data processing software, and readily available user interface. The multi-agent data processing systems may consist of both human and software agents. Therefore, solving the communication problem between these two types of agents is the key issue. One of the solutions is development of the efficient data base systems and an application layer in which the automatic data processing may take place also without human involvement.

## References

- [1] Auer, F.: Multi-function track recording cars, *Railway Technical Review*, 3+4/2013 ,pp. 32 – 36
- [2] Bałuch, H.: Synthetic Methods for the Evaluation of the Railway Track (Syntetyczne metody oceny nawierzchni kolejowej), *Problemy Kolejnictwa, Zeszyt 166*, March 2015, pp. 7 – 23 (in Polish)

- [3] Bednarek, W.A.: The problems of arising vertical irregularities in operating railway track (Zagadnienia powstających pionowych nierówności w eksploatawanym torze kolejowym), *Przegląd Komunikacyjny* 2016 No 2, pp. 18 – 26 (in Polish)
- [4] Burghardt, J., Iwaskiewicz, M., Madejski, J.: System for the Real Time Railway Track Geometry Parameters Evaluation, *International Conference On Signal Processing Applications and Technology*; Boston, MA, USA, October 7-10, 1996, pp. 1821-1825
- [5] Esveld, C.: *Modern Railway Track*, 2<sup>nd</sup> ed., TU-Delft, 2001
- [6] GRAW: <http://www.graw.com/index.php/pl/turnout-measurement-system-tms.html>
- [7] Jovanovic, S.: *Railway Track Quality Assessment and Related Decision Making*, 2004 IEEE International Conference on Systems, Man and Cybernetics, 10-13 Oct, 2004, 5038 – 5043 vol.6
- [8] Madejski, J.: Track Geometry Measurement as Preventive Maintenance Data Source, *Proceedings of CETRA 2014, 3<sup>rd</sup> International Conference on Road and Rail Infrastructure*, pp. 97-103, 2014.
- [9] Madejski, J.: Potential of Multi-Agent Systems for Operation of Transportation Systems, *Pomiary Automatyka Robotyka*, R. 20, No 1/2016, 31–36, DOI: 10.14313/PAR\_219/31, pp. 31-36, 2016
- [10] Marik, V., Vrba, P., Hall, K.H., Maturana, F.: Rockwell Automation Agents for Manufacturing, *Proceedings of AAMAS 05 – 4<sup>th</sup> International Joint Conference on Autonomous Agents and Multiagent Systems*, Utrecht University, 25-29 July, 2005, pp. 107-113
- [11] MER MEC S. p. A.: <http://www.mermecgroup.com/15/1/inspection-technology.php>
- [12] MATISA: Track auscultation concepts and technologies, [http://www.matisa.ch/brochure/en/vehicules\\_auscultation\\_en.pdf](http://www.matisa.ch/brochure/en/vehicules_auscultation_en.pdf)
- [13] Nielsen, J., Berggren, E., Lolgen, T., Muller, R., Stallaert, B., Pesqueux, L.: Overview of Methods for Measurement of Track Irregularities Important for Ground-Borne Vibration – RIVAS – SCP0-GA-2010-265754, Chalmers University of Technology, Trafikverket, DB, SBB, D2S International, Alstom RIVAS\_CHALMERS\_WP2\_D2\_5\_2, June 2<sup>nd</sup>, 2013
- [14] TEP Trolley: <http://www.graw.com/index.php/en/tep-trolley.html>
- [15] Tzanakakis, K.: *The Railway Track and Its Long Term Behaviour: A Handbook for a Railway Track of High Quality* (Springer Tracts on Transportation and Traffic), Springer, 2013
- [16] USA Department of Defense: Unified Facilities Criteria (UFC) – Railroad Track Maintenance & Safety Standards, UFC 4-860-03: [https://www.wbdg.org/ccb/DOD/UFC/ufc\\_4\\_860\\_03.pdf](https://www.wbdg.org/ccb/DOD/UFC/ufc_4_860_03.pdf), 13 February 2008





## RELATIONSHIP BETWEEN LIFESPAN AND MECHANICAL PERFORMANCE OF RAILWAY BALLAST AGGREGATE

Vaidas Ramūnas<sup>1</sup>, Audrius Vaitkus<sup>2</sup>, Alfredas Laurinavičius<sup>1</sup>, Donatas Čygas<sup>1</sup>

<sup>1</sup> Vilnius Gediminas Technical University, Dept of Roads, Lithuania

<sup>2</sup> Vilnius Gediminas Technical University, Road Research Institute, Lithuania

### Abstract

As the lifespan is main criterion for selection of the aggregate for ballast and for planning the maintenance of the railroad, it is important to define relationship between the particle load resistant characteristics and ballast's lifetime in structure. Assessment of the quality of the ballast particles under dynamic and static loading should reflect both, the toughness and hardness, and these can be identified with the values of Los Angeles Abrasion and micro-Deval Abrasion. In order to predict the amount of loads, expressed in cumulated tonnes, the model formerly developed by Canadian Pacific Railroads was adapted. A number of different aggregate mixtures were tested in the laboratory including dolomite and granite rocks. The results were used to assess the gross tonnage possible to transport during the lifetime of ballast until repair or reconstruction should be done. The outcome of this study is the possibility to classify the requirements for aggregates' Los Angeles abrasion and micro-Deval abrasion values attributing them to designed traffic volumes.

*Keywords: ballast, lifespan, Los Angeles, micro-Deval, aggregate selection*

### 1 Introduction

The use of poor quality ballast leads to shorter tamping intervals, a shorter ballast lifespan, and thus to increased life cycle costs. Railway companies employ specific quality control testing methods [1] in order to ensure the desired mechanical behaviour (i.e. resistance to fragmentation and to abrasion). In part, such tests have been used without change for several decades. The tests are meant to simulate the loads acting upon the ballast in track. Some tests results are highly variable and often show poor repeatability. The reasons for this remain undefined. Several possibilities for improvement have been suggested, for example, use of alternative test evaluation methods, adjustment of test procedures, and even the use of completely new test methods [2]. Assessing the suitability of crushed stone to equip ballast aggregate, it is usually required to determine the conformity of all its characteristics to standard requirements. However, seeking to select the suitable crushed stone, the mechanical properties of ballast aggregate become the most important, which most determine the functioning of all prism of ballast during operation. Aiming to classify the mechanical properties under the prospective cumulative traffic flows, the relation between mechanical properties and lifespan of ballast has to be identified. The usage of such classification will provide the opportunity to select the suitable mixture of crushed stone to equip prism of ballast of the railway with respect to supposed cumulative traffic flow during design time.

Without exception, every ballast specification attempts to assess the quality of the ballast particles under loading. Ideally, this quality measure should reflect both, the hardness and toughness of the ballast particles. The typical tests that are performed on a mix of the particles

by railroads worldwide include impact testing, crushing value testing, Los Angeles Abrasion testing, and the like. Though, only toughness of the ballast aggregation is basically set by these tests, whilst hardness of minerals has very low influence to the results of these tests. For any couple of these tests (e.g. Los Angeles Abrasion and Impact Factor in accordance with EN 1097-2:2010 [3]) pretty strong correlation is received [4], so it is enough to perform one of these tests and Los Angeles Abrasion (LAA) test is most often chosen in practice.

The field break down from the harder mineral rock is often slower because less powdering occurs at the points of contact between particles, and the broken particles are more angular and coarser resulting in a slower rate of track fouling [5]. Comparing ballast aggregates, which values of LAA are equal, ballast, made of harder mineral grains, shows better results under the fieldwork [6]. Therefore, the comparison of materials, only assessing the values of LAA and resistance to dynamic crushing, which essentially specify toughness of rock, does not ensure selection of the most appropriate material. Rocks are made of minerals, having different hardness values, therefore the method, allowing to evaluate rock's overall hardness, has been needed. This has been achieved by application of Mil Abrasion test, generally used in mining industry [7]. The indicator, showing particles resistance to wear due to grinding, is measured by this test.

## 2 Resistance to fragmentation and wear

Resistance to fragmentation. The main reasons for ballast degradation are ballast fragmentation and wear. They destine settlement of a road and increase expenses for maintenance of trackway geometry. The indicator of particles resistance to fragmentation, coefficient of Los Angeles (LAA), is determined applying Los Angeles test under standard LST EN 1097-2:2010 [3]. It is intended to assess the strength of ballast particles and potency not to crack under sleeper. However, additional tests are needed to use in order to measure degradation of ballast concerning wear, which is influenced by particles grinding between. Inner interaction of particles is unavoidable mechanism of ballast degradation.

Resistance to wear. Ballast construction stability is reflected by MA test and particles resistance to wear due to grinding is determined by this test. The concept of MA test is based on micro-Deval ( $M_{DE}$ ) test [8]. MA and Micro-deval assays equally allow to determine the resistance to wear avoiding fragmentation (or it is imperceptible). Particles resistance to fragmentation is better measured by LAA tests. It has been identified that MA partially correlates with results of Deval test [9]. MA is the test of wet particles wear because of grinding. This test is performed by spinning 3,0 kg of ballast aggregate (fraction 19/37,5 mm) and 3,0 l of water in a porcelain jar 10.000 times. Concerning the spinning of a porcelain jar, ballast particles wrestle one over other and wear avoiding significant fragmentation of particles, taking place at time of LAA test [10].

Alternatively, ballast aggregate could be assessed to analogical resistance to wear due to grinding, applying micro-Deval test, which is described in EN 1097-1:2011 [8] and ASTM D6928-10 [11].  $M_{DE}$  test is performed by spinning of 10 kg ballast aggregate (fraction 31,5/50 mm) and 2,0 l of water in a metal jar 10.000 times. Spinning metal jar, ballast particles wrestle one over other and wear as in time of MA test, avoiding significant fragmentation of particles.

## 3 Prognostic model of ballast aggregate lifespan

Rocks having a predominance of hard minerals were noted to have low MA values. Rocks having similar minerals were also noted to have a variation in values based on their degree of induration or compactness, which added to the significance of the test in terms of assessing rock hardness [6]. These observations mean that operating the probable performance of ballast aggregate on a road needs to be assessed combining the results of LAA and MA tests. The study of ballast degradation has been performed by Canadian Pacific Railroads (CPR)

order [12]. There has been determined that different rocks' relative performance, intended to ballast aggregate, could be represented by Abrasion Number ( $N_A$ ), which is determined as the sum of LAA value and 5 MA values:

$$N_A = LAA + 5 \times MA \quad (1)$$

Where:

$N_A$  – Abrasion Number, %;  
 LAA – Los Angeles Abrasion value, %;  
 MA – Mill Abrasion value, %.

Procedures of MA test [9] and determination of  $N_A$  indicator have been included into CPR normative specifications. CPR has connected  $N_A$  values of used material for ballast aggregation with observed life of ballast, which is expressed in accumulated traffic flow MGT (Million Gross Tons) to result in breakdown to the point where the ballast needed renewal. Lifespan has been determined to ballast that is under wooden sleepers. Railway sections have not been included into the latter study, which were severely affected by environmental factors and/or heavily fouled by outside fouling sources. Furthermore, the model doesn't assess ballast fouling by fine particles due to ballast tamping under the sleeper, done during the routine repairs, seeking to rebuild the track geometry. However, the received results allow to prognosticate ballast lifespan under ideal operating conditions, whereas comparing lifespan indicators of different aggregates it is possible to select the suitable option from both the economic and engineering points of view.

$$\text{Life} = 10^6 \exp(8.08 - 0.0382 N_A) \quad (2)$$

Where:

Life – lifespan of the ballast, expressed in accumulated traffic flow MGT.

Seeking to adapt CPR model for use in Lithuania, correction coefficients are used. Description and assumptions, applied to calculations, are presented further.

**Measurement units.** Calculating by analysed model, the results are received by widely used mass measurement unit “Short ton” (marking ton): 1 ton = 0.9074847 t = 907.1847 kg. It is accepted in Europe that 1 t = 1000 kg, so correction coefficient:  $A = 1000/907,1847$  has to be applied to calculation model of ballast lifespan. It is accepted that  $A = 1,102$ .

**Axle load.** CPR used model has been adapted to maximum axle load of 30 tones. Maximum axle load of 25 t is applied in Lithuania, so it is needed to determine correction coefficient B that will allow assessing the difference between permissible axle loads. The impact to ballast is approximately equal to half impact for track [13], and ballast degradation directly affects geometry of a road. Besides, 10 % increase in ballast stress conditions faster decrease of the road geometry quality from 1,2 to 1,5 time. The examined model is applied to greater axle load of 20 % than permissible axle load of 25 t in Lithuania. Therefore, ballast degradation, when maximum 25 t axle load is allowed, will be at least slower of B times:  $B = 1 + 0,2 \times 2 = 1,400$ . It is accepted  $B = 1,400$ .

**Sleepers.** Used model of CPR has been applied to prognosticate ballast lifespan, when wooden sleepers are used to superstructure. Therefore, correction coefficient C has to be determined, allowing to assess the influence of sleepers' type. Using concrete sleepers, dynamic loads and stresses in ballast are up to 25 % greater than using wooden sleepers [14], so ballast degradation under concrete sleepers will be at least C times faster (than at wooden tracks):  $C = 1 + 0,2 \times 2,5 = 1,500$ . Correction coefficient, reverse to value C:  $C^{-1} = 1/1,500 = 2/3$  is taken for adjustment of lifespan calculation model. It is accepted that  $C^{-1} = 0,667$ .

**Determination of the resistance to wear.** There were not found previous studies where the received results' relation is determined by MA and micro-Deval tests. However, it is known that MA test concept is based on micro-Deval ( $M_{DE}$ ) test [6,12]. Indicators of the same rock MA and  $M_{DE}$  are usually very similar. So it is assumed that  $MA = M_{DE}$  and then Abrasion Number is calculated by formula:

$$N_A = LAA + 5 \times M_{DE} \quad (3)$$

Where:

$N_A$  – Abrasion Number, %;

LAA – Los Angeles Abrasion value, %;

$M_{DE}$  – micro-Deval value, %.

Lifespan symbolizing “Life” is replaced by symbol  $L_{G/B}$  because lifespan to ballast will be determined, when concrete sleepers are used. When concrete sleepers are used in construction, eqn (2) is adjusted using previously accepted coefficients of correction A, B, C and eqn (3):

$$L_{G/B} = A \times B \times C \times (106 \exp(8.08 - 0.0382 N_A))$$

$$L_{G/B} = A \times B \times C \times (10^6 \exp(8.08 - 0.0382 N_A)) \quad (4)$$

$$L_{G/B} = 1.029 \times (10^6 \exp(8.08 - 0.0382 \times (LAA + 5 \times M_{DE})))$$

Using eqns (3) and (4) it is possible to calculate prognostic ballast lifespan according to measured values of mechanical properties which is expressible by MGT.

#### 4 Prognostic calculations results' assessment of ballast aggregate lifespan

Prognostic lifespan calculations are performed assessing indicators of Los Angeles and micro-Deval. Therefore, the received results by these calculations is complex evaluation of crushed stone mixture (mineral materials) most important mechanical properties. Seeking to determine and evaluate mechanical properties of different origin crushed stone from different suppliers, the experimental research has been performed in a laboratory. Two dolomite and three granite crushed stone mixtures from three different suppliers were selected and researched. Crushed stone mixtures of dolomite were encoded D1 and D2. Granite crushed stone mixtures have been encoded G1, G2 and G3. Abrasion Number  $N_A$  and prognostic lifespan of ballast aggregate  $L_{G/B}$  for researched materials in a laboratory are calculated according (3) and (4). Calculations' results are presented in Table 1.

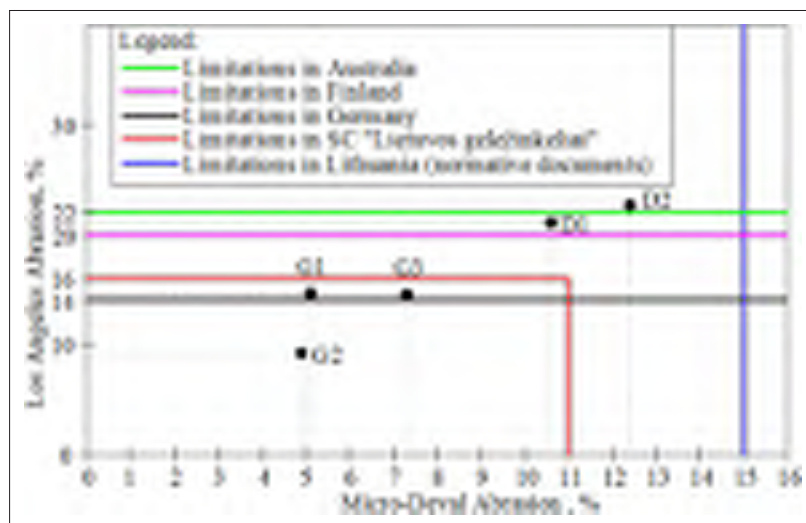
**Table 1** Prognostic calculations results of ballast aggregate lifespan

Material	Indicators, determined in laboratory		Calculated indicators	
	LA, %	$M_{DE}$ , %	$N_A$ , %	$L_{G/B}$ , MGT
D1	21,1	10,6	74,1	196
D2	22,7	12,4	84,7	131
G1	14,7	5,1	40,2	715
G2	9,2	4,9	33,7	917
G3	14,6	7,3	51,1	472

The determined results of particles resistance to wear and fragmentation and maximum permissible parameter values in Lithuania and another countries are given in Figure 1. It is seen that on the basis of existing regulatory documents in Lithuania the mentioned indicators of

all researched materials in laboratory are acceptable because maximum permissible limit of micro-Deval indicator is not exceeded, and Los Angeles Abrasion indicator is not rationed. After comparison of performed calculation results of crushed stone mixtures G2 and D2, it seen that, dependently on mechanical indicators, lifespan of different materials can even differ seven times. Despite this, it is prognosticated that dolomite crushed stone mixture D1 has possibility to hold out almost 200 MGT of traffic loads. These results show ballast aggregate lifespan under ideal operating conditions. It is accepted that there is no fouling out of blanketing sand, subgrade and another external sources.

Seeing that 76% of ballast fouling appear due to its own degradation [14], it is possible to reduce the prognostic lifespan of 200 MGT for 24% and approximately receive prognostic lifespan of 150 MGT. Calculated by analogy lifespan  $L_{G/B}$  of crushed granite mixture G2, 688 MGT is received. The latter parameter has already become closer to reality because there were 397 km of railway sections in 2015 where 595 MGT were transported through them at an average. Sections have been determined where more than 890 MGT (0, 9 km), 740 MGT (18, 3 km), and 690 MGT (42, 4 km) were transported through. Major repair has been delayed in all these sections. Intensive train traffic is in most of these sections, but road condition is good enough.



**Figure 1** Determination results of particles resistance to wear and fragmentation and maximum permissible values of these parameters in Lithuania and abroad.

However, it should be mentioned that ballast degradation due to ballast tamping, performed during the time maintenance or routine repair, is not evaluated. While tamping ballast, the ballast degrades much faster and real lifespan mostly depends on times of ballast tamping. Besides, ballast fouling from outside or fouling due to sub-soil penetration can change. For example, fouling from outside sources on station's roads can be significantly higher and penetration of sub-soils can be stopped using geotextile for equipment of subgrade. Concerning the latter reasons, it has been decided to do lifespan prognostic calculations assuming that operating conditions will be ideal.

Graphic lifespan prognostic model of ballast aggregate is given in Figure 2, which is further used as the basis for classification of Los Angeles and micro-Deval indicators. Parameters values of classified mechanical properties are divided into five categories, as it is submitted in Table 2. Restriction limits, suggested to every category, are inscribed considering to the maximum permissible parameter values that are presented in Figure 1.



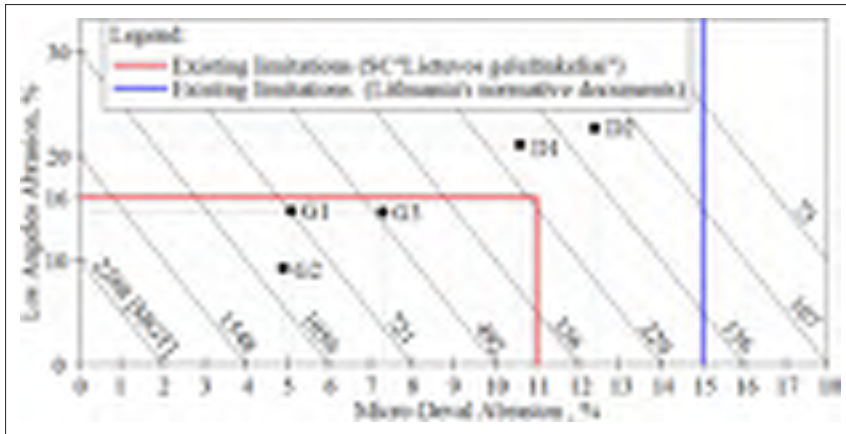


Figure 2 Lifespan prognostic graphic model of ballast aggregate as sleepers are made of concrete

Table 2 Division of ballast aggregate mechanical properties categories

Category of ballast mechanical properties	Category of the railway line	Annual traffic flow, MGT
K-1	GLK – Highway	–
	GLK – Intensive traffic	≥ 50
K-2	GLK-I	30 – 50
	GLK-II	8 – 30
K-3	GLK-III	
	K-4	GLK-IV
Another roads		2 – 8
K-5	Another roads	≤ 2

Rail access roads, local and connecting railway lines depend railway category “Another roads”, presented in Table 2. Highway rail lines for passenger trains to run from 160 km/h until 200 km/h are assigned to category K-1 of ballast mechanical properties.

## 5 Conclusions

Toughness and hardness of ballast aggregate particles directly influence residual life of ballast prism of the railroad. It is recommended to use such input parameters correction coefficients when the maximum permissible axle load is 25 t in Europe and concrete sleepers are used applying CPR model to determine lifespan:

- Measurement units:  $A = 1.102$ ;
- Axle load:  $B = 1.400$ ;
- Sleepers:  $C^{-1} = 0.667$ .

Two dolomite and three granite crushed stone tests' micro-Deval and Abrasion values have changed from 4,9 % to 12,4 % and satisfied the requirements of normative. Los Angeles Abrasion values have changed from 9,2 % to 22,7 %. However, the normative value for this indicator is not set. Toughness and hardness of the same origin rocks crushed stone are very different. The results show that LAA values of dolomite crushed stone mixtures differed 7,6 %,  $M_{DE}$  values differed 17 %. Granite crushed stone indicator values differed accordingly 59,8 %

and 49,0 %. The calculated Abrasion Number  $N_A$  differed 151,3 % and changed from 33,7 % (crushed granite) to 84,7 % (crushed dolomite).

The research has shown that when selecting ballast crushed stone it is necessary to evaluate not only the type of rock but also values of LAA and  $M_{DE}$  that directly influence Abrasion Number  $N_A$ .

## References

- [1] McDowell, G.R., Lim, W.L., Collop, A.C., Armitage, R., Thorn, N.H.: Comparison of ballast index tests for railway trackbeds, *Geotechnical Engineering*, vol. 157, no. GE3, pp. 151-161, 2004.
- [2] Bach, H.: Evaluation of attrition tests for railway ballast, Dissertation, Graz University of Technology, Institute for Railway Engineering and Transport Economy, 2013.
- [3] EN 1097-2:2010. Tests for mechanical and physical properties of aggregates – Part 2: Methods for the determination of resistance to fragmentation, Brussels, 2010.
- [4] Gaskin, P.N., Raymond, G.P.: Contribution to Selection of Railroad Ballast, *Journal of the Transportation Engineering Division, ESCE*, Vol. 102, No TE2, pp. 377-394, 1976.
- [5] McDowell, G.R., Bolton, M.D.: On the micromechanics of crushable aggregates, *Géotechnique*, vol. 48, no. 5, pp. 667-679, 1998.
- [6] Raymond, G.P.: Research on Railroad Ballast Specification and Evaluation, *Track Design and Construction: Transportation Research Record*, 1006, pp. 1-8, 1985.
- [7] McIntyre, A., Plitt, L.R.: The Inter-Relationship Between Bond and Hardgrove Grindabilities. *Canadian Institute of Mining and Metallurgy Bulletin* 63, pp. 149-180, 1980.
- [8] EN 1097-1:2011. Tests for mechanical and physical properties of aggregates – Part 1: Determination of the resistance to wear (micro-Deval), Brussels, 2011.
- [9] Raymond, G.P., Diyaljee, V.A.: Railroad Ballast Ranking Classification, *Journal of Geotechnical Engineering Division, ASCE*, Vol. 105, No. GT 10, pp. 133-153, 1979.
- [10] Selig, E.T., Boucher, D.L.: Abrasion Tests for Railroad Ballast, *Geotechnical Testing Journal, GTJOD*, Vol. 13, No. 4, pp. 301-311, 1990.
- [11] ASTM D6928-10. Standard Test Method for Resistance of Coarse Aggregate to Degradation by Abrasion in the Micro-Deval Apparatus, ASTM International, PA, 2010.
- [12] Klassen, M.J., Clifton, A.W., Waters, B.R.: Track Evaluation and Ballast Performance Specifications, TRR, 1131, TRB, Washington, DC, pp. 35-44, 1987.
- [13] Esveld, C.: *Modern Railway Track*, Second edition, TU-Delft, 2001.
- [14] Selig, E.T., Waters, J.: *Track geotechnology and substructure management*, Derby, England, 1994.





## POSSIBILITIES OF ENERGY SAVINGS IN HOT-MIX ASPHALT PRODUCTION

Zdravko Cimbola<sup>1</sup>, Zlata Dolaček-Alduk<sup>2</sup>, Sanja Dimter<sup>2</sup>

<sup>1</sup> COLAS Hrvatska d.d. Varaždin, Croatia

<sup>2</sup> University of Osijek, Faculty of Civil Engineering Osijek, Croatia

### Abstract

The Energy development strategy of Republic of Croatia defines the efficient use of energy and maximum application of cost-effective measures, with the aim of reducing energy consumption. According Strategy, projections indicate that by the year of 2030 the world's energy consumption will increase by 50% compared to today's consumption, which implies the need for energy sustainability. Like other industries, the production of hot mix asphalt (HMA) in the asphalt plant requires a considerable amount of energy. HMA production involves significant consumption of thermal energy as well as an adverse effect on the environment.

Operating mode of existing asphalt plants in the Republic of Croatia involves substantial energy consumption for drying and warming of chippings in the rotary drum. Combustion of gas, fuel oil or other energy sources, mineral mixture is dried and heated to the required temperature. Increasing of moisture content into the mineral mixture can significant increase required temperature for drying and warming, and thus can increased consumption of energy. Analysis of current situation in the asphalt plants was found that segment of conversion and using energy still do not use technical and technological innovations in the field. Moisture of aggregates and lack of regulated and covered landfills conducted in the minimum inclination, for outflow of drainage water, the problem is almost all asphalt plants in Croatia. The paper analyses the contribution of mineral mixtures dehumidification in reducing energy consumption and the possibility of using exhaust gas energy in the production process of asphalt mixture.

*Keywords: HMA production process, energy efficiency, utilizable energy potential, exhaust gas flow, moisture content of aggregates*

### 1 Introduction

The Republic of Croatia, like other countries, is facing with the challenges arising from climate change, increasing energy consumption, costs and very strict environmental requirements for the preservation of the surrounding soil, air and water. The adoption of the document The Energy development strategy of Republic of Croatia in 2009, Croatia has undertaken for the efficient use of energy and maximum application of cost-effective energy efficiency measures, with the aim of reducing energy consumption. According to the Strategy [1], the industrial sector contribute to the total final energy consumption more than 20%, with a slight, but steady increase in energy consumption in recent years (Table 1).

**Table 1** Energy consumption by all sectors [1]

sector	2006.	2015.	2020.	2030.
Industry	58.86	75.82	84.43	103.09
Transport	85.63	124.51	135.22	152.59
Other sectors	123.40	162.42	189.95	245.16
Total (PJ)	267.89	362.75	409.60	500.84

Analysis of current situation was found that segment of conversion and using energy (including construction industry) still don't use technical and technological innovations in the field. Current attention in the production of asphalt mixes in asphalt plants focuses on the asphalt production without thinking about possible improvements or cost savings in the production process. Asphalt production involves significant consumption of energy for drying and heating aggregate. Depending on mineral material moisture specific heat requirement per metric ton of asphalt mixed is between 70 kWh to 100 kWh [2]. These energy costs constitute significant percentage of the total cost of asphalt mixture production.

**Table 2** Final energy consumption by industrial sector [3]

Sector	2009.	2010.	2011.	2012.	2013.	2014.
Iron and Steel Industry	2.34	2.67	2.56	1.65	2.06	2.12
Non-Ferrous Metals Industry	0.55	0.47	0.59	0.63	0.63	0.58
Non-Metallic Minerals Industry	2.37	2.42	2.38	2.15	2.15	2.13
Chemical Industry	9.20	8.55	7.92	5.34	5.33	5.54
Construction Materials Industry	<b>16.35</b>	<b>15.09</b>	<b>13.11</b>	<b>12.15</b>	<b>12.79</b>	<b>12.52</b>
Pulp and Paper Industry	2.77	3.04	2.77	2.68	1.74	1.63
Food Industry	9.46	9.95	9.67	9.11	8.56	8.58
Other Manufacturing Industries	8.10	8.11	7.96	7.86	7.68	7.53
<b>Total INDUSTRY (PJ)</b>	51.14	50.30	46.96	41.56	40.92	40.63

An increasing interest in assessment of energy consumption through production processes in different industry sectors shows potential in the field of reducing consumption using waste heat or exhaust gases to reduce load on fuel consumption, Table 2. This paper describes the analysis of the asphalt production process in asphalt plants, the current energy efficiency of asphalt plants and possibility of improvement.

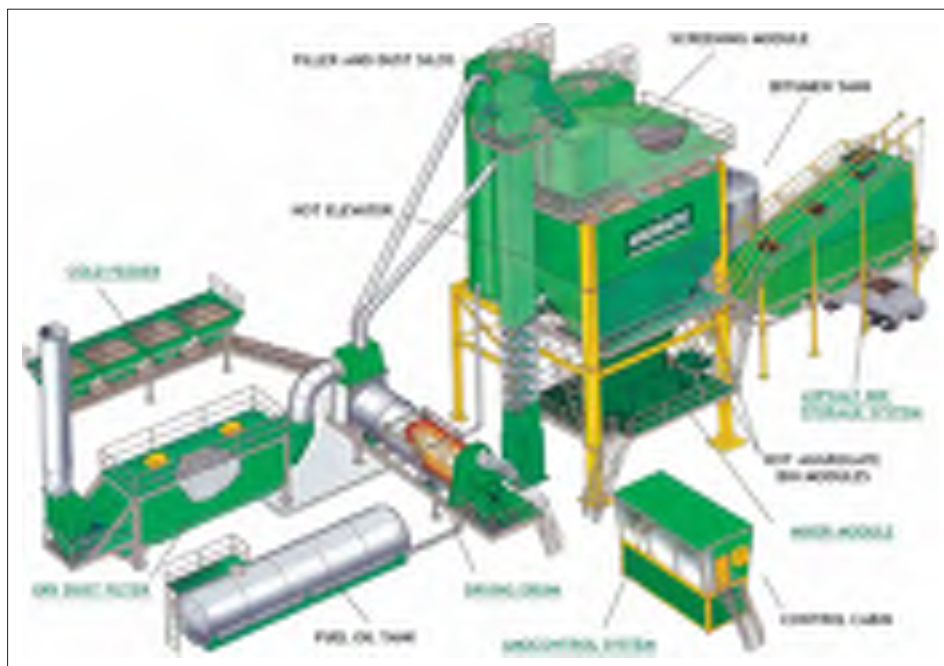
## 2 Production of Hot Mix Asphalt (HMA)

### 2.1 General

Hot mix asphalt (HMA) is a composite material, whose major components are the aggregates (sand and coarse aggregates), the filler and the bitumen. Asphalt mixes can also contain different kinds of additives to improve the performance of mixes, such as adhesion agents, modifiers or fibers. The graded aggregates constitute almost 90% in mass of the mixes. The matrix consist of a mastic composed by bitumen, the filler and (sometimes) additives, where the bitumen is the 5% of the mixes and the filler the remaining 5%.

Currently, in the Republic of Croatia asphalt mix produces at about 56 asphalt plants [2]. Total monthly production possible with the existing capacity is about 1.6 million tons of asphalt mixes. Five asphalt plant capacities are greater than 200 t/h, fifteen plants are capacity of 150-200 t/h, and thirteen plants are capacity of 100 to 150 t/h, while the other plants are with

a capacity of 100 t/h (six less 50 t/h). During 2015, all Croatian asphalt plants produced a total of 2.15 million tons of asphalt mixtures for the construction and maintenance of roads [2]. Technological processes, performed on a discontinuous asphalt plant, can be carried out differently. Phase of asphalt production can be divided into the following operations: (1) pre-dosing of stone fractions; (2) drying and heating the mineral mixture; (3) dusting muddy dusty particles from the mineral mixture; (4) sifting hot mineral mixture; (5) weight or volumetric dosing fractions of mineral mixture; (6) dosing of bitumen; (7) mixing the heated mineral mixture with the binder; (8) storing of hot asphalt mix and transport (Figure 1).



**Figure 1** Production of HMA in the asphalt plant [4]

For pre-dosing fraction of chippings and sand pre-dosers are used: series of 4 to 5 containers with holes in the bottom with a mechanism for releasing the mineral material. Drying and warming mineral mixture is performed in a rotary drum dryer. The drum has a burner, which throws intense flames by almost the entire length of the drum. Rotating the drum, with the help of internal spiral blade, stone mixture rises and from the highest point discharges through the flames. Every particle of stone mixture passes several times through the flame so it can be thoroughly dried and warmed. De-dusting small, dusty particles of stone mixture is carried out in the dust collection unit, consisting of a strong fan and collector. Dried, de-dusted and heated mineral mixture from the rotary drum with elevator transmitted to the central part of the asphalt plant where is screened in two, three or more fractions. Then mineral mixture is weighed and discharged into the mixer. The unheated filler is added into the mixer and mixed with chippings about 5 seconds. Finally, into the mixer is added the heated bitumen and stir until it reaches wrapped of complete stone parts. Temperature of asphalt mixture depends on the temperatures of stone chips, bitumen and filler and can affect on the quality of produced asphalt mix or the possibility of its application. Asphalt mixture temperature must be, for these reasons, strictly controlled during the production process. After mixing, asphalt mix will be unloaded into the truck or stored in the storage silos for short time.

## 2.2 Critical spots in the HMA production

Current operation of existing asphalt plants in Croatia means insufficient utilization of production capacity and substantial consumption of energy caused by the volatile production of asphalt mixes and use of cold and wet stone fractions. At the time of increasingly stringent environmental requirements, as well as striving to realize significant savings of energy in industrial processes, with analysis of existing asphalt production can be notice more critical places. The critical places consume more energy than needed and produced energy is irretrievably lost:

- 1) Pre-dosers; dosered the cold and wet stone fractions – consumption of energy due to drying and heating is highly dependent on precipitation and ambient temperatures;
- 2) Rotary drum for drying and heating mineral aggregate; combustion of gas, fuel oil or other energy mineral mixture is dried and heated to the required temperature. Due to the use of mineral mixture with a higher moisture content leads to reduction of the material flow as well as the realization of lower working capacity of asphalt plants;
- 3) Containers for stored bitumen; due discontinuous work (the production of asphalt mixes), insufficient utilization of asphalt plants, consume large amounts of energy to maintain the operating temperature of stored bitumen (at certain times of bitumen is heated, without any production);
- 4) Chimney for exhaust gas; due to the work of asphalt plants in the ambient air is discharged significant amounts of heat energy. Exhaust gas flow contain significant energy potential.

## 3 Utilization of energy potential in the HMA production

Researches related to energy analysis during the asphalt production and opportunities for energy conservation and costs are in focus for many years. Ang et.al. [5] formulated thesis that the aggregate moisture is main factor influencing the level of energy consumption in the HMA production process. They measured the aggregate moisture located on the storage of two asphalt mixing plant and determinate the implied upper moisture limits of field aggregate. Authors also concluded the short atmospheric falls lead to an important increase of the aggregate moisture. They found that reduction in aggregate moisture of 3% reduces energy consumption in drying by 55-60%.

Research conducted by Jenny [6] shown with a reduced mixing temperature from 165°C to 115°C and reduced aggregate moisture content from 4% to 2% the energy savings are approx. 2.5 kg of fuel per ton of asphalt. Author also concluded the work process concept reduces the moisture content of aggregates to less than 2% and this reduction leads to energy saving of 1,5 kg of heating oil per ton of asphalt.

**Table 3** Energy savings from reduced aggregate moisture [7]

% moisture before change	% moisture after change								
	1.0	1.5	2.0	2.5	3.0	3.5	4.0	4.5	5.0
1.0	0%								
1.5	8%	0%							
2.0	15%	7%	0%						
2.5	21%	14%	7%	0%					
3.0	26%	19%	13%	6%	0%				
3.5	30%	24%	18%	12%	6%	0%			
4.0	34%	29%	23%	17%	11%	6%	0%		
4.5	38%	33%	27%	22%	16%	11%	5%	0%	
5.0	41%	36%	31%	26%	21%	15%	10%	5%	0%

National Asphalt Pavement Association (NAPA) [7] presented opportunities for energy conservation in the HMA production process addressing specific actions that represent the largest potential for energy savings. Reducing aggregate moisture content is possible to achieve by sloping, paving or covering the aggregates. Producers report energy savings up to 10% by insulating dryer shells or surfaces. Other proposed actions are reducing exit gas temperatures, reducing exit material temperatures, using alternative fuels, using more efficient hot-oil heater designs, employing more effective piping insulation, using more effective tank and silo insulation and using variable frequency drives in large motors. Possible energy savings from aggregate moisture content reduction are presented in Table 3.

Peinado et al. [8] analysed energy and exergy of a rotary dryer in HMA production in asphalt plant. The parametric study had shown great impact of HMA temperature and moisture on the energy requirements for producing of HMA, although the influence on the energetic efficiency was low.

Sivilevičius [9] concluded the required temperature of HMA production, thus energy consumption, depends not only on the moisture and on temperature of mineral materials, fuel quality but also depends on the structure of asphalt mixing plant.

Grabowski et al. [10], [11] analysed test and measurements results (in two time phases) of the energy consumption during HMA production. Results shown that reduction in overall aggregate moisture content of about 1% decreases the real oil consumption by about 18%. Also concluded the organizational changes in the work system of asphalt mixing plant may significantly influence the energy consumption in the HMA production without additional financial costs.

Androjić [4] analysed share of moisture in mineral mixture and energy consumption and concluded that increase in the temperature of a mineral mixture results in reduced natural gas consumption per ton of asphalt mixture produced. Based on boundary temperature curves the removal of 1% of moisture in mineral mixture resulted in 13.13% to 4.51% energy savings for material heating.

In general, based on previous research results potential that occurs due to the production of HMA in asphalt plants is visible. Especially because of large amounts of unused energy created by heating a mineral mixture, which is released into the atmosphere in the form of exhaust gases.

## 4 The energy potential of exhaust gas

Linking the cycles into asphalt mix production would be possible to achieve savings in energy consumption and reduce amount of exhaust gas. Using part of the thermal energy from exhaust gases for heating mineral materials on dumps, moisture content of aggregates fractions will be reduce and, thus, time required for their preheating will be shorter.

The idea is to remove part of the moisture from the composition of mineral mixture using exhaust gas in the drying process. As part of the preliminary research stone material on a conveyor belt was exposed to convection drying taking into account air temperature, air velocity, belt speed, material layer thickness and drying time. For the experimental part of the project a laboratory device was structured consisting of drive fan unit / drying chamber with hot air, a device for measuring the mass of samples and devices for measuring the temperature of the samples.

The speed of the conveyor belt allows exposure of the stone material to heat hot air for 30, 45 and 60 seconds. The temperature of the hot air was constant during each measurement simulate the conditions of heating hot air exhaust gas temperature by taking into account the thermal losses incurred by supplying exhaust gas to the conveyor belt. Measurements are provided for three air temperature achieved during experiment 33.1°C, 50.4°C and 71.7°C. First results show the energy potential of exhaust gas during the short-term drying process (Figure 2).



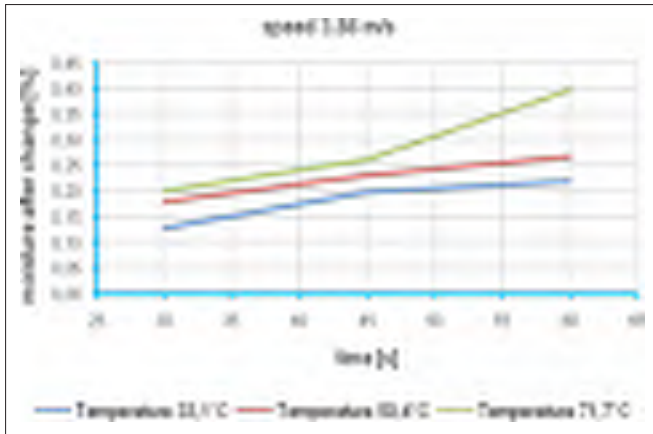


Figure 2 Preliminary results for aggregate moisture reduction

## 5 Conclusion

Production of construction material is energy demanding connected with present environmental issues. Hot-mix asphalt production is no exception. For many years, asphalt industry tries to find the balance between dynamic fuel market and possibilities to improve production process to reduce costs provided by technology development. The development progress relies on careful assessment of production process in order to find every possibility to contribute to the energy conservation. Many interventions have managed to rationalize energy consumption, but the today's challenge is to go further on developing the production process more environmentally friendly and energy acceptable. Proposed research and preliminary results are contribution to establish the model that describes the relationship of moisture content and temperature of mineral mixtures according to the temperature of hot air and the duration of short-term drying process. Proposed model could allow optimization of the technological process of production of asphalt mix and contribute to the implementation of technical innovations in hot-mix asphalt production.

## References

- [1] Strategija energetskeg razvoja Republike Hrvatske, NN 130/09 (in Croatian)
- [2] <http://www.h-a-d.hr> (in Croatian), accessed May 8, 2016
- [3] Ministarstvo gospodarstva, Energija u Hrvatskoj 2014., Zagreb, 2015.
- [4] Androjić, A.: Model optimalizacije utroška energenata u procesu proizvodnje vrućih asfaltnih mješavina na asfaltnim postrojenjima cikličnog tipa, disertacija, Građevinski fakultet Osijek, p244. 2013. (in Croatian)
- [5] Ang, B.W., Fwa, T.F., Ng, T.T.: Analysis of Process Energy Use of Asphalt-Mixing Plants, *Energy* 18(7):769-777. 1993. Doi:10.1016/0360-5442(93)90035-C
- [6] Jenny, R., CO<sub>2</sub> Reduction on Asphalt Mixing Plants. Potential and Practical Solutions, Australian Asphalt Paving Association (AAPA) thirteenth international flexible pavements conference, Queensland, Australia 2009.
- [7] Young, T.J.: Energy conservation in Hot-Mix Asphalt Production, NAPA Building, 2007
- [8] Peinado, D., de Vega, M., Garcia-Hernando, N., Marugan-Cruz, C.: Energy and exergy analysis in an asphalt plant's rotary dryer, *Applied Thermal Engineering*, 31 (2011) 6-7, pp. 1039-1049.

- [9] Sivilevičius, H.: Application of Expert Evaluation Method to Determine the Importance of Operating Asphalt Mixing Plant Quality Criteria and Rank Correlation, *The Baltic Journal of Road and Bridge Engineering* 6(1):48-58, 2011. Doi:10.3846/bjrbe.2011.07
- [10] Grabowski, W., Wilanowicz, J., Slowik, M., Sobol, T.: The assessment of the stiffening properties of mineral fillers obtained from a dust extractor installed in an asphalt plant, *Foundations of Civil and Environmental Engineering*, 10:25-38, 2007.
- [11] Grabowski, W., Janowski, L., Wilanowicz, J.: Problems of energy reduction during the hot-mix asphalt production, *The Baltic Journal of Road and Bridge Engineering*, 8(1): 40-47, 2013. doi:10.3846/bjrbe.2013.06





## MAIN WORKS FOR CONSTRUCTION OF RAILWAY BYPASS AROUND NIŠ

Tatjana Simić

CeS COWI d.o.o., Serbia

### Abstract

Railway bypass around the city of Nis represents the first phase of a long-term solution for modernization of Nis junction. By the preparation of the project documentation and then construction of the railway line, all non-conformities will be solved during the urban and demographic development of the city of Nis with investment in the road and railway infrastructure. Important questions which were solved during the design phase by active collaboration with the Beneficiaries were following: fitting of the bypass line to the five existing railway lines, fitting into the three existing stations (Niš Marshalling, Crveni Krst and Sićevo), construction of new establishment (stations: Niš Sever, Pantelej, Vrežina and temporary establishment – junction Prosek) and works on the adjustment between new and existing infrastructure. Designer's approach and proposal of the operational plan for construction of railway bypass with road traffic safety during the works are the subject of this title.

*Keywords: railway bypass, operational plan, construction, works*

### 1 Introduction

Finalization of the General Transport Master Plan in Serbia until 2027 with the National Strategy for Economic Development of Serbia will provide investments in transport corridors in order to integrate the transport system of Serbia into the European system. In that way conditions for effective participation of Serbian economy in the European market will be created. Geographical position of Serbia is of great importance in the formation of traffic flows as it lies on the main routes linking the countries of Western and Central Europe with the countries of South-East and the Middle East that is both comparative advantage and interest in ensuring the efficient flow of people and goods. Construction of railway bypass around Niš and its connection with existing railway lines in the country and abroad (to Belgrade and towards Skopje and Sofia), as well as the electrification of Niš – Dimitrovgrad will enable the association with TEN-T network.

### 2 The current state of infrastructure in the corridor of railway bypass

In relation to the international railway network (Figure 1), Niš represents the point of separation or merger of two main lines of international E-75 Budapest – Subotica – Belgrade – Nis – Skopje – Athens and E-70 in Paris – Turin – Sežana – Ljubljana – Zagreb – Belgrade – Nis – Sofia. Railway Trupale – Niš Ranžirna – Međurovo and Crveni Krst – Niš Ranžirna are also the main lines and railway Crveni Krst – Zajecar – Prahovo Port is regional railway according to the Regulation on the classification of railways art. 6 para.2 Railway Law (Official Gazette of RS, No. 45/13) and art.42 paragraph 1 of the Law on Government (PG RS No.55/05 and 71/05 – correction 101/07, 65/08, 16/11, 68 / 12 – U.S. and 72/12).



**Figure 1** Railway Network in Republic of Serbia

The existing established places are shown below:

- **Niš Marshalling yard** – Station is located west of the city of Nis, between the village Popovac and airport Constantine the Great. It is oriented in direction north – south, with the tracks divided into four groups:
  - Arrival-departure
  - Transit
  - Marshalling – departure
  - Station

Apart from these groups of tracks, the station Niš Ranžirna station consists of a locomotive depot and wagon workshop with an additional equipment.

- **Crveni Krst** – Station is located in the industrial zone of the city of Nis, outside the central zone of the city. Passenger, freight and local freight work is carried out here and it has a functional connection to the depot and industry.
- **Pantelej** – Halt belongs to the open line of the railway route to Matejevac. The halt is in a curve with the existing low platform. It serves for local passenger's traffic.
- **Prosek** – Halt belongs to the open line to Dimitrovgrad after the highway goes to station Sićevo.
- **Sićevo** – Station is located in Sićevo Gorge between Nišava and the main road Niš – Dimitrovgrad. Until 2009 there were three tracks that were dismantled. Station is in operation, there is a station building and a warehouse with warehouse ramp.

The year of building railway lines and existing Railway Network are shown in Figure 2.



Figure 2 Existing state of railway line in Niš

From the aspect of the road traffic, Niš is the crossroads of international regional and local road traffic. Sections of the international road E-75 (M-1) and E-80 (M-1.12) are the backbone of the bypass roads around Niš. The construction of the highway E-80<sup>th</sup> is in progress. From Niš are separating 11 routes on which bus transportation is organized.

From the aspect of air traffic, the city airport “Konstantin Veliki” is qualified for receiving medium aircrafts. “Konstantin Veliki” is the second category airport, and it is airport for regular and charter flights for the passengers of Niš and the region, and it serves as an alternative airport to Belgrade, Skopje and Sofia. Using of the runway is limited by the existing electrified railway.

### 3 Modernization – railway bypass around Niš

#### 3.1 Alignment

The alignment of the single-track railway bypass is designed with a length of 22.4 km, with a starting point in the Niš Ranžirna station. Editing of the existing route Niš Ranžirna – Crveni Krst, which was taken over bypass railway line, is carried out in order to meet the requirements of Niš airport (providing the space for the extension of the take-off and landing track and also the space for lighting of airport Konstantin Veliki). Reconstruction of the entrance Nis Ranžirna station is completed. Further, the new route guided by rim of the village Popovac until the new Niš Sever station. In this part of the route, bypass lines are largely in the cut corresponding to the request of the general visibility of the international airport in the area of take-off and landing tracks.

Niš Sever station on km 3+000 is located on the north side of the city of Niš. The station is designed along its length in the horizontal direction and in accordance with the traffic-technological requirements, taking into account the territorial limitations. The total length of the station is 1542 m. For the execution of all technological tasks, the final solution for the space of double track railway bypass, the station Niš Sever is designed with 7 tracks and 2 platforms. The first phase of the construction of the Niš Sever station includes the construction of 4 tracks, station building, plateau, access road and parking, underpass and platform no. 2. In the new station building are envisaged rooms for the signalling and interlocking devices, telecommunication devices and power devices.

The open line of the bypass from exit of Niš Sever station in the direction of the village Pantelej is projected. From km 5+270 to km 6+898 (entrance to the Pantelej station), bypass line is largely in the embankment with the elements of layout, and it is designed for speed  $v = 120$  km/h in accordance to current field possibilities.

The topography of the terrain, interoperability requirements, the technological requirement for work in the station all give input for defining length of the Pantelej station (1855 m). In traffic terms, it is an interstation and it regulates train traffic on the lines of Niš – Dimitrovgrad – border and (Niš) – Crveni Krst – Zaječar – Prahovo or onto the bypass line. The station Pantelej performs separation of the directions Dimitrovgrad and Zaječar and it is open for operation in passenger suburban, local and city traffic. The entrance of Pantelej station is designed in embankment, the exit is designed in the cut with retaining walls on the side of the both railway line to be aligned to existing settlement.

The alignment of the railway bypass from the exit of Pantelej station (km 8 + 753) to km 18 + 331 (near the junction Prosek) is designed with elements of the plan for the speed  $v = 160$  km/h. The Radius of the designed curve is  $R = 2000$  with transitions.

Vrežina station is designed on the km 14 + 600, so as to be open for operating in the passenger suburban, local and city traffic, but not to work for cargo traffic. Length of the station in the final stage is 1319 m. The first phase of the construction of the Vrežina station includes the construction of two tracks, station building on two levels with rooms that are adapted to the technological requirements, plateau, access road and parking, underpass and platform No. 1. Tracks constructed in the first phase of the official Vrežina site will be assigned function of the junction point.

The alignment is designed from the exit of the Vrežina station to the Prosek junction with the River Nišava, in order to avoid keeping the route through the hill. Concerning the sub-section, the technical solution with retaining walls (a distance of about 200 m) is adopted for the protection of the river Nišava, on one hand, and on the other because of the cuts in the hill. At the same time on that subsection, the designed elements of the plan correspond to the speed  $v = 120$  km/h and match the existing railroad Niš – Dimitrovgrad speed of 80 km/h. Prosek junction point is a temporary solution until the completion of construction and modernization of railway line number 22, and is designed in the km 19 + 304 bypass rail. In the new building, on the left side of the tracks, internal signalling and interlocking devices, telecommunications and power devices are located, and the access to the facility is provided temporarily from a state road.

At km 20+000 railway bypass fits into the reconstructed railway line Niš – Dimitrovgrad (km 14 + 258) in accordance with the Detail Design for the electrification of Niš – Dimitrovgrad and which goes to the Sićevo station (PS entry points) where is the end point of this Project. Railway bypass has influenced the existing tracks in the corridor, and they are reconstructed in accordance with the new alignment:

- 1) Subsection rail E70/85 Beograd-Mladenovac-Lapovo-Niš—Preševo – state border (Tabanovce) section Trupale – Niš Putnička – Medjurovo – main (line no.3) on the bypass rail corridor around the Niš is necessary to be reconstructed in the length of close to 4 km.
- 2) Subsection rail Trupale – Niš Ranžirna – Medjurovo – main (line no. 30) on corridor of bypass around Niša is necessary to be reconstructed in the length of close to 1,8 km.
- 3) Subsection rail Crveni Krst – Niš Ranžirna – Medjurovo – main (line no. 17) ) on corridor of bypass around Niša is necessary to be reconstructed in the length of close to 2.9 km, more precisely the existing railway route 17 from the station Niš Ranžirna (km 3+232 = PS 3) to the station Niš Sever the length of 1.7 km is dismantled.
- 4) Subsection rail Crveni Krst–Zaječar–Prahovo Pristanište – regional (line no. 38) on corridor of bypass around Niš is necessary to be reconstructed in the length of close to 4.5 km.
- 5) Subsection rail Niš – Dimitrovgrad – državna granica (Dragoman) (line no. 22) international main lines are necessary to be reconstructed in the length of 0.5 km on section at Prosek junction point.

Note All crossings with planned/existing roads are designed separate grade – underpasses and overpasses. Bridges, culverts, retaining walls, noise barriers are designed and they are contained in this Project.

## 3.2 Systems

**Power supply of catenary wire** of railway bypass track around Niš is provided from the existing electric traction substation (EVP) Niš. Based on preliminary electric estimation, it is necessary to increase the power EVP, and keeping in mind the age of the existing EVP Niš, a complete overhaul of the plant is planned. For integration of newly designed catenary wire of bypass track around Niš in the existing system of power supply and sectioning, the construction of facilities for sectioning PS Pantelej is planned. Electrification of this part will be finished in Vrežina station, where PS / PSN Vrežina will be built.

### Catenary wire

Catenary wire on newly designed railway bypass track around Niš is planned with chain-compensated contact line, composed of the contact wires and rope carrier. Contact line with “Y” wire is projected, which corresponds to the driving speed up to 160 km/h. Also planned are the support structures of catenary wire in two forms: cantilever poles from steel (U) profiles and grid steel structure portals.

One or both driving rails of each track in stations and both driving rails on open track are used as a returned line for traction current. The continuity of the return line of catenary wire is provided by the mutual electrical connection of neighbouring, non-welded rail fields using rail breakouts. To reduce voltage drop and equalizing the potential in return line, inter-rail and inter-track joiners between non-insulate rail is placed. Earthing of support structures of catenary wire is predicted with single connection on closer non-insulated rail. For longitudinal supply and sectioning of catenary wire, isolators with motor drives are planned, for the purposes of cross-sectioning in stations and isolators with manual drives.

### Remote control

An installation of new equipment for remote control of newly designed traction power plants in CRU Niš and in itself facilities is planned, as well as the replacement of the existing equipment. It is necessary to ensure sufficient capacity of transmission routes and compatible devices for transfer.

### Power supply of train station with electrical energy

In design of railway Niš Sever, Pantelej and Vrežina stations, a construction of one transformer station is planned, with 10/0,4kV adequate power and connecting lines 10kV. From this transformer station it is planned power supply of signalling – interlocking and telecommunication devices, external light and consumers in the station facility. Power of switches heater and backup power of signalling – interlocking and telecommunication devices, it is planned a construction of the new poles of transformer stations with 25/0,23kV adequate power, which is connected to overhead line of catenary wire. Plan is to relocate and protect all of the underground and over ground electro – energy lines, which are in collision with newly designed bypass rail route around city of Niš.

### Railway Signalling and Interlocking facilities and devices

Preliminary Design has processed the following things: way of ensuring the new and reconstruction of the existing railway stations and interstation distance in zone of Niš railway bypass, in accordance with the requirements defined in standard CENELEC EN 50126, EN 50128 and EN 50129 for work in system with electric traction of 25kV, 50 Hz; technical solution of equipment with signalling and interlocking devices for new stations, with HMI device and interstation distances ensured with devices for centralized automatic railway block, or interstation dependence, reconstruction of existing signalling and interlocking devices, and also installation of ETCS level 1 devices .



The equipping of the stations Sever Niš, Pantelej and Vrežina is designed with new interlocking equipment using the technique of electrical HMI control panel with the centralized setting switches and automatic reorganized routes plan through station area, as well as the elements of the European Train Control System (ETCS) level 1.

In accordance with the new arrangements of tracks in Niš Ranžirna station and the new interstation distances design solution in Niš Ranžirna station, dismantling, reparation and re-mounting existing systems is planned. The Centre of Telecommand for traffic also plans an alternation of panel and internal central device according with new track situation of railway junction and bypass Niš.

### Telecommunication facilities and devices

With construction Design of bypass railway, electrification of system 25 kV/50 Hz is planned, which means that a network for track and local cables must be built.

With regard to the requirement for transmission of information and the current state of technic, it is necessary to provide railway copper cables as well as fibre optic cables. The installation of fibre optic cables without metallic elements with single-mode fibre is also anticipated. Local cable networks should involve all participants in the regions of stations in the track telecommunication system.

Dispatching systems and track telephony should enable connection to the regulation of traffic and service connection. Radio dispatching system is designed on the basis of legal obligations that all tracks with speed greater than 100 km/h must be equipped with radio dispatching system.

In accordance with the expected needs of the Niš Sever, Pantelej and Vrežina station, platform (outgoing and incoming) information boards are planned. Planned sound system is designed for transmission of voice information about arrival and departure of trains. Planned for sound distribution of platforms are horn speakers which are mounted on poles or canopies at the height of about 4 m or on the facade of the building. Horn speaker and projectors for outdoor use are resistant to flame. The function of the video supervision system in the official places is to protect telecommunication equipment for informing passengers, placed outside the building and monitoring the movement of passengers along the platform. Central device of system for automatic fire alerts is anti-fire panel with single addressable loop, which connects detectors and modules inside the building. Central device is connected with an alarm telephone machine for the remote signalling of alarms and faults. The Central is set up in a dispatcher room.



Figure 3 New railway bypass alignment

## 4 Organization of construction works on bypass track and reconstruction of existing track

Proposal of construction is given under the assumption that the selected contractor will be able to make of parallelization of works in first phase, in order to shorten the construction period and enable the work railway and road traffic. In below are listed the main works, more precisely:

- Construction of the railway bypass (preparatory works, substructure with drainage, superstructure, structures, works on Catenary wire, Signalling and Interlocking and Telecommunication), facilities are planned for the observed section.
- Reconstruction of railway lines (largely due to changes in the route of the preparatory work, substructure with drainage, superstructure, works on Catenary wire, Signalling and Interlocking and Telecommunication), as well as the facilities which are scheduled on the observed section. On places of fitting reconstructed track in existing condition, it is necessary to include works of superstructure and catenary wire and also linkage of Signalization and interlocking systems)
- Road construction and deviations (substructure and superstructure of route)
- Construction of the station and complete infrastructure (track situation of superstructure, buildings, underpass platforms, installations)

Division in two phases is the result of the road and rail traffic on goings. Therefore, it is:

- 1) The first phase of works and its total length is submitted so that the traffic (road and rail) will be in function for as long as it is possible, while the construction works are taking place simultaneously in several points, which will, of course, depend on the availability of jeep on the field and contractor's machinery.
- 2) The other phases of the works on the subsections and the length of their work will be in accordance with the proposal of the traffic during the works.

### 4.1 Description of phases

#### I. Phase

Parallelization of works on the subsections that are completely independent. There are proposed subsections so that rail traffic functions undisturbed on the railway lines 3, 17, 30, 38 and 22.

- 1) Subsection 1 reconstruction of the track 3 (new route) Trupale – Niš Sever (chainages of track 3 – beginning of works at km 0+200 entrance in Niš Sever station km 1+500) in the length of 1300 m.
- 2) Bypass track of subsection 2 Niš Ranžirna – Niš Sever (chainages of bypass track from km 1+300 to Niš Sever station km 2+400) in the length of 1100 m
- 3) Niš Sever station subsection 3 (chainages of bypass track from km 2+400 to km 3+500) with works to protect the current collector and other installations (part of the station that is in the corridor lines 3 and 17 work in the phase II because of the traffic)
- 4) Bypass track – Subsection 4 (bypass chainages from km 4+450 to km 5+000 ) which includes a new object
- 5) Pantelej station – Subsection 5 (chainages of bypass track from km 6+700 to km 7+400) new railway line is higher than the current – EMBANKMENT – station building and access to the previously done access road as it is scheduled in the plan of the city of Niš. Subsection 6 (chainages of bypass track km 8+650 (behind of retaining wall) to km 9+400) new railway line 38 will be done in length 700 m in the same corridor of railway bypass around Niš and facilities under those subsections.
- 6) Construction of the bypass rail subsection 7 from km 9+400 all the way to Prosek to km 19+100 together with Vrežina station, facilities that are provided, in Vrežina station pay

attention to the protection of power transmission line, in part near the Nišava river take into account the work which needs to be done on the retaining walls and coastal fortification in a distance of about 200 m)

- 7) Prosek subsection 8 includes the following works of construction:
- 100 m track (reconstruction of track 22 outside the profile of existing lines 22)
  - bypass track from km 19+450 to 19+750
  - deviation / a temporary road in the length of 150 m
  - the access road from traffic roundabout to Prosek urban area in length of 800 m
  - traffic roundabout south with facility, overpass and part of the road up to the integration into the roundabout Sever.
  - roundabout Sever could be done by half without the suspension of road transport

**Note:** During the first phase all tracks and road traffic operate.

## II. Phase

Rail traffic is diverted from the track 3 to track 30, the traffic on the track 17 is abolished the scope of the construction work on subsection 9 Niš Sever – integration to Crveni Krst:

- completion of the Niš Sever station from 3+500 to 3+870 by track situation
- bypass track from km 3+870 to 4+450
- reconstruction of the track no. 3 with the length of 850 m
- reconstruction of the track 17 with the length of 850 m
- production of the retaining walls and buildings
- integration into the existing condition in Trupale and Crveni Krst direction, track 3
- integration into the existing condition in Crveni Krst direction, track 17

## III. Phase

Rail traffic is diverted from the track 30 and goes on new track 3 (reconstructed in the previous phases). The scope of the construction work of subsection 10 Niš Ranžirna – exit:

- Dismantling of the existing track 3, 30, 17
- Reconstruction of the Niš Ranžirna station,
- Reconstruction of the track 30 and matching with the existing condition to Trupale
- Reconstruction of the bypass track by km 1+300

## IV. Phase

Railway traffic – Track 38 in this phase must be closed. Subsection 11 Crveni Krst – Pantelej and the part of Pantelej station

- from km 5+000 to 6+700 of the bypass track and the reconstruction of the track 38 are in the same corridor – EMBANKMENT
- from km 7+400 to 8+650 (chainages at the bypass track) – bypass track and the reconstruction of the track 38 are in the same corridor – CUT – retaining walls

Material from the cut goes to the embankment, and for the construction of embankment materials from landfill are used, which was previously made in Pantelej station – phase I on km 6+800 (Excavation from Niš Sever). After this phase, Pantelej station will be completed and connected with track 38.

## V. phase

Railway traffic – In this phase track 22 must be closed. Subsection 12 from km 19+100 to 19+450- construction of bypass track. Two options are available at the junction point Prosek:

- the re-routing of road traffic
- closure of road

In both cases it is necessary to close the track 22. During the closure of the track, the works on Prosek junction point within 350 m of bypass track, temporary road crossing and road length of 200 m are performed. The integration is performed from km 20+000 in track 22. This means that the closure of the track may take a maximum range of 10-15 days.

## 5 Conclusion

Organization plan for construction depends on the phase project documentation – it will give overview of the time required for construction in accordance with the time schedule of activities proposed during the design. For the purposes of the dynamic plans preparation of in the form of Gantt chart, there are used structural-logical unified position of works. They are presented at the level as total and individually divided to the preparation, construction, electrical, architectural works and finishing works. Further, lower levels of activity with proposed duration of activities (according to experience) are also presented in Operational plan. This project is intended to be simultaneously engaged in two, and some of mentioned sub-section in a given time in three work brigades, both on the substructure and superstructure. According to the developed dynamic plan (Gantt chart), the total duration of work on the project is 700 working days.

Detailed technology of works, corrections on practical effects of machine and equipment, detailed Gantt chart of works will be prepared by the Contractor and accepted by the Investor, with special conditions for safe functioning of the railway and road traffic. After approval of that by the professional services and real needed time for realization of this project will be set.

## References

- [1] The European Agreement on Main International Railway Lines (AGS), European Agreement on Important International Combined Transport Lines and Related Installations (AGTC), the South East European Co-operation Process (SEEC) and the European Technical Specification for Interoperability (TSI)
- [2] Law on Railways (“Official Gazette of RS”, No 45/2013)
- [3] Law on Safety and interoperability of railways (“Official Gazette of RS”, No.104 / 2013)
- [4] Rulebook on the Designing, Reconstruction and Construction of certain elements of the Railway Infrastructure of some main Railway lines (“Off. Gazette of RS”, No.100 / 2012)
- [5] Law on Planning and Construction; Official Gazette of Serbia
- [6] Other technical regulations and standards for preparation of the project documentation for Modernization of Railways – Project documentation for the railway Bypass around Niš



## 11 RAIL TRACK STRUCTURE





## TRACK MAINTENANCE AT THE END OF LIFE CYCLE

Waldemar Alduk<sup>1</sup>, Saša Marenjak<sup>2</sup>

<sup>1</sup> HŽ Infrastruktura d.o.o. Zagreb, Croatia

<sup>2</sup> University of J.J. Strossmayer in Osijek, Faculty of Civil Engineering Osijek, Croatia

### Abstract

With determination of the railway track life cycle, time period of expected operation in satisfying the traffic needs for passenger and freight transport is also defined. During this period it is necessary to ensure expert maintenance activities. But what if expected life cycle is reached, but for some reason (usually budget constrains) it is not possible to start a new life cycle? More than 50% of railway network in Republic of Croatia is out of maintenance cycle. It means that average life cycle of track superstructure is overdue and it is no longer possible to ensure safe and reliable traffic within expected performances with regular maintenance activities which were anticipated during definition of the life cycle. In most cases infrastructure manager doesn't have a choice than to continue and adapt current maintenance activities and ensure safe and reliable railway traffic within constrains of approved budget. How to keep maintaining such track and which costs will be generated depends on conditions of track components and track geometry. Paper will address the issues of track maintenance for eastern part of lowland railway track R202 Varaždin – Dalj 130 km in length with superstructure 35 to 54 years old. This part of track is characterized with uniform track geometry and relatively small traffic demand and its superstructure can be divided in four characteristic types: joint track with wooden sleepers, continuously welded track (CWT) with wooden sleepers, CWT with concrete sleepers and direct elastic fastening (type ZEL) and CWT with concrete sleepers and non-elastic fastening (type K). Some proposals of adjusted maintenance of deteriorated track at the end of its life cycle will be presented.

*Keywords: track, additional maintenance, renewal, extended life cycle*

### 1 Introduction

With determination of the railway track life cycle, lifetime of expected track operation for passenger and freight transport is also defined in order to satisfy traffic demand. During relative long period of track operation it is necessary to ensure appropriate maintenance. However, what if expected life cycle of track is reached, but for some reason it is not possible to start a new life cycle? Key reasons for missing start of new life cycle are usually budget constraints. That makes infrastructure manager with no other choice than to keep on with maintenance in aim to ensure track reliability, availability and safety [1] within available budget.

It is a fact that more than 50% of railway tracks in Republic of Croatia is out of renewal – maintenance cycle [2]. This means the expected operative life track of track is overdue and it is no more possible to maintain a track in safe condition within expected performances with maintenance activities planned at the start of life cycle.



## 2 Maintenance in LC of railway track

Railway track, like any other system, has start of life cycle with its initial concept and end through disposal. With EN 60300-3-3:2004 Life cycle costing [3] any system can be defined through phases of initial concept, project, production, construction, operation and disposal. Main goal of track maintenance is to slow down the degradation of track quality during operation phase in order to ensure reliability, availability and safety.

Cycle “renewal – maintenance – renewal” is a classic systematic way of track maintenance [4]. After track construction follows a relative long time period of track operation for about 30-35 years. At the end of life cycle, track is usually seriously degraded, costs of maintenance are continuously rising and there is strong need for renewal. That usually means complete replacement of old superstructure with new one.

Alternative way of track maintenance is continuous maintenance, without renewal. It means permanent exchange of track components (deteriorated rails, sleepers, ballast) depending about degradation dynamics of track components. This way of track maintenance is not recommended [5], and it is only acceptable on lines with small traffic load, low operating speeds (up to 80 km/h) and in cases when infrastructure manager actually have no other choice.

## 3 Track condition at the end of life cycle on section Dalj – Pčelić

Today, main characteristic of railway infrastructure in Republic of Croatia is deterioration because of budget restrictions causing delays of planned renewals and need to implement speed restrictions in order to ensure safety of track operation. Such conditions unfortunately are also present on line R202 Varaždin – Dalj. It is regional line between northwest, northeast and central Croatia with mixed traffic. In last 15 years importance of this line is slowly decreasing.

**Table 1** Track data for line R202 Varaždin – Dalj, RJ HŽI Istok, NS Osijek

Track section	Vmax VR 2015/16 [km/h]	Renewal [year]	Age of section [years]	Length [m]	Section length – wooden sleepers [m]	Section length – concrete sleepers [m]	Wooden sleepers [units]	Average sleeper failure [%]	Max. sleeper failure [%]	Concrete sleepers [units]	Fastening type
1 Dalj – Osijek D. g.	40	1962	53	20072	20072	0	33453	17,43	33,97	0	TP/KD/SKL2
2 Osijek D.g. – Osijek	50	1962	53	2993	2993	0	4988	7,47	9,28	0	TP/KD
3 Osijek – Josipovac	80	1974	41	7936	7936	0	13227	15,67	29,16	0	KD
4 Josipovac – Bizovac	80	1974	41	11261	596	10665	993	15,67	29,16	17775	KD/ZEL
5 Bizovac – Koška	80	1975	40	13488	8241	5247	13735	19,44	37,45	8745	KD/ZEL
6 Koška – Našice	80	1976	39	15474	3143	12331	5238	2,48	4,88	20552	KD/KB
7 Našice – Đurđenovac	80	1981	34	9039	9039	0	15065	16,47	24,26	0	KD
8 Đurđenovac – Z. Orahovica	80	1981	34	9922	9922	0	16537	18,85	25,34	0	KD
9 Z. Orahovica – Čačinci	70	1981	34	5800	5800	0	9667	9,93	22,34	0	KD/SKL2
10 Čačinci – Slatina	70	1981	34	18420	18420	0	30700	7,47	24,56	0	KD/SKL2
11 Slatina – Cabuna	80	1978	37	11635	5337	6298	8895	12,40	24,64	10497	KB/KD
12 Cabuna – Pčelić	80	1978	37	5002	5002	0	8337	22,00	25,38	0	KD
<b>Total</b>				<b>131042</b>	<b>96501</b>	<b>34541</b>	<b>160835</b>			<b>57568</b>	

It is lowland line with mostly uniform geometry and possible speeds from 80 up to 140 km/h, with just a few curves where speed needs to be restricted. Last renewal was performed in period from 1962. to 1981. Infrastructure manager, HŽ Infrastruktura, RJ HŽI Istok, NS Osijek ensures and supervises maintenance of track section Dalj – Pčelić (131 km in length).

With last track renewal on section Osijek – Pčelić maximum speed was 100 km/h, but through time of operation, after expiration of expected life cycle and with increase of quality degradation it was necessary to implement speed restrictions [6].

In time period from renewal toward present day traffic load on this line is continuously decreasing from over 6 MBGT per year at the start of life cycle down to under 2 MBGT per year in 2015. Expected life cycle of this line was 33 years. Today track sections on this line are from 34 up to 54 years old. This means that life cycle of track is overdue and there is urgent need to implement, beside regular maintenance, additional maintenance activities.

## 4 Types of track on section Dalj – Pčelić

Every type of track is necessary to maintain with specific maintenance activities depending about track system and condition of track components. For rational accomplishment of maintenance activities, it is necessary to have some knowledge about expected duration of extended period of track operation up to date of prolonged renewal.

On lines where track renewal will happen in near future, it is only rational to perform minimal maintenance activities in correlation with speed restrictions on critical sections. If there are no plans for track renewal in foreseeable future, it is necessary to ensure additional maintenance activities in order to ensure track operation (in this case for 10 – 15 years).

According to available data, there are no plans for track renewal of line R202 Varaždin – Dalj in period 2016.-2020. [2]. In last decade continuous budget restrictions are affecting infrastructure manager, and considering decreasing importance of this line, renewal is not likely to happen in near future. Regular maintenance activities during life cycle of track in short mostly consists with replacement of track components, spot repairs, leveling-lining-tamping and weed control. On this line, at the end of track life cycle occurs a need for additional maintenance activities due to missing renewal of track.

### 4.1 Type 1: joint track

Joint track is present on track sections Dalj – Osijek Donji Grad and Osijek Donji Grad – Osijek, Fig. 1. Track system is wooden sleepers, rails type S45 and mixed types of fastening (screw spikes and K type). Weakest point of this track type are wooden sleepers due to old age (54 years).



Figure 1 Condition of track type 1

In last decade a limited maintenance activities were performed by NS Osijek in order to replace failed wooden sleepers (about 30% of all sleepers were replaced). Unfortunately, these maintenance activities were limited and insufficient due to budget constraints.

Because of very old age of wooden sleepers, number of defective sleepers on this track section is very high and in next period it is going to be even higher (expected life cycle of wooden sleeper is 30-35 years).

During regular maintenance activities on track sections it is necessary to perform additional maintenance activities – massive replacement of deteriorated wooden sleepers, replacement of wedged plates with ribbed plates, fastening type K only and with addition of ballast due to large works on sleepers replacement.

#### 4.2 Type 2: continuously welded track (CWT) with wooden sleepers

CWT with rail 49E1, wooden sleepers and K fastening is present completely on track sections Osijek – Josipovac, Našice – Slatina and Cabuna – Pčelić, and just partly on sections Josipovac – Našice and Slatina – Cabuna, Figure 2. Weakest points of this track system are also wooden sleepers due to increased age.



Figure 2 Condition of track type 2

During last decade within regular maintenance a significant number of wooden sleepers were exchanged with limited budget. On this sections wooden sleepers are 35 to 43 years old, and in following years number of defective sleepers is going to be even higher due to old age (expected LC of wooden sleeper in good ballast is 30-35 years).

With regular maintenance activities, at the end of expected life cycle of track it is also necessary to execute additional maintenance activities – massive replacement of deteriorated wooden sleepers and addition of ballast due to large works on sleeper exchange.

#### 4.3 Type 3: CWT with concrete sleepers and fastening ZEL.8

CWT with rail 49E1, concrete sleeper HŽ70 and elastic fastening ZEL.8 is partly present on sections Josipovac – Bizovac and Bizovac – Koška, Figure 3. Weakest point of this track system is poor condition of fastening.

Elastic direct fastening ZEL.8 is applied on concrete sleeper HŽ70 [7]. This type of fastening is without base plate, with visible degradation of clamp force due to degradation of rail pads and fastening pads, deformations on clamps, vertical screws and horizontal bars in sleeper body. Additional maintenance activities in this case includes partial replacement of ZEL.8 fastening with special new parts for UTZ fastening in combination with SKL-1 clamps for mounting on existing concrete sleepers HŽ70, Figure 4.



Figure 3 Condition of track type 3



Figure 4 Replacement of ZEL.8 fastening with compatible fastening UTZ

#### 4.4 Type 4: CWT with concrete sleepers and K fastening

CWT with concrete sleepers HŽ70 and K fastening is present on sections Koška – Našice and Slatina – Cabuna, Figure 5. All track components of this track system are so far in good condition. With regular maintenance performed though a life cycle, at the end of track life cycle there is no need for additional maintenance activities for this track system.



Figure 5 Condition of track type 4

## 5 Additional maintenance versus renewal

For each type of track constructions costs of additional maintenance are calculated. Additional maintenance activities need to be performed in period 3-5 years in order to ensure availability, reliability and safety of traffic for expected period 10 to 15 years. Calculated costs are based on unit prices of materials and unit prices of maintenance services (data provided by HŽ Infrastruktura, Zagreb, 2016.). With unit prices based on existing contracts, additional maintenance costs are calculated for each type of track (costs of operating hindrances were not included). Costs of additional maintenance are compared with costs of track renewal (with brand new track components: rails 49E1, concrete sleepers PB85K/SKL-1, ballast and sub ballast).

**Table 2** Additional maintenance costs versus costs of track renewal

Track type	Additional maintenance [kn/km]	Renewal [kn/km]	Add. maintenance/Renewal [%]
Type 1	722.000	3.644.212	19,81
Type 2	541.833	3.644.212	14,87
Type 3	440.000	3.644.212	12,07
Type 4	0	3.644.212	0,00

With presented 4 types of track systems, on this line so far type 4 has been most successful. Even after period of 40 years in operation, it is still compact and without significant signs of wear. In future it is expected to keep on with regular maintenance in correlation with actual traffic load. It is important to emphasize that costs of an additional maintenance does not exclude regular maintenance costs. Although additional maintenance costs are significantly lower than costs of renewal, they are just necessary alternative to ensure continuation of operation of traffic in safe manner and without speed restrictions. Described activities of additional maintenance cannot replace effects of track renewal. With track renewal life cycle will be linked with actual traffic load and actions of regular maintenance, with viable option for prolongation of life cycle without costs of additional maintenance.

## 6 Conclusion

Track types with wooden sleepers (type 1, type 2) have shown large demand for additional maintenance activities caused by limited durability of wooden sleepers. In a goal to ensure reliability, availability and safety of track operations at the end of its life cycle for additional period of 15 years, it is necessary to ensure costly activities of additional maintenance activities for sleeper exchange. Track type 3 with concrete sleepers and fastening system ZEL.8 at the end of life cycle has performed significantly better in comparison with track types with wooden sleepers (type 1, type 2), but not as good as type 4 (concrete sleepers, K fastening system) where additional maintenance activities are not needed at all. Future track renewals should be made with concrete sleepers only (or eventually synthetic sleepers) on all lines where possible (radii over 250 m, slope up to 15 ‰) where all components of sleeper (including fastening) are durable longer than expected life cycle of track. This will ensure expected life cycle of new track with regular maintenance depending on existing traffic load, but if need occurs, there would be an option for prolongation of track lifetime without significant additional maintenance activities and additional costs [8].

Renewal of line R202 Varaždin – Dalj on section Dalj – Pčelić is essential. Until conditions to ensure track renewal are present, it is necessary to adapt current track maintenance to actual track conditions with additional maintenance. When track renewal is about to be started, it is important to be performed depending on actual conditions on track sections. This means the line renewal should be first performed on track sections with wooden sleepers (type 1, type 2), and later, in following phase, on track sections with concrete sleepers (type 3, type 4).

## References

- [1] EN 50126:1999 Railway applications – The specification and demonstration of Reliability, Availability, Maintainability and Safety (RAMS)
- [2] Republic of Croatia, National program of railway infrastructure for period 2016. to 2020., NN 103/2015
- [3] EN 60300-3-3:2004 – Dependability management. Application guide. Life cycle costing.
- [4] Zoeteman, A.: Life cycle costs for managing railway infrastructure, Delft University of Technology, 2001
- [5] Trameo, Investment and maintenance strategies, Final report, Graz University of Technology, 2006
- [6] HŽ Infrastruktura (IM) database, RJ HŽI Istok, Nadzorno središte Osijek, 2016.
- [7] Božičević, J.: Prilog povećanju sigurnosti i brzine u tehnologiji i eksploataciji željeznica, Disertacija, Fakultet za pomorstvo i saobraćaj, Rijeka, 1983.
- [8] Alduk, W.: Održavanje u životnom ciklusu željezničke infrastrukture, magistarski rad, Građevinski fakultet Osijek, Osijek, 2013 (mentor: Marenjak, S.)





## ANALYSIS OF NEW SUPERSTRUCTURE COMPONENTS OF RAILWAY TRACK IN TUNNEL SOZINA IN MONTENEGRO

Zoran Krakutovski<sup>1</sup>, Darko Moslavac<sup>1</sup>, Zlatko Zafirovski<sup>1</sup>, Aleksandar Glavinov<sup>2</sup>

<sup>1</sup> University “Ss. Cyril and Methodius” – Faculty of Civil Engineering Skopje, Republic of Macedonia

<sup>2</sup> University “Goce Delcev” – Stip, Military academy “General Mihailo Apostolski” Skopje, Republic of Macedonia

### Abstract

The actual superstructure components of railway track in tunnel Sozina in Montenegro is with following materials: wooden sleepers, rail type 49, rigid fastening K system and crushed stone for ballast. The envisaged new railway superstructure should be completed with mono-block prestressed concrete sleepers, rail type 49E1, elastic fastening and crushed stone for ballast. The replacement of wooden sleepers with concrete sleepers and rigid with elastic fastening is the principal replace of superstructure components. This requirement is completed by the railway infrastructure company in Montenegro because the maintenance works of track are very important in the tunnel and the cross section of the tunnel allows usage of slippers with a length of 2.4 m. The influence of vertical track loads and of temperature changes on continuous welded track (CWT) is calculated for a new conception of track. The theoretical analysis under the influence of vertical loads on the track is carried out according to the Zimmerman and Eisenmann theoretical approach. The effect of axial forces from temperature changes are also calculated and added to the dynamic stresses in order to obtain the total stress in the rails, which were compared with a maximum allowable stresses. The effects of temperature changes, as well as crack of rails, are also considered. The stability of Continuous Welded Rails (CWR) on bulging under the impact of vertical or lateral forces is also verified.

*Keywords: railway superstructure, rails, sleepers, calculation of railway superstructure*

### 1 Introduction

The analyses of a new railway superstructure components concern the segment in tunnel Sozina on railway section Virpazar- Sutomore in Montenegro. The required modifications of superstructure design project refer to the replacement of wooden sleepers with concrete prestressed sleepers with length of 2.40 m and application of elastic fastening for fixing the rails to the sleepers, compatible with concrete sleepers. The calculations of superstructure elements are studied under influence of the vertical loads and also from the temperature changes on continuous welded track (CWT). The total length of tunnel is 6.170 km, and the total length of track where the new superstructure would be laid is 6.500 km. The layout on the exit of the tunnel is designed in curve with radius of 350 m.



## 2 Characteristics of materials in superstructure and subsoil used in analysis

According to the requirements of the Railway Infrastructure Company, the new conception of the superstructure includes the following components:

- Rail 49E1, Quality 260
- Mono block pre-stressed concrete sleeper, length  $L = 240\text{ cm}$
- Fastening type Vossloh – SKL 14
- Crushed stone for ballast and minimum thickness of 35cm below the lower surface of the sleepers.

Geometrical and physical characteristics of rails 49E1 are follows:

- Cross section of the rail 49E1,  $A_s = 62,92\text{ cm}^2$
- Weight of the rail 49E1,  $g = 49,39\text{ kg/m}$
- Moment of inertia of the rail 49E1,  $I_x = 1816\text{ cm}^4$
- Section modulus of the rail 49E1,  $W = 247,5\text{ cm}^3$

Geometrical and physical characteristics of mono block pre-stressed concrete sleeper are following:

- Weight (without fastening) 260 kg
- Length 2400 mm
- Width 300 mm
- Height of sleeper 234 mm (214 mm)
- Support surface 6237  $\text{cm}^2$
- Maximum speed 160 km/h
- Permissible axle load 25 t

The usage of crushed stone of silicate and eruptive rocks is envisaged concerning the quality of crushed stone ballast. The rocks which are particularly suitable for making crushed stone for ballast are following: diabase, granite, gabbro, syenite and quartz. The thickness of the ballast taken in the calculations is  $h = 35\text{ cm}$  below the sleepers. The allowable stresses at the contact surface of the sleeper-ballast are 0.30 MPa (or 0.30  $\text{N/mm}^2$ ).

The geotechnical investigation works along the section of the railway tunnel indicate that the quality of materials in the subsoil below ballast is good. According to these results, the track reaction modulus relates to the material classified as “good” (Table 1).

**Table 1** Admissible stresses in the subsoil

Classification of materials	Elasticity modulus of subsoil	Track reaction modulus	Admissible stress in subsoil after n number of loading cycles
	$E_{v_2}$ [ $\text{N/mm}^2$ ]	$C$ [ $\text{N/mm}^3$ ]	$\sigma_{adm}$ [ $\text{N/mm}^2$ ] $n = 2 \cdot 10^6$
Poor	10	0.03	0.011
	20	0.04	0.022
Fair	50	0.07	0.055
Good	80	0.09	0.089
	100	0.11	0.111

*Source: [1] Esveld C., 1989*

The calculations of the superstructure under the impact of vertical loads are carried out for good quality material with track reaction modulus of  $C = 93333\text{ kN/m}^3$  ( $0.093\text{ N/mm}^3$ ).

### 3 Analysis of the superstructure laded with vertical loads

#### 3.1 Theoretical context

The axle load for the calculation of the superstructure is adopted for railway lines category D4, with a maximum axle load of  $P = 250$  kN.

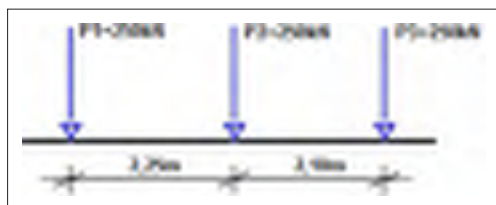


Figure 1 Vertical loads of track considered in analysis

The analysis of track is done according to the theory of Zimmerman. One rail with infinite length is analysed like elastic beam laid on continuous elastic supports. Another assumption in the analysis is that the track reaction modulus  $C$  is constant and the wheel load is simulated by a concentrated load  $P$ .

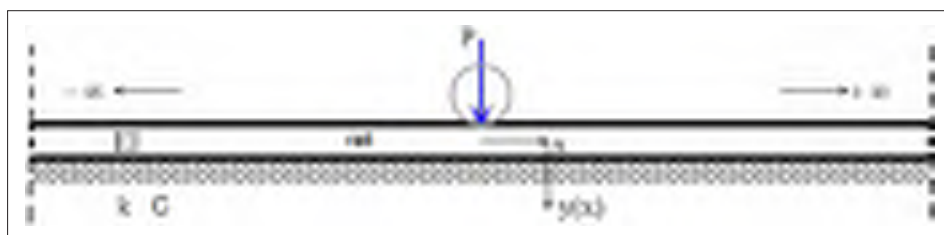


Figure 2 Analysis of rail according to the theory of Zimmerman

The Winkler hypothesis says that the normal stresses  $\sigma$  is proportional with the local deformation  $w$ , or more exactly:

$$\sigma = C \cdot w \quad (1)$$

$C$  – track reaction modulus [kN/m<sup>3</sup>]

$w$  – beam settlement [mm]

If we mark spacing between sleepers with  $a$ , the sleeper seating surface  $A$  (for half sleeper), then stiffness coefficient of the base  $k$  [kN/m<sup>2</sup>] will be:

$$k = \frac{C \cdot A}{a} \quad (2)$$

The assumption is that the beam has infinite length, with same cross section and with coefficient of bending stiffness  $EI$ . After elastic theory this problem could be solved with the differential equation of fourth degree:

$$E \cdot I \cdot w^{IV} + k \cdot w = 0 \quad (3)$$

The solution is:

$$w(x) = \frac{P \cdot L^3}{8 \cdot E \cdot I} \cdot \eta(x) = \frac{P}{2 \cdot k \cdot L} \cdot \eta(x) \quad (4)$$

In upper equation L is rail characteristic length defined with:

$$L = \sqrt[4]{\frac{4 \cdot E \cdot I}{k}} \quad (5)$$

In Eq.(4) the function  $\eta(x)$  appears which determine the deformation elastic line. It's form is:

$$\eta(x) = e^{-|x|/L} \cdot \left[ \cos \frac{x}{L} + \sin \frac{|x|}{L} \right] \quad (6)$$

The bending moments elastic line is defined by the function  $\mu(x)$  as follow:

$$\mu(x) = e^{-|x|/L} \cdot \left[ \cos \frac{x}{L} - \sin \frac{|x|}{L} \right] \quad (7)$$

The equation for calculation of bending moments for a beam on elastic support is:

$$M(x) = \frac{P \cdot L}{4} \cdot \mu(x) \quad (8)$$

The compressive stress on the foundation, according to Winkler is:

$$\sigma(x) = C \cdot w(x) = \frac{P \cdot a}{2 \cdot A \cdot L} \cdot \eta(x) \quad (9)$$

In reality several vertical concentrated forces act on the rail on the distances between them  $l_i$ , so it should make superposition of influences of all wheels:

$$w(0) = \frac{1}{2 \cdot k \cdot L} \cdot \sum_i P_i \cdot \eta_i(l_i) \quad (10)$$

$$\sigma(0) = C \cdot w(0) \quad (11)$$

$$M(0) = \frac{L}{4} \cdot \sum_i P_i \cdot \mu_i(l_i) \quad (12)$$

### 3.2 Stresses in the rail, sleepers, ballast bed and in the subgrade

The effect of additional dynamic loads of train for calculation of stresses corresponds with a model in Germany developed by Eisenmann for calculation of stresses in the rail including dynamic loads. The model is based on statistical observations and it takes into account train speed, material fatigue and track conditions. The biggest expected dynamic bending stress in the rail leg is:

$$\sigma_{\max} = \sigma_{st} \cdot (1 + t \cdot s) \quad (13)$$

$$\sigma_{st} = \frac{M}{W} = \frac{P \cdot L}{4 \cdot W} \quad (14)$$

Where  $W$  is section modulus of the rail ( $m^3$ )  $M$  is bending moment,  $P$  is vertical force, and  $L$  is characteristic length.  $t$  is increasing factor which depends from the confidence interval in the statistical analysis. It is recommended to adopted  $t = 3$ , and  $s$  is coefficient of variation.

$$s = 0,1 \cdot \phi - \text{for new rails} \quad (15)$$

$$s = 0,3 \cdot \phi - \text{for rails with fair quality} \quad (16)$$

$$\phi - \text{speed factor, } \phi = 1 \text{ for } V < 60 \text{ km/h} \quad (17)$$

$$\phi = 1 + \frac{V - 60}{140} \text{ for } V > 60 \text{ km/h} \quad (18)$$

In accordance with the existing Main Design for the rehabilitation of the railway line in the tunnel Sozina the speed limit is 70 km/h, which is taken into the calculations. The rails are under stresses with different nature: residual stresses as a result from rail manufacture, normal stresses due to temperature changes, bending stresses from wheel loads etc. The admissible bending stress must take into account all impacts on rails, and for a new rail 49E1, welded in CWT the admissible bending stress is 282 MPa. The sleepers are laid in the ballast bed and the maximum force which influences the sleeper could be calculated after Eisenmann as:

$$K_{max} = \frac{P \cdot a}{2 \cdot L} \cdot (1 + t \cdot s) \quad (19)$$

The compression stresses in the sleeper under rail pad are calculated as:

$$\sigma = 1 + \frac{K_{max} + F_0}{b \cdot B} \quad (20)$$

Where  $F_0$  is fastening force,  $b$  is rail leg (rail pad) width and  $B$  is sleeper width. The compressive stresses which sleepers transfer to the ballast are highest immediate under the sleeper. The maximum stresses in the ballast under the sleepers after Eisenmann are:

$$\sigma_{max} = \sigma_{sr} \cdot (1 + t \cdot s) \quad (21)$$

$$\sigma_{sr} = \frac{P \cdot a}{2 \cdot L \cdot A} = \sqrt[4]{\frac{C \cdot a^3}{4 \cdot E \cdot I \cdot A^3}} \quad (22)$$

Where  $P$  is wheel load,  $a$  is spacing between sleepers,  $L$  is characteristic length,  $A$  is sleeper resting area (for half sleeper), and  $C$  is track reaction modulus. When the load is acting on one sleeper, the stresses under the adjacent sleepers is:

$$\sigma_i = \sigma_{max} \cdot \eta(x_i) \quad (23)$$

The methods of Odemark and Brauning are used for calculation the maximum stresses from the ballast to the subsoil.

### 4 Analysis of the superstructure under influence of temperature changes on CWR

The maximum and minimum temperature changes in the rails are  $T_{max} = 65\text{ }^{\circ}\text{C}$  and  $T_{min} = -30\text{ }^{\circ}\text{C}$ . The neutral or laying temperature of rails is  $T_n = 22.5\text{ }^{\circ}\text{C}$ , and the maximum and minimum temperature changes are:

$$\Delta t_{max} = \Delta t_{summer} = t_{max} - t_n = 65 - 22.5 = 42.5\text{ }^{\circ}\text{C} \tag{24}$$

$$\Delta t_{min} = \Delta t_{winter} = t_{min} - t_n = -30 - 22.5 = -52.5\text{ }^{\circ}\text{C} \tag{25}$$

Longitudinal resistance of the ballast bed against track movement is non-linear function from the intensity of displacements and could be defined as:

In summer:  $\tau_s = 75 \cdot U^{0.25} \text{ [N/cm]} \tag{26}$

In winter:  $\tau_w = 150 \cdot U^{0.125} \text{ [N/cm]} \tag{27}$

For adopted maximum displacement of the track  $U_{max} = 0.5 \text{ cm}$ , linearization of the longitudinal resistance is calculated from the condition that area under the parabola is equal to the area of the triangle (Figure 3):

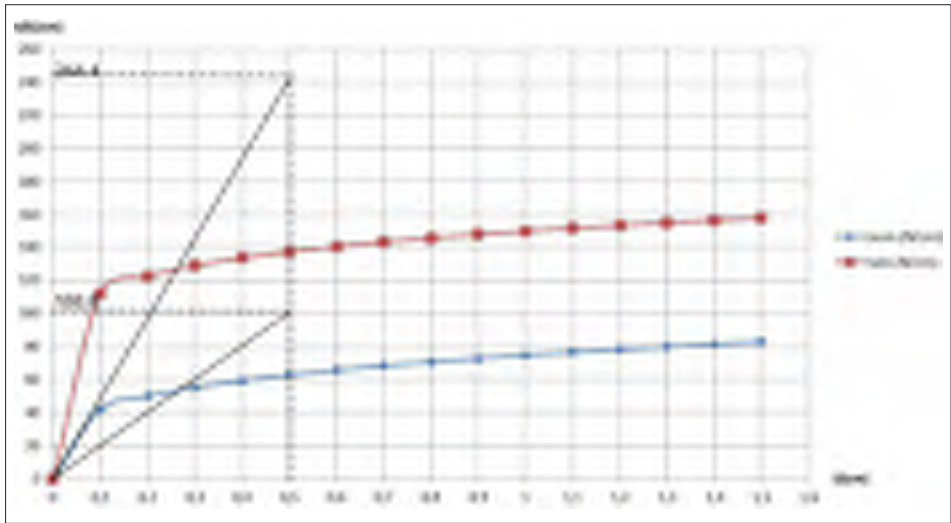


Figure 3 Longitudinal resistance of the ballast bed against track movement in summer and in winter

In summer:  $P = \int_0^{0.5} 75 \cdot U^{0.25} dU = 75 \int_0^{0.5} U^{0.25} dU = 25.2 \tag{28}$

$$\frac{\tau_s \cdot U}{2} = P \rightarrow \tau_s = \frac{2P}{U} = \frac{2 \cdot 25.2}{0.5} = 100.8 \text{ N/cm} \tag{29}$$

In winter:  $P = \int_0^{0.5} 150 \cdot U^{0.125} dU = 150 \int_0^{0.5} U^{0.125} dU = 61.1 \tag{30}$

$$\frac{\tau_w \cdot U}{2} = P \rightarrow \tau_w = \frac{2P}{U} = \frac{2 \cdot 61.1}{0.5} = 244.4 \text{ N/cm} \quad (31)$$

The rail stresses due to temperature changes, the stability of track from track buckling in horizontal and vertical direction are also analysed and considered.

## 5 Results from analysis of the superstructure

Calculation of superstructure begins with calculation of stress of a beam on elastic supports on which the track is loaded with axle load of  $P_{\max} = 25 \text{ t}$ . The dynamic additional loads are taken into account by increasing the static stress with dynamic coefficient, which is a function of the speed of trains. The rails are treated as a beam on elastic supports for which is calculated the stress from the static and dynamic effects (Zimmermann's theory).

The effect of axial forces from temperature changes are also calculated and added to the dynamic stresses in order to obtain the total stress in the rails, which were compared with a maximum admissible stresses. The effects of temperature changes, as well as the crack of rails, are also verified. The stability of Continuous Welded Rails (CWR) under the impact of vertical or lateral forces is also tested. The safety coefficient from track buckling in vertical direction is  $k = 1.54$ . This value is higher than the requested safety coefficient  $k = 1.2$  which means that the track is stable in the vertical plane. The summarized results of analysis are the following:

- Bending moment of the rail  $M_{\max} = 22.8 \text{ kNm}$
- Total bending stresses in the rail  $321 \text{ MPa} > 282 \text{ MPa}$  which are 14% higher than the admissible total stress. These stresses are calculated with a maximum axle load of 250 kN and extreme temperature differences on the open line. The control of stresses summarizes all stresses obtained with the maximum temperature changes. The temperature variations of the temperature of laying the rail are following: in summer  $42.5 \text{ }^\circ\text{C}$  and in winter  $-52.5 \text{ }^\circ\text{C}$ . These temperature differences are extreme temperatures on the open line. If the assumed minimum temperature in rail in the tunnel during winter is  $-15 \text{ }^\circ\text{C}$  and the maximum temperature in rail in the tunnel during summer is  $+30 \text{ }^\circ\text{C}$ , then the additional stresses in winter are  $66.4 \text{ MPa}$ . With these overall stresses the bending rails stress is  $255 \text{ MPa} < 282 \text{ MPa}$ .
- The maximum vertical force on the sleeper is  $K_{\max} = 63.8 \text{ kN}$
- Pressure from the sleeper to the ballast is  $\sigma_{\max,pr-z} = 0.236 \text{ N/mm}^2 < 0.300 \text{ N/mm}^2$
- Pressure from the ballast to the subsoil:  
 Method Odemark  $\sigma_{\max,z-pl} = 0.110 \text{ N/mm}^2 < \sigma_{adm.} = 0.111 \text{ N/mm}^2$   
 Method Brauming  $\sigma_{\max,z-pl} = 0.119 \text{ N/mm}^2 \approx \sigma_{adm.} = 0.111 \text{ N/mm}^2$

The calculation results for stability of tracks with concrete sleepers against displacement of track in a curve with a radius of 350 m indicate that it should incorporate "caps" to increase the lateral resistance track and it should be installed these devices on each third sleeper throughout the entire length of the curve. The critical lateral resistance of track without "caps" is  $9.25 \text{ kN/m}$ , which is higher than the critical lateral resistance of  $8.6 \text{ kN/m}$ . The track with "caps" devices has a lateral resistance of  $10.6 \text{ kN/m}$ ; it is superior to the critical lateral resistance.

## References

- [1] Esveld, C.: Modern Railway Track, Duisburg-Germany, 1989.
- [2] Eisenmann J.: Die Schiene als Tragbalken, Eisenbahningenieur 5/2004, 2004.
- [3] Profillidis, V.A.: Railway Management and Engineering, Third edition, Ashgate, USA, 2006
- [4] Rulebook 336 ZŽ concerning rails welding (last edition Beograd, 1986).
- [5] Rulebook 314 ZŽ concerning maintenance of railway superstructure (last edition Beograd, 1991).
- [6] Rulebook 315 JŽS concerning railway substructure (last edition Beograd, 1975).





## STABILITY CHART FOR CAVITY EXISTENCE BELOW RAILWAY TRACK

Yujin Lim<sup>1</sup>, JinWook Lee<sup>2</sup>, Hojin Lee<sup>1</sup>, Sang Hyun Lee<sup>1</sup>

<sup>1</sup> *PaiChai University, Korea*

<sup>2</sup> *Korea Railway Research Institute, Korea*

### Abstract

Cavities are found many times recently in downtown of metropolitan cities due to old and damaged pipes installed in the ground. The cavities are generated by spilling out of water from pipes mostly. The cavities generated below subway track can make irregularities and instability of the track. In this study, a finite element program ABAQUS is used to analyze the structural behavior of the track in cases of existence of cavities in subway trackbed foundation. It is found from the FE analysis that there can be a lot of differences in displacement of the track, depending on soil modulus, depth and diameter of cavity. The most important influence factors on the structural stability of track can be provided from the analysis in case of cavity existence in the trackbed foundation. Influence index is proposed in this study for design purpose by investigating geometrical cavity location in the ground that is to be used for checking stability of railway track.

*Keywords: cavity, FEA, subway, trackbed stability, influence factor*

### 1 Introduction

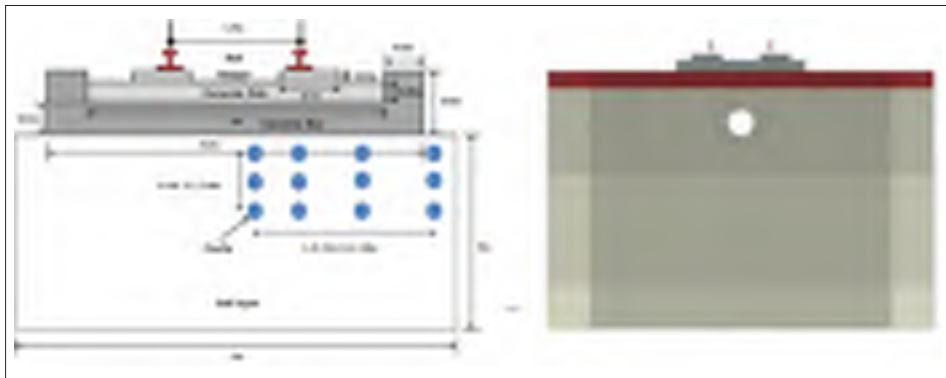
Cavities and sink holes are found many times recently in downtown of metropolitan cities due to old and damaged pipes installed in the ground long time ago. It is well known that the cavities are generated by spilling out of water from old utility pipes mostly. The cavities generated below subway track can cause irregularities and instability of the railway track. However, design method for railway track that can be used for checking stability of the track structure in subway is not developed yet when cavities are generated below the railway track. In this study, a commercial finite element program ABAQUS [1] is used to analyze the structural behavior of the track in cases of existence of cavities in subway trackbed foundation. Purpose of study is to find out the most important influence factors on the structural stability of track that has a cavity below the track. Also, it is to develop a simple design method for railway track in case of cavity existence in the trackbed foundation. Influence index that can be used for checking stability of railway track with a cavity below the track is proposed for design purpose by checking cavity location in the ground geometrically. Sensitivity analyses of the railway track using finite element analysis are performed for checking allowable deformation of the track that are generated by cavity existence.



## 2 Finite element analysis

### 2.1 Finite element modelling of track with cavity

In order to develop design chart for stability of trackbed foundation in case of cavity existence below railway track, three dimensional finite element analyses (FEA) are performed broadly. Computed settlements from the FEA are compared to critical allowable values defined by design code. A conceptual design for parametric study of FEA and the finite element mesh used for the analyses are explained in Fig. 1. Finite element mesh is modeled as axisymmetric and two independent axial loads are applied on top of the rails in order to simulate wheel load acting on the rail. The loads are computed by considering DAF (Dynamic Amplification Factor) with design velocity of subway rail cars. Infinite elements are used at the boundaries for reducing reflected energy waves that can affect FEA results such as displacements on top of rail flange. With change of diameter of the cavity, vertical deflections on the top of rails are computed from the FEA. The dimensions and the material characteristics of the elements used for the FEA are those requested by the Korean Railway Authority’s (KR) design code [2] (Figure 1 and Table 1)



**Figure 1** Conceptual design for parametric study of FEA and a typical finite element mesh used for the analysis

The cavities are assumed to be located at positions of  $L = 0, 0.8, 1.5, 2.8$  m where  $L$  is horizontal distance from the center of railway track as shown in Figure 1. Diameters of the cavities are assumed as 0.3, 0.6, and 1.2 m. Geostatic stresses are generated by applying gravity forces based on unit weight of the soil. Thus, all computed stresses in the ground due to loading on the top of rail are represented by the following equation:

$$\sigma_v' = \sigma_{v0}' + \Delta\sigma_v \tag{1}$$

**Table 1** Material input values used in numerical analysis.

Division	Modulus E [MN/m <sup>2</sup> ]	Poison's ratio $\nu$	Density $\rho$ [ton/m <sup>3</sup> ]	Damping	
				$\alpha$	$\beta$
Rail	210,000	0.167	7.85	30.81	5.00E-05
Sleeper	30,000	0.17	2.8	0.4	0.00073
Concrete Slab	30,000	0.17	2.8	0.4	0.00073
Concrete Box	23,000	0.15	2.4	0.4	0.00073
Soil	50, 80, 120	0.3	2	0.4	0.00073

Axial load (Q) of subway train used in Seoul Metro is 120 kN so that static wheel load ( $Q_w$ ) is 60 kN. Design wheel loads ( $Q_{w-dyn}$ ) are calculated by considering effective wheel load ( $Q_{w-eff}$ ) and maximum design velocity (80 km/h) of subway train adapted in Seoul Metro so that pseudo-static wheel load with using DAF (Dynamic Amplification Factor) is computed as 86 kN and is applied on top of the rail. Usually, effective wheel load is 20% bigger than static wheel load. For calculation of DAF, the following well-known equation [1][3][4] is adapted:

$$DAF = 1 + t\phi(1.0 + 0.5 \frac{V-60}{190}) \quad (2)$$

Where:

V – design train velocity;

t – the factor depending on confidence interval (=1);

$\phi$  – coefficient for track condition (=0.2).

When the wheel loads are applied on the track, vertical displacements on the top of rail are calculated by FEA. The all computed vertical displacements obtained from FEA are collected and analyzed in order to develop design charts for checking stability of the railway track in subway when a cavity is generated below the track.

## 2.2 Sensitivity analysis

KR(Korean Rail Authority) design code [1] for railway track describes total allowable vertical displacement ( $\delta_{allow}$ ) including residual displacement and elastic displacement to be less than 30mm after completion of construction of formation level. However, it is required in the code that elastic vertical displacement generated due to wheel load of railway train should be less than 5mm. This means that the vertical displacement of trackbed should be less than 25mm. In this study, the allowable elastic displacement due to wheel load is selected as 5mm in subway structure even though, in usual, more displacement can be allowed by using rail fastening device.

Sensitivity analysis is performed by changing different values of parameters such as elastic modulus of soil (E), diameter of cavity (D), depth of cavity (z). In case of cavity existence below trackbed foundation, all of the parameters E, D and z are regarded as important and critical parameters that can affect vertical displacement on the top of concrete slab used as trackbed as shown in the following figure. As shown in the figure, the concrete slab representing trackbed structure can be regarded as long strip foundation when two wheel loads are applied on top of rails. Therefore, vertical displacement computed at the centre of rails is assumed to be calculated by the following equation which is a modified form of existing equation for calculation of settlement of shallow foundation on elastic half space [5] :

$$\delta_{critical} = \frac{qB \times (1 - \nu^2) E}{qE} I_{cavity} \quad (3)$$

Where:

$\delta_{critical}$  – critical vertical displacement at the centre of rail (shown as red circle in the figure) when a cavity is located below trackbed structure (mm);

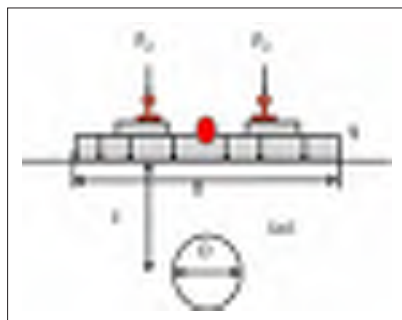
q – vertical distributed load at the bottom of concrete slab generated due to wheel load [kN/m<sup>2</sup>/m];

$\nu$  – Poisson's ratio of soil;

E – elastic modulus of soil;

$I_{cavity}$  – influence index of vertical displacement when a cavity is located below trackbed structure.

The influence index ( $I_{cavity}$ ) is assumed to be function of depth  $z$ , elastic modulus  $E$ , cavity diameter  $D$  and horizontal distance from the centre of loading to centre of the cavity  $h$ . In order to use the eqn (3), when a cavity exists below the trackbed, the influence index ( $I_{cavity}$ ) should be known.



**Figure 2** Conceptual diagram of loading on the track and position of vertical displacement computed in case of cavity existence below trackbed.

As defined by Schmertmann [6], settlement estimation of shallow foundation is based on simplified distribution of vertical strain under the centre of a shallow footing, and is expressed as the following equation with the form of strain influence factor ( $I_z$ ):

$$\epsilon_v = \frac{q}{E} \times I_z \quad (4)$$

Unlike the assumed distribution of vertical strain influence factor with depth proposed by Schmertmann[6], the influence index ( $I_{cavity}$ ) used in this study is assumed as a function of Geometrical Function (GF) that is defined as the following equation:

$$I_{cavity} = f(GF) = f\{S(D/hz)^n\} = A^m S \cdot (D/hz)^n \quad (5)$$

where the geometrical function GF is assumed again to be dependent on cavity diameter  $D$ , depth of the cavity  $z$  and horizontal distance of the cavity from the center of track  $h$  as shown in eqn. (5). The geometrical function can be obtained from parametric study about track stability by FEA when a cavity exists below the track. In order to get GF, a statistical analysis is run using SPSS program by changing parameters  $D$ ,  $h$  and  $z$  in FEA. Method to obtain a basic form of GF is to integrate vertical strain energy consumed in the area of interest with different parameters of  $D$ ,  $h$  and  $z$ . Therefore, The factor  $A$  shown in eqn 5 is obtained from strain energy consumed due to loading to the track with a cavity. SPSS analysis with various parameters  $D$ ,  $h$  and  $z$  can provide factors  $A$  and  $n$ ,  $m$  in eqn (5).

If influence index ( $I_{cavity}$ ) is known, it is possible to check stability of trackbed foundation structure based on the eqn (1) by computing vertical displacement. The first and easiest way to check stability of the track with a cavity is to get normalized vertical strain ( $\epsilon_v$ ) on the surface of the concrete slab (sleeper) when diameter  $D$  and depth  $z$  (location) of a cavity are known by GPR and elastic modulus  $E$  is measured by LFWD. As shown in Figure 3, the normalized vertical strain ( $\epsilon_v$ ) computed by using measured vertical displacement ( $\delta$ ) and assumed effective depth  $4B$  where slab or sleeper width  $B$  (ex.  $B = 3$  m) is represented and compared with different combination of depth  $z$  and diameter  $D$  of a cavity. Figure 3 represents a special case with a cavity in the ground located directly below the centre of the track. In order to provide the curves in Figure 3, computed vertical displacements from FEA based on modelling of loaded

track structure as shown in Figures 1 and 2 are used to get normalized vertical strain ( $\epsilon_v$ ). By selecting different combinations of values of the critical parameters E, D and z when a cavity is detected and is assumed to exist directly below the center of the track, evident trend lines between normalized vertical strains and depth/diameter ( $z/D$ ) can be obtained as shown in Figure 3. For getting the curves in the figure, distributed load at the bottom of the slab q is assumed as 68 kPa, B = 3 m and Poisson's ration is 0.3. From the curves shown in Figure 3, the following meanings can be obtained:

- 1) The normalized vertical strains ( $\epsilon_v$ ) decreases with increase of elastic modulus of the soil (E).
- 2) The normalized vertical strains ( $\epsilon_v$ ) decreases with increase of depth of the cavity (z).
- 3) The normalized vertical strains ( $\epsilon_v$ ) increases with increases of diameter of the cavity (D).

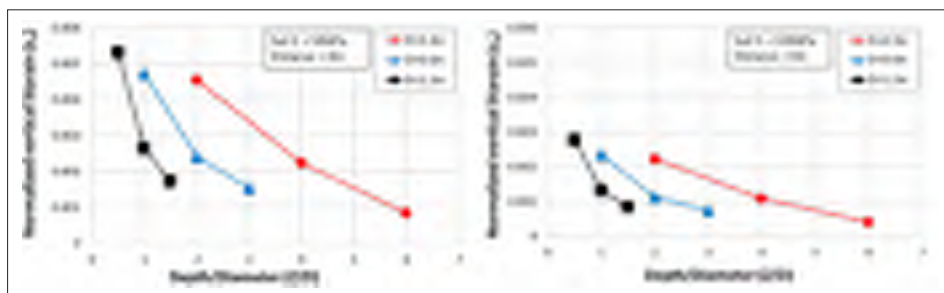


Figure 3 Normalized vertical strain( $\epsilon_v$ ) ~ z/D curves

A regression is performed to get optimized graphs as shown in Figure 4 based on data represented in Figure 3. The obtained vertical strains ( $\epsilon_v$ ) in Figure 4 can be used to determine possibility of instability of the track with a cavity based the maximum vertical elastic displacement generated due to wheel load of railway train that should be less than 5 mm. With different combination of z/D, it is possible to check stability of track with a cavity when a cavity size and depth are known.

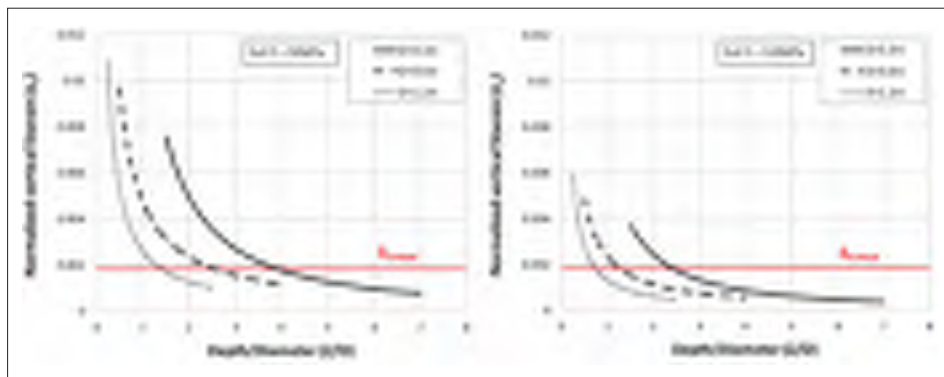


Figure 4 Normalized vertical strain( $\epsilon_v$ ) ~ z/D curves

### 3 Conclusions

Cavities are found many times recently in downtown of metropolitan cities due to old and damaged pipes installed in the ground. The cavities are generated by spilling out of water from pipes mostly. The cavities generated below subway track can make irregularities and instability of the track. In this study, a finite element program ABAQUS is used to analyze the

structural behavior of the track in cases of existence of cavities in subway trackbed foundation. It is found from the FE analysis that there can be a lot of differences in displacement of the track, depending on soil modulus, depth and diameter of cavity. The most important influence factors on the structural stability of track can be provided from the analysis in case of cavity existence in the trackbed foundation. Influence index is proposed in this study for design purpose by investigating geometrical cavity location in the ground that is to be used for checking stability of railway track. It is found from the FE analysis that there can be great differences in vertical displacement of the track with a cavity, depending on soil modulus  $E$ , depth  $z$  and diameter of cavity  $D$ .

## References

- [1] Simulia, ABAQUS manual, 2015
- [2] Korea Railway Authority, Railway Design Code, 2012
- [3] Esveld, C.: Modern Railway Track, Second edition, MRT Productions, 2001.
- [4] Lichtberger, B.: Track Compendium, Eurail Press, 2005
- [5] Timoshenko, S., Goodier, J. N.: Theory of Elasticity, 2<sup>nd</sup> ed., McGraw-Hill, New York
- [6] Schmertmann, J.: Static Cone to Compute Static Settlement over Sand, Journal of the Soil Mechanics and Foundation Division, Proc. ASCE, 96, SM3, pp. 1011-1043, 1970.



## PROPOSAL FOR THE WHEEL PROFILE OF THE NEW TRAM-TRAIN VEHICLE IN HUNGARY

**Péter Bocz, Ákos Vinkó**

*Budapest University of Technology and Economics, Department of Highway and Railway Engineering, Hungary*

### Abstract

The first integrated railway system in Hungary (“tram-train”) is currently in planning phase, between Szeged and Hódmezővásárhely. The implementation of this system requires a special vehicle which has the ability to operate both on tramway infrastructures and also on conventional railways, and the necessary construction and reconstruction of tracks, as well. Some European manufacturers offer suitable vehicles, which requires a well-planned special wheel profile due to differences on the two types of infrastructure. Examples of mixed-mode wheel profiles are known in the case of existing Tram-Train systems, but for the present circumstances, domestic specialties, the proper shape of the wheel profile has to be developed, taking into account the domestic norms and standards.

The main goal of this article is to develop a proper wheel profile geometry for the new Hungarian Tram-Train vehicle, taking into account the current tram and conventional rail wheel profiles, as well as the track infrastructure (e.g. rail profiles, curves, turnouts). The applied tram and conventional rail wheel profiles are now different. Operating a rail wheel profile on the tram network is not possible due to the grooved rails, short radius curves and the special turnout solutions. The running of the tram wheel profile is not proper on the conventional rail network, principally on turnouts, and the higher speed is not favourable as well. Particular care should be taken to the permissible rail and wheel profile with wear, because the wheels have to be able to run on rails worn to the authorized limit.

*Keywords: tram, tram-train, wheel profile, flange, turnout*

### 1 Introduction

The introduction of the first Tram-train system in Hungary is in planning phase around the city of Szeged, a settlement in the southern part of Hungary. The reconstruction of tram line 1 (Szeged Main Railway Station – Szeged Plaza shopping mall, across the city area) was realized between 2009 and 2011. The current plan is to use this line as part of an integrated rail system, connecting to the nearby Szeged – Békéscsaba railway line, at the terminus of Szeged Plaza. For this project a new wheel profile has to be developed in order to be able to run on both types of infrastructure. Because of compatibility problems the change on conventional rail infrastructure it is not possible, however, the light rail infrastructure facilities are suggested to remain unchanged, according to its age and good condition. Fortunately the two types of railway has the same gauge, so it is not a problem.

## 2 Wheel profiles applied in Hungary

### 2.1 Railway wheel profiles

The wheel profiles used on the Hungarian railway network are partially according to the harmonized European standards (wheel profile UIC-ERRI S1002, defined by EN 13715), and some specific wheel profiles are also used (MÁV, K5 and MÁV K6). A common feature of the wheel profiles is the similarity for the rail head geometry, which means the appearance of radii of R320, R80 and R14 mm on the wheel tread (Fig. 1).

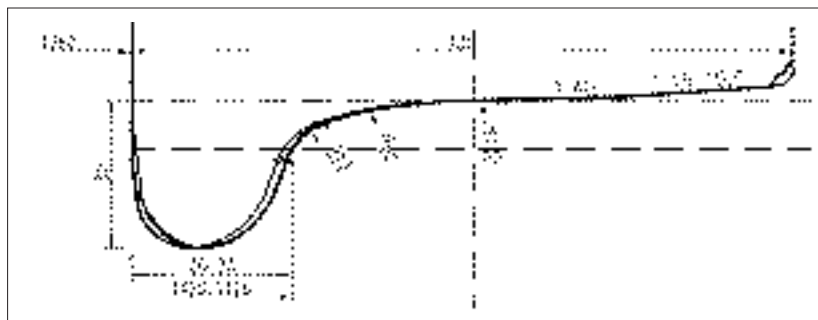


Figure 1 Railway wheel profiles used in Hungary

### 2.2 Tram wheel profiles

The standard wheel profile on the tram vehicles in Szeged is a conical profile, with a narrow rim-tyre and a narrow flange width (Fig. 2). The rounding radius at the gauge corner is 13 mm. Due to the passing on the turnouts with flat groove, the flange tip is flat on a 10 mm long section. The flange back has a 15° angle to the vertical. Nowadays a newer tram wheel profile is under propagation in Budapest and in Szeged as well, which has advanced tread shape. (dashed line in Fig. 2)

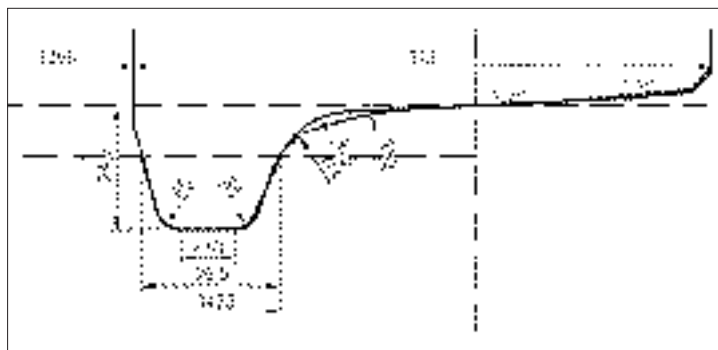


Figure 2 Tram wheel profiles used in Hungary

### 2.3 Comparison of wheel profile geometries

The two types of the wheel profile has many differences as seen in Table 1. This means difference in geometric and in size.

**Table 1** Differences between the two types of wheel profile.

Properties	Conventional railway	Tramway
Wheel back-to-back	1360 mm	1366 mm
Rim tyre width	wide (135 mm)	narrow (124 mm)
Wheel tread	compound (varying radii)	conical (1:20)
Flange width	wide (30..33 mm)	narrow (26,9 mm)
Flange height	high (28,30,32 mm)	low (24,2 mm)
Flange tip	rounded	flat (~10 mm wide)
Flange back	vertical	oblique (15,1°to vert.)

### 3 Geometric examinations on wheel-rail contact

Because of the difference between the wheel profiles as described in Section 2.3., the run of the different wheel profiles on the other infrastructure can have problems. The suitability of the railway wheel profile on the tram infrastructure and the tram wheel profile on the conventional railway track have to be examined.

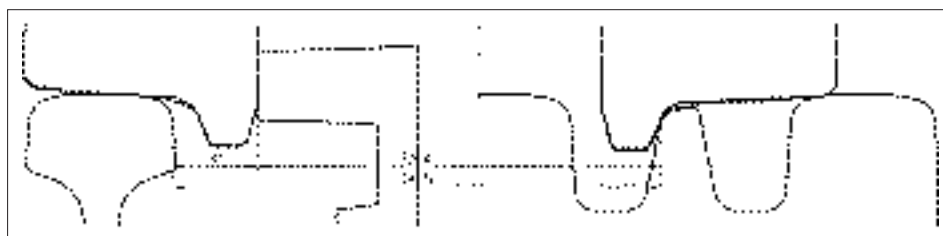
#### 3.1 Conventional railway open track

In Hungary UIC54 and MÁV48 (this is a specific Hungarian profile) rail profiles are widely used on the railway network, with 1/20 rail inclination. On the reconstructed TEN-T railway network 1/40 rail inclination is also used since the year of 2000.

The tram wheel profile can properly run on the conventional rail lines, because it has smaller flange dimensions (width and height) than the rail wheel profile. In addition the same superstructure is used on tram lines in suburban areas, with ballasted track. Therefore, this type of track has the lowest affect to the specification of the new Tram-train wheel profile geometry, if the dimensions of the designed profile have the size between the two types of wheel profile dimensions.

#### 3.2 Conventional railway turnouts

The railway turnouts have two essential points related to the wheel run: the front of the tongue rail and the common crossing (frog). In the case of the tongue rail, the  $q_r$  distance related to the shape of the flange is dominant to avoid derailment at the front of the tongue rail. This value is significantly less in the case of tram wheel, and does not reach the railway standards.



**Figure 3** Tram wheel profile in railway track turnout

At the common crossing (See Fig. 3), the dominant size is the wheel back-to-back distance. With a large back-to-back distance the check rail cannot avoid the nose of the crossing from the collision. The tram wheel has not the proper size. During the bypass on the common crossing, some lack of support can be formed. To avoid this, a wing rail can be used, but on



steep crossing angles and with narrow rim-tyre width (like the Szeged tram wheel profile has) this method has not enough effect. In summary, the run of the tram wheel profiles are not supported on the railway turnouts due to its size.

### 3.3 Tram open track

On the tram network, mainly on paved superstructures, grooved rails are used. In Szeged the 59R2 rail profile is widely used on straight and curved sections equally, which has 42 mm groove width. In small radius curves ( $R < 40\text{m}$ ) a “Ph37a” profile is used with extended (58 mm) groove width. Because of the narrow groove the train wheel profile with a wide flange does not have a possibility to run without touching the sidewall of the groove. This effect is serious in small radius curves, where cross-run of the bogie can be experienced.

### 3.4 Tram turnouts

On the Szeged tram network flat groove turnouts are applied, in which the maximum running speed is 15 km/h in both direction. In the monoblock common crossing the wheelset is running on the flange tip of the profile (called synchronous flat groove crossing), so the support of the wheel is continuous in the whole crossing area. But due to the high contact pressure between the rail and a narrow flange tip, wear can quickly occur in the bottom of the groove. The rounded flange tip used on conventional railways is not suitable to run in flat groove crossing due to the higher contact pressure. Moreover, in the Hungarian grooved turnouts a 36 mm narrow grooved 60R2 rail profile is applied, in which the train wheel profile cannot fit due to the wide flange, so a double flangeback guidance can occur (see Fig. 4.)

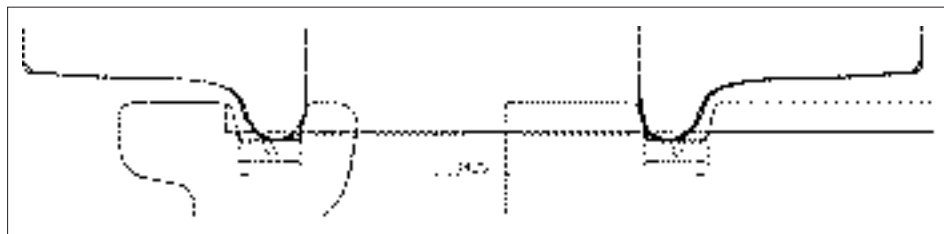


Figure 4 Railway wheel profile on tram flat-groove turnout

## 4 Proposal for the geometry of the Tram-train wheel profile

As seen in Section 3., none of the currently used wheel profiles are suitable for running on both types of infrastructure. It is necessary to develop a modified wheel profile, which is as much as possible comply with the current regulations. The difference from the standards can be allowed if it is not compromise safety.

The rim tyre width has to meet the railway standards (135 mm), which is required to run on railway crossings. This size is not problem for the tram infrastructure, because although tram wheel profiles under the current regulations only 124 mm wide, the old nostalgic vehicles' wider tyre (130 mm) has taken into account during the Szeged tram line reconstruction. Given the disparities in the wheel back distances of 6 mm it means only a 132 mm tyre width, which fit into the acceptable range defined by the standard.

The wheel back-to-back distance has to comply with the railway standards (1360 mm), otherwise the crossing section of the turnouts cannot work, the check rails cannot perform their duties, as set out in Section 3.2. shown above.

The wheel tread profile is suggested to match the UIC ERRI S1002 profiles, which is widely used in Hungarian railcars and EMUs, gained a good experience with them, so there is no reason to change. This profile is not significantly different from the tread section of the modern wheel profiles nowadays started to use on tram vehicles in Hungary as well. The flange width of the S1002 profile may vary as described in [7], so the suitable flange width is 31,5 mm according to 1423 mm flange face width in tram regulations.

The difficulty to develop a proper wheel profile is originating from the flange width. This size has an upper limit from the aspect of tram infrastructure, because of the groove width given by the available network. The flange width consists of three main sections: flange face size  $q_R$ , width of flange tip (flat section) and projection of the oblique flange back section. All three factors has an expedient minimum value, which are administered with the flange width, however, not collectively exceed the tram wheel regulations. The minimum value of the flange face size  $q_R$  is 6.5 mm, that the design value should exceed, so wear spare is available, thus the minimum value of  $q_R = 8$  mm was determined. The now used tram wheel profile has a flange tip width of 10 mm, this (or almost this) size is necessary to bypass on the flat bottom turnout crossings. In the case of the flangeback section, steeper angle can reduce this, however, this angle shall not exceed the sidewall angle of the used grooved rails (slope = 1 : 6, angle = 9.5 °).

The height of flange need to be preferably aligned to the tram standards. However, according to the wheel profile S1002 variants can be found in the standard, the  $q_R$  value can only be greater than the minimum required value of 8 mm if the flange height value has the minimum of 26 mm, otherwise the flange face has to be shortened. The new flange height is 1.8 mm greater than the current tram wheel standard of 24.2 mm. The groove is deep enough to run this higher profile, but the run on the flat groove turnout can be problematic.

Due to adverse experiences on flat groove turnouts some minor changes are suggested to be achieved. The essence of this suggestion is that with deepening of flat grooves a favourable wheel-rail contact can be realized. In this case the support of the wheel can be divided between the flange tip and the running surface, reducing the high contact pressure on the flange tip. The groove depth has to be exactly the same size than the flange height to realize this effect. Now the groove is 18 mm deep, the proposed value is 26 mm, according to the new Tram-train wheel profile. In this case the current tram wheel profiles have to be partially modified.

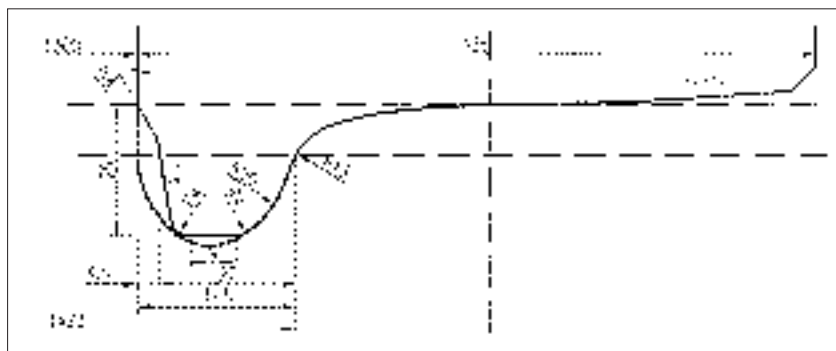


Figure 5 Proposed Tram-train wheel profile compared to the UIC-ERRI S1002 rail wheel profile

## 5 Conclusion

In this article the geometrical development of a tram-train wheel profile was presented. The wheel profile is able to operate on both of the railway and tram infrastructure comes from the EN 13175 standard, defined as UIC ERRI S1002. This widely used profile ensures that there will

be appropriate running on the railway track. The flange shape and dimensions, however, do not agree the regulations valid for the railway network, because of the problems at some point of the tram network such as grooved rails and turnout crossings. Thus, the flange dimensions of the designed new wheel profile are modified, to be closer to the tram wheel profiles, but they do not fully agree with that.

This solution is a compromise between the two types of wheel profile so it cannot fully meet any of the standards. Therefore, specific authorization is required, but this is the price of the introduction of integrated transport system.

The designed wheel profile works on the railway network in the same way as a standard rail wheel profile, due to the relevant dimensions comply with that. The running surface profile determining the dynamic behaviour and the equivalent conicity is identical to a standard wheel profile UIC ERRI S1002. The  $q_r$  value essential for the derailment safety meets the standard requirements but lower than the corresponding standard wheel profile value. The main dimensions needed to proper passing in railway turnouts, like the rim tyre width and the wheel back-to-back distance are also the same as the rail standards.

The proposed wheel profile can work also fine on the urban rail network. The S1002 tread profile has not disadvantages on the tram rails as the tram operators get some new positive experiences with modified running surface tram wheel. The flange tip width is a little bit smaller than the present values, but the proposal to change the turnout crossing geometry can avoid the system from that high contact pressure. The flange width nominal value is the same as the present tram wheel profile, so the flange can fit in the groove in any case the present profiles do.

Because of the nature of pilot project and special circumstances after 1 year operation field measurements have to be made to gather experiences. Depending on examination results possible minor changes on the developed wheel profile can be executed.

## References

- [1] D.54. Track Construction and Maintenance parameters and regulations. (MÁV Ltd., 1987)
- [2] Track Alignment Design Rules of National Railways. (KÖZDOK, Budapest, 1983)
- [3] MÁV SZ 2616:2003 Wheels and Wheelsets. Main features and dimensions. (MÁV Ltd. Standard)
- [4] COMMISSION REGULATION (EU) No 1302/2014 of 18 November 2014 concerning a technical specification for interoperability relating to the 'rolling stock — locomotives and passenger rolling stock' subsystem of the rail system in the European Union.
- [5] COMMISSION REGULATION (EU) No 1299/2014 of 18 November 2014 on the technical specifications for interoperability relating to the 'infrastructure' subsystem of the rail system in the European Union
- [6] UIC 510-2-2004 Trailing Stock: Wheels & Wheelsets. Conditions concerning use of wheels of various diameter.
- [7] EN 13715:2006+A1:2011 Railway applications. Wheelsets and bogies. Wheels. Tread profile.
- [8] MSZ 07-5003:1990 Periodical inspection of tired and monoblock wheel-sets of electrical trams. (Hungarian Standard)
- [9] MSZ 07-5007:1978 Wheel-sets for tramways, suburban and rapid trains. Wheel-sets for suburban and underground railway vehicles. Requirements. Acceptance controls. (Hungarian Standard)
- [10] Multisystem concepts of railways in Europe, <http://www.karr.de/veroeffentlichungen>, 15.03.2016.



## FLOW ON THE BALLASTED TRACKBED WITH PERMEABLE SURFACES AND ITS INFLUENCE ON THE BALLAST FLIGHT

Jianyue Zhu, Zhiwei Hu

*University of Southampton, Faculty of Engineering and the Environment,  
Aerodynamics and Flight Mechanics Research Group, United Kingdom*

### Abstract

Related to the train underfloor carbody aerodynamics, a phenomenon of ballast flight occurs frequently associated with the operation of high-speed railways. Ballast flight will cause rail defect known as “ballast pitting” which is formed by the small ballast particles becoming trapped between the rail running surface and the vehicle wheels. Generally, the ballast particles have irregular shapes and are distributed on the trackbed which has a permeable surface. The flow developed beneath a high-speed train running on a ballasted track and around the ballast particles is turbulent and has strong influence on the ballast flight. This paper investigates the aerodynamic behaviour of the flow past the ballasted trackbed with permeable surfaces using computational fluid dynamics based on the delayed detached-eddy simulation. It is found that the flow field is highly unsteady due to strong flow separations and interactions developed around the gaps of the permeable surfaces. The ballast particles located on the permeable surfaces are situated in the stronger turbulent flow and are subject to larger fluctuating lift force than the particles located on solid surfaces. Moreover, the fluctuating lift, drag and side forces increase when the ballast particles are located beneath the bogie cavity area. When the ballast particles become airborne, the fluctuating forces generated around them increase greatly since the particles are situated in the unsteady flow with more flow interactions. Therefore, the stronger unsteady flow developed around the trackbed with a permeable surface will produce larger fluctuating forces on the ballast particles, which will be more likely to cause ballast flights for high-speed railways.

*Keywords: ballast flight, flow behaviour, ballasted trackbed, permeable surface, aerodynamic forces*

### 1 Introduction

High-speed rail networks are being developed rapidly around the world. Many investigations have been made to understand the aerodynamics of high-speed trains [1,2]. Related to the underfloor carbody aerodynamics, a phenomenon of ballast flight under normal meteorological conditions occurs more frequently and the railhead damage known as “ballast pitting” has become more popular associated with the operation of high-speed railways. This rail defect is formed by the small ballast particles becoming trapped between the rail running surface and the vehicle wheels. In order to understand the mechanism of the ballast flight, a full-scale field experiment was carried out to investigate the aerodynamic and mechanical forces acting on ballast particles which were generated during the passage of a high-speed train [3]. Moreover, an analytical model was established to identify the factors causing the small ballast particles being ejected from the trackbed. It was found that ballast flight could arise from a combination of aerodynamic and mechanical effects and the process was stochastic [3]. The basic charac-

teristics of the flow between the underbody of a high-speed train and the ground have been studied numerically based on a turbulent Couette flow model to simplify the calculation [4]. Results showed that an equivalent roughness of the trackbed made of sleepers and ballast could be obtained based on this analytical method. Additionally, a full-scale numerical simulation of the ICE3 (inter-city express) geometry based on Reynolds-averaged Navier-Stokes investigation together with a wall function approach was performed. It was found that the boundary layer was developed considerably in the train underfloor region due to the generation of turbulence and secondary flow in the vicinity of the bogies. Moreover, the skin friction was increased significantly immediately downstream of the inter-car gap. It was pointed out by the authors that these numerical results were needed to improve confidence by grid independence study as they didn't correspond well with the experimental measurements [5].

The mechanisms of the ballast flight are still not well understood [3, 5]. The flow beneath a high-speed train running on a ballasted track is highly unsteady and has strong influence on the behaviour of the ballast flight. Generally, ballast particles have irregular shapes and are distributed adjacent to the other ballast particles on the trackbed; thus the small gaps are formed between the ballast particles, which can be modelled as particles located on a permeable surface. This paper aims to investigate the aerodynamic behaviour of the flow past the ballasted trackbed with permeable surfaces using the numerical simulations.

## 2 Numerical method

Aerodynamically, high-speed trains are operating within the low Mach number flow regime, for example at 300 km/h the Mach number is about 0.25. The incoming flow (30 m/s) simulated in this paper is at a low Mach number of 0.09 and thereby the compressibility effects on hydrodynamic airflow field are small and thus can be neglected. Therefore, the unsteady, incompressible Navier-Stokes equations are used to solve the flow field. The continuity and momentum equations in tensor notation are given by:

$$\frac{\partial u_i}{\partial x_i} = 0 \quad (1)$$

$$\frac{\partial u_i}{\partial t} + u_j \frac{\partial u_i}{\partial x_j} = f_i - \frac{1}{\rho} \frac{\partial p}{\partial x_i} + \nu \frac{\partial^2 u_i}{\partial x_j \partial x_j} \quad (2)$$

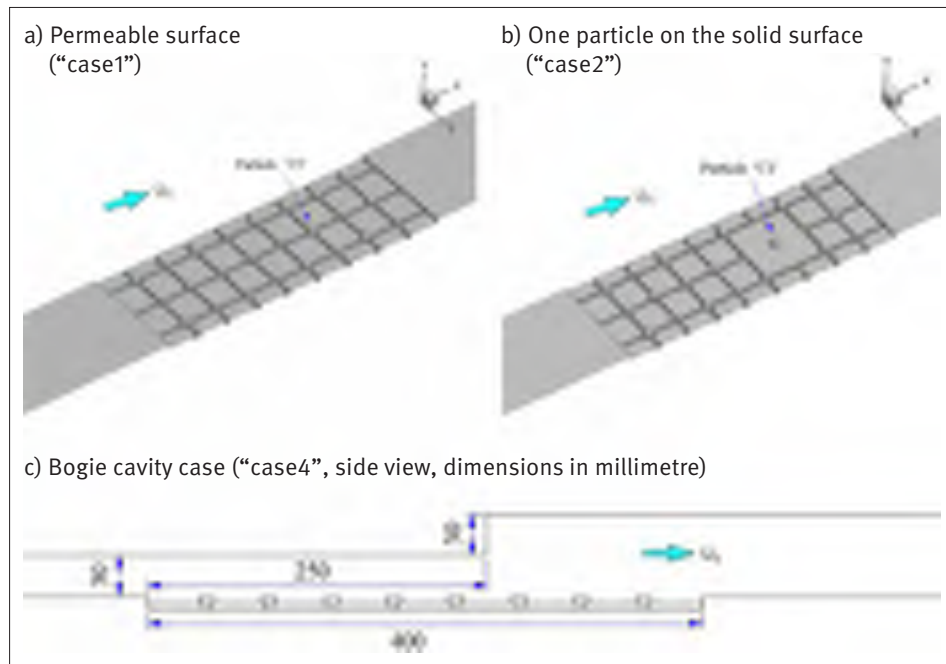
where  $x_i$  represents the Cartesian coordinates in the streamwise, crossflow and vertical directions for  $i = 1, 2, 3$ .  $p$  is the pressure,  $\rho$  is the density,  $\nu$  the kinematic viscosity,  $f_i$  is the body force and  $u_i$  the flow velocity components. Here  $\rho$  and  $\nu$  are constants for incompressible flow. The open source software OpenFOAM-2.2.1 is employed to solve the governing equations numerically. A second-order accuracy scheme is utilized for the convection and diffusion terms of the spatial derivatives and the temporal discretization follows a second-order fully implicit scheme. The pressure-velocity algorithm PIMPLE, combining PISO (pressure implicit with splitting of operator) and SIMPLE (semi-implicit method for pressure-linked equations) algorithms, is applied to solve iteratively the resulting discretized linear-algebra equation system. The delayed detached-eddy simulation (DDES) model based on the Spalart-Allmaras turbulence model is employed for the current flow calculations [6].

## 3 Simulation setup

The three-dimensional models of ballasted trackbed with permeable surfaces and ballast particles used in this study are displayed in Figure 1. The ballast particles have dimensions of 10 mm, 10 mm and 5 mm in the streamwise, spanwise and vertical directions, respectively

and are connected to the trackbed on the four corners with an area of 2 mm × 2 mm. The width and depth of the gap of the permeable surface are 6 mm and 5 mm. The junction area of the gaps without the ballast particles are filled by the blocks with dimensions of 6 mm × 6 mm × 5 mm along the streamwise, spanwise and vertical directions, respectively. The length of the ballastbed is 0.4 m corresponds to the gap between two adjacent sleepers in reality. There are four cases simulated here: the “case1” represents the case of all particles attached on the permeable surface (Figure 1a); to change the ballast surface around the particle “C1” to solid and have the same incoming flow from the permeable surface, the “case2” is built as shown in Figure 1 (b); based on the “case2”, the “case3” has a gap of 2 mm between the particle “C1” bottom and the trackbed top surface; with the bogie cavity added to the “case1”, the “case4” is used to investigate the influence of train undercarriage turbulent flow and sketched in Figure 1 (c) with the main dimensions.

Based on the grid convergence study for a cylinder case [7,8], a fully block-structured mesh is generated around all the geometries. The first point is set as  $1 \times 10^{-5}$  m from the wall surfaces and grows at a ratio of 1.1 inside the boundary layer. This yields a maximum value of  $y^+$  (the dimensionless first-cell spacing,  $y^+ = yu_\tau/\nu$  where  $y$  is the distance from the wall,  $u_\tau$  the friction velocity and  $\nu$  kinetic viscosity) less than 1 for all cases to ensure that the boundary layer is resolved properly and the turbulence model employed can account for the low-Reynolds number effects inside the viscous sublayer. This grid generation strategy results in a total number of grid points of 33.2 million in the entire domain for the “case1”; 32.3 million for the “case2”; 33.3 million for the “case3”; and 39.1 million for the “case4”. For the case of permeable surfaces around the ballast particle “C1” (“case1”), another coarse mesh with 19.6 million grid points was also used for simulations and the results from the two meshes with different resolutions were very close (the discrepancies in root-mean-square (RMS) and mean values of aerodynamic force coefficients for the ballast particle “C1” are less than 7%), as shown in Table 1. The meshes with fine resolution will be used for all the simulations.



**Figure 1** Simplified models of ballasted trackbed with permeable surfaces

**Table 1** Root-mean-square and mean values of aerodynamic force coefficients for the ballast particle “C1”

		Coarse mesh	Fine mesh	Discrepancy
RMS value	Fluctuating lift	0.5486	0.5143	6.67%
	Fluctuating drag	0.4507	0.4222	6.75%
	Fluctuating side force	0.3398	0.3186	6.65%
Mean value	Lift coefficient	1.602	1.5415	3.92%
	Drag coefficient	2.7142	2.7157	0.06%
	Side force coefficient	-0.0938	-0.0942	0.43%

The boundary conditions applied are as follows: the upstream inlet flow is represented as a steady uniform flow of 30 m/s ( $U_0$ ) with a low turbulence intensity. The side boundaries are specified as periodic boundary conditions; a pressure outlet with zero gauge pressure is imposed at the downstream exit boundary; all solid surfaces are defined as stationary no-slip walls. Simulations are run with a physical timestep size of  $1 \times 10^{-6}$  s initially and then followed by  $2 \times 10^{-6}$  s which gives an adequate temporal resolution for the implicit time marching scheme used with a Courant-Friedrichs-Lewy (CFL) number of less than 1 within the whole computational domain.

## 4 Simulation results

In order to understand the flow behaviour around the ballast particles located on the ballasted trackbed with the permeable surfaces, the calculation results of the instantaneous iso-surfaces of Q-criterion and the velocity fields are displayed to get an overview of the unsteady flow developed around the geometries; then, the fluctuating force coefficients of ballast particles are compared for different cases.

### 4.1 Instantaneous flow field

The flow structures developed around the permeable surfaces (“case1”), represented by the iso-surfaces of the normalized Q-criterion at the level of 1 (based on  $Q/[(U_0/l)^2]$ , where  $l$  is the particle length of 10 mm) are visualized in Figure 2. They are coloured by the non-dimensional velocity magnitude. It can be seen that various scales of vortices are formed along the gaps of the permeable surfaces as different flow interactions occur there. Moreover, a higher level of flow-field unsteadiness is developed around the leading edge of the rear sleeper where the strong flow impingements are generated.

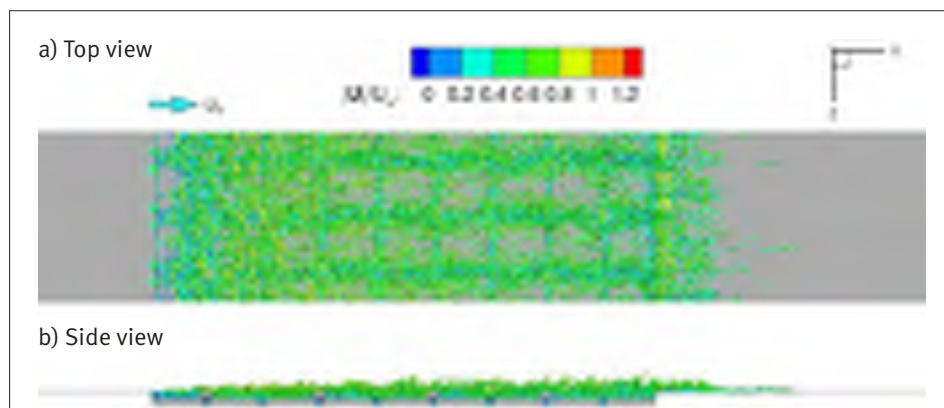
**Figure 2** Iso-surfaces of the instantaneous normalized Q-criterion



Figure 3 shows the flow structure developed around the permeable surfaces beneath the bogie cavity (“case4”), represented by the iso-surfaces of the normalized Q-criterion at a level of 0.5. It shows that a shear layer is developed from the cavity leading edge, and bent upwards in the streamwise direction. This shear layer travels downstream and interacts strongly with the flow developed in the bogie cavity. Subsequently, all vortices are mixed up and impinge on the upper wall of the cavity, leading to the unsteady flow with complex structure formed there. Figure 4 shows the instantaneous velocity field in vertical mid-span (“case4”). It can be seen that the shear layer developed from the cavity leading edge also has a strong interaction with the flow developed on the ballasted trackbed. Thus, a highly unsteady flow is formed between the bogie cavity and the trackbed. This makes ballast particles subject to stronger unsteady aerodynamic forces, which could lead to ballast flight happen.



Figure 3 Iso-surfaces of the instantaneous normalized Q-criterion (side view)

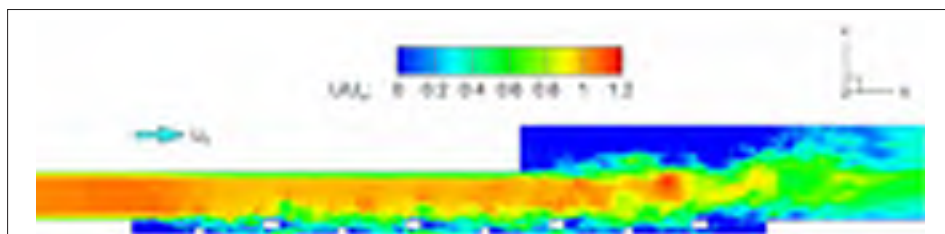


Figure 4 Contours of instantaneous velocity in vertical mid-span (side view)

Figure 5 shows the instantaneous velocity field at the ballast particle horizontal mid-plane from a top view in the bogie cavity case (“case4”). It can be seen that the flow separation occurs at the side edge of the ballast particle. The vortices formed in the front ballast particles’ wake are convected downstream and impinge on the rear ballast particles, causing more flow interactions around these regions and generating the unsteady flow along the trackbed.

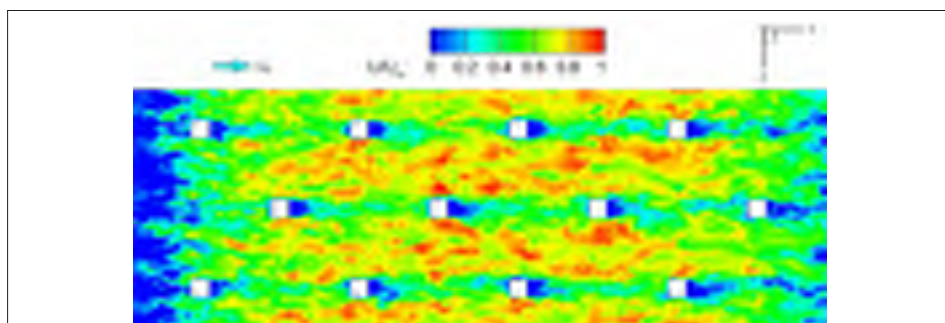


Figure 5 Contours of instantaneous velocity through the ballast particle horizontal mid-plane (top view)



## 4.2 Fluctuating forces on ballast particles

The comparisons of the root-mean-square fluctuating lift, drag and side force coefficients for one ballast particle (particle “C1” shown in Figure 1) of various cases, from the “case1” to the “case4” as described earlier, are presented in Figure 6. By comparing the results from the “case1” and the “case2”, it is found that the RMS value of the fluctuating lift force is higher while those of the drag and side forces are slightly lower when the particle is located on the permeable surface of the trackbed, making the ballast flight apt to occur. When the particle becomes airborne (“case3”), the fluctuating force, especially the lift force increases greatly compared to the particle attached to the permeable surface of the trackbed (“case1”). This is because when the ballast particle leaves the trackbed, it is situated in a more energetic turbulent flow, and thus strong flow interactions are developed around all surfaces of the particle and generate the high force fluctuations on it. Moreover, based on the comparisons between the “case4” and the “case1”, results show that all the forces increase as the ballast particles distributed beneath the bogie cavity where the unsteady flow development is relatively stronger, as discussed earlier. Therefore, the fluctuating forces generated on the ballast particles are directly affected by the turbulent flow developed around them. The unsteady flow generated around the region between the train underbody and the permeable ballasted trackbed will induce large fluctuating forces on the ballast particles situated within it and make the ballast flight more likely to happen.

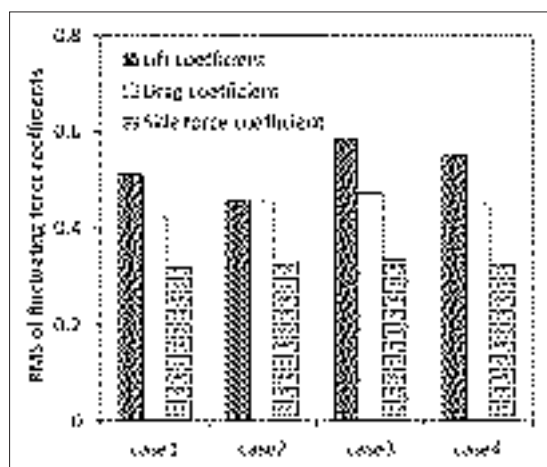


Figure 6 Root-mean-square of fluctuating force coefficients of ballast particles

## 5 Conclusions

The aerodynamic behaviour of the flow past the ballast particles on the permeable ballasted track and beneath the bogie cavity has been investigated using delayed detached-eddy simulation. Results show that compared to the particles attached on a solid surface, the ballast particles located on the permeable surfaces are situated in various flow interactions and are subject to larger fluctuating lift force. Moreover, when the permeable ballasted trackbed is located beneath the bogie cavity, a shear layer developed from the cavity leading edge has a strong interaction with the flow developed from the bogie cavity and the trackbed. All vortices are mixed up and convected downstream and a highly unsteady flow is generated due to the strong flow interactions occurring there. Thus, the larger fluctuating forces are induced on the ballast and make the ballast flight happen easily. When the ballast particles become

airborne, the fluctuating lift force increase greatly since the particles are situated in the more energetic turbulent flow.

Note that in reality the turbulent inflow and more detailed geometries present will lead to more complex flow structures and this will affect the induced forces on the ballast particles around the trackbed. The pressure pulse generated from the approaching train coupled with the severe mechanical vibration of the trackbed may play a key role in the initiation of ballast flight. The large turbulent fluctuations around the vehicle nose, inter-car gaps and tail region are apt to making the ballast particles airborne. All these factors need to be accounted for in the future work.

## Acknowledgements

This project was supported under the auspice of the Engineering and Physical Science Research Council (EP/K03765X/1). The numerical simulations were performed on the Iridis4 cluster managed by the University of Southampton.

## References

- [1] Baker, C. J.: The flow around high speed trains. *Journal of Wind Engineering and Industrial Aerodynamics*, 98, pp. 277-298, 2010.
- [2] Schetz, J. A.: Aerodynamics of high speed trains. *Annual Review of Fluid Mechanics*, 33, pp. 371-414, 2001.
- [3] Quinn, A. D., Hayward, M., Baker, C. J., Schmid, F., Priest, J. A., Powrie, W.: A full-scale experimental and modelling study of ballast flight under high-speed trains. *Proceedings of the Institution of Mechanical Engineers Part F, Journal of Rail and Rapid Transit*, 224, pp. 61-74, 2009.
- [4] García, J., Crespo, A., Berasarte, A., Goikoetxea, J.: Study of the flow between the train underbody and the ballast track. *Journal of Wind Engineering and Industrial Aerodynamics*, 99, pp. 1089-1098, 2011.
- [5] Kaltenbach, H.-J., Gautier, P.-E., Agirre, G., Orellano, A., Schroeder-Bodenstein, K., Testa, M., Tielkes, T.: Assessment of the aerodynamic loads on the trackbed causing ballast projection: results from the DEUFRAKO project aerodynamics in open air (AOA). *Proceedings of the World Congress on Rail research*, South Korea, 2008.
- [6] Spalart, P.R., Deck, S., Shur, M.L., Squires, K.D., Strelets, M.Kh., Travin, A.K.: A new version of detached-eddy simulation, resistant to ambiguous grid densities. *Theoretical and Computational Fluid Dynamics*, 20, pp. 181-195, 2006.
- [7] Zhu, J.Y., Hu, Z.W., Thompson, D.J.: Flow behaviour and aeroacoustic characteristics of a simplified high-speed train bogie. *Proceedings of the Institution of Mechanical Engineers Part F: Journal of Rail and Rapid Transit*, Published online September 30, 2015.
- [8] Zhu, J.Y.: Aerodynamic Noise of High-speed Train Bogies. PhD Thesis. University of Southampton, 2015.





## CONCRETE MIX DESIGN FOR THE REMEDY OF CORRODED CONCRETE SLEEPERS

Fitim Shala, Muhammad Umair Shaukat

*Al Mobty Company for Contracting, Riyadh Kingdom of Saudi Arabia*

### Abstract

The paper describes the main objectives and conclusions of concrete sleepers affected from salty soil and sulphates also to provide technical examination of the problem, as well estimation and technical proposals of concrete sleepers which are affected by sulphates along the existing railway line 18-41 km, which is under the maintenance of Almobty Company for Contracting. However, in order to proceed with any final technical evaluation and what more a decision to be taken, chemical analysis of the subsoil is mandatory. For this purpose, rail line should be disconnected and the ballast removed. Afterwards geotechnical analysis should follow with bore sample of 2 to 5 meters deep, as well as surface sample, as per test specifications. The same procedure should be followed every 100 meters in the effected line. Our estimation is that additional samples of the same nature should be obtained from the wider area, not only the linear zone. The chemical analysis will provide specific factors to the problem such as the formation of the contaminant as well as the means of soil circulation is it in the form of underground water, fumes or others. Also Geomembranes and geo synthetic should be used to prevent the migration of fluids from one location to another; for example, lining landfills to stop leachate polluting groundwater, controlling groundwater entering tunnels or creating attenuation ponds within development. The problem analysis should follow two basic directions in the quest for solution: a) remedy of ground characteristics, b) remedy of existing rail superstructure (concrete sleepers and fastening system).

*Keywords: railway infrastructure, higher speed, safety, environment.*

### 1 Executive Summary

As per SRO (Saudi Railway Organization) request, a visit was performed at site at siding 2 and soil samples was taken for chemical analysis, after the soil analysis, a report was issued with various recommendations that could be adopted, such as the placement of water barriers membranes beneath the track bed, the use of sealants to already placed sleepers, the substitution of the corroded sleepers with new sleepers manufactured with a special concrete mix design etc. Due to the quick deterioration in the concrete sleepers, Almobty was requested to provide a solution to the problem for the foregoing areas limited to the use of concrete sleepers with improved quality and enhanced chloride and sulphate resistant properties. Almobty informed SRO that to proceed with the solution a geotechnical study would have to be performed and upon receipt of the investigation report, a special concrete mix design can be provided by the researcher. Almobty conducted a site visit at Siding 2 along with a special third party for geotechnical studies under the supervision of researchers. The railway line of the area in question is about 22 km long. It should be pointed out that all our remarks regarding all site visits with the manifested corrosion problem of the sleepers, are based solely on visual inspection, filed observations and geotechnical studies. Regarding the site visits the following were

observed, all elements of the track line, the sleepers, the fasteners and the rails themselves seem to have been affected by corrosion to a variable extent and thus the sources of corrosive agents must be identified and the causes of corrosion should be safely and reliably concluded based on concrete data gained from field and geotechnical investigation. It is noteworthy that the deterioration of concrete sleepers observed at selected sites present different morphological features, a fact leading us to draw the conclusion that different set of conditions prevail in these different locations and most likely different corrosive mechanisms are accountable for the deterioration of the concrete sleepers. The identified features of deteriorated sleeper elements at the aforementioned sites can be summarized to the followings:

- Quite a few concrete sleepers are marked by fresh open longitudinal cracks which are clearly not associated with the action of any external environmental corrosive factors but are obviously generated by mechanical fatigue and oversteering.
- Concrete sleepers aggressed by corrosion with cracks and spalled off concrete chunks with visible corrosion trace marks of the reinforcement bars presumably by chloride penetration. No visible marks of sulphate attack were seen on the concrete spalls. The most likely source of chlorides it is surmised to be the uprising moisture due to capillary phenomena of a shallow salivated ground water table as it can be concluded from field observations of the broader area. Yet the windblown sand which is in direct contact with the track elements may not be excluded as a possible source of chlorides but this only can be safely indicated by the soil analyses of chemical and mineralogical composition.



**Figure 1** Cracked and Corroded Concrete Sleepers (km 19, 25, 31 & 37)

**Table 1** Existing Mix Design for concrete sleepers

Sulphate Resisting Portland Cement, Class 52.5 N (as per EN 197-1, low alkali (< 0.60%) and C3A < 3.5%).	430 kg
1" Aggregate	252 kg
3/4" Aggregate	360 kg
3/8" Aggregate	360 kg
Washed Sand	576 kg
White Sand	252 kg
Water	170 kg

*\*Source: SRO Sleeper supplier specifications*

The following should be noted:

- Aggregates meets EN 12620
- Water reducing admixture could be used in quantity 4.5 lit/m<sup>3</sup> approximately.
- Tie has been designed as per SRO specification.
- Pre-stressing has been done as per EN 10138.
- Curing in the oven is of high importance and relevant procedure must be followed.

## 2 Geotechnical study

Portland cement when hydrated forms calcium, potassium and sodium hydroxides that are released during the curing reaction providing a high pH environment ( $\approx 12.5$ ) surrounding the steel. At this pH value, the steel is passive and will not corrode unless the passive film is attacked and destroyed. While several factors can cause the disruption of the passive film, chloride ions are one of the most common attacks and are a primary cause of corrosion of steel in concrete. In addition, the presence of carbon dioxide will neutralize the hydroxides, reduce the pH, and cause the corrosion of steel. [1]

### 2.1 Carbon dioxide caused problems

Carbon dioxide will react with the hydroxides in the pore solutions to form carbonates, plus water causing the pH to decrease to about 8.3 and the steel to start corroding. The rate of penetration of the carbon dioxide into the hardened concrete depends upon according [7]:

- The partial pressure of  $\text{CO}_2$ .
- Concrete permeability.
- Cement type.
- Cement content.
- Environmental humidity.

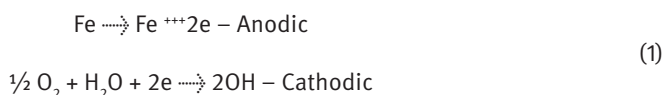
Carbonation caused damage could be prevented by:

- Increasing concrete cover depth over the steel.
- Increasing density of the concrete.
- Using higher amounts of cement in the concrete.

### 2.2 Chloride caused problems

Chloride ions in concrete can be present due to several factors. The main causes can be 1) (the diffusion/penetration through the concrete from surrounding environment, 2) mixing with the concrete inadvertently as part of the water or aggregate, and 3) using additives as calcium chloride which is a set-accelerator. With the presence of chloride ions at the steel level, the passive conditions are disrupted and corrosion can occur. [2]

Steel corrodes by the anodic reaction which involves iron going to the ferrous ion. There must be a simultaneous cathodic reaction and in Portland cement concrete, it is the reduction of oxygen.



Oxygen must be available for the corrosion reaction to proceed. When oxygen is readily available the following factors control the rate of the overall corrosion reaction:

- Chloride concentration.
- Potential profiles.
- Concrete mix characteristics control.

### 2.3 Chloride concentration

The FHWA states that when the chloride concentration in a bridge deck is 0.15% based in cement concrete there is no danger of corrosion at that time and the concrete can be left intact. When concrete contains 0.3% chloride, the concrete below the top mat or the entire deck must be replaced. Report states that it is known that corrosion probably will occur when

the concentration reaches 0.35 – 1% chloride ion by weight based on cement, Table 2. The American Concrete Institute has developed standards on chloride levels permissible in the concrete mix used for various reinforced concrete structures,

**Table 2** Chloride corrosion concentration

Structure	CL – % By weight based on cement weight
Prestressed	0.06%
Reinforced structure wet exposed to CL – in environment	0.10%
Reinforced structure wet no CL – in environment	0.15%
Above ground dry	No limit for corrosion purposes 2% Ca Cl <sub>2</sub> limit for accelerated set

*\*Source: FHWA (Federal Highway Authority USA)*

## 2.4 Potential profiles

The detection of the presence of high potential areas of corroding steel in concrete can be accomplished by measuring the potential of the steel with respect to a reference electrode. The copper/copper sulphate reference electrode (Cu/CuSO<sub>4</sub>) is commonly used.

ASTM standard states that a steel potential numerically greater than -0.35v w.r.t Cu<sub>2</sub>CuSO<sub>4</sub> will have greater than 90% probability of corrosion in that area. A potential that is numerically less than -0.20v w.r.t Cu/CuSO<sub>4</sub> indicates that the steel has a 90% probability to not be in a corroding condition. There is some uncertainty concerning the presence of corrosion when the potential values fall between -0.20v and -0.35v. [8]

The presence of the Chloride ions will force a shift in the electrode potentials from the passive values of +0.100v to -0.100v w.r.t Cu/CuSO<sub>4</sub> to the values that are indicative of active corrosion and that are greater than -0.35v.

Chloride ions penetrate into concrete structures in a non-uniform pattern due to non-uniform contact with the structure and to non-uniform concrete properties. As such, potential mapping of reinforced concrete structures usually results in wide ranges of potential varying greatly between 100 mv and 500 mv across the structure. These potential gradients and differences lead to a galvanic type of accelerated corrosion caused by the appreciable corrosion currents that are developed between the different structural parts with different potentials.

## 2.5 Moisture content

The effect of moisture on the corrosion rate is an indirect one. The corrosion reaction rate is dependent upon the resistivity of the environment surrounding the reinforcing steel. If the resistivity of the environment is high then the corrosion rate will be lower since the current flow will be reduced by the higher circuit resistance. Table 3 lists the resistivity values for concrete with various levels of moisture content. The dry concrete has sufficient resistivity that is capable of preventing corrosion. The corrosion should not be a problem as long as the concrete remains dry.

**Table 3** Resistivity of Concrete

<b>Water saturated</b>	13-15% H <sub>2</sub> O	103 – 104 ohm-cm
<b>Laboratory dry</b>	3-5% H <sub>2</sub> O	105 – 106 ohm-cm
<b>Baked-dry</b>	< 1% H <sub>2</sub> O	108 – 109 ohm-cm

*\*Source: ASTM (American Society for Testing and Materials)*

## 2.6 Concrete mix factors

The concrete mix design has a direct effect on the corrosion damage caused by the diffusion of the chloride ions mainly by limiting the permeability of the concrete mix. The higher the chloride ion permeability the higher the corrosion risk. The major factors that affect the concrete permeability include the water to cement ratio and the cement content in the mix. Concrete mix designs with higher cement contents and lower water cement ratios will be better for resisting damage due to chloride caused corrosion.

The type of cement will also change the corrosive behaviour of embedded steel. As mentioned earlier, chloride ions will react with the tricalcium aluminate (C3A) and will be removed from the pore solution. As such, cements with high C3A contents will provide a more protective environment than cements with lower C3A contents will provide a more protective environment than cements with lower C3A contents. Type 1 cement should protect steel from chloride caused corrosion to a greater extent than type 2 or type 5 cements since the C3A content of type 1 is higher than the other two.

## 2.7 Methodology

The following activities were carried out in this project:

- Visual inspection of damaged and new sleeper.
- Soil sampling from 2m & 5m depth at sleeper sides.
- Soil resistivity measurements were carried out for the soil samples.
- PH and Chloride analysis of the soil samples.
- Dust sampling from the sides and the middle of the sleeper.
- PH and Chloride analysis of the soil samples.
- Potential measurement and potential mapping of the sleeper.
- Comparison of the results with international standards.

## 2.8 Observations

During the course of the work the following was observed:

### 2.8.1 Upon visual inspection

- Concrete damage started at the sides of the sleepers and propagated towards the centre (see fig. 1).
- Sever corrosion is recorded on the anchor plate and nearby rebar's (see fig. 2).

### 2.8.2 Upon sampling

- Filling material (non-shrinkable grout) for the bolts anchor holes was easy to chip.
- The soil around the sleepers was damp (see fig. 2)

### 2.8.3 Upon chemical testing

- Fall of alkalinity from pH 12 to pH 8 at the side of the sleeper. (see table 5)
- Increase of chloride level in the concrete to 0.34% against concrete.
- Stability of the pH at the middle of the sleeper.
- Lower chloride level at the middle of the sleeper.

### 2.8.4 Upon electrical testing

- Potentials >-ve than -550mV where recorded at the sides of the sleeper.
- Potential profile is recorded on the side of the sleeper. (sides strong & middle weak)
- Low soil resistivity is recorded.



**Table 4** Chemical Analysis of soil

Sample ID	PH	Total Chloride as Cl (%)	Total Sulphate as SO <sub>3</sub> (%)
S # 01, km 19, 2 m	8.7	0.11	1.36
S # 02, km 25, 4 m	9.1	0.08	1.53
S # 03, km 31, 3 m	9.9	0.02	0.15
S # 04, km 37, 5 m	8.6	0.01	0.17

**Table 5** Chemical Analysis of concrete

Sample ID	PH	Total Chloride as Cl (%)	Total Sulphate as SO <sub>3</sub> (%)
S # 01, Original Concrete, Shallow, 1 cm	8.8	0.34	0.56
S # 02, Original Concrete, Deep, 2 cm	8.2	0.09	0.54
S # 03, Concrete, Centre 10 mm Deep	12.6	0.12	0.73
S # 04, Concrete, Centre 40 mm Deep	12.3	0.07	0.67

## 2.9 Interpretation

The anchor bolts holes although filled with non-shrinkable grout, provide access to carbon dioxide, Chloride, Humidity and Oxygen. Carbon dioxide and Chlorides will decrease the pH of the concrete porous solution. At decrease pH, rebar's will lose their passivity (Iron oxide film which is stable at pH of +12 will break down at lower pH and expose metal underneath to corrode). This reinforcement corrosion process would result in corrosion products that occupy greater space than the original steel and will apply stress on the concrete causing it to crack and provide further access to salts, carbon dioxide, oxygen and humidity which accelerate the corrosion process. Eventually concrete will spall and integrity will be lost (see table 5).

**Figure 2** Severe corrosion on anchor plate & rebar, on anchor plate

## 3 Conclusions

The following conclusions were derived from geotechnical study;

- Chloride content of the concrete is higher than the permissible levels on the sides of the sleepers while within limits in the centre sections of the sleepers.
- The Alkalinity of the concrete has been reduced.
- The potential mapping exercise has resulted in indicating high risk of corrosion on the sides of the sleepers and the existence of potential gradients on the sides as well.

It is indicative that the deterioration of the concrete of the sleepers is due to electrochemical corrosion of the steel reinforcement. As per the FHWA, when the rebar corrosion is electroche-

mical in nature, cathodic protection is the most effective way to stop the rebar corrosion and concrete deterioration. Concrete is a material which is basically exposed to the environment and can be affected somehow by the following environmental factors:

- Temperature (High, Low, Frost).
- Relative Humidity.
- Humidification – Drying.
- Seawater.
- Winds.
- Precipitation.
- Sea, Coastal, Ocean (Airborne Chlorides).
- Mineral Salts in groundwater and soil.

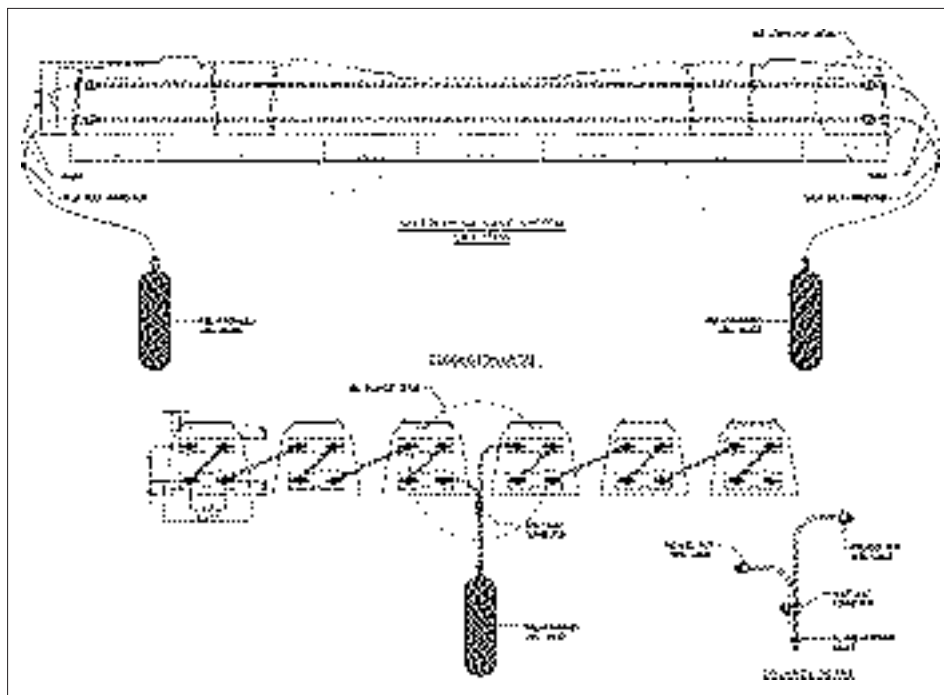
The effect in question probably belongs to either one of the last two categories namely to the occurrence of mineral salts in the groundwater and/or the soil and possibly the airborne chlorides as well due to the proximity of the site to the seacoast. Concrete corrosion provides a high risk of reinforcement corrosion which may affect the durability of any concrete elements, due to the combined action of chlorides and carbonation and affection according to international standards and recommendations. All the aggressions to concrete may induce serious problems and pose high risks to the steel reinforcement and subsequently to the durability of the concrete element and the durability of the concrete sleepers. Apparently the inspected concrete sleepers due to their long time exposure to mineral salts contained either in the groundwater or the soil, have been a subject to serve corrosion and expansion and thereby cracks were generated and developed on them. New Sleepers installed with proposed new mix design and they are continuously in observation from September 2015 as it shown in below pictures (see fig.3).



Figure 3 New Installed concrete sleepers (see table 6 mix design)

## 4 Recommendations

- Use better quality, denser and less permeable repair grout.
- Follow strictly the manufacturer recommendations for the grout application.
- Apply strict quality control on chloride contents of the concrete mix.
- Install Galvanic Cathodic Protection System for the sleepers as per the appended Cathodic Protection system layout, Figure 4.



**Figure 4** Sleepers galvanic system side view (Source: SAF Sleepers / Al-Mobty Company for Contracting)

All visited areas regard to existing railway line in full service. On that account it is recognized that some of our proposed recommendations cited in initial report that we presented to the client such as the placement geotextile beneath the track bed and the use of sealants to already placed sleepers may be practically infeasible to be implemented, due to inadequate line blockage. So the solution to the problem for the foregoing areas should be sought and limited to the use of concrete sleepers with improved quality and enhanced chloride and sulphates resistant properties (see Table 6). Based on the above our recommendations for the mix design for aggression resistant sleepers is as follows:

**Table 6** Recommended mix design for concrete sleepers

Design – C 65 Type V (SRC)		Design – C 65 Type V (SRC)	
Cement Type – V	480.0 kg	White Sand (50%)	311.1 kg
1" Coarse Aggregate (32%)	352.2 kg	Water	181.8 kg
3/4" Coarse Aggregate (35%)	385.2 kg	Admixture – Sika (Viscocrete 20HE)	4.80 Ltr.
3/8" Coarse Aggregate (33%)	363.2 kg		
Washed Sand (50%)	311.1 kg		

*\*Source: SAF Sleepers / Al-Mobty Company for Contracting*

**Note:**

- 1) Weight of Coarse, Fine Aggregate and Water to be adjusted during batching for moisture.
- 2) To reduce the water and to improve the compressive strength, M/s. Sika product Sika (Viscocrete 20HE) can be added in a mix @ 1.0 liter 100Kg of cement

Also geotextile/geosynthetic can be an alternative solution for the remedy of corroded concrete sleepers, geotextile has been utilized widely around the world in for soil insulation and facilitation of drainage. The international experience allows us to define exact specifications on the insulation demands, load bearing capacities, performance in specific maintenance activities such as tamping and ballast cleaning. All the above mentioned requirements are well within the specifications of modern materials. In general, excess or uncontrolled water within soils can weaken them, causing numerous problems. The Management of water behind retaining walls and civil engineering structures, beneath railways, inside tunnels or within slopes, is one of the most important aspects influencing the long term performance of the structure, especially in railways action must be taken.

- Separation and filtering of two distinct soils or layers and preventing cross-contamination
- Protecting membranes or other vulnerable structures
- Improving the bearing capacity of weak soils.
- As is in our case, it can prevent the infiltration of salty soil moisture in the rail structure.

There are a wide range of products that is supported by several manufactures/firms capability to develop and produce specific textiles to suit individual projects and needs.

**References**

- [1] Kerr, A. D.: Fundamentals of Railway Track Engineering, Simmons-Boardman Books, Inc, 2003.
- [2] Gustafson, R.: Static and Dynamic Finite Element Analyses of Concrete Sleepers, MS. C. Thesis, Chalmers University of Technology, 2002.
- [3] Zakeri, J.A., Xia, H., Fan, J.J.: Dynamic Behavior of High-Speed Railway Tracks, Proceedings of the Second International Conference on Traffic and Transportation Studies, Northern Jiaotong University, 2000.
- [4] Zakeri, J.A.: Effective Factors on Failures of Concrete Sleepers, CD-Proceedings of 8th International conference on Railway Engineering, London, 2007.
- [5] High Speed Manual of SRO 2012
- [6] Way and Works Manual SRO 1982
- [7] FHWA (Federal Highway Authority USA)
- [8] ASTM (American Society for Testing and Materials)
- [9] SAF Sleepers / Al-Mobty Company for Contracting





## VERIFICATION AND OPTIMIZATION OF TRANSITION AREAS OF BALLASTLESS TRACK IN THE TUNNEL TURECKÝ VRCH

Libor Ižvolt, Michal Šmalo

*University of Žilina, Faculty of Civil Engineering, Slovak Republic*

### Abstract

The modernization of the railway infrastructure of the Slovak Republic is an ideal opportunity for verifying the applications of unconventional structures of the railway superstructure. The Department of Railway Engineering and Track Management, Faculty of Civil Engineering, University of Žilina monitors geometric parameters of experimental railway track sections in the vicinity of the portals of the tunnel Turecký vrch – sections of ballastless track Rheda<sup>®</sup> 2000, transition areas and sections of ballasted track. The preliminary results of research and experience of the infra-structure manager show that the most problematic parts of track sections are the transition areas between ballastless and ballasted track. The paper deals with the results of monitoring of the track geometry by the measuring trolley KRAB<sup>TM</sup>–Light.

### 1 Introduction

The ballasted track superstructure is made up of rails, supporting points (sleepers), rail fastenings and rail (ballast) bed. The superstructure where the ballast function is replaced by improved materials is called ballastless track. The ballastless track has been reported as a practical and convenient structural system which resulted in its occurrence all over the world. An important reason for building ballastless tracks is the fact that by its establishment we achieve high track stability resulting in high driving comfort for passengers and lower requirements for track maintenance, possessions and financial costs.

In general, the ballastless structure is currently applied mainly in high speed lines and lines that have high line tonnage and where the costs of maintaining ballasted track grow rapidly. Furthermore, this structure becomes more common in upgraded sections of standard tracks (track speed up to 160 km/h), or high speed tracks (track speed  $160 \text{ km/h} < V \leq 200 \text{ km/h}$ ) and mainly in the sections routed in tunnels as in these sections the subgrade properties are favourable, i.e. no settlement of foundations occurs. Besides this, ballastless track application has a positive impact on financial costs for tunnel construction, due to the smaller net tunnel cross section in case of new tunnels or excluding economically demanding reconstruction of the tunnel in case of its electrification on existing tracks. The application of ballastless structure is also possible in track sections routed on bridges due to subgrade with no settlement of foundations [1].

In the Slovak Railways network the ballastless track is currently designed and built on upgraded sections of railway tracks – as a priority in tunnels and on bridges (Fig. 1) [2]. The Department of Railway Engineering and Track Management has been involved in the diagnostics of track geometry for ballastless structure in the area of portals of the newly built tunnel Turecký vrch and after more than ten years after finishing monitoring of the prototype of ballastless structure in Lietavská Lúčka they turn their focus on the issue of ballastless track superstructure.



Figure 1 The ballastless track sections in the railway infrastructure of the Slovak Republic

## 2 Characteristics of the experimental section

The experimental section is situated in the vicinity of the portals of the newly built tunnel Turecký vrch. This track is a part of V. multimodal transport corridor TNT-T, so called Baltic-Adriatic corridor Venezia – Terst/Koper – Ljubljana – Budapest – Užhorod – Lvov with the branch Va Bratislava – Žilina – Užhorod. The ballastless structure (system Rheda 2000®) was built within modernisation of the railway rack Nové Mesto nad Váhom – Púchov, km 100.500 – 159.100, object 24-32-01 Nové Mesto nad Váhom – Trenčianske Bohuslavice [1].

The ballastless structure passes through different types of subgrade. It starts on earthwork at the south portal and is routed through the tunnel. At the north portal the ballastless structure continues on two bridges and earthwork. The total length of the ballastless track is 2 280.145 m. The end of the ballastless structure and the transition to the ballasted structure is carried out by a new type of transition area using standard superstructure components. The structure consists of a longitudinal concrete bed, 20 m long. Each rail has its own concrete bed and the beds are longitudinally dilated. The railbed thickness under sleepers is decreasing in the direction to the ballastless track which causes the increase of the subgrade stiffness. The bed bottom and walls are lined with elastic anti-vibration rubber mats that are supposed to simulate the earthwork soil deformation properties.

## 3 Methods of diagnostics of track geometry

The diagnostics of the track geometry is carried out by the measuring trolley KRAB™–Light [3], [4]. The measuring system measures the track parameters in an unloaded state. The measured parameters are:

- gauge tolerance RK (after calculating the change of gauge ZR is also recorded),
- alignment of right rail SR (after calculating the alignment of left rail SL is also recorded),
- rail top level of right rail VR (after calculating the rail top level of left rail VL is also recorded),
- cant PK,
- quasi-twist on a short base (calculated to a quasi-twist on a base of 1.8 m long – ZK 1.8, 6.0 m long – ZK 6.0 and 12.0 m long – ZK 12.0).

## 4 Assessment of results of track geometry diagnostics

The results of diagnostics are evaluated in accordance with valid technical ŽSR standards and regulations:

- STN 73 6360, Geometrical Position and Arrangement of 1 435 mm Gauge Railways, SÚTN Bratislava, 1999 and Amendment 1, SÚTN Bratislava, 2002 for track speeds of 120 km/h < V ≤ 160 km/h (velocity zone No. 4 – RP4) [3],
- ŽSR SR regulation 103-7 (S) Measurement and Evaluation of Track Geometry by Measuring Trolley KRAB (in Slovak), GR ZSR, (2008) [4].

The experimental sections are for the sake of diagnostics marked as:

- section 1.1 (track No. 1, south portal) and 2.1 (track No. 2, south portal); both sections of length 175 m; km 102.360 000 – km 102.535 000):
  - km 102.360 000 – km 102.460 500 ballasted track,
  - km 102.460 500 – km 102.480 500 transition area,
  - km 102.480 500 – km 102.535 000 ballastless track.
- section 1.2 (track No. 1, north portal) and 2.2 (track No. 2, north portal); both sectors of length 640 m; km 104.200 000 – km 104.840 000):
  - km 104.200 000 – km 104.720 500 ballastless track,
  - km 104.720 500 – km 104.480 500 transition area,
  - km 104.740 500 – km 104.840 000 ballasted track.

The diagnostics of the track geometry was carried out on semi-annual basis as [5]:

- measurements before putting sections into operation (MSO) 10. – 11.7.2012, 2. – 3.10.2012,
- first operational measurement (PO1) 09.04. – 10.04.2013, 21.04 – 22.04.2013,
- second operational measurement (PO2) 08. – 09.10.2013, 21. – 22.10.2013,
- third operational measurement (PO3) 25.5.2014 and 28.5.2014,
- fourth operational measurement (PO4) 29.10.2014.
- fifth operational measurement (PO5) 25.3.2015 and 17.4.2015.
- sixth operational measurement (PO6) 14. – 15.10.2015.

The measured parameters are evaluated according to the maximum input tolerance for acceptance of works with the use of new material (MSO), or according to operational tolerances and limit operational tolerances for RP4 (Table 1). The overall super evaluation of the test sections is given by:

- the quality number of the section (SQM) of each parameter (SK, RK, PK, VK),
- the quality mark (QM), as an assessment of a track geometry quality in the evaluated section,
- the tamping mark (TM), which is used to decide whether to use the tamping machine and varies from SQN by excluding the gauge tolerances (RK) which tamping machine does not maintain,
- the quality number (QN).

The section evaluation is carried out according to [4] using:

- the quality number of the evaluated section, which is used to assess the quality of track geometry and is calculated from the standard tolerances of the measured parameters of the evaluated section (SK, RK, PK, VK); to evaluate the quality of track geometry are set recommended standard tolerances values of each parameter and quality number values for RP4 are listed in Table 2,
- the quality marks of each parameter (SK, RK, PK, VK); the results of evaluation by the quality marks are indicative and additional and are not binding for the evaluation of track geometry; assessments that are defined at various intervals of the quality marks are only recommended (Table 3).



**Table 1** The tolerances of relative geometric parameters of the track for RP4 [3]

Measured parameter	Limit input tolerances		Operational tolerances		Limit operational tolerances		Note
RK (mm)	-2	2	-3	5	-5	10	–
ZR (mm/m)	2		3		4		–
PK (mm)	-3	3	-6	6	-8	8	–
Measured parameter	Limit value		Operational value		Limit operational value		Note
ZK (1:n) (mm/base)	1:250 (7.2; 4.0)		1:250 (7.2; 4.0)		1:167 (10.8; 5.99)		on measuring base 1.8 m
	1:832 (7.2; 1.20)		not evaluated		1:250 (24.0; 4.0)		on measuring base 6.0 m
	not evaluated		not evaluated		1:333 (36.0; 3.0)		on measuring base 12.0 m
Measured parameter	Limit input relative tolerances		Relative operational tolerances		Limit operational relative tolerances		Note
VL, VP (mm)	-3	3	-6	6	-8	8	–
SL, SP (mm)	-3	3	-6	6	-8	8	–

**Table 2** The limit values of respective tolerances of geometric quantities (SDV) and quality numbers (CK) for RP4 [4]

Limit input tolerances				Limit operational tolerances			
SDV <sub>SK</sub>	SDV <sub>RK</sub>	SDV <sub>PK</sub>	SDV <sub>VK</sub>	SDV <sub>SK</sub>	SDV <sub>RK</sub>	SDV <sub>PK</sub>	SDV <sub>VK</sub>
0.7	0.8	0.7	0.8	0.9	1.0	1.1	1.5
QN				QN			
1.8				2.5			

**Table 3** The scale of quality marks according to quality section evaluation [4]

Interval of quality marks	Verbal assessment of the section according to the quality mark	Color of the quality mark in printed output
$0 < QM \leq 2$	the state of track geometry is satisfactory in the section evaluated	no color marking
$2 < QM \leq 3$	it is recommended to design the repair of track geometry in the section evaluated in the maintenance work plan	green color
$3 < QM < 4$	it is recommended to perform the repair of the track geometry in the section evaluated before the nearest inspection	violet color
$4 \leq QM \leq 6$	it is recommended to perform immediate measures in the section evaluated to ensure the safety of operation	red color

## 5 Quality assessment of diagnosed sections

The quality development of the track geometry quality diagnosed by the measuring trolley KRAB™–Light is shown by Fig. 2 to Fig. 6. The evaluation of tolerances of track geometry in RP4 includes evaluation of straight track, track in curve or in transition curve. As a part of the input measurement (MSO), 40 local errors were found, 30 of them in the section with ballasted track, 9 in the section with ballastless track and 1 in the transition area in the south portal area (rail no. 2). After this measurement, the contractor carried out the repair of track geometry and the repair of microgeometry of rail heads by grinding in the diagnosed sections. Unfortunately, the contractor did not provide the details of this intervention. In the second operational measurement (PO2) there were for the first time diagnosed local errors of alignment of right (VP) and left rail (VL) in the transition area of the south portal (rail no.1) that confirm the results of the measurements by measuring vehicle of ŽSR. In the following measurements – in the third and fourth operational measurement (PO3 and PO4), further quality degradation of this track section was diagnosed, confirmed by the increased number of local errors and lower value of quality number (Fig. 2). In November 2014, there were done maintenance interventions in transition areas near south portal. The interventions also significantly decreased the value of quality numbers of sections, from the value 2.36 (PO4) to the value 1.31 (PO5) in the section 1.1 and from the value 1.86 (PO4) to the value 1.59 (PO5) in the section 2.1. The levelling in both transition areas of the south portal (sections 1.1 and 2.1) from December 2014 to August 2015 showed further decline in vertical alignment of the track. With regard to their size these values cannot be at present considered as local errors but in relation to qualitative decrease of other parameters of sections, incidence of local errors can be expected in the near future. The transition sections of the north portal do not show any decrease of these values and the trends based on measurements do not indicate probability of their incidence in further measurements [5].

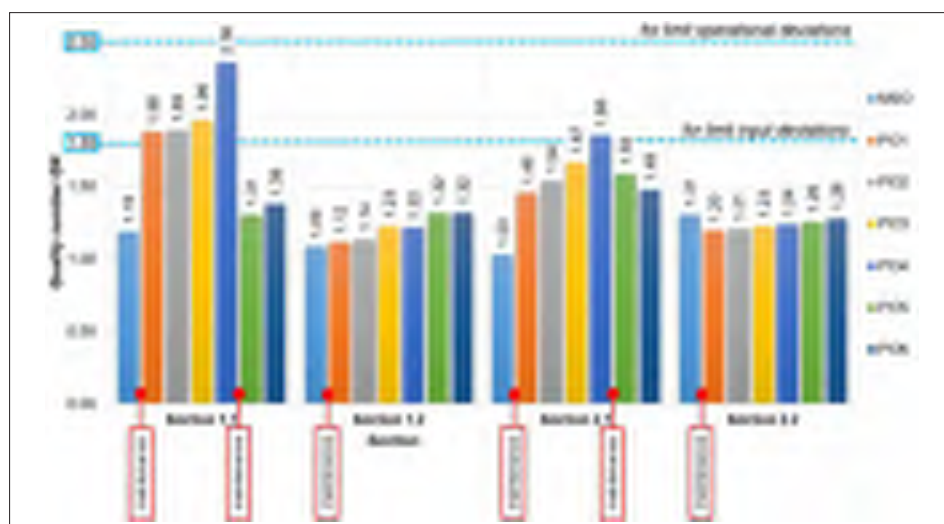


Figure 2 Overall quality numbers in the monitored sections

The quality marks of alignment of right (after calculation also left) rail  $QM_{SK}$  (Fig. 3) were in the input (MSO), first (PO1), second (PO2) and third operational measurement (PO3) in the interval  $2 < QM_{SK} \leq 3$ . The quality marks in the interval  $3 < QM_{SK} \leq 4$  were achieved in the sections 1.1 and 2.1 (both rails of the south portal) in the fourth operational measurement (PO4). After interventions the values of quality marks decreased to the interval  $0 < QM_{SK} \leq 2$  in the section 1.1 (rail no. 1, south portal), or  $2 < QM_{SK} \leq 3$  in the section 2.1 (rail no. 2, south portal).

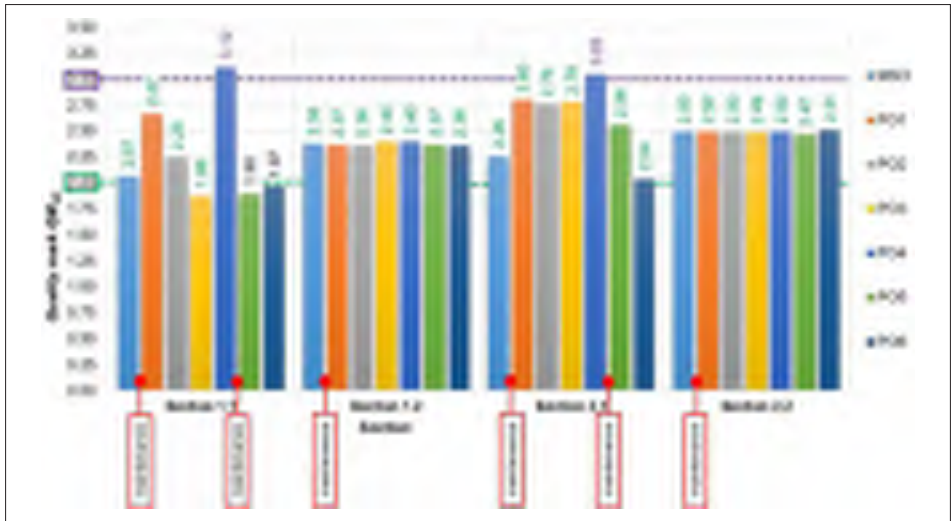


Figure 3 Quality marks of track alignment in the monitored sections

The quality marks of gauge tolerance in all the sections and measurements were in the value interval  $0 < QM_{RK} \leq 2$  (Fig. 4). The higher values of quality marks  $QM_{RK}$  of sections 1.1 and 2.1 are related to the higher share of sections with ballasted track compared to the sections in the north portal area where ballastless construction is prevailing. It fixes gauge in much better quality than ballasted track.

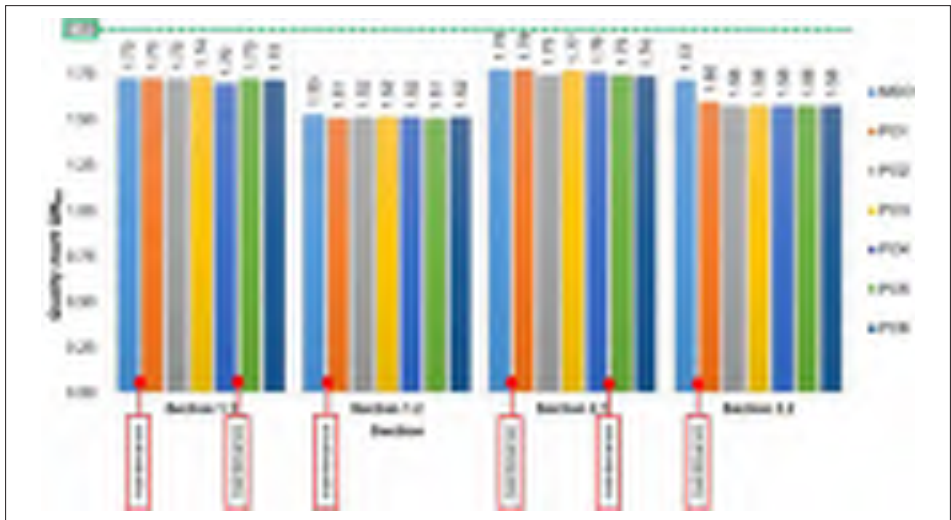


Figure 4 Quality marks of gauge in the monitored sections

The quality marks of cant  $QM_{PK}$  are in the value intervals  $0 < QM_{PK} \leq 2$  and  $2 < QM_{PK} \leq 3$  in the second, third and fourth operational measurement (PO2, PO3 and PO4) in the section (rail no. 1 at the south tunnel portal). After corrective interventions the values got back to the interval  $0 < QM_{PK} \leq 2$ . The increasing trend of quality mark of cant  $QM_{PK}$  in this section indicates that in one of the following measurements the value will again reach the interval  $2 < QM_{PK} \leq 3$  (Fig. 5).

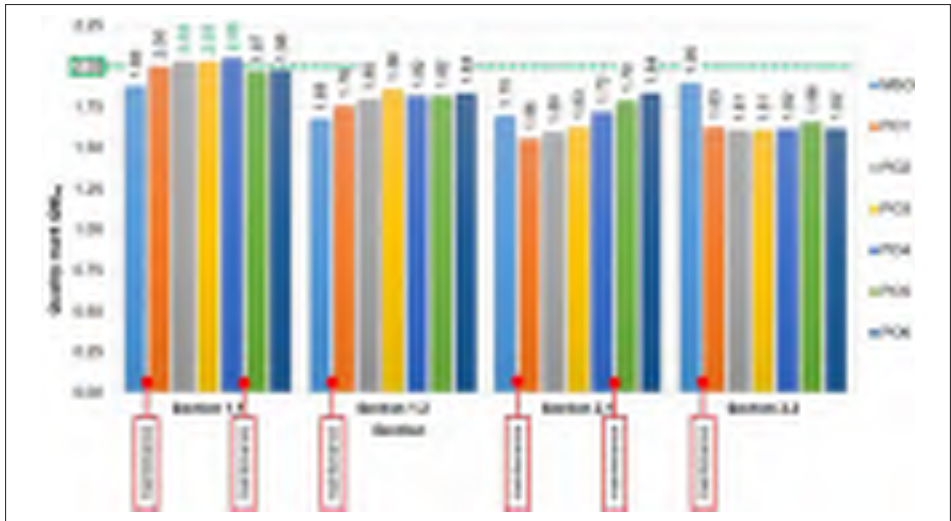


Figure 5 Quality marks of cant in the monitored sections

The worst quality mark, based on so far carried out measurements, seems to be the quality mark of rail top level of the right (after calculation also the left) rail  $QM_{VK}$  (Fig. 6). The defects of rail top level tolerance of rail are the most frequently occurring defects resulting from the evaluation of measurements by the measuring vehicle ŽSR. With the exception of the section 2.1 (rail no. 2 in the south portal), in all the sections and measurements there were reached values  $2 < QM_{VK} \leq 3$  and values  $3 < QM_{VK} < 4$  in the first to fourth operational measurement (PO1 to PO4). The corrective intervention carried out before the fifth operational measurement (PO5) decreased the values of quality marks  $QM_{VK}$  that were in the fifth and sixth operational measurement (PO5, PO6) again in the interval  $2 < QM_{VK} \leq 3$ . The growing trend indicates that in the following measurements the quality mark of value  $QM_{VK}$  in the interval  $3 < QM_{VK} < 4$  can be achieved.

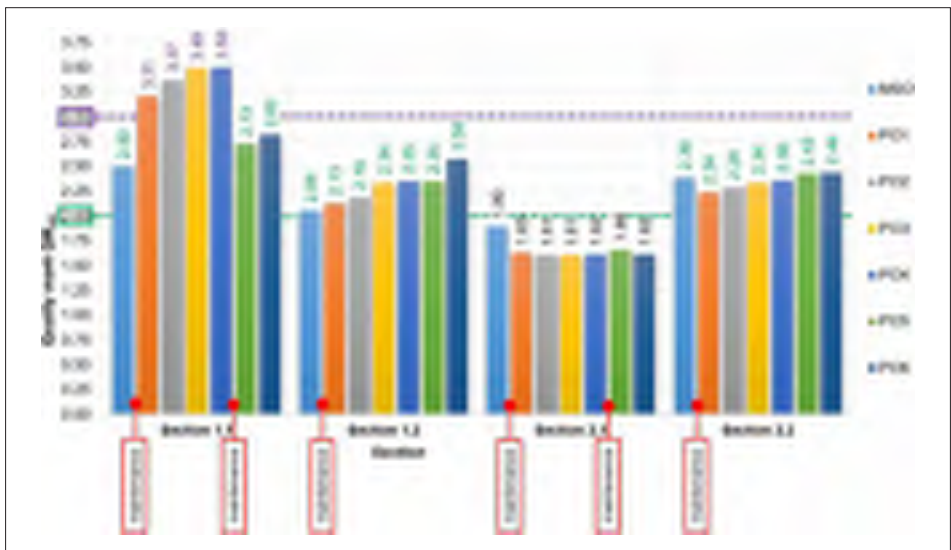


Figure 6 Quality marks of rail top level of right rail in the monitored sections

## 6 Conclusion

The results show that the critical point of ballastless sections are the transition areas from this type of construction to the ballasted superstructure. The current problem in this field is optimization of design of transition areas. Its solution can be found important by infrastructure operators in relation to corridor track modernisation where construction of more ballastless sections is planned. The paper contains results of the grant VEGA 1/0597/14 “Analysis of methods used to measure the unconventional railway track construction from the point of view of accuracy and reliability”.

## References

- [1] Ižvoltová, J., Pisca, P., Villim, A., Mancovič, M.: Precision Analysis of Height Measurements Realized on Ballastless Track, Communications: Scientific Letters of the University of Zilina, 16, pp. 63-67, 2014.
- [2] Šestáková, J.: Quality of Slab Track Construction – Track Alignment and Track Geometry, Civil and Environmental Engineering, 1, pp. 2-9, 2015.
- [3] STN 73 6360. Track Alignment Design and Track Geometry of Normal-gauge Tracks and Amendment – part 1, 1999.
- [4] ZSR SR 103-7 (S). Measurement and Evaluation of Track Geometry by Measuring Trolley KRAB, 2008.
- [5] Šestáková, J., Mečár, M.: Evaluation of Track Design and Track Geometry of the Track with Unconventional Structure of Railway Superstructure, Proceedia Engineering, 111, pp. 709-716, 2015.



## ANALYSIS OF THE CRANE RAIL TRACKS OF BULK CARGO TERMINAL AT THE PORT OF PLOČE

Stjepan Lakušić<sup>1</sup>, Darko Badovinac<sup>2</sup>, Viktorija Grgić<sup>1</sup>

<sup>1</sup> University of Zagreb, Faculty of Civil Engineering, Zagreb, Croatia

<sup>2</sup> Viadukt d.d., Zagreb, Croatia

### Abstract

The Port of Ploče is located on the eastern coast of the Adriatic Sea and is due to its location of great importance for the economy of Croatia and neighboring countries. Bulk cargo terminal in the port of Ploče, within which the project of crane tracks is included, is a part of a broader project development of the port of Ploče and the Gateway Corridor VC, which in the future should be an important connection of Middle Europe, Croatia and BiH. This paper presents an overview of the technical and construction characteristics of the chosen solutions for the crane rail tracks that are part of Bulk cargo terminal in the Port of Ploče.

*Keywords: crane rail track, Port of Ploče, crane design, bulk cargo terminal*

### 1 Introduction

Crane track structures present a special application of railway engineering that traditionally finds its place between the disciplines civil engineering and mechanical engineering. That is because the crane track is strongly related to the type of crane that will use the track. Crane tracks are rail tracks on which cranes and all sorts of transshipment machines ride with wheel load of 200-1000 kN and speeds of up to 150 m/min. Those may be fully or partly embedded in the supporting structure which can exist of wooden sleepers, heavy I-beams, or a concrete foundation. The permitted tolerances for cranes in operation are of major importance and are strictly regulated [1]. The specific qualities of the crane rail track will be described on the example of the Port of Ploče.



Figure 1 The geographical position of the Port of Ploče [2]

The Port of Ploče is located on the eastern coast of the Adriatic Sea and is due to its location of great importance for the economy of neighboring countries, such as Bosnia and Herzegovina (the border is 25 km from the Port of Ploče), Serbia, Montenegro, Hungary. The geographical position of the Port of Ploče enables very good maritime connection with the cities on the

Croatian Adriatic coast, Italy, and with the ports of the entire world. The Figure 1 shows the geographical position of the Port of Ploče [2]. Subject of this article is the design and construction of crane tracks which are located at the center of the open storage area.

## 2 General information

Bulk cargo terminal at the port of Ploče, within which the project of crane tracks is included, is a part of a broader development project of the port of Ploče and the transport Corridor VC, which in the future should be an important connection of Central Europe to Croatia and Bosnia and Herzegovina. Part of the broader project was completed earlier, i.e. Ploče Container Terminal which was completed and commissioned during 2011. Project for construction of Ploče Bulk Cargo Terminal is financed by the government of the Republic of Croatia from the state budget and through a credit granted by the World Bank (IBRD) through the Investor, Ploče Port Authority. Work on the entry terminal of the Ploče port is also in progress and it is within the framework of the same credit facility.

Construction of the bulk cargo terminal is divided into two stages, and the Main Project envisages that infrastructure works (construction of storage and handling areas, new railway tracks and roads, deepening of the channels and the access channel, construction of a dock on steel pylons, construction of administrative building and workshop and other infrastructure works which include cable distribution, drainage and water supply) and installation of technical equipment for transshipment of 3,000,000 tons of bulk cargo, which is an obligation for the future concessionaire – Luka Ploče d.d. shall be done in the first stage. The second phase of the Port of Ploče development strategy is to increase the port capacity to about 4600000 tons of bulk cargo.

## 3 Characteristics of foundation and crane tracks

### 3.1 Geotechnical conditions

The soil at the site of the crane rails consists of soft marine sediments and is unfavorable geotechnical environment. The characteristics of the soil at the construction area were investigated through several tests. Due to poor characteristics of the soil, it was necessary to implement its stabilization [3, 4]. Figure 2 shows the layout of the part of the area covered by the Port of Ploče with designated positions of crane tracks CP-101 and CV-201.

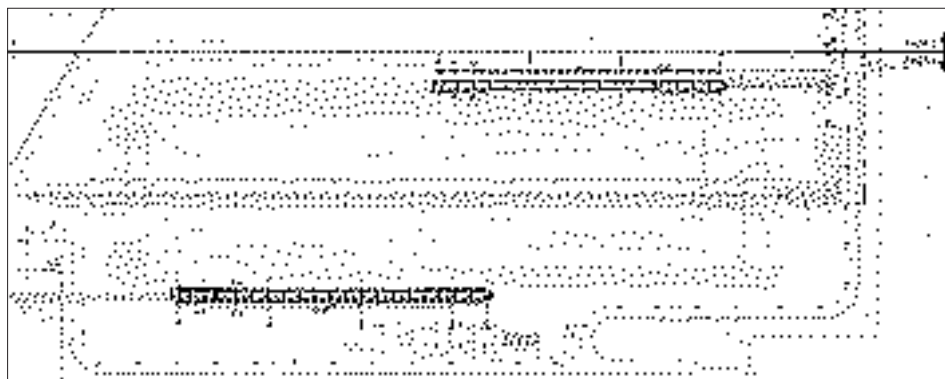


Figure 2 Layout of handling equipment

### 3.2 Foundation design

For two crane rail tracks, CP-101 and CV-201, concrete foundation was designed, while the foundation for crane track CV-103 was already made and the track structure was designed. Length of the crane track CV 201 is 237 m, length of the crane track CP 101 is 217.12 m and the length of the crane track CV 103 is 516 m. Figures 3 and 4 show input parameters used for the crane track design for tracks CV-103, CP-101 and CV-201.

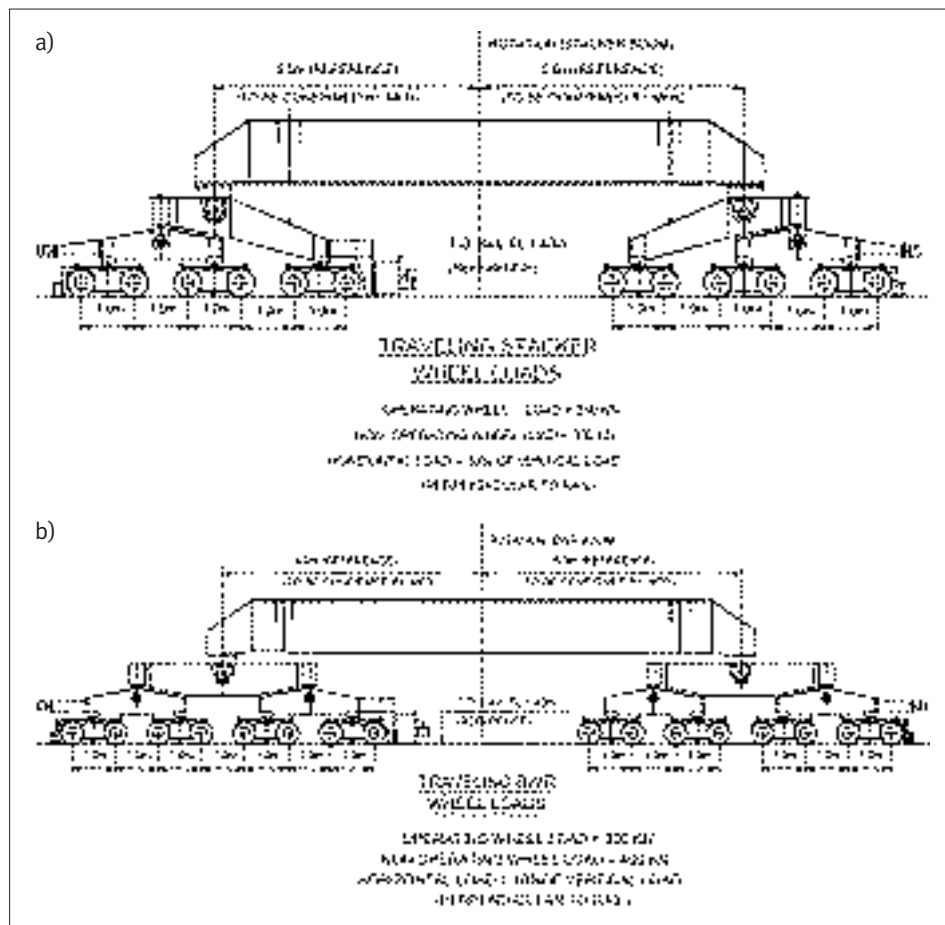


Figure 3 Load diagram on the crane track CV 103: a) Vehicle no. 1, b) Vehicle no. 2



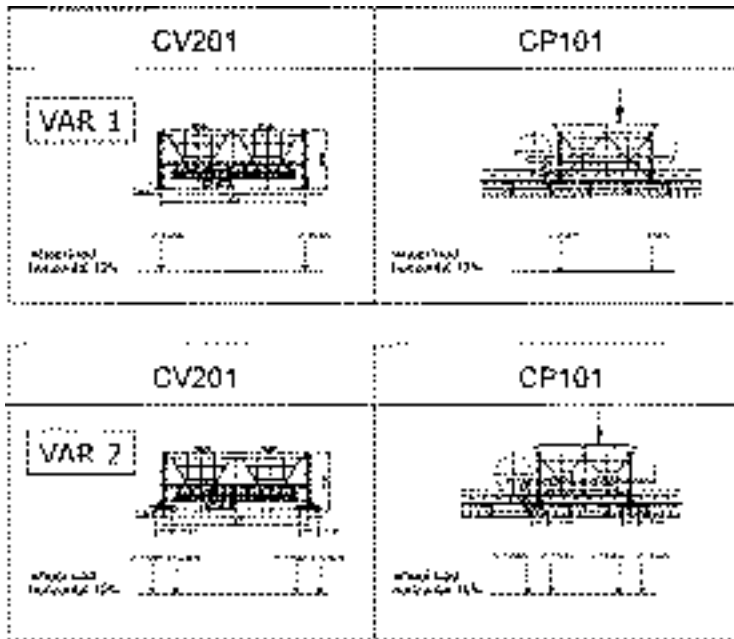


Figure 4 Load diagram for version 1 and version 2 on crane tracks CV-201 i CP-101

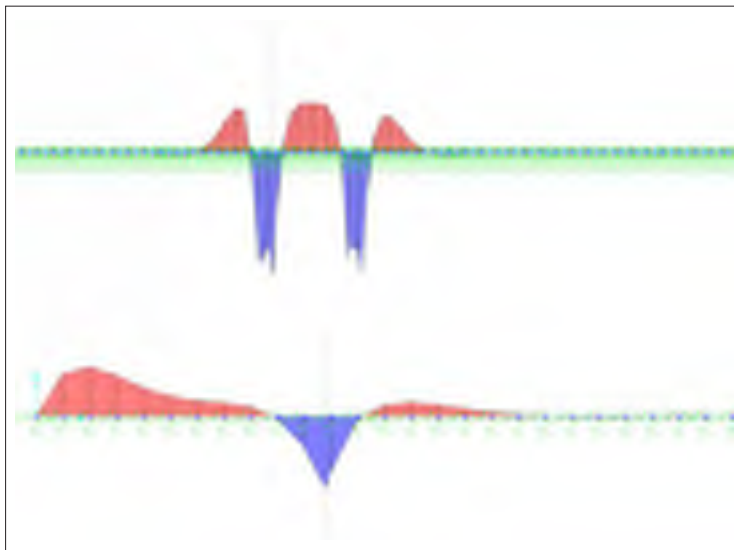


Figure 5 Moment diagrams for the crane track CV-201, SAP2000 [3]

Foundation for the crane rail tracks CP-101 and CV-201 has been sized based on these loads and the given load-bearing capacity of the base which were taken from the geotechnical project ([4]). Strip foundations of the crane tracks are made of concrete, with rectangular cross-section with a width of 90 cm and height of 60 cm, with a protective layer of concrete 5 cm thick, in accordance with the environmental conditions in the area in which the structure is located. Specified concrete class is C 30/37 and each track consists of two foundations, which

is defined by the shape of the crane (hopper) which moves along the structure. Considering the shape and spacing of the hopper wheels, axial distance between the foundations is 60 cm. Additionally, the foundations are made to act compositely by 40 x 40 cm AB beams, with an axial distance between them of 12 m, [3]. Figure 7 shows the reinforcement installed in the foundation tracks.

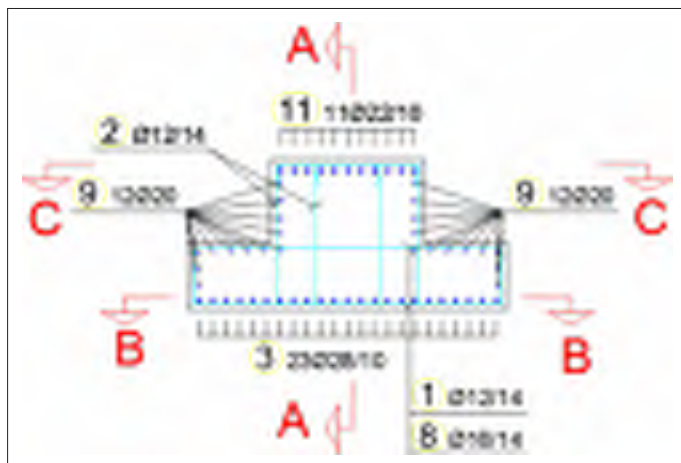


Figure 6 Cross-section of the crane track foundation with reinforcement [3]



Figure 7 Placed reinforcement of strip foundations and transversal beam

### 3.3 Crane track design

#### 3.3.1 Crane tracks CP-101 and CV-201

Based on the geometry, environmental restrictions and relevant loading variants (VAR 1, VAR 2), the following parameters were designed: reinforced concrete foundation, rail, steel soleplate, anchors, clips, elastic pads. Considering the scope of design services, for movement on the CV-201 and CP-101 crane tracks, a type A100 (74,3 kg/m<sup>3</sup>) rail was chosen, which is placed on the steel plate to which it is attached by “Gantrex” 21/08/BK fastening clip.

Thickness, type and steel plate spacing are chosen for given crane loads and type of rail, in accordance with the characteristics of the elements of the manufacturer Gantrex. Steel plates are 2980 mm long, 20 mm thick, while the weight of these plates enables easier handling at the construction site. Steel soleplates can be continuous or intermittent depending on the requirements of the system. In this case, on the project of the Bulk cargo terminal in the Port of Ploče, according to designed loads and operating conditions, the rail is continuously supported by the steel soleplates. The continuous support is achieved by soleplates with

dimensions: 2980x372x20 mm, steel R235, while the distance between every soleplate is 20 mm, because of the possible thermal loads. Continuous soleplates are used for heavy-duty rail systems with high loads and high cycle rates. GANTREX elastic pad with a width of 200 mm is located between the steel plate and the rail foot. Steel plate on which the tracks are positioned is connected to the AB base strip by galvanized steel screws which were precisely placed within the reinforcement cage of the strip foundation. Nuts are screwed on the steel screws on which a steel plate is placed which is tightened with a long screw, which enables accurate height adjustment of the steel plate on which the tracks will later be laid. Entire screw installation process was geodetically established and checked before and after placing the concrete in the strip foundation. Figure 8 shows a detail of CP-101 and CV-201 fastening.

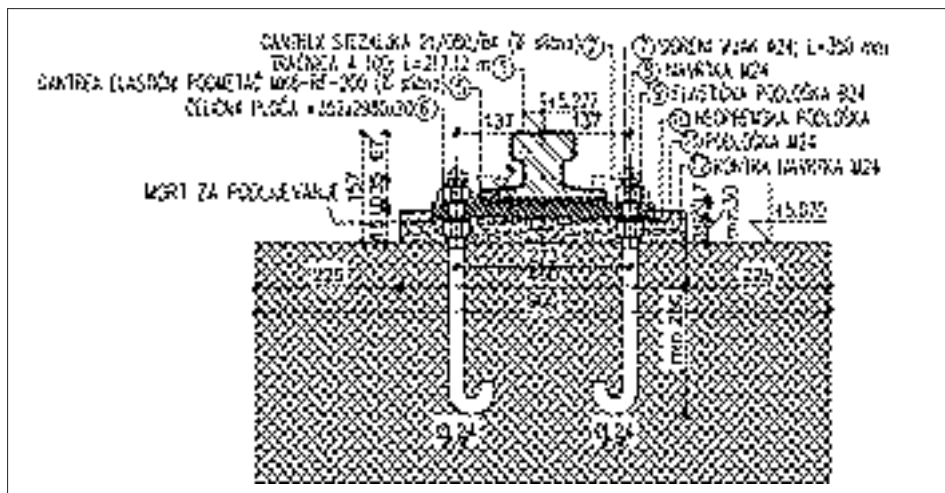


Figure 8 Fastening detail for CP-101 and CV-201 [3]

### 3.3.2 Crane track CV-103

Unlike the foundations for the movement of stacker/reclaimer (CV-103) along the centre of the storage area, which is built within the scope of existing civil engineering project (the original one) for the movement of the stacker/reclaimer machine AB crane tracks of reverse “T” cross-section (Figure 9).

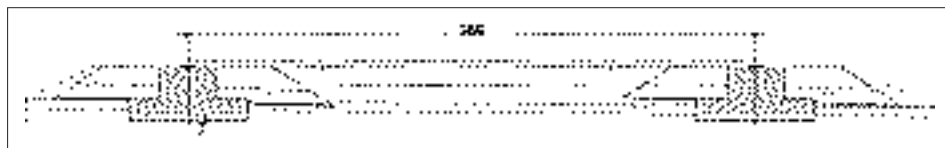


Figure 9 Layout of the crane track foundation

Considering the fact that at the time of when the main design was being elaborated, the concessionaire did not have information on the equipment which will be installed, placement of tracks for stacker/reclaimer movement was not envisaged. Due to this, anchors for rail fastening were not placed when the concrete was laid. Only after the works were performed, the concessionaire (their consultants) delivered the data for rail track calculation.

Type A120 (100,00 kg/m<sup>2</sup>) rail was selected as a rail which meets the set requirements, which is placed on the steel plate to which it is fastened with the “Gantrex” B15/CJ fastening clip.

Between the steel plate and the rail foot there is a GANTREX elastic pad with a width of 220 mm. Since AB foundations were constructed earlier and anchoring bolts for the steel plate were not previously installed, it was necessary to drill a hole with a diameter of 32 mm for each anchor bolt, in which a galvanized steel screw with a diameter of 24 mm was installed by using the injection cement mortar.

Considering the very large loads and consequently large quantities of tightly placed reinforcement within concrete cross-section, anchor bolt arrangement was chosen which minimizes the possibility of cutting the reinforcement when drilling the holes. However, due to the fact that the installed reinforcement is pretty tightly placed, and that there are certain position tolerances at installation of reinforcement, of load-bearing capacity of crane rails for unfavorable case of cutting of reinforcement was calculated. The calculation showed that the load-bearing capacity of the crane rail for specified stacker/reclaimer device is satisfactory in the event of cutting through the reinforcement.

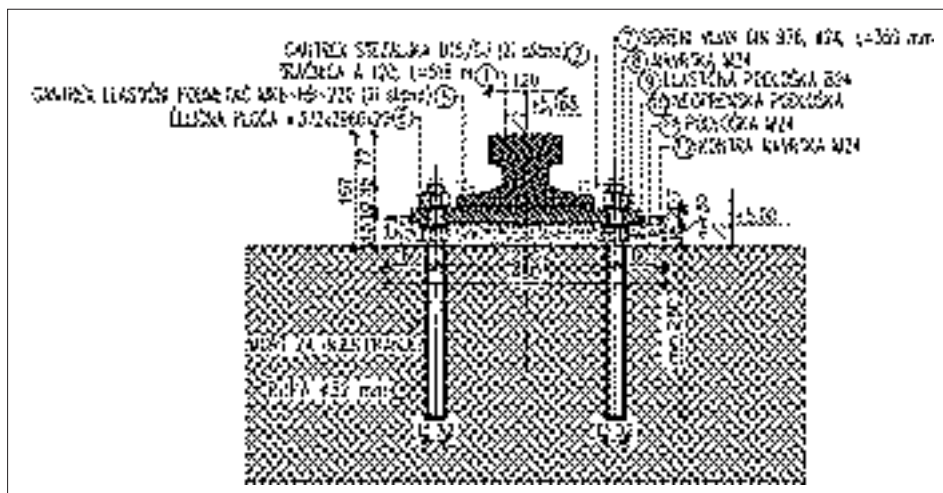


Figure 10 Detail of the fastening of the rail track crane structure CV-103 [3]

## 4 Building of the crane tracks

### 4.1 Crane tracks CP-101 and CV-201

During construction, the works have been carried out in the following order: firstly steel anchor bolts were placed in accordance with the design layout, for which tin installation patterns were used in which anchor bolts ( $\Phi$  24 mm) were placed and then fastened to the pattern with the anchors after which such assembly was placed in the reinforcement cage and geodetic control was performed. After the concrete in the strip foundation has hardened and surface was cleaned, detailed levelling of the steel plate for the purpose of placement of track was performed. Steel plates with the dimensions of 2980x372x20 mm, R235 steel quality are placed on them. Bottom nuts of the steel plate are then used to finely adjust the height with geodetic monitoring. After it is established that the plate is at a designated height, such plate is then fastened from the top side by the second nut and Gantrex 21/080/BK [6] clips are welded. On places steel plates (levelled by height) an elastic pad is placed, on which the tracks are positioned, Figure 12 (figure pertains to CV-103 but the principle is the same for CP-101 i CV-201). Finally, continuous bearing is placed underneath the steel plate. Rails are welded in a continuous welded rail (CWR) by manual metal arc welding (MMA).



**Figure 11** Phases of construction: integration of the elastic pads and rails



**Figure 12** Phases of construction: alignment of the rails

## 4.2 Crane track CV-103

Basic stages of performance of works for the rail track of the CV-103 crane track differs from the previous one in that the concrete strip foundation have been done earlier, and that holes were drilled in the foundation for placement and injection of anchor bolts. Difference with regard to crane track with designations CP-101 and CP-201 is in the type of used anchor bolt and type of clip for the rails (B15/C) [7], which is shown in figures 8 and 10. Difference of this clip and 21/080/BK clip is that the it is not welded to the steel plate, and the fastening is instead performed by screws.

## 5 Conclusion

Crane track structures present a special application of railway engineering and are usually in use for heavy loads in industrial facilities where the traditional rail structure does not satisfy bearing capacity. The crane rail tracks that are part of Bulk cargo terminal at the Port of Ploče, named CP-101, CV-201 and CV-103, were designed and constructed, according to the designed loads and conditions. Special challenge on this project consisted from firstly improving the load-bearing capacity of the entire plateau of the Port of Ploče (this was done based on the getechnical project), and then from designing the foundation work of the crane tracks and rail track construction for large loads where the conditions at the site and adverse effects of the environment where the limiting factor. In order to act preventively on the environmental effects, all components of the crane structure were galvanized and larger protective layer of concrete was envisaged for strip foundations.

## References

- [1] Esveld, C.: Modern Railway Track, Second edition, TU-Delft, 2001.
- [2] Ploce port authority, <http://www.ppa.hr/index.php/2014-04-21-11-37-40/lokacijsko-i-gravitacijsko-podru%C4%8Dje.html>, 18.04.2016.
- [3] Glavni projekt Terminala za rasuti teret u luci Ploče: Kranske staze CV 201, CP 101, CV 103: Projekt temeljenja, projekt kolosijeka: CV 201, CP 101, Projekt kolosijeka: CV 103, 2015, Građevinski fakultet Sveučilišta u Zagrebu, Croatia
- [4] Građevinski projekt otvorenog skladišta rasutih tereta – Projekt ubrzane konsolidacije tla, Hidroelektra-projekt d.o.o., Zagreb, 2008
- [5] Bulk cargo terminal at Port of Ploče – Comments on soil lands seismic parameters, Građevinski fakultet u Zagrebu, Prof.d.sc. Antun Szavits-Nossan, Zagreb, 2009
- [6] Gantrex, <http://www.gantrex.com/wp-content/uploads/2011/01/Rail-Clip-21-080.pdf>, 18.04.2016.
- [7] Gantrex, [http://www.gantrex.de/cms/upload/download/125\\_EN\\_RailLokClipsB15\\_2012\\_11rev0.pdf](http://www.gantrex.de/cms/upload/download/125_EN_RailLokClipsB15_2012_11rev0.pdf), 18.04.2016.





## BALLASTLESS TRACK SYSTEMS ROAD TO RAIL SYNERGIES FOR BETTER TRANSPORT INFRASTRUCTURE

**Bernhard Lechner**

*Technische Universität München, German*

### Abstract

Railway engineers built capable road infrastructure at the beginning of the last century. Today road pavement technologies and respective long-term experiences still foster significant developments in rail infrastructure, especially towards durable tracks meeting low maintenance and high availability requirements for high speed as well as for urban rail. Properly designed and constructed concrete pavements handle high traffic loads like trucks, aircraft and trains. They provide durable and accurate rail alignment and consistent track stiffness, which is essential for high-speed rails. German road pavement design follows the jointed plain concrete pavement (JPCP) concept beside the usage of asphalt pavements. The absence of steel reinforcement would be attractive to rail applications with respect to electric isolation and electromagnetic compatibility requirements. But, the cracking behavior must be controlled safely by proper crack guidance and joint design as well as the risk of permanent deformation of asphalt pavements. Studies of dynamic vehicle track interaction using Multi-Body-Simulation tools show the importance of track stiffness quality beside track geometry leading to the request of unjointed, continuous rail support, which is given by e.g. by asphalt or continuously reinforced concrete pavements (CRCP). Also tracks made by prefabricated slabs offer longitudinal consistency in case the coupling joints transfer horizontal and vertical forces on appropriate level. Ballastless track systems require appropriate support conditions dependent on the type of sub-structure (bridge, tunnel, earthworks), especially along transitions between different sub-structures. Economic track design needs the help of numerical tools (Finite Element Models FEM) to achieve sufficient load distribution by the track structure to adjust the stress level on the supporting structure with respect to plastic deformations (settlements) during service life. The paper gives an overview of the actual research on ballastless track technology as well as on the actual progress of European standardization.

*Keywords: ballastless track, vehicle-track interaction, concrete pavement, asphalt pavement, road-rail synergies*

### 1 Introduction

State-of-the-art of road pavement design and construction in Germany is provided by standards, which are covering long-term experiences and theoretical investigations including research activities. Based on this knowledge the road-engineers are able to choose a suitable design for the planned pavement project using the design catalogue RStO 12 [1]. Content of the RStO 12 are matrices for asphalt, concrete and block pavements created by load classes based on 10t equivalent single axle loads (ESAL) as well as different layer combinations with respect to local availability of materials. The competition between asphalt and concrete pavements is helpful to force steady development on both technologies. Concrete road pavements in Germany are based on Jointed Plain Concrete Pavements (JPCP) technology according to



the actual standards. Other pavement types are also built, but usually along test-sections. The main advantages of conventional ballasted tracks are the low investment costs, the ability to bear very high axle loads at moderate speed and the flexibility with respect to vertical and horizontal alignment modifications, when necessary. Due to the lack of rigid fixations of the sleepers within the ballast bed, regular maintenance is needed to keep the required track geometry, which is done with the help of highly developed effective working machinery. First considerations towards ballastless track technology were fostered by the observation that ballast placed on stiff layers, especially on concrete slabs like bridge decks or tunnel floors, suffered much more rapid degradations than when laid directly on a soil surface (see figure 1). Poor durability of ballasted track on concrete was confirmed in Japan along the 515 km Tokaido Line (Tokyo – Osaka), which was opened in 1964. Nearly 50% of the tracks were laid on civil structures and after 30 years of service 75% of the ballast had been renewed twice. Similar experiences were born on the French TGV route Paris – Lyon (opened 1981) and the first German High Speed Line put into operation in 1990/1991, where high compacted formation protection layers and frost blanket layers were supporting the ballast.



**Figure 1** White spots; Rapid ballast degradation along a bridge deck

A stiff substructure limits the capacity of the rail to distribute the loads and higher vertical contact stresses are working the ballast, even on a quasi-static load level, which lead to increasing maintenance needs. Secondly, increasing train speed generates higher vibration velocities of the ballast stones below sleepers. Measurements showed that the velocity of vertical movement of the ballast stones is doubled when the train speed increases from  $V=160$  km/h to  $V=250$  km/h. More elasticity and damping is needed, which requires improvement of the track superstructure e.g. by high resilient fastening systems.

Exchanging the ballast, which is susceptible to degradation and settlement, by concrete or asphalt layers with high stiffness and bearing capacity needs an elastic interface between rail and supporting structure, which provides a recommended rail deflection of 1.0mm to 1.5mm under traffic loads (usually 20t axle load). Furthermore, the ability of the ballast to compensate unavoidable tolerances should be substituted by a suitable track design and a stringent quality management for ballastless tracks during construction. For all ballastless track systems the interface between cross-section elements prefabricated in plant and elements laid in place is of utmost importance with respect to the long-term behaviour.

## 2 Ballastless Track Systems

### 2.1 Continuous rail supporting structure

In 1972 an innovative railway superstructure was installed at the station of “Rheda”, Germany, made by a Continuously Reinforced Concrete Pavement (CRCP) on a cement treated base (CTB) acting as a rail supporting structure. The main idea to use CRCP instead of the existing JPCP technology in Germany was to match the behaviour and performance of continuously welded rail (CWR) by providing a continuous rail supporting structure. The exactly aligned rails and concrete sleepers had been monolithically fixed to the CRCP by a filling concrete (see figure 2). The prefabricated mono-block sleepers helped to meet the very strict requirements concerning the exact gauge and the correct inclination of the rail. Except rail grinding, no other maintenance work has been done during about 45 years.



Figure 2 Test track at “Rheda” station during construction in 1972 (left) and today (right)

A design standard of Deutsche Bahn AG [2] had been implemented to guarantee an economic design life time of ballastless track structures of 60 years, which is twice compared to the design life of concrete pavements for road infrastructure [1]. The assembled rail can be considered as a beam on a continuous or discrete resilient support (Winkler foundation). The moment of inertia of the rail profile, the spacing of the fastening systems as well as the loads have an influence on the longitudinal distribution of the vertical and horizontal loads applied on the rail. The vertical track stiffness should correspond to a rail deflection under a 20t axle load in a range of 1.0 mm to 1.5 mm. The pavement, as the rail supporting structure, is designed using a higher rail supporting stiffness (e.g. static rail seat stiffness of  $c_{stat} = 40 \text{ kN/mm}$ ) to cover potential changes in stiffness caused by extreme cold temperature conditions and aging effects. The stiffness of the substructure (e.g. earthwork) needs to be defined, in order to design the ballastless track system. It can be defined by using deformation modulus at the formation level, e.g.  $E_{v2} = 45 \text{ N/mm}^2$  (deformation modulus, second loading). Bearing capacity requirement to accept the work in construction phase should be higher, e.g.  $E_{v2} = 60 \text{ N/mm}^2$  which provide additional safety with respect to long-term behaviour. The limiting stress acting on the substructure shall be determined dependent on the substructure performance. Typically, the specified vertical stress activated by rail traffic loading shall not exceed  $0.05 \text{ N/mm}^2$  on top of the formation.

The lateral loads are distributed in accordance with the lateral stiffness of the rail support, which is usually unknown. Typically horizontal forces activated by the running vehicles are distributed by the rail to 60% horizontal wheel loading acting on rail seat below wheel and 20% horizontal wheel loading acting on the rail seats before and after the wheel [3]. Beside lateral forces activated by rail vehicles the track shall be designed to ensure that the longitudinal forces in the track structure particularly activated by thermal effects (heating of the rail) are safely controlled by track buckling resistance. The lateral track resistance of the unloaded track (no vertical loads) should be equivalent to a lateral force of 25kN per meter of track

length. Especially pavements supporting sleepers and rails have to integrate connectors to control the sleeper panel in horizontal direction (lateral and longitudinal).

## 2.2 Ballastless track classification

Several types of ballastless track systems got approval of German rail authority, which can be classified as follows:

- Sleeper directly supported by a concrete or asphalt pavement or sleepers monolithically embedded within a concrete slab;
- Prefabricated, prestressed slabs or frames connected to a treated base by an intermediate layer;
- Fastening systems directly fixed on a Jointed Reinforced Concrete Pavement (JRCP) or embedded rails on a Continuously Reinforced Concrete Pavement (CRCP).

CRCP design according to the actual specification is determined by longitudinal reinforcement with diameter 20mm placed close to the neutral axis of the slab by an amount of 0.8% to 0.9% of the total cross section. The reinforcement provides a sufficient vertical load transfer at the crack or dummy joint (Jointed CRCP) and keeps the crack width below 0.5mm [2]. This limit is also set in [4] for ballastless track systems. Therefore CRCP provide a typical crack spacing between about 0.6m and 2m. The design of slab thickness is based on the tensile bending strength of the concrete according to road and airfield pavement design procedures and experiences.

## 2.3 CRCP reinforcement design and electrical requirements [4]

The structural and electrical properties design of the ballastless track system has to be coordinated with respect to electrical safety, earthing, bonding and the return circuits. This may affect the design of the reinforcement of the CRCP acting as a supporting structure to the rails. The design of reinforcement of the ballastless track system has to consider the constraints of Electro Magnetic Compatibility (EMC) between different equipment, e.g. vehicle/signalling and signalling/signalling. This influence the design of reinforced concrete pavement in general or the design along certain track sections in which closed electrical loops (e.g. created by longitudinal bars connected to transversal bars) have to be avoided. Some signalling devices, e.g. axle counters, may require specific zones, which have to be kept completely free of any metal. The requirements for loop-free zones as well as the requirements for zones with restricted content of metal should be decided between signalling and track designers to optimize the system design. Loop-free zones can be realised by using electrical insulation between crossing rebars, which is costly in terms of labour and causes partly de-bonding between reinforcement and concrete. Alternatively non-ferrous reinforcement can be used. Special requirements may arise from:

- Track circuit: The attenuation of the audio frequency alternating current of the track circuit due to reinforcement loops created by connected longitudinal and transversal bars shall be limited.
- Detection loop or transmission loop: The attenuation of the alternating electrical signal of detection- or transmission loops due to reinforcement loops shall be limited.
- Discrete electrical components: The attenuation of the electromagnetic field of discrete electrical components, e.g. balise (Eurobalise), wheel sensor, axle counting heads, track magnets etc. shall be limited.

### 3 Ballastless track traffic design loads

#### 3.1 Vertical loading

The decisive loads for thickness design are determined by the load distribution achieved by rail, fastening systems or embedded blocks. For mainline tracks with mixed traffic (passenger and freight trains) the load model 71 with four 25t axle loads (spacing 1.6m only) should be used. If the line is dedicated to specific vehicles such as high speed trains with a much lower axle load, then the decisive load model according to line category or the real vehicle should be used. Additional quasi-static vertical loads are activated by centrifugal acceleration along curves. Dependent on the level of the centre of gravity above the rails the vertical wheel load is increased along the outer rail but decreased along the inner rail, which should be covered by a maximum change of 20 %. Special vehicles like tilting trains may activate higher load shift. Additional dynamic loadings are in correlation with speed, vehicle conditions and track quality. On the safe side an overall, dynamic factor of 1.5 is applied to all static and quasi-static loads. [4] offers possibilities to integrate proven, good track quality into the design by reducing the dynamic loading from constant factors down to adopted quality factors. The track quality is strongly dependent on construction work procedures (ballastless track design includes the design of construction procedures) or degree to which the track is properly maintained (ballasted tracks). Parameters specifying the track quality include geometry (undamped) and track stiffness (damped). Detailed description of track quality with respect to contribution to dynamic loading by train speed, track geometry and track stiffness was done by [5] with the help of co-simulation tools based on Finite Element Method (FEM) and Multi Body Simulation (MBS). The Power Spectral Density (PSD) distribution is used by [2] to check the track quality of a ballastless track system with respect to track geometry. Figure 3 shows the PSD distribution of a measured ballastless track system, which is well below the limit set by [2]. As demonstrated by table 1 modern ballasted and ballastless track high speed lines are expected to induce a lower level of dynamic effects between vehicle and track due to improved track geometry condition. The measured high speed ballasted track in table 1 represents the dynamic loading factor based on track conditions after 1 year of service, while the dynamic loading factor of the reference track demonstrates the effect of PSD equivalent to the track geometry limits of [2]. Dynamic loading factors determined on existing, measured ballastless track systems are significantly lower, even on higher speed level. This can be turned into a more economic track design.

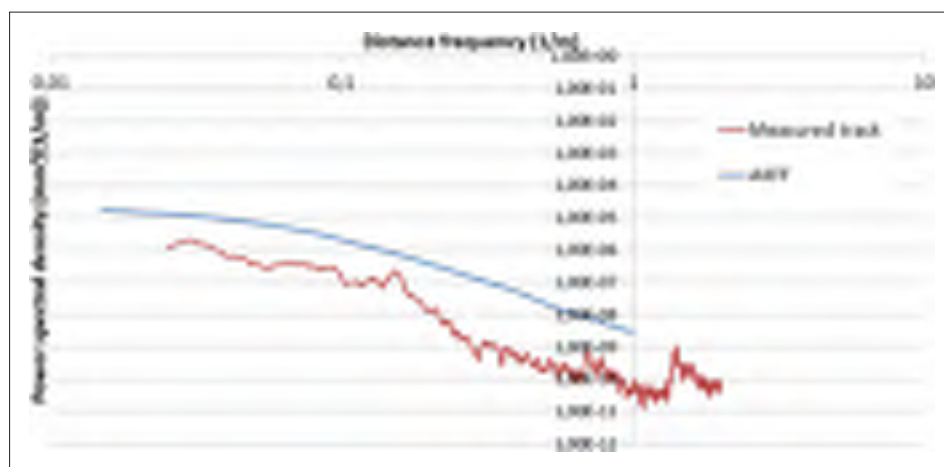


Figure 3 Power Spectral Density distribution of a real ballastless track and PSD-limits [2],[5].

**Table 1** Dynamic track loading factors determined by [5]

Track type	Simulation input	Dynamic loading factor [%]
Measured ballastless track (V=300km/h)	Geometry only	11.4
	Stiffness only	8.6
	Geometry and Stiffness	11.1
Measured ballasted track (V=250km/h)	Geometry only	24.6
	Stiffness only	6.3
	Geometry and Stiffness	25.2
PSD reference track [2]	Geometry and Stiffness	29.5

If the track geometry condition fulfils the requirement of [2], defined by Power Spectrum Density (PSD) distribution of vertical track geometry and if modern vehicles are used, which are travelling with a speed below 300 km/h, than dynamic loading factor  $k_d$  according to [5] can be applied:

$$k_d = 1 + (V^2 + 128000)/625000 \quad (1)$$

where:

V – train speed [km/h].

### 3.2 Lateral track loading

The ballastless track design has to demonstrate that the lateral loads according to eqn. (2) will be safely handled and distributed by the rail supporting structure. During approval testing new rail vehicles have to demonstrate that the lateral force acting on the track is not exceeding Y:

$$Y = 10 + 2xQ/3 \quad (2)$$

where:

Y – Sum of lateral guidance forces acting on the rail [kN],

Q – Vertical static wheel load [kN].

## References

- [1] Forschungsgesellschaft für Straßen und Verkehrswesen FGSV. Richtlinien für die Standardisierung des Oberbaues von Verkehrsflächen (RStO-12). Ausgabe 2012. Köln, 2012.
- [2] DB-Systemtechnik. Anforderungskatalog zum Bau der Festen Fahrbahn. DB-Netz, Frankfurt, Germany, 2002.
- [3] Liu, J.: Einfluss der Schienenbefestigungskomponenten auf das laterale Verformungs- und Lastverteilungsverhalten der Schiene. Lehrstuhl und Prüfamf für Verkehrswegebau, Schriftenreihe Heft 87, München 2012., ISSN 0341-5538
- [4] CEN/TC 256. prEN 16432-2: Ballastless Track Systems – Part 2: System design, Subsystems and components, 2016., not published
- [5] Liu, D., Lechner, B., Freudenstein, S.: Evaluation of High Speed Track Quality using dynamic simulation of Vehicle-Track-Interaction. Journal of Transportation Technologies, 6, 2016.



## RECONSTRUCTION OF THE RAILWAY STATIONS SLAVONSKI BROD AND VINKOVCI

**Snježana Špehar**

*HŽ Infrastruktura, Zagreb, Croatia*

### Abstract

Railway stations Slavonski Brod and Vinkovci are situated on the Corridor RH1 railway line M104 Novska – Tovarnik – state border. The modernization of the Corridor RH1 also included the reconstruction of the railway stations Slavonski Brod and Vinkovci. Complex civil-engineering works included the removal of the shelter of the 1<sup>st</sup> platform at Slavonski Brod railway station, reconstruction of the platforms, construction of the glass and steel shelters, reconstruction of the rainwater drainage, reconstruction of lighting, installation of the sounding passenger information system, installation of platforms for mobility-impaired persons, and a range of other operations which have contributed to the modernization and functionality of the railway stations Slavonski Brod and Vinkovci, but also to their up-to date and modern appearance.

*Keywords: reconstruction of the railway stations Slavonski Brod and Vinkovci*

### 1 Introduction

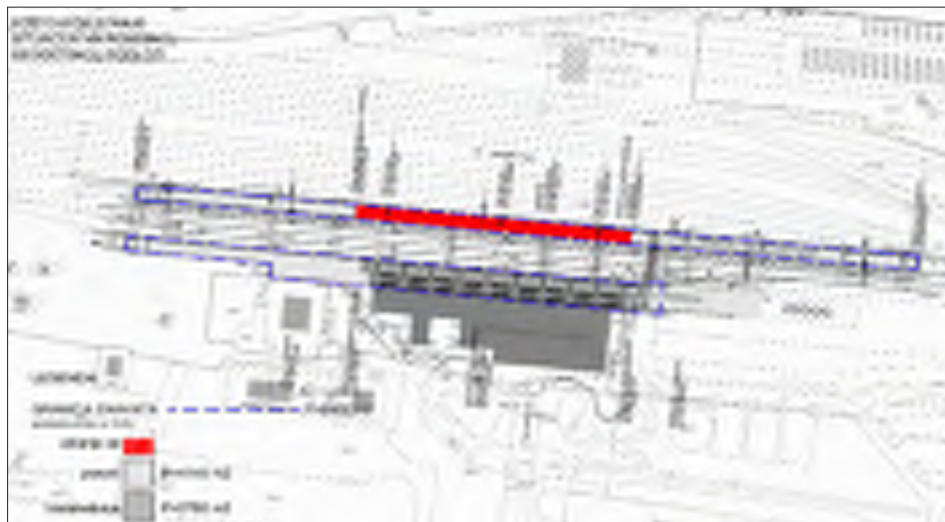
Railway station Slavonski Brod and Vinkovci are situated on the RH1 Corridor of the double track railway line M104 Novska – Tovarnik – state border. Double track railway line M104 Novska – Tovarnik – state border is one of the four railway lines on the RH1 Corridor, or the former Pan European Corridor X; the Corridor was named RH1 in accordance with the Decision on Classification of the Railway Lines (Official Gazette 3/14) of the Government of the Republic of Croatia. Because of the deterioration of the shelters which began to lose their essential qualities through their use, but also because of the need to reconstruct other civil-engineering structures in the station in order to enhance the safety and quality of service for the railway transport users, were reasons, in accordance with the guidelines of the Study of Modernization of the Pan European corridor X (ŽPD LLC., TB4070, Zagreb 2009) the works on reconstruction and modernization of the railway stations Slavonski Brod and Vinkovci were started, based on the project documentation and main design approvals.

### 2 Current condition

Railway station Slavonski Brod is situated at km 220+691,14 of the double track railway line M104 Novska – Tovarnik – state border and is used for reception and dispatch of passengers and freight. The station consists of two platforms with asphalt flooring, one of which is situated by the railway station building and is 907 m long, on the average 13,30 m wide and 0,35 m high above the top of the rail (hereinafter ATR). The second platform is situated between the 5<sup>th</sup> and 6<sup>th</sup> track, and is 407,39 m long, 6,30 m wide and 0,35 m high from the ATR. From the station building to the second platform the pedestrian underpass extends, with two single-flight staircases on both sides, above which the five tracks, directly laid on the concrete



slab of the pedestrian underpass, are passing. On the 1<sup>st</sup> platform there is a 144,60 m long RC shelter, the structure of which is supported against the concrete posts, by the station building on one side, and on the other side it stretches towards the 1<sup>st</sup> track with its cantilever.



**Figure 1** Railway station Slavonski Brod – the current condition floor- plan on the special geodetic lining

On the same railway line, at km 155+862,25 railway station Vinkovci is situated. It is operating as the combined transport railway station (passenger and freight transport). Railway station Vinkovci consists of the passenger part with five tracks. The station consists of three platforms connected by the pedestrian underpass also with the single-flight staircase on both sides of the pedestrian underpass, with exit to the three platforms where 1<sup>st</sup>, 2<sup>nd</sup>, 3<sup>rd</sup> and 4<sup>th</sup> track pass. The platforms are laid on the overburden above RC slab of the pedestrian underpass. The first part of the 1<sup>st</sup> platform is situated by the station building between the tracks 1 and 1c. It is 420 m long, 13,8 m wide, while the second part of the 1<sup>st</sup> platform is situated between the track 1A and the auxiliary business building. It is 75,0 m long and 15,0 wide. It has the entry ramp for access to the luggage pedestrian underpass which is placed in the centre. The third part of the 1<sup>st</sup> platform is situated in the western part between the tracks 1 and 1B. It is 13,8 m wide, and in the centre it has the exit ramp from the luggage pedestrian underpass. The 2<sup>nd</sup> and the 3<sup>rd</sup> platform are situated between the 2<sup>nd</sup>, 3<sup>rd</sup>, 4<sup>th</sup> and 5<sup>th</sup> track. They are 420 m long, 8,8 n wide and 0.35 m high ATR, and have asphalt flooring.

The RC shelter on 1<sup>st</sup> platform is a symmetric 13,7 m wide and 318,40 m long framework structure with cantilevers. It is constructed in two levels because of connection to the building, where the higher part in the width of up to 10,40 m is supported against the framework structure with the cantilever, and is made of 13 fields. In the lower part there is a 3,3 m wide RC slab with glass apertures, supported against the station building. The eastern part of the 69 m long and 9 m wide shelter of the 1<sup>st</sup> platform is also made of the framework structure of 9 fields, while the 65,30 m long and 16,0 m wide part above the platform 1A and auxiliary business building consists of 8 fields. The shelter of the station building and the auxiliary business building is connected between the two eastern parts into a single field of 64 m<sup>2</sup>.

In the 2<sup>nd</sup> and 3<sup>rd</sup> platform there used to be the RC shelters which have been removed, except for the RC posts of 0,60x0,40, 0,60x0,25 and 0,40x0,40 m. They will be used for installation of the steel part of the new shelters. 1<sup>st</sup> and 2<sup>nd</sup> platform in station Slavonski Brod and the 1<sup>st</sup> platform by the station building in station Vinkovci are for the most part equipped with

the urban equipment: station name, info-panels, public-address system, LED information panel, banks, waste bins, clocks and pictograms; however the island platforms in station Vinkovci, i.e. 2<sup>nd</sup> and 3<sup>rd</sup> platform, of the urban equipment have only the banks, waste bins and pictograms.

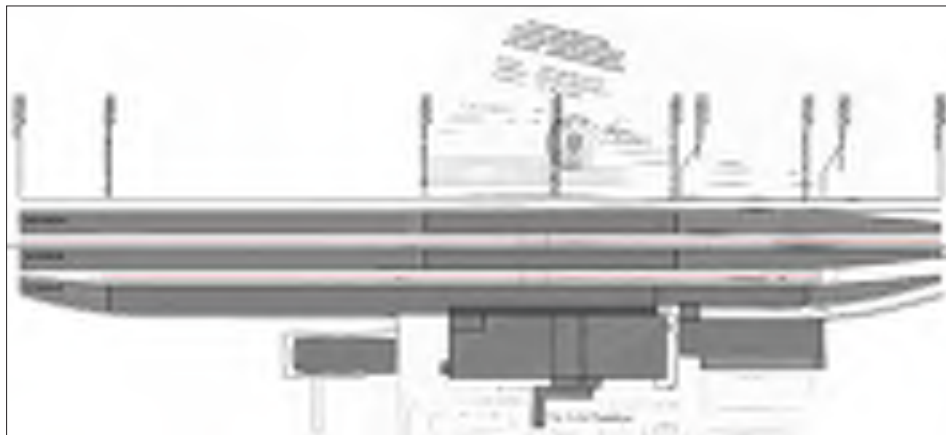


Figure 2 Floor-plan of the platforms and shelters in railway station Vinkovci



Figure 3 Railway stations Slavonski Brod and Vinkovci in the initial phases of reconstruction

### 3 Project documentation

On 04.04.2011 the approval on the main design for the project documentation Reconstruction of the railway station Slavonski Brod / Removal and construction of the replacement shelters, Reconstruction of the 1<sup>st</sup> and 2<sup>nd</sup> platform, TB 4049, common reference M105-GP-4049, ŽPD PLC December 2010, Class 361-04/11-01/12, Reg.no. 2178/01-10-11-8, was issued by the Administrative department for construction, spatial planning and environmental protection of the City of Slavonski Brod.

On 14.10.2009. the approval on the main design for the project documentation Reconstruction of the railway station Vinkovci, of the platform shelters and island platforms, class 361-03/08-01/171, Reg.no. 2188/01-10-09-7 protection of the Town of Vinkovci, TB 3968, common reference M105-GP-3968, ŽPD, PLC., November, 2008 was issued by the Administrative department for construction, spatial planning and environment of the Town of Vinkovci, for the railway station Vinkovci. For both railway stations the detailed designs have been prepared, based on which the works of reconstruction were carried out.



## 4 Reconstruction operations

In addition to the scope of operation, the reconstruction operations also differed regarding the methods and manner of construction of particular structures. In the railway station Slavonski Brod the reconstruction of the 2<sup>nd</sup> platform included the reconstruction of the rain-fall drainage, installation of lighting and sounding system as well as reconstruction of the signalling and interlocking lines of the power electric infrastructure subsystem. In the reconstruction of the platform the existing length of the platform was retained, and the width reduced to 6,10 m, in order to meet the condition that the platform is at a distance of 1,72 m from the track axis (the Rulebook on technical conditions for the railway transport safety to be met by the railway lines OG 128/08). The height of the platform was elevated from 0,35 m to 0,55 m from the ATR by installation of the standard platform elements L<sub>0</sub> 55 on the concrete edge. Since the basic construction of the shelters has been conceived as the system of the fieldstone foundations (under each post), joined by the foundation beams in both directions on the sites where the foundations were, the adaptation of the existing foundations to the designed height was carried out, by concreting of the new 2,50 m x 1,6 m, and 2 m high posts, with the depth of the footing of -2,2 m, using reinforced steel B500B.

The platform inclination in cross direction is 2% from the track, which was accomplished by flooring by the 8 cm thick concrete elements, planted on the 3-5 cm thick sand layer, placed on the 30 cm thick sub base layer. At the platform edge, at the distance of 2,4 m from the track axis, the horizontal yellow 10 cm thick signalization was placed, and at 2,5 m from the track axis the 20 cm wide tactile surfaces with grooves carved vertically to the direction of the entry into the train, in order to enhance the safety of the passengers and to help movement direction of the mobility-impaired persons. Also, in the platform before the first step, the 40 cm wide tactile warning strip was placed in the full width of the staircase flight, with the grooves carved vertically to the movement direction. All platform ends have been accomplished at 7,5% inclination, thus having been adapted to the current official ramps which were situated at the platform ends. From western direction the access is provided for the ambulance and emergency vehicles. For the mobility-impaired persons the access to the platform is provided by the two pairs of moving platforms which are installed at one staircase flight. At the staircase of the platform the new 1,10 m railing is installed.

The steel structure of the shelter consists of the Y-shaped fixed posts with two-sided cantilevers between which the purlins are placed, which are additionally stabilized by the system of the roofing bonds and lateral constraints. The posts are welded into profile I of 3,6 m high variable cross-section, at the mutual distance of 7,2 m with two-sided cantilevers of 3 m in span and 4 m in length, except in the part at the exit from the pedestrian underpass, where in two fields, their distance is 14,4 m. The shelter cover is constructed of 1x0,75 mm trapezoidal sheet metal type Hoesh T40, and the view of grey HPL plates. In the centre of the shelter structure the drainage of galvanized sheet metal is constructed and is descending by 3%, which is evacuated through the steel posts into the drainage by the inox pipes in the platform. The view of the shelters houses the lighting installations and lighting and the sounding system. The display board and the clocks are mounted on the girders, and on the frontline of the structures on both sides the sign plates with the station names are mounted. Of urban equipment, the cabinet with the train timetable, banks for passengers, waste bins, and info-panels have been placed.

During execution of works, all transport operations took place on 1<sup>st</sup> platform, and after the works were carried out on 2<sup>nd</sup> platform, the 2<sup>nd</sup> platform was temporarily put into operation, and 1<sup>st</sup> platform was completely closed to be able carry out the works of dismantling of the shelter and reconstruction. The passengers arrived to the 2<sup>nd</sup> platform through the station building towards the basement where the passage was temporarily opened in the wall of the pedestrian underpass. After the 1<sup>st</sup> platform was closed for transport, the removal of the RC shelter structure began. The overhead parts, posts, beams and plates covering the surface of 1885

m<sup>2</sup> were removed using the “cutting” and “nibbling” method by the station building, which means that the structure was being removed part by part; the material was being sorted by the categories (armature, concrete, glass, sheet metal, etc) and was transported to be disposed of in an ecological way. After the removal works were completed, the reconstruction of the 1<sup>st</sup> platform began. The reconstruction of the 1<sup>st</sup> platform consisted of elevation of the platform from 0,35 to 0,55 m, so that the platform edge is at the distance of 1,72 m from the track axis, with the cross descent from the track and the station building of 1,5 – 2 % towards the centre, where in the full usable length the concrete drainage channel was constructed, from which the water is drained into the drainage in the platform. The final surface of the platform was constructed with the 5 cm thick asphalt layer due to the descents, and at 2,4 m the horizontal yellow signalization in the width of 10 cm along the entire platform length, while at the edge of the steps descending into the pedestrian underpass, the new 1,10 m high railing was installed. The existing foundations in the platform with the RC structure were reconstructed by elevating them to the designed height, but it was also necessary to concrete the new foundations since the grid of the posts is linearly 14,4 m by the station building, and 7,2 m by the outer platform edge, while in the cross direction the distance amounts to 10 m. Of other works, the works of reconstruction of the rainfall drainage and installation of lighting and sounding system were carried out. The 144,60 m long and 12,98 m wide shelter of the 1<sup>st</sup> platform consists of the steel structure of 10 m in span and 3,3 m high posts and the arch beam, while the frame on one side has the protruding 3 m long cantilever. The posts are placed every 14,4 m. The cantilever part of the shelter towards the track is flat and covered by the 1x0,75 mm trapezoid sheet metal, type Hoesch T40.

The shelter view is constructed of HPL grey plates which are attached from the bottom side of the grey colored purlins and into which the lighting and loudspeakers are installed. The part of the shelter from the posts towards the building in parts the arch shape is covered by the trapezoid sheet metal and the view by the HPL plates, while the flat part, descending towards the building by 4%, is covered by the arches of the glass surface of triangular shape. The arch surfaces are placed above the glass ones, and the purlins are recessed to the left and right on top of the arch girders, sheltering the free vertical space to prevent oozing of water. The peripheral parts of the surface have the trough grooves in full length, which direct the accumulated water towards the drainage. All sides of the triangle tip of the narrowed glass surface towards the building are encased into sheet metal creating a funnel which channels the water into a vertical by the building. The glass is 2x10,1 mm double-glazed laminated and toughened safety top glass with the 0,76 mm thick interlayer film in red, yellow, blue, green and translucent colour. The flank sides are blocked by the 2x10,1 mm thick glass with the interlayer film on both sides, while from the side of the tracks and the station building, there is the metal sheet trim.

On the platform the names of the stations were placed at the frontline of the structure, as well as two small displays and the central display, clocks, waste bins, banks and flower pots. In addition to the reconstruction works, the works of replacement of the materials in the pedestrian underpass, reinforcement of the track, asphalt replacement by the station building and in the part of the platform by the power electric plant were carried out. The replacement of the materials in the pedestrian underpass involved the removal of the tiles from the wall of the staircase, pedestrian underpass and floor, replacement of all step treads, drainage solution, plastering, smoothing and painting of the walls of the staircase, pedestrian underpass and the ceiling, laying of tiles and of tactile strips on the floor of the pedestrian underpass, for the persons with reduced mobility.

The works of reinforcement of the 1<sup>st</sup> track included the dismantling of the rails type 49E1 on wooden sleepers, machine excavation of the muddy ballast material, construction of the track with the re-used 49E1 rails on the re-used wooden sleepers, AT welding of the track, lifting of the CWR, installation of the Mathe equipment and manual planning and design of the shunting paths. On the 5<sup>th</sup> and 6<sup>th</sup> track the elevation of the track level line was carried out.



Figure 4 2<sup>nd</sup> platform of the railway station Slavovski Brod after the reconstruction



Figure 5 Ramp for the disabled persons and the pedestrian underpass of the railway station Slavovski Brod



Figure 6 61<sup>st</sup> platform of the railway station Slavovski Brod after reconstruction

Reconstruction of the 2<sup>nd</sup> platform of 3590 m<sup>2</sup> and the 3<sup>rd</sup> platform of 3577 m<sup>2</sup> of the railway station Vinkovci required the elevation of the platform from the existing 0,35 m to 0,55 m ATR. In this way the platform length of 420 m and width of 8,8 m was retained and the distance of 1,72 m from the ATR was accomplished by concreting of the 20 cm high concrete edge which was by 12 cm more retracted compared to the current platform edge. The surface of the platform in the cross direction was constructed in inclination of 2% from the track axis and was floored with the 8 cm thick concrete paving flags which were placed on the 3-5 cm thick sand layer. By the platform edge, at the distance of 2,4 m from the track axis the yellow signalization was outlined in the form of the 10 cm wide line and the tactile surface in form of the 20 cm wide warning strip at the distance of 2,5 m from the track axis was installed. In reconstruction, the ends of the 2<sup>nd</sup> and 3<sup>rd</sup> platform were adapted to the new height with the inclination of 7,5%, and from direction west the access ramps enable the access of the ambulance and emergency vehicles. In the platforms the reconstruction of the rainfall drainage, installation of the lighting and sounding systems as well as reconstruction of the signalling and interlocking lines of the power electric infrastructure subsystem were carried out.

On RC posts in the 1<sup>st</sup>, 2<sup>nd</sup> and 3<sup>rd</sup> platform the non-destructive and destructive tests were performed. The visual inspection included the detailed inspection of the outer surfaces of all posts, taking record of the damages; the ultra-sound method was used to determine the depth of the cracks in the non-destructive manner; the sclerometer index was then defined; the depth of carbonization and the concentration of the chloride ions in the concrete powder was examined by the RCT method, as well as the pressure hardness of the concrete which was extracted from the structure by drilling. Based on the obtained results, the guidelines were provided for the reconstruction of the posts on the 2<sup>nd</sup> and 3<sup>rd</sup> platform. It was established that the posts at the bottom on the 1<sup>st</sup> platform were highly damaged due to the grenade blasts, and that their retaining capacity is questionable.

After the tests and reconstruction of the posts were completed, on the 2<sup>nd</sup> and 3<sup>rd</sup> platform the shelters of 1021 m<sup>2</sup> of floor-plan surface were mounted. The shelter is made of the plane two-sided cantilevers of 4,4 m in span, made of HEA 300 steel profiles and placed on the posts which are fixed on the foundations. The joint of the cantilever and the post was made by the steel cap. The structure of the roof is made by the purlins made of IPE 270 steel profiles which are coupled to the main cantilever girders in the articulated joint. Between the purlins there is a couple of the pulling elements. The purlins are joined in the half of the span by the cross beam of round diameter, which is at the same time the vertical couple. The floorplan dimensions of the shelter are 116,0x8,8 m, the average height from the platform is 4,65 m. The structure consists of 16 symmetrical (two-sided) cantilever steel girders at the axis distance of 7,5 m. The shelter ends are made as cantilevers with the length of 1,7 m. The shelter cover is made of the 160 t=0,63 mm trapezoid steel plasticized sheet metal Hoesch HP41, and the view of perforated sheet metal type Hoesch 35/207 which is attached from the bottom side of the purlins and is of grey colour. The groove of galvanized sheet metal is constructed in the descent of 3% and is mounted into the shelter eaves. The drainage is constructed from the outer side of the posts through the drainage pipes. The lighting and sounding systems are installed in the space between the cover and the view of the shelter. On the flank sides of the shelter, i.e. the frontline of the structure, the names of the stations are placed, on the structures the displays and clocks and on the platforms the waste bins, banks and info-panels.

The access to the platforms is provided by the two-sided single-flight staircase connecting all three platforms and by moving platforms for the mobility-impaired persons. On the posts by the platforms the bell is installed, which after being pressed is activated in the traffic control office, signalling someone's presence and the need to help the persons of reduced mobility. On 1<sup>st</sup> platform the existing posts are torn down and the new ones are made of concrete, on which the identical structure as in 2<sup>nd</sup> and 3<sup>rd</sup> platform was placed. Since it is installed by the existing RC shelter, it is with its front supported against the shelter at one side, and at the other side it is the 1,7 m long cantilevers.

In addition to the above works, the replacement of the materials in the pedestrian underpass was carried out as well as reinforcement of the tracks 1A, 1C and of the 2<sup>nd</sup> track, reconstruction of the shelter roof of the RC structure of the 1<sup>st</sup> platform and asphaltting of the 1<sup>st</sup> platform. In the pedestrian underpass the replacement of the materials involved the removal of the cracked wall which was used as the protection wall behind which the drainage of the lateral sides of the walls of the pedestrian underpass was installed; removal of the tiles from the floor, walls and the stairs, drainage resolution, replacement of all stair treads, installation of the aqua panels, plastering, smoothing and painting of the walls of the staircase, pedestrian underpass and the ceiling, laying of the tiles and tactile strips for the persons of reduced mobility. The works of reinforcement of the 1A, 1C and 2<sup>nd</sup> track included the dismantling of the rails type 49E1 on wooden sleepers, machine excavation of the muddy ballast material, construction of the track with the 49E1 rails on new wooden sleepers, AT welding of the track, lifting of the CWR, installation of the Mathe equipment, 1<sup>st</sup>, 2<sup>nd</sup> and 3<sup>rd</sup> machine track regulation and the final track regulation.

On the 1<sup>st</sup> platform the reconstruction of the RC shelter was carried out. The reconstruction of the roof of the RC shelter structure of the 1<sup>st</sup> platform involved removal of the damaged and deteriorated hydro-insulation from the roof, and the broken glaze was smashed and removed. The surface which was cleaned was coated with the SN coating (SN vez). On which the glaze with descents was placed, hydro insulation membrane type V-4 in two layers and alumite paint as protection from UV radiation. The verticals and the gully grids have been replaced; the view of the structure has been smoothed and painted with grey colour, and on the ceiling the new lighting fixtures have been mounted. On the 1<sup>st</sup> platform the broken and deteriorated asphalt layer has been replaced by the 5 cm thick new one.

During execution of works, the passenger and freight transport operations in the railway station Vinkovci took place nonstop. During execution of works on 3<sup>rd</sup> platform, the transport operations took place along the 1<sup>st</sup> and 2<sup>nd</sup> platform. When the works on 3<sup>rd</sup> platform were completed, while the works were carried out on 2<sup>nd</sup> platform, the 3<sup>rd</sup> platform was temporarily put into operation and, together with 1<sup>st</sup> platform, was used for the passenger reception and dispatch. After the works were completed, all three platforms were operating, regardless of the fact that the technical inspection and issuance of the usage permit took place much later.



Figure 7 Railway station Vinkovci after reconstruction





**Figure 8** Ramp for the disabled persons in the pedestrian underpass of the railway station Vinkovci and elevation platform



**Figure 9** Shelter on the 1<sup>st</sup> platform and the view after reconstruction

## 5 Conclusion

Reconstruction of the railway stations Slavonski Brod and Vinkovci contributed to modernisation of the RH1 Corridor, aimed at harmonization with the Technical specifications for interoperability of the Trans-European conventional railway system for the civil-engineering infrastructure subsystem. Reconstruction of the railway stations Slavonski Brod and Vinkovci was carried out based on the project documentation and the approvals of the main design. It entailed complex civil-engineering works which included reconstruction of platforms, construction of shelters, reconstruction of lighting and sounding systems, of the passenger information system, construction of platforms for the transport of mobility-impaired persons, installation of the platform equipment, and a range of other civil-engineering works which were carried out in order to meet the technical conditions and the key properties of the structure, which contributed to modernization and functionality, a safer and better service, but also to the up-to-date and modern appearance of the railway stations Slavonski Brod and Vinkovci, as one of the parts of the Pan-European Corridor.

## References

- [1] Željezničko projektno društvo d.d.: Main design: Reconstruction of the railway station Slavonski Brod, removal and construction of the platform shelters; reconstruction of 1<sup>st</sup> and 2<sup>nd</sup> platform, TB 4049, project reference M105-GP-4049, December 2010.
- [2] Željezničko projektno društvo d.d.: Detailed design: Reconstruction of the railway station Slavonski Brod, removal and construction of the platform shelters; reconstruction of 1<sup>st</sup> and 2<sup>nd</sup> platform, TB 4049, TB 4049, project reference M105-IZP-4049, July 2011.
- [3] Željezničko projektno društvo d.d.: Main design: Railway station Vinkovci; platform shelters and island platforms, TB 3968, project reference M105-GP-3968, November 2008.

- [4] Željezničko projektno društvo d.d.: Detailed design: Reconstruction of the railway station Vinkovci, platform shelters and island platforms, TB 3968, project reference M105-IP-3968, April 2010.
- [5] Administrative Department for construction, Spatial Planning and Environmental protection of the City of Slavonski Brod; Main design approval; Decision (correction in the Approval), class 361-04/11-01/12, Reg.no. 2178/01-10-11-8, Slavonski Brod, 04.04.2011.
- [6] Administrative Department for construction, Spatial Planning and Environmental protection of the City of Vinkovci: Main design approval, Class 361-03/08-01/171, Reg.no. 2188/01-10-09-7, Vinkovci, 14.10.2009.
- [7] Government of the Republic of Croatia: Decision on Classification of the Railway Lines, OG 3/14, 2014.
- [8] Ministry of Maritime Affairs, Transport and Infrastructure: the Rulebook on technical conditions for the railway transport safety to be met by the railway lines, OG 128/08, 2008.
- [9] The 6<sup>th</sup> international conference of HDŽI Slavonski Brod, 29.05.2014., Investment spending into modernization of railway corridors RH1, 2014.

## 12 NOISE AND VIBRATION







## VIBRATION-NOISE-CANCELLING ASPHALT PAVEMENT: INNOVATION FOR SILENT CITIES

Loretta Venturini, Sergio Carrara  
*ITERCHIMICA, Italy*

### Abstract

There are different factors that can affect the life quality and involve different areas of human activity, especially in urban areas. Noise and vibration are two elements to which people are more susceptible, because sometimes they can affect the physical and mental well-being. The process of industrialization and motorization can be considered as the main reason for the existence of these two factors. For example, the vibrations generated by road traffic, as well as being a source of trouble for residents, can cause damage to buildings and equipment in the areas close to roads. Sometimes it interferes with activities such as those carried out in operating rooms or in precision laboratories. Several legislative solutions have been undertaken in recent years, to decrease road noise, even if the efforts to reduce vibrations are not appropriate to the level of damage done. Experts and researchers around the world have been studying solutions aimed at the mitigation of these disturbing elements. Interesting studies have been carried out on road paving construction materials which are capable of reducing vibrations caused by road traffic. Iterchimica's researchers have developed a special technology based on the use of rubber powder derived from recycled tyres at the end of their service life, which can reduce vibration and the resulting rolling noise. In reference to the latter the results of a study conducted in collaboration with iPOOL srl, a spin-off of the Italian National Research Council (CNR) are reported.

*Keywords: noise mitigation; crumb rubber; anti-vibration*

### 1 Introduction

The traffic represents an important source regarding the noise pollution affects all the urban areas inside a city. Each vehicle running over the asphalt pavement becomes a noise source in movement. It's possible to follow different strategies in order to reduce the traffic noise that can be divided in 2 groups:

- Active Solutions focused on the noise reduction at the source level;
- Passive Solutions focused on the noise energy limitation before who is the receiver.

The vehicle manufacturers can work on all noise parameters connected with the mechanic components while the pavement designers have to focus on the power noise reduction coming from the tyre-pavement interaction. Rolling tyre noise and vibrations are among the most important sources disturbing the life quality in urban areas; it is on these parameters that the asphalt and pavement designers have to work, introducing new technologies. The use of a particular compound prepared by using selected crumb rubber and special polymers can reduce the tyre rolling noise and the vibrations generated by the vehicular traffic.

## 2 Vibrations caused by traffic

The vehicular action generates vibrations and noise; the sources are: engine, air resistance, tyre rolling on the surface, as well as use of the brakes. In addition, other noises are produced depending on pavement surface that is never perfectly smooth and flat, due to the laying procedure, the technology used and the presence of surface damages.

The result of these actions causes an oscillatory movement in the vehicle, disturbing the users on board, and the energy waves that propagate in the pavement structure reach the structure and the person who lives inside. It is also very important to know that the transfer of vibrations from the source to the receiving point takes place in different phases, during which the vibrational waves are modified before being retransmitted (Fig. 1).

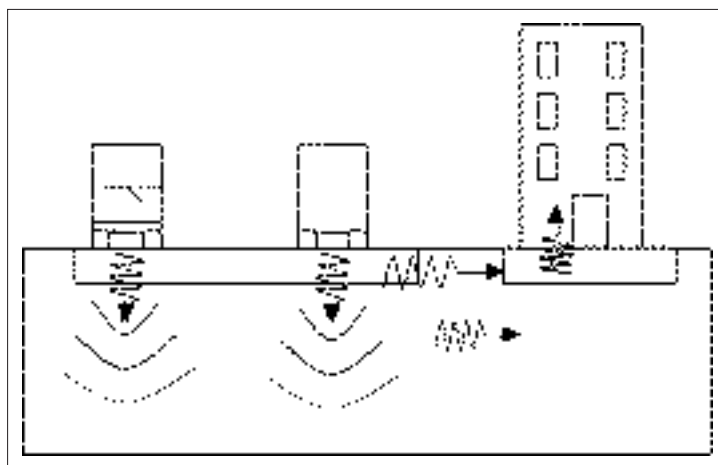


Figure 1 Scheme of transmission of traffic vibrations

Anyway, the interaction between road surface and vehicle can be considered an emitting source in the range of the low-mid frequency (<1000 Hz approximately). Over the past 20 years, some researches have shown that the structure of the pavement has a strong influence on the rolling tyre noise and vibrations. The rolling tyre noise depends on two main factors:

- 1) The maximum size of the aggregates and the aggregate gradation used in the asphalt mix: Using negative surface texture it's possible to reduce the rolling tyre noise thanks to the reduction of the air pumping effect;
- 2) Reducing the pavement stiffness it's also possible to mitigate the vibrational noise component;

Regarding vibrations the most influential physical-mechanical characteristics are stiffness and damping capacity. Therefore, the anti-vibration pavement must be studied considering and changing those two elements.

## 3 Anti-Vibration pavement using robber powder

### 3.1 Optimization of the pavement texture

Researchers have shown that, in order to reduce the noise emission from rolling and vibration, the texture should be optimized according to the following general characteristics:

- the micro-texture ( $\lambda < 0.5$  mm) must be increased, in order to reduce the noise due to air pumping (the air will be compressed and expanded inside this micro texture structure);

- the macro-texture ( $0.5 < \lambda < 50$  mm) must be composed by high amplitudes in the range of wavelengths 1-8 mm, instead the amplitudes should be low in the range 10-50 mm (reduction of the noise component due to the vibratory phenomenon);
- the maximum diameter of the aggregates in the mixture should not be more than 8 mm in order to obtain layer with low-noise and vibration (in any case, the maximum diameter should not be more than 10 mm);
- the aggregates shall be crushed in order to increase the texture levels at low wavelengths;
- the texture must be negative; the road profile has a negative texture when it is characterized by valleys (Fig. 2-3).



Figure 2 Positive texture of the road surface



Figure 3 Negative texture of the road surface

- the pavement must have a homogeneous macro-texture;
- the aggregates used must have cubic shape so the orientation does not affect the values of mega-texture ( $50$  mm  $< \lambda < 500$  mm) that can influence the vibration.

### 3.2 Optimization of the sound absorption and vibration of material for road pavement

In order to design a new anti-vibration material it is important to consider that:

- 1) The frequency of maximum absorption must lie at the frequencies of maximum emission (this frequency is about 1000 Hz for roads with high driving speed, while is around 600 Hz for those at low speeds);
- 2) The vibration wavelengths that affect the buildings and their inhabitants are included between 10 and 300 Hz;
- 3) The absorption spectrum must be large enough to dissipate the noise emission in a frequency range that is as wide as possible;
- 4) Materials such as bituminous mastic and rubber confer elasticity in order to absorb mechanical energy, damping the oscillations induced by the passage of vehicles and the resulting vibrations.

Especially concerning the last point, the pavement designer can introduce new innovative technologies in order to add in to project a possible solution to reduce the vibration made by the traffic.

## 4 No-noise pavement using robber powder

The studied no-noise bituminous mixture for wearing course is made by a mixture of crushed aggregates, sand, filler, bitumen and polymeric compound with rubber powder. It allows the reduction of the noise emission thanks to the optimized texture and the reduction of vibration transmission due to the stiffness studied.

The bitumen used 50/70 penetration (classified according to UNI EN 12591) in a dosage ranging between 6.5 – 8 % on the weight of the mixture.

The bituminous mixture studied is a gap graded type with a discontinuous gradation studied to reduce the rolling tyre noise, linked by a mastic characterized by a high viscosity and composed of bitumen, filler and polymer compounds to reduce the final mixture stiffness and the vibrations connected. This polymeric compound is made with a mixture of rubber powder especially studied and different polymers and it must be dosed at 2-4% on the weight of the aggregates, Figure 4.

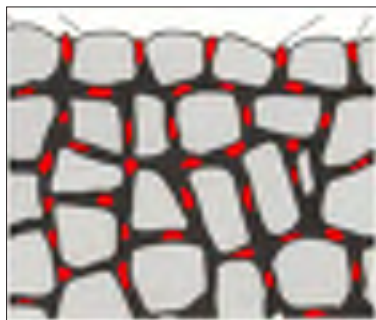


Figure 4 Representative image of the mixture with the added compound

Using this technology it's possible to act on the following parameters:

- The polymeric compound creates a bituminous mastic guaranteeing a reduced emission of the acoustic vibrations generated by traffic;
- The proper granulometric curve studied has the function of creating a proper superficial texture guaranteeing a reduced emission of the rolling noise generated by the tyre-paving contact

#### 4.1 Mix production

The production technique of this technology is similar to the conventional asphalt concrete and it's called "dry method". The compound has to be added directly in the mixer for batching plants, after the hot aggregates or, in case of continuous plants, during the final stage of mixing. The precautions required are the temperature and the mixing time. In fact, the mixing process must take place at temperatures between 170 and 180 ° C to allow the polymeric component to complete its dissolution and facilitate the laying of the modified asphalt concrete.

### 5 CASE HISTORY n° 1: Alessandria province s.p. 82 (Municipality of "Alluvioni Cambiò-Grava") – Noise Reduction

The road SP n° 82 "Spinetta-Sale" passes through the Municipality of Alluvioni Cambiò, that has been built all around this main street (Fig. 5). During the last years people living near this road have put in evidence a problem connected with the traffic noise, certified later by a noise analysis done by ARPA Piemonte (Agenzia Regionale per la Protezione dell'Ambiente – Piemonte Region). This analysis has underlined that the traffic noise in that place is over the limits defined in the regional specifications. In this case the application of noise barriers was not possible because the houses were built close to the street with no space for this type of application. The only possible solution was the noise reduction thanks to the use of a particular technology for asphalt mix with the use of a rubber powder compound and different polymers added directly in the asphalt mixture during the production of the wearing course. The old wearing course has been replaced with this new.



Figure 5 Job site location

Also the speed distribution has been analyzed during the noise registrations and, in the following figure (Fig. 6), it's possible to verify that 50 km/h was the most common speed. This parameter is important because it's connected with the noise frequency.

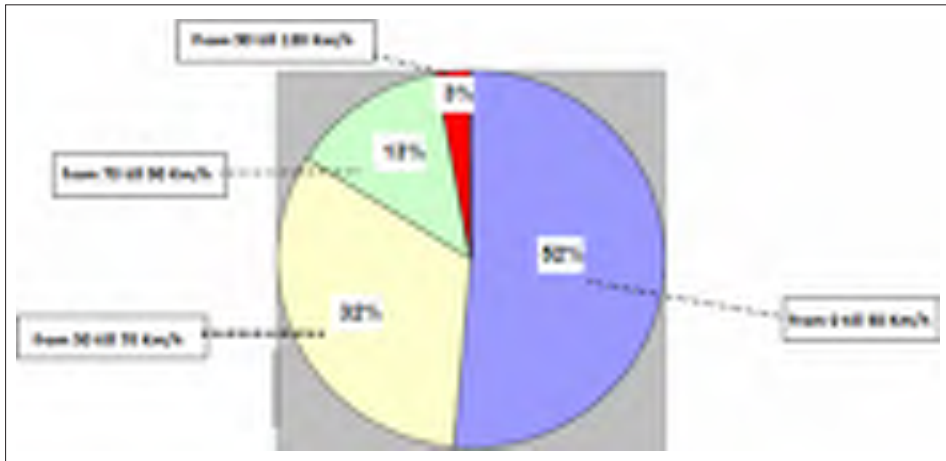


Figure 6 Speed distribution

The noise measured during the analysis has been compared with the limits applied in that area (Fig. 7) and with the results measured after the application of the no-noise asphalt wearing course. In fact the noise analysis has been repeated 6 months after from the application of the asphalt pavement.

STANDARD DPR 30/12/2004	
DAY (6:00 – 22:00) (dB)	NIGHT (22:00 – 6:00) (dB)
70	60

Figure 7 Noise limits for the urban area

## 5.1 Job Mix Formula

The asphalt mix used has been studied with a discontinuous gradation (Fig. 8) and the voids have been filled by the rubber mastic. The final job mix formula has been the following:

- 7,5% Bitumen on the aggregates weight;
- 3% of compound made using rubber powder and different polymers;

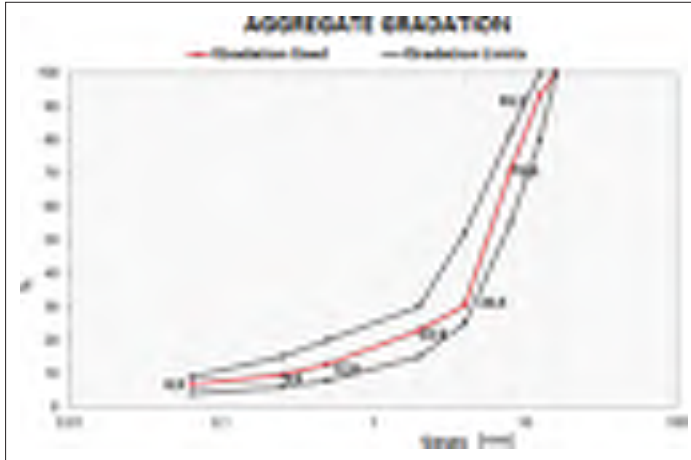


Figure 8 Aggregates gradation

## 5.2 Application of the no-noise wearing course

Some pictures of the application are reported below, Figures 9, 10 and 11:



Figure 9 Laying of the wearing course



Figure 10 Laying of the wearing course and compaction with roller



Figure 11 After the application

### 5.3 Noise Analysis

Before the application of this no-noise wearing course, a lot of noise measurements have been done. Every day the instrumentation has registered the average noise level during the day (from 6.00 am to 10.00 pm) and night (from 10.00 pm to 6.00 am). The microphone has



been located at a high of 3 m near one house as requested from the standard EN 60651 and EN 60804. The results are expressed in dB(A) and they are reported in the following Table 1:

**Table 1** Leq before the application of the new wearing course

	Mon.	Tue.	Wed.	Thur.	Fri.	Sat.	Sun.
Leq, day [dB(A)]	70,4	70,0	69,8	70,3	70,2	69,7	68,2
Leq, night [dB(A)]	64,9	61,7	62,6	62,6	66,0	65,6	86,8

The values in red represent the days when the limit is overpassed. Considering the weekly average, the result is the following Table 2:

**Table 2** Weekly Leq before the new wearing course

	WEEKLY VALUE
Leq, day [dB(A)]	69,8
Leq, night [dB(A)]	64,3

The weekly value was near the limit during the day while it was higher during the night. After 6 months from the application of the wearing course, using the no-noise technology, the noise analysis has been repeated. The results are reported in the following Table 3:

**Table 3** Leq after the application of the new wearing course

	Mon.	Tue.	Wed.	Thur.	Fri.	Sat.	Sun.
Leq, day [dB(A)]	61,5	60,2	62,7	62,6	61,9	60,9	68,2
Leq, night [dB(A)]	53,6	52,5	53,9	51,0	58,4	61,4	59,1

After the application of the new wearing course, only on Saturday night the limit was overpassed. The application has achieved its scope. If we consider the weekly average the result is the following Table 4:

**Table 4** Weekly Leq after the new wearing course

	WEEKLY VALUE
Leq, day [dB(A)]	63,4
Leq, night [dB(A)]	57,2

The weekly situation clearly show the benefits of the application. The limits are respected both during the day and during the night. The most important parameter in order to understand the noise reduction made using the no-noise technology is the difference before the application of the wearing course and after it. The weekly different registered is the following Table 5:

**Table 5** Weekly difference between Leq Before and After the application of new wearing course

	WEEKLY DIFFERENCE
$\Delta$ Leq, day [dB(A)]	- 6,4
$\Delta$ Leq, night [dB(A)]	- 7,1

Thanks to this technology it was possible to reduce the traffic noise of about 7 dB(A). This reduction has clearly shown the benefits of this application in terms of noise pollution for the people leaving around that urban area.

## 6 CASE HISTORY n°2: Novara (Kennedy and Vercelli Streets) – Anti-Vibration Pavement

In order to limit the vibration produced by the vehicle passages, it has been applied a wearing course made following the specification of the no-noise asphalt mixture and using a compound of rubber powder and different polymers directly added into the asphalt mixture. The application has been done in a main road of Novara and it has been monitored using a vibration measurements made by some accelerometers. The location of the project has reported in the following figure (Fig. 12).



Figure 12 Job site location

The phases of realization were the following:

- Laboratory Mix Design Analysis;
- Production and laying of this new asphalt mixture between April and May 2014;
- Monitoring the anti-vibration performance during November 2014 and March 2015.

### 6.1 Job Mix Formula

After the tests of physical characterization, the final grading curve of the asphalt mix has been analyzed in order to determine the correct proportioning of the aggregates according to the grading reference (Fig. 13).

In order to optimize the bitumen content and verify the mechanical performance of the mixture in the laboratory (EN 12697-35) three mixtures have been prepared having different bitumen contents with a fixed percentage of polymeric compound equal to 2.5% on the weight of the aggregates. Especially, we have put in evidence the Indirect Tensile Strength according to EN 12697-23. Above the results achieved (Table 6).

Looking at the results it is possible to observe that the values are nearly equal for all three mixtures (typical behavior of this technology and verified in other experience), the choice of the optimum percentage of bitumen was determined in function of the lower percentage of voids and the greater stiffness: the optimal bitumen percentage is the number 3 in the table above equal to 7,24% on the aggregates weight.

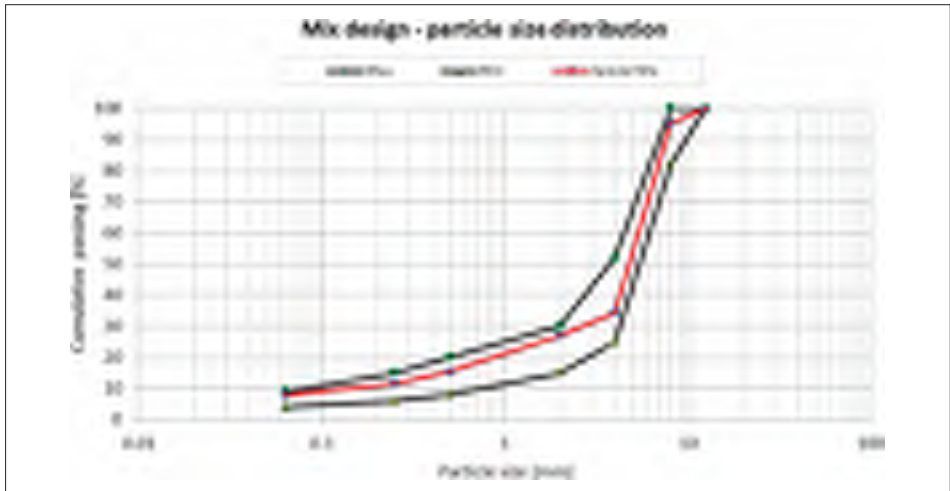


Figure 13 Aggregates gradation used

Table 6 Indirect Tensile Strength at different bitumen contents

Mixture	Bitumen content [% on mixture weight]	ITS [MPa]	CTI [MPa]	Axial displacement [mm]	Specific weight [kg/m <sup>3</sup> ]	Average voids [%]
Limits	6 ÷ 8.5	≥ 0.45	---	---	---	> 2
1	6.39	0.92	53.6	2.613	2428	3.3
2	6.82	0.91	47.5	2.424	2414	3.2
3	7.24	0.88	38.0	3.206	2.411	2.7

## 6.2 Application of the no-noise wearing course

Some pictures of the application are reported here below (Figures 14 to 16):



Figure 14 Laying of the wearing course and compaction with roller



Figure 15 Wearing Course after compaction



Figure 16 Corso Vercelli Street 3 months after construction

### 6.3 Vibration measurements and results

The vibration measurements were made on 23 November 2014 and 31 March 2015 in Corso Vercelli and Via Kennedy located in Novara. Purpose of the reliefs was to certify the pavement from the anti-vibrational point of view, and then compare it to the standard pavement. Both pavements haven't shown any surface damage that could generate abnormal vibration after the passage of vehicles.

The measurement method adopted follows a protocol currently under development that consist of acquisition of the vibration signal with an accelerometer station, which is connected solidly to the road surface analyzed (Fig. 17). The passage of a vehicle creates vibrations on the pavement, that are transmitted to the edge of the road, where they are evaluated through acceleration measurement devices in function of the time.

To overcome the inability to control the variables connected to the source (real traffic), it was chosen to analyze the signal resulting from the passage of two well-known and constant vehicles. The tests were carried out considering the temperatures of the air and of the pavement. The new measurement protocol adopted established that during a single session the vehicles (Vehicle 1 and Vehicle 2) used like reference passes on the lane close to the accelerometer at different speeds. These condition allow to the operator working at the roadside to record several steps, in order to mediate in a post-processing analysis the different conditions of transit and interaction tyre/surface. The same pattern was applied to both pavements.

During the phase of post-processing it has been analyzed the accelerometric signal of each passage, choosing appropriate frequency bands used to evaluate the energy content. The frequency bands have been chosen in function of the energy content of the signal analyzed in narrowband, and respect to what reported in the literature.



Figure 17 Placements of an accelerometer

The frequency bands chosen for the analysis of the accelerometric signals are reported in the following Table 7. The first band can be considered a broad band, including the top 5 narrow bands used.

Table 7 Frequency bands considered for the analysis

Index	1	2	3	4	5	6	7	8
Band [Hz]	8 ÷ 1500	10 ÷ 100	100 ÷ 200	200 ÷ 400	400 ÷ 800	800 ÷ 1500	1500 ÷ 2000	2000 ÷ 3000

The band between 10 Hz and 100 Hz is the bandwidth more interesting from the structural point of view for the pavement vibrations, because it can be influenced by the materials used. The two successive bands are equally important, in fact according to the standard (UNI 9916: 2004) the upper limit of the frequency range affected by the vibrations from road traffic is 300 Hz. The increase of the frequency is caused by phenomena due to the macro-texture of the pavement and by the internal structure.

For each band, it was estimated the total energy of a single event ( $SEL_A$ ), that is calculated in a similar way to the case of acoustic phenomena.

Then it has been calculated the average of the values in  $SEL_A$  obtained for each event for each band, and the dispersion around the peak represents the variability of the phenomenon.

All the results are reported in the following Figures 18 to 21:

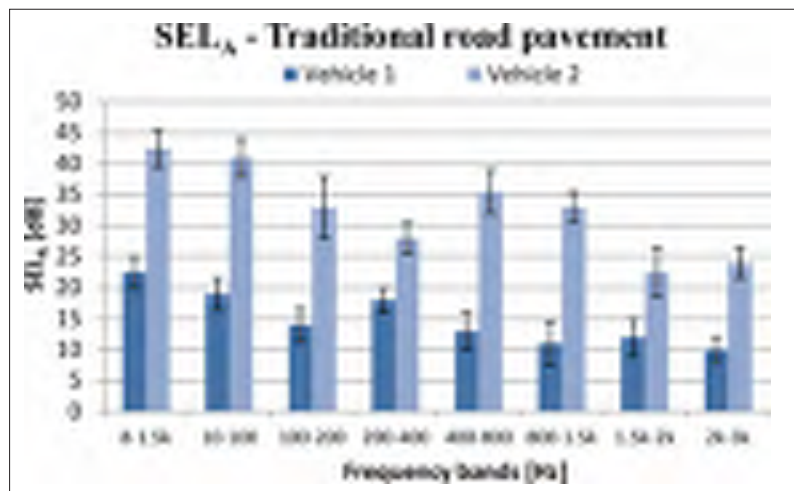


Figure 18 Comparison between the  $SEL_A$  obtained for the traditional pavement for both vehicles

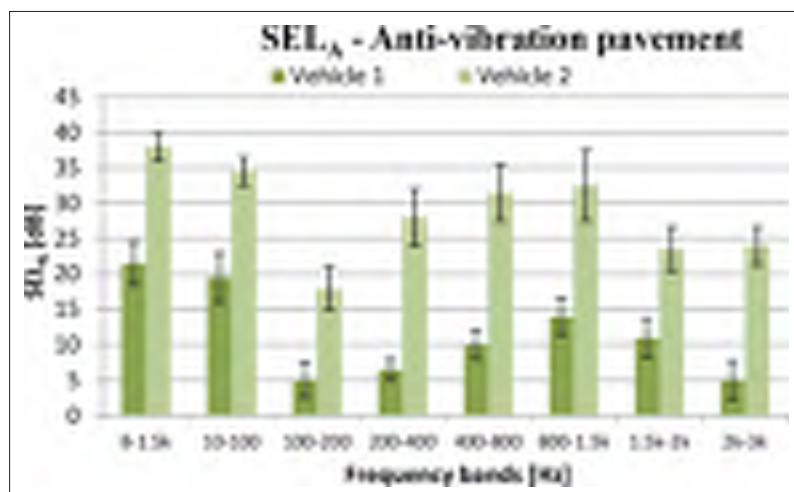


Figure 19 Comparison between the  $SEL_A$  obtained for the anti-vibration pavement for both vehicles



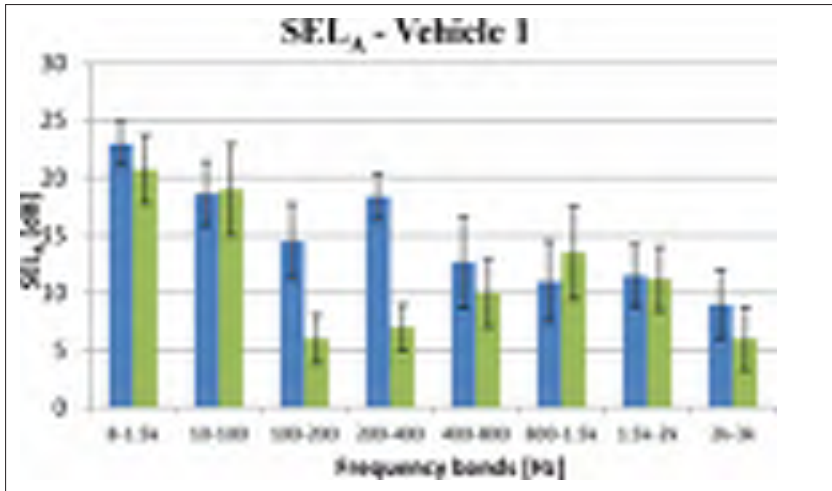


Figure 20 Comparison between the SEL<sub>A</sub> obtained for the Anti-vibration and Traditional pavement for vehicle 1

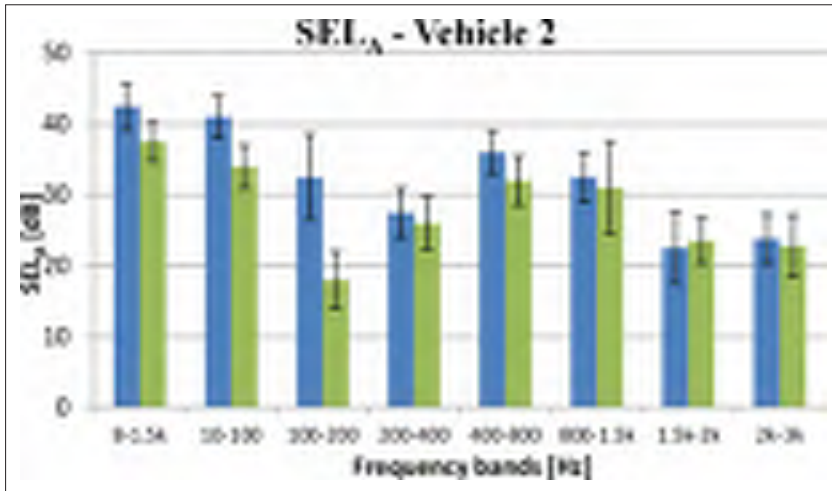


Figure 21 Comparison between the SEL<sub>A</sub> obtained for the Anti-vibration and Traditional pavement for vehicle 2

The uncertainties associated to the values are big due to the few number of steps, that caused an increase of dispersion of the results. The Figures 20 and 21 show for each vehicle, the comparison of the SEL<sub>A</sub> results, between the special pavement and the reference one. After the analysis of the results, some considerations about the relationship between the two pavements investigated can be done:

- for the band 10-100 Hz and for the SEL<sub>A</sub>, the two asphalt pavement have the same behavior considering the Vehicle 1, while with the Vehicle 2 the pavement used as reference has shown lower values in comparison to the pavement with polymeric compound, in fact the difference is about  $-6.6 \pm 3.5$  dB;
- for the band 100-200 Hz the pavement with compound has a lower values in comparison with the reference one for both vehicles;
- for the band 200-400 Hz the pavement with the compound has a lower values;

- all bands which cover the frequency ranges higher than 400 Hz have values not so different between the two pavements, using both parameters for both vehicles.

The final difference between the normal wearing course and the use of a no-noise technology is reported in the following Table 8:

**Table 8** Difference between the normal wearing course and the no-noise layer using different vehicles

Band [Hz]	8 ÷ 1500
Vehicle 1 [dB]	-1.7 ± 3.7
Vehicle 2 [dB]	-4.9 ± 3.8

Using this compound made with rubber powder and different polymers it has been possible to reduce the SEL<sub>A</sub> in an average quantity of about 2 – 5 dB in function of the vehicle used.

## 7 Conclusions

As result of different years of research, the compound contained rubber powder can reduce the noise and the vibration caused by vehicles. Using the road with the modified wearing course, the users perceive this advantage. In fact the anti-vibration component can be seen as direct benefit, but also the noise reduction like indirect benefit. In collaboration with ARPA Piemonte and iPOOL, a spin-off of the Italian National Research Council (CNR), the tests made on the pavement in Alessandria and in Novara have confirmed in objective way the anti-vibration and noise reduction performance. Thanks to a spotted sessions of measurement it's possible to evaluate the influence of different parameters used. Furthermore it's possible to evaluate accurately the effect of the studied mix design and the use of rubber powder on the vibration and noise behavior of the pavement.

The results after different analysis show how it's possible to reduce traffic noise and vibration starting from the asphalt mix project, because we can act on different parameters that can act simultaneously on the noise emission.

## References

- [1] Rumore e Vibrazioni da Traffico – l'Influenza delle Caratteristiche Superficiali delle Pavimentazioni, Associazione Mondiale della Strada – AIPCR – Comitato Nazionale Italiano, 1998;
- [2] Donati, P.M.: Joel's Breaker: forty year of European Vibration Prevention, Institut National de Recherche et de Sécurité, Vandoeuvre Les Nancy, France, – Industrial Health 2012, 50, 370-376;
- [3] Grandi, F.: La progettazione di pavimentazioni antivibranti, Tesi di Dottorato, 2008;
- [4] Formela, K., Haponiuk, J.: Characterization and Properties of LDPE/(Ground TyreRubber)/Crosslinked Butyl Rubber Blends, Journal of Vinyl and Additive Technology;
- [5] Chetoni, M., Teti, L., Bianco, F.: Misure di vibrazione da traffico stradale, iPOOL srl, 2015;
- [6] Indagine sperimentale delle proprietà meccaniche e funzionali di strati di usura "dense – graded" ad emissione acustica ottimizzata per la riduzione del rumore stradale, Tesi di laurea di S. Carrara, 2013;
- [7] Holubka M., Salaiova B.: The use of crushed rubber in asphalt mixtures of road pavements, Civil Engineering Faculty, Technical University of Košice, Slovakia, 2013;
- [8] Coni, M., Silanos, G., Annunziata, F.: Le vibrazioni indotte dalle irregolarità superficiali del profilo stradale, Dipartimento di Ingegneria del Territorio, Università di Cagliari – Convegno Nazionale, Traffico e Ambiente Trento, 21-25 febbraio 2000;
- [9] Thomas, F.: "Suoni variabili nel tempo, attenuazioni del livello sonoro", Lezione XXXIII (disponibile sul web);



- [10] Ferro, R.: Vibrazioni da traffico stradale: caratterizzazione dello spettro di carico, trasmissione alle strutture e valutazione degli effetti dinamici conseguenti, Tesi di Laurea, Università degli studi di Firenze, 1997.
- [11] Carrara, S.: Indagine sperimentale delle proprietà meccaniche e funzionali di strati di usura “dense – graded” ad emissione acustica ottimizzata per la riduzione del rumore stradale, Tesi di Laurea, Politecnico di Milano, 2013.



## ENVIRONMENTAL IMPACT OF TRAFFIC NOISE

Riste Ristov<sup>1</sup>, Slobodan Ognjenović<sup>2</sup>, Ivana Nedevska<sup>1</sup>

<sup>1</sup> *Prostor DOO Kumanovo and GEING Krebs und Kiefer – Skopje, Macedonia*

<sup>2</sup> *University “Ss. Cyril and Methodius”, Faculty of Civil Engineering – Skopje, Macedonia*

### Abstract

The traffic systems, beside their economic and social advantage, have a negative impact as well as sources of significant environmental pollution in the area they are located. During planning and designing of the traffic communication, special attention needs to be paid to strict adherence of certain basic principles on environmental protection. The specificity of this issue can be seen in the multi-dimensional traffic impact on the environment. Regardless whether it concerns a human, an animal in urban surrounding or an animal in nature, the impact of noise is almost the same for everyone. As a consequence of the noise, problems can occur from psychological or physiological aspect, auditory perception might be damaged or lost for everyone. It is certain that the human is most resistant to the noise, so it can easily adjust and protect from the same. Most unfavourable impact the noise would have on animals in nature, for which the overexposure to noise would have extensive consequences both for finding food and reproduction. As follows, this paper will include the impacts and consequences of overexposed traffic noise on the environment.

*Keywords: traffic systems, exposure, noise, human, environment*

### 1 Introduction

Noise is an unpleasant and unwanted external sound, created by human activities, which is imposed onto the environment creating discomfort and disturbance. The most influential sound disturbances in the environment are the industrial and urban noise. Industrial noise is created by the surrounding industrial facilities whereas urban noise originates from traffic and the other contents of an urban area generating unwanted sounds. Urban environment is especially characterized by traffic noise mainly affecting human population. Besides being a nuisance in people's activities, disturbing them while they work, this noise type bothers them out of their professional working hours, at their homes and during rest, and especially at night. The increase of motorisation level intensifies traffic noise. This problem is especially present in cities without an adequate roundabout and without an appropriate solution of the urban traffic flow. Unplanned development, planning of large investment projects of modern highways, the large traffic flow through narrow streets and the low pavement quality results in a condition of considerable increase of noise in urban areas.

### 2 Influence of noise on people

The reactions of the human body to noise are not the same in each individual. They depend not only on the personal sensitivity to sound, but also on the period of exposure and on the intensity and character of the noise.



**Figure 1** Critical health effects from noise

Each person senses and perceives sounds differently; similarly, each person withstands the sound intensity differently. This depends on the age of the person, on some innate deficiencies in the ear structure, as well as on shortcomings resulting from injuries and diseases. Human ear is adapted to receive sounds of 16 of 20 000 Hz frequencies. It is most sensitive to the high frequencies of 1 000 to 3 000 Hz, even to those of 5 000 Hz which are the most audible ones. The lowest sound intensity capable of causing sense of sound is called absolute threshold of hearing. The lowest intensity capable of causing pain is called pain threshold. The area between the hearing threshold and the pain threshold is called audible field. There is not consent on the noise level that leaves adverse influence of human organism in the world, but it has been generally accepted that noise of over 85 dB (A) already has negative impact on the hearing sense.

## 2.1 Psychological influence of noise

The psychological interpretation of noise and its impact on people cannot be defined by laws, or measured by instruments. The psychological impressions are assessed as pursuant to people's reactions, which are differently manifested and narrowly related to the nervous system and the person's psychological condition. Typical for the psychological influence of noise is the fact that the same noise is sensed differently by different individuals: some perceive it as noise and some as pleasant sound or bearable noise. From the psychological aspect, noise leaves its impact on memory capacity, on the numerical and verbal intelligence on the capacity of spatial orientation and reasoning (2).

## 2.2 Physiological influence of noise

The physiological influence of noise on people is a complex one, due to the functional correlation and the complexity of the organs. The impact of noise on people and their body organs is presented from the spectrum aspect.

### 2.2.1 Influence of noise from the hearing spectrum

The hearing spectrum noise influences several systems of the human body: the central nervous system, voice and speech, cardiovascular system, the internal secretion glands, the equilibrium system, the organ of sight, the blood chemistry, the electrolyte balance and the digestive system.

### 2.2.2 Influence of the noise from the infrasound range

Infrasound is relatively frequent in nature and it does not damage human health to a certain level of intensity. Disturbances due to infrasound are manifested by unstable movements, dizziness and lack of concentration. The said disturbances of the general condition of the organism is characterized by fatigue, apathy and reduction of work capacity. All these symptoms disappear shortly after the sound is interrupted.

### 2.2.3 Influence of the noise from the ultrasound range

Ultrasound can hardly travel through air, but can pass through fluids and solid bodies much more easily. This noise results in balance disturbances, headaches, dizziness, sleepiness, sleep disorders, irritability, increased temperature, increased sound sensitivity etc.

### 2.2.4 Influence of vibrations

Vibrations are low-frequency oscillations which usually create noise. Changes and disturbances incur when the oscillations have higher velocity and acceleration. Low-frequency vibrations influence the muscles and their tendons as well as the blood vessels resulting in different levels of damages.

## 2.3 Influence of the sound volume

The influence of noise on human organism can be classified into four levels depending on the sound volume:

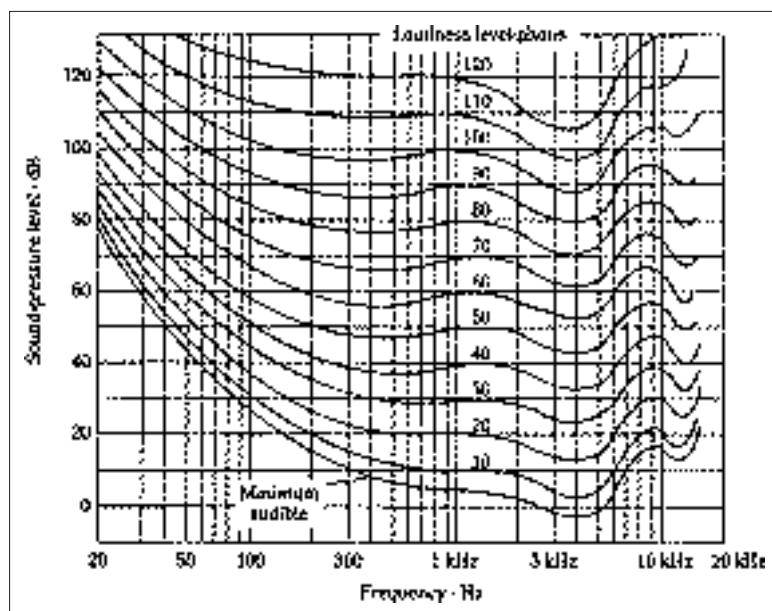


Figure 2 Curves of the same volume (12)

- The area from zero to 30 phones is considered as absolutely harmless
- First level: from 30 to 60 phones leaving psychological impact
- Second level: 60 to 90 phones triggers changes in the vegetative nervous system. This results in a psychological and emotional impact, manifested in mental fatigue.
- Third level: from 90 to 120 phones triggers rapid physical and vegetative reactions and endangers the hearing system, causes heart and blood vessel diseases, as well as sense of thirst and swallowing difficulties.
- The fourth level of noise is higher than 120 phones, causing intensified changes of the third level, including skin damage, damage of the mucous membranes and of the nerve endings.

## 2.4 Influence of the sound frequency

Human hearing system is capable of receiving frequencies ranging from 16 to 20 000Hz. The frequency sensitivity limits vary depending on the individual, their age and the physiological condition of the hearing organs. The infrasound's influence by sound pressure which leaves its consequences on the entire body and they are felt on the bones and the muscles, impeding the basic human reflexes. On the other hand, ultrasounds have thermal influence, attacking the sensitive nerve endings of the skin and of the mucous membranes endangering all the parts of the inner ear.

## 3 Influence of noise on the living beings

The influence of intensive noise is different in domestic and in wild animals. Domestic animals react to noise similarly as people, as they live in the same location and share the same environment. Although they are more exposed to noise than the wild animals, their mortality rate is considerably lower. The noise exposure mostly influences their fertility rate, indirectly decrease the yield of regarding certain agricultural products. The gradual increase of the noise level in quiet natural areas dictates that the animals should either adapt to the new acoustic condition or leave. Over-exposure to noise in nature can largely complicate activities such as communication or navigation. The main results of excessive noise in nature are the hearing impediment and sudden increases in heart rate. Their reduced sense of hearing can make them into an easy prey and classify them among the endangered species. Also, in case of predators, impeded hearing can render them less able to hunt, resulting in the disturbance of the eco-system balance (13).

## 4 Influence of noise on plants

The number of researches estimating the effects of noise on the flora has recently increased. Noise influences plants indirectly, by affecting animals first. This is most visible in the areas with low wind intensity where the main fertilizers are certain types of insects and birds that disseminate the pollen. Great noise impact can be observed upon the sowing of some types of plants and trees where the seed is dispersed by rodents and insects that store seeds in the soil. On some tree types the influence of noise can be a long-lasting one, leaving its effects even after being completely eliminated, as noise delays the growth of such trees and thereby increases the time necessary for other ones to grow (15).

## 5 Conclusion

The rapid increase of high-velocity roads, as well as of water and air traffic makes the world an ever louder place to live. Therefore, it is clear that the overall traffic noise will leave important impact on the environment. This incites the opinion that the influence of noise is equal for all living beings. Although the most exposed to noise, people and domestic animals best adapt

to it and are most often the subject of the measures taken in view of anti-noise protection. The wild animals are less influenced but the measures taken for their protection against noise are the fewest.

There is no place in the world where it is possible to establish complete isolation against artificially created noise. The result is the fact that even the most affected animals do not have anywhere to move or to hide from it. This leads to extinction of certain animal species and forced adaptation of, unfortunately, the fewer of them.

## References

- [1] Dixon Ward, W.: Auditory After-effects of Noise, SCOPE 24, Noise Pollution, Chapter 7, pp. 201-223 (1986)
- [2] Jansen, G., Gross, E.: Non-auditory Effects of Noise: Physiological and Psychological Effects, SCOPE 24, Noise Pollution, Chapter 8, pp. 225-247 (1986)
- [3] Miller, J.: Effects of Noise on People, US Environmental Protection Agency, (1971)
- [4] Singh, N., Davar, S.C.: Noise Pollution- Sources, Effects and Control, J. Hum. Ecol., 16(3): pp. 181-187 (2004)
- [5] Health effects of exposure to ultrasound and infrasound. Documents of the Health Protection Agency, Series B: Radiation, Chemical and Environmental Hazards, (2010).
- [6] Omubo-Pepple, V.B., Briggs-Kamara, M.A., Tamunobereton-ari, I.: Noise pollution in port harcourt Metropolis: sources, effects and control, Working and Living Environmental Protection, 7 (2010) 1, pp. 33-42. (2010)
- [7] Bond, M.: "Plagued by Noise", New Scientist, pp. 14-15, (16 Nov. 1996)
- [8] Berglund, B., Hassme, P.: Sources and effects of low-frequency noise, J. Acoust. Soc. Am. (1996); (5) pp. 2985-3002.
- [9] Goines, L., Hagler, L.: Noise Pollution: A Modern Plague, Southern Medical Journal, 287-293 (March 2007)
- [10] Evans, G.W., Lepore, S.J.: 'Nonauditory effects of noise on children' Children's Environment, Vol. 10, pp. 31-51 (1993)
- [11] Griefahn, B: Noise Pollution during the Night – A Possible Risk Factor for Health, SCOPE 24, Noise Pollution, Chapter 10, pp. 265-282 (1986)
- [12] Fletcher, H., Munson, W.A.: "Loudness, its definition, measurement and calculation", Journal of the Acoustic Society of America 5, pp. 82-108 (1933)
- [13] Mancini, K.M., Gladwin, D.N., Villeda, R., Cavendish, M.G.: Effects of aircraft noise and sonic booms on domestic animals and wildlife 1988.
- [14] Understanding Noise Pollution, <http://www.conserve-energy-future.com/causes-and-effects-of-noise-pollution.php>
- [15] Noise pollution affects pollination and chances of seed germination [http://ec.europa.eu/environment/noise/index\\_en.htm](http://ec.europa.eu/environment/noise/index_en.htm), 31.05.2012.





## MONITORING OF DYNAMIC PROPERTIES OF NEW TYPE OF TRAM TRACK FASTENING SYSTEMS UNDER TRAFFIC LOAD

Ivo Haladin<sup>1</sup>, Stjepan Lakušić<sup>1</sup>, Janko Koščak<sup>2</sup>, Marko Bartolac<sup>2</sup>

<sup>1</sup> University of Zagreb, Faculty of Civil Engineering, Department for Transportation Engineering, Croatia

<sup>2</sup> University of Zagreb, Faculty of Civil Engineering, Department for Engineering Mechanics, Croatia

### Abstract

Light rail and tram traffic present significant advantages in a heavy populated urban environment in terms of quality of service, volume of passengers, delays etc. Rail vehicles in interaction with a railway structure, however, can induce vibrations that are propagating to surrounding structures and cause noise disturbance in the surrounding areas. Since tram tracks often share the running surface with road vehicles it is also of most importance to construct long lasting and low maintenance structures in short traffic closure periods foreseen for these activities.

Tram system forms a backbone of public transport in the City of Zagreb. In the last decade, its fleet has been renewed by 142 new low-floor trams. Shortly after their introduction, it was observed that they have a negative impact on the exploitation behaviour of tram infrastructure, primarily on the durability of rail fastening systems. To tackle this challenge, improvements to the standard fastening systems on Zagreb tram network have been proposed. New fastening systems 21-CTT and 2 21-STT have been installed for testing purpose in Savska street in Zagreb on a 150 m long test section, along with the referent test section of standard ZET fastening system PPE (fastening system with enhanced resilience).

Paper presents an overview of the newly implemented fastening systems, their implementation on a test section in Savska street, as well as measurements and analysis of strain in RC slab and rail vibrations driven by tram pass-by.

*Keywords: tram track, 21-STT, 21-CTT, vibrations, strain*

### 1 Introduction

In the last decade, systems manager Zagreb Electric Tram Ltd (ZET) has renewed its fleet by purchasing 142 new low-floor trams TMK 2200, changing the conditions on the tram network in terms of power demand, loads transferred to the track, wheel-rail interaction mechanism etc.. Shortly after the introduction of new low-floor trams, it was observed that this fleet modernization has increased exploitation demands on other components of tram infrastructure [1]. i.e. the power supply system and track superstructure. These changes in tram track exploitation parameters have caused more frequent rail fastening system failures, which reflected in the increased rail wear and accelerated track geometry degradation. In event of such mayor rolling stock renewal, track structure parameters have to be evaluated [2], [3] and modified. Because of that, ZET Ltd has decided to adjust existing rail fastening systems to the new track exploitation conditions. This was done through technical collaboration with the University of Zagreb Faculty of Civil Engineering, considering the vast experience and expertise in design and supervision of railway and tram track structures.



When developing any new rail track system, after careful design reviews, component testing etc. it was decided to conduct monitoring of new fastening systems exploitation behaviour. This was done by construction of the test track section with built-in new fastening systems [4]. On it, the following continuous and periodic measurements were made:

- visual inspections of track superstructure,
- measurements of track and weld geometry,
- measurements of stresses and strains of tracks reinforced concrete foundation slab, and
- measurements of the tracks dynamic properties (i.e. vibration damping).

## 2 Characteristics of new fastening systems

The primary role of the rail fastening system is positioning and fixing of the rails and transferring the vehicle load from the rails to the track substructure. Generally, the type and characteristics of fastening system is chosen depending on the required elasticity of the track, planned load and type of rail. On major part of Zagreb tram tracks, grooved rails are discretely laid on the levelling layer, made out of micro synthetic concrete, built on reinforced concrete slab. Standard fastening system used on a large part of ZET tram network is indirect elastic fastening system with decreased stiffness PPE (Figure 1.b) with 50 MN/m stiffness, developed during the 1990s in order to increase tram track life span, and used on about 15% of network. This and other commonly used track fastening systems (ZG 3/2 and DEPP) reflect state of the art and demands for exploitation from the beginning of 1990s which do not meet today's highly complex exploitation requirements on Zagreb's tram tracks:

- large tram traffic volume (individual sections of Zagreb's tram tracks have a traffic volume of up to 15 million gross tons per year),
- high vehicle passing frequency (vehicle frequency is less than 90 s on individual sections),
- high wheel loads on low-floor trams (more than 3.5 tons per wheel),
- strict tolerances regarding the narrow, 1000 mm gauge, track geometry.

Based on the above requirements, during the last few years the Faculty has developed five different concepts for new fastening systems. Two of them, with working titles 21 CTT (Classic Tram Track – the name was chosen because the structure of the system is an upgrade of the existing indirect elastic systems) and 21 STT (Slab Tram Track), were chosen for further development. Their characteristics, production requirements and installation methods best match previous experiences in the construction and maintenance of tram tracks in Zagreb.

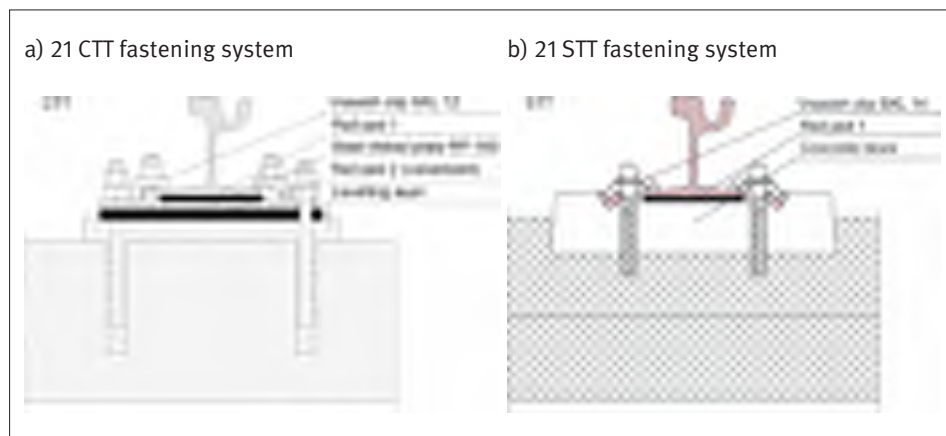
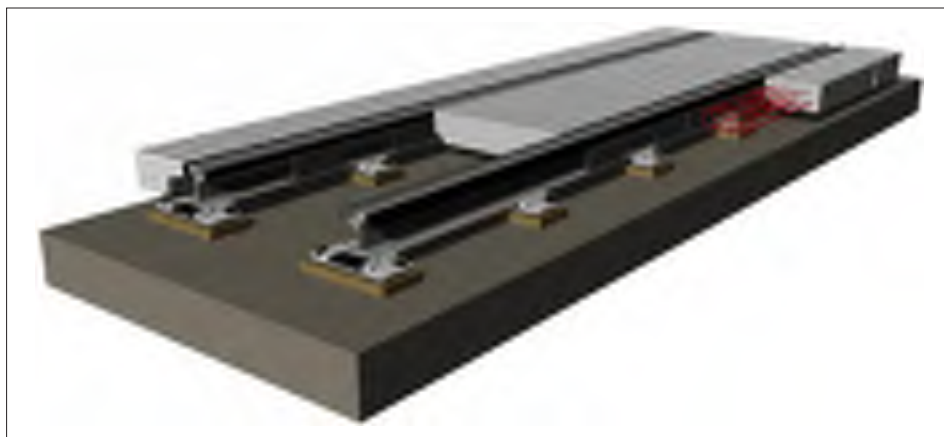


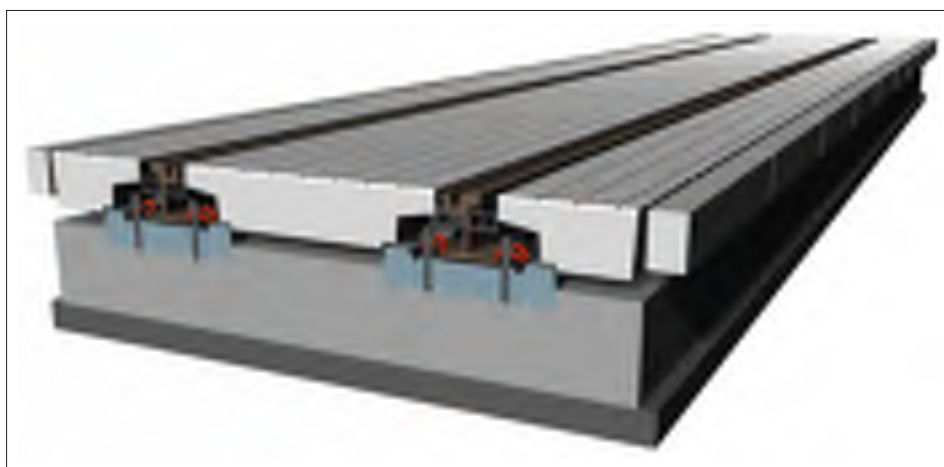
Figure 1 Schematic cross sections of rail discrete bearings with 21 CTT and 21 STT fastening systems

21 CTT system (Figure 1.a) places the rails discreetly on the levelling layer, made out of micro synthetic concrete, built on reinforced concrete slab (Figure 2.). The distance between supports is one meter in the tram rolling direction. The rail foot is supported by neoprene pads placed on ribbed steel plate, laid on the levelling layer. To ensure the durability of individual components and ease the installation during construction and dismantling during the track reconstruction, the underside of the ribbed steel plate is fitted, by vulcanization process, with elastic pad. Vulcanization process enabled production of a compact element electrically isolated from other components (anchors), but also provided for additional elasticity of the whole fastening system.



**Figure 2** Design model of tram track structure with 21 CTT fastening system

21-STT system (Figure 1.b) represents a completely new solution for tram tracks superstructure construction in Croatia. Its main advantage over the previous systems is that the levelling layer (which is quite difficult to construct) are replaced by two block precast concrete sleepers laid on reinforced concrete base slab, one meter apart (Figure 3.). Upper reinforced concrete slab is constructed after track horizontal and vertical alignment adjustment. This is a direct elastic fastening system, with one elastic pad between the rail foot and block sleeper.



**Figure 3** Design model of tram track structure with 21 STT fastening system

### 3 Construction of test section and

In order to determine exploitation characteristics of newly developed tram track fastening systems and get detailed insight into the behaviour of its elements and the track structure as a whole, in the spring of 2014 a plan and program of test track section construction and monitoring in Savska Street was adopted. The said track section was, according to track maintenance program, planned for reconstruction due to its deterioration. For the purpose of the research, the section was divided into three sub-sections. The first sub-section is designed as a reference and reconstructed using the standard PPE fastening system. The second reconstructed sub-section is fitted with a 21 CTT fastening system, and the third is reconstructed as 21 STT system (Figure 4).

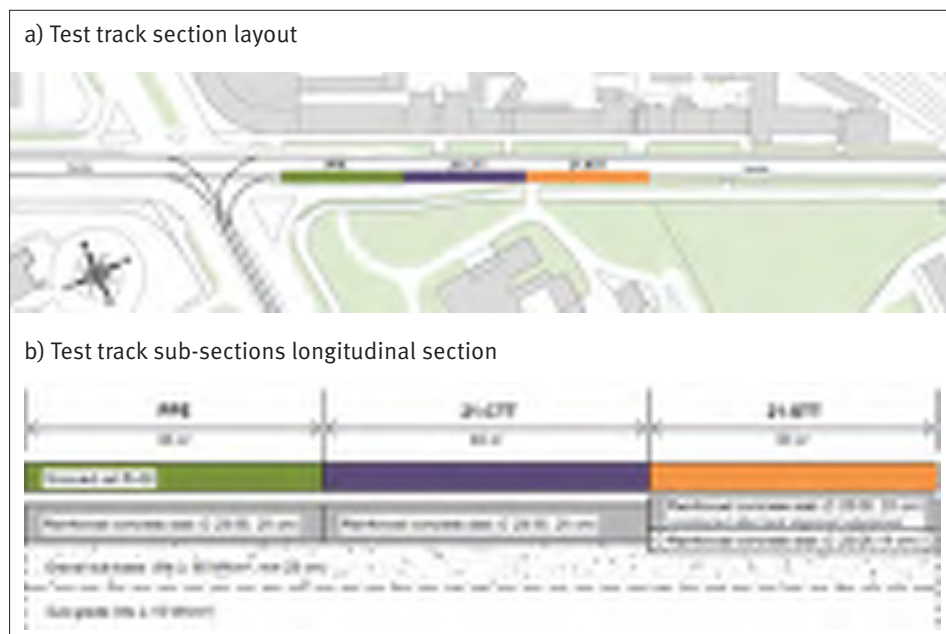


Figure 4 Test track section in Savska Street

A brief overview of construction work on subsections can be observed in Figure 5. Demolition of old track (a), construction of the new mechanically compacted base layer (b), construction of new reinforced concrete slab and fitting of strain gauges (c), construction of the bearings with fastenings and rail mounting (d, e), casting the top concrete slab to cover block sleepers of 21-STT (f).

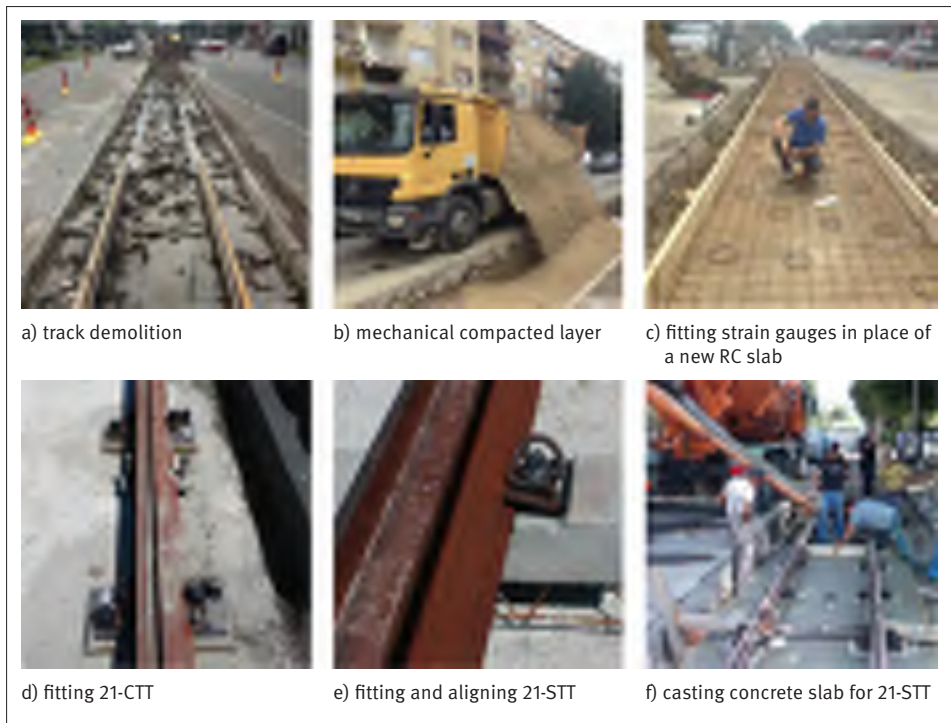


Figure 5 Construction steps at test section in Savska street

#### 4 Tram track strain and deformation monitoring

During the construction process of test section, strain gauges have been fitted inside the bearing reinforced concrete slab. Total of 12 sensors have been fitted, 4 at each subsection (PPE, 21-CTT, 21-STT), of which two in longitudinal and two in lateral direction. Sensors have been fitted to the tensile zone of the slab, attached to reinforcement and afterwards covered in concrete. Sensors cabling has been installed up to a revision shaft on the side of the track, where the data collection system MGC+ could be connected at any time without interrupting traffic. By detecting change in voltage, sensors read the relative deformation of reinforcement. With presumption that the reinforcement is properly anchored in concrete slab, and with known modulus of elasticity of concrete, strain can be expressed in the bottom zone of RC slab.



Figure 6 Position of strain gauges on reinforcement rod – 21-STT

Strain reading on the bottom of concrete slab is a good indicator of load distribution through the track structure, influence of dynamic load on the lifespan of structure and possible cracks in the track structure. Strain measurements have been conducted under dynamic load of empty vehicle TMK 2266 pass by at the speed of 15 km/h and 30 km/h which are to be expected at this section. Data has been collected with sampling frequency of 50 Hz, giving a strain reading every 0.02 sec. Measurement results are shown in Table 1, where the overview of maximum strain readings of track structures is presented (for PPE, 21-CTT and 21-STT) for tram speed of 30 km/h.

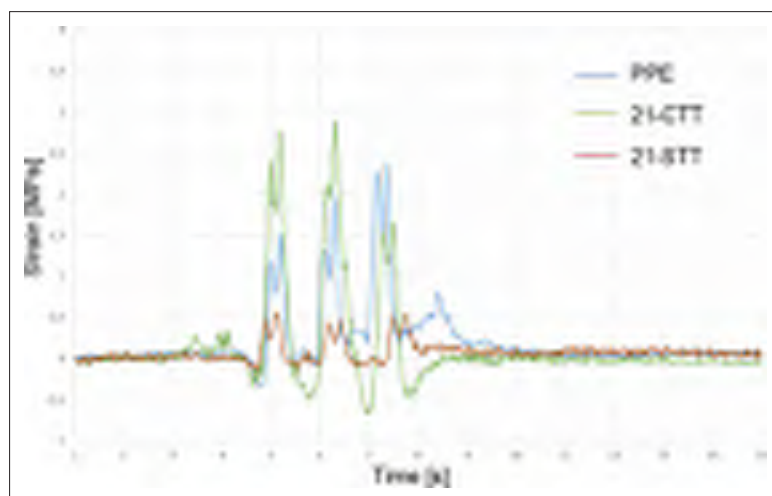


**Figure 7** Conducting strain measurements section 21- STT (left) and vibration measurements at section 21-CTT (right) under vehicle pass by

**Table 1** Values of strain readings in bottom zone of RC slab

Maximum strain reading [MPa]						
Section	PPE		21-CTT		21-STT	
Direction	LONG	LAT	LONG	LAT	LONG	LAT
24.11.2014.	2,38	1,87	2,89	3,33*	0,56	0,73
04.03.2015.	3,33	2,25	2,26	1,14	0,86	1,01

*\*sensor is located near a rail weld of poor geometry so additional strain is to be expected*



**Figure 8** Time record of strain under vehicle pass by at PPE, 21-CTT and 21 STT, longitudinal direction

By comparing the continuous time record of strain at all subsections (Figures 8 and 9) it is evident that 21-STT structure has very good load distribution to lower structure layers. Strain in this structure is around 3 times smaller than the other two observed subsections. It is also visible that structures 21-CTT and PPE have similar strain measurements, as it was to be expected since similar fastening elements have been used.

## 5 Vibrations measurements

The main sources of noise and vibrations on rail tracks are the propulsion noise of locomotives and power cars coming from the engines, aerodynamic noise that occurs at very high train speeds, and wheel/rail interaction. The latter is the main noise and vibrations source in urban rail traffic, where the vehicle speed is not high enough to take into account aerodynamic noise [5]. When vehicles run on the tracks, their weight coupled with the dynamic forces resulting from running surface irregularities causes oscillations i.e. vibrations of rail vehicles and whole track construction. At high frequencies (100-5000 Hz), the energy of these vibrations is propagated through the air in the form of sound waves (noise). Lower frequency vibrations (0-100 Hz) are transmitted from rails to the lower parts of track structure and surrounding soil [6]. On test track in Savska Street, vibrations have been measured under tram traffic load in order to establish attenuation property of the subsections. Pass-by vibration measurements have been conducted under constant speed of 30km/h of an empty tram, garage number TMK2266. This measurement setup has been used in order to establish unified excitation of vibrations during the experiments.

### 5.1 Measurement procedure

To determine dynamic properties of a railway track, vertical and lateral vibrations have been measured under vehicle pass-by. Accelerometers for vibration measurements have been fixed to the rail by means of magnet, and the access to the rail has been ensured by installing revision shafts near the rail while constructing the test section, Figure 9.



**Figure 9** Acceleration sensor fixed to rail foot and rail web, inside a revision shaft

Measured vibration signal is recorded in time domain and can be observed simultaneously for different test sections, Figure 10. Peaks in the diagram correspond to wheel pass by over the microphone.



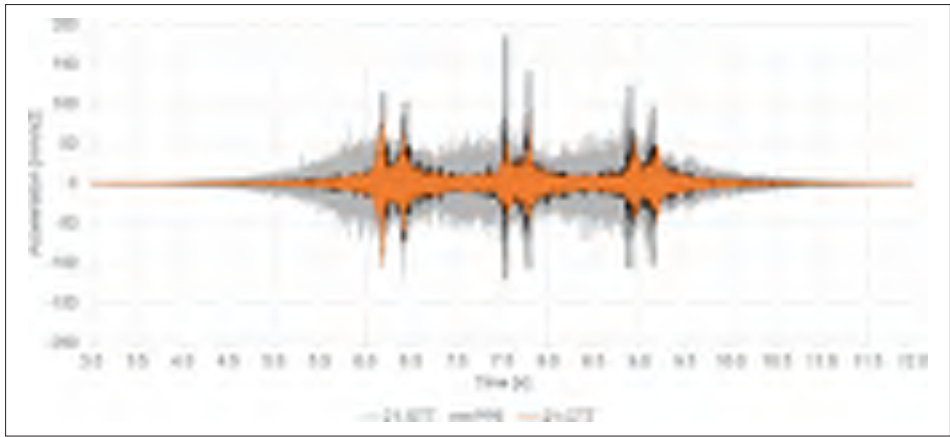


Figure 10 Time signal of recorded rail vibrations in vertical direction on all three subsections

### 5.2 Data analysis

To quantify the level of vibrations, the expression of equivalent vibration level,  $L_{Veq}$ , has been calculated according to:

$$L_{Veq} = 10 \log_{10} \left[ \frac{\frac{1}{T} \int_{t_1}^{t_2} V^2(t) dt}{V_0^2} \right] \text{ dB} \tag{1}$$

Where:

- $V^2$  – level of vibrations,
- $V_0^2$  – referent vibration level of  $1 \mu\text{m}$ ,
- $T$  – time interval [7].

Using formula (1), equivalent levels of vibrations have been expressed for each subsection, Table 2

Table 2 Equivalent level of vibrations during a tram TMK 2266 pass by at 30 km/h

	PPE	21-CTT	21-STT
$L_{Veq}$ (dB)	117.0	114.5	122.6

From calculated equivalent vibration levels of a tram pass-by (interval of 9 sec) it can be concluded that in respect to referent subsection PPE, section 21 CTT has achieved reduction of vibrations by 2.5 dB, while subsection 21 STT measures increase in vibrations of 4.6dB. This increased vibration level can be prescribed to stiffness of the whole track structure on 21-STT section which could be reduced by adding different under rail pads.

### 6 Conclusion

Due to high traffic loads, tram tracks in the City of Zagreb are exposed to high stresses, they rapidly degrade and deteriorate. To answer the harsh tram traffic operation conditions, and to optimize maintenance procedures, two new solutions for rail fastening systems were developed, named 21-CTT and 21 STT systems. The main objective in developing the new systems

was to develop a tram track structure which would be quick and simple to construct, have longer exploitation life, be easy to maintain, and have good exploitation characteristics. By measuring and analysing dynamic properties under vehicle pass by-at constant speed, it can be concluded that 21-STT shows significant reduction of strain measured in bottom layer of concrete slab, because of better load distribution through the structure. Vibration attenuation, measured by determining rail vibrations, under tram pass-by at constant speed shows reduced level of vibration on 21-CTT section in respect to referent section PPE, as a result of carefully selected vulcanized elastic elements of rail fastenings. 21-STT however shows a higher level of vibrations due to a much stiffer under rail pad and overall track stiffness, which can be reduced by introducing different elastic fastening elements.

## Acknowledgment

This work was supported by the Ministry of Science, Education and Sports of the Republic of Croatia within the framework of the Scientific Project 'Noise and Vibrations on Tram and Railway Tracks' (Grant Number 082-0000000-2185). The authors would also like to express sincere gratitude to the ZG Holding d.o.o. – ZET, Edilon)(Sedra HmbH, Beton Lučko d.o.o, DIV Group d.o.o. Gumiimpex-GRP d.d., Georad d.o.o., PGP d.o.o. for the financial and technological support given to this study.

## References

- [1] Ahac, M.: "Mehaničko-empirijski model promjene širine tramvajskog kolosijeka tijekom eksploatacije," University of Zagreb, 2013.
- [2] Tomičić-Torlaković, M., Čirović, G., Mitrović, S., Branković, V.: "Optimisation and ranking of permanent way types for light rail systems," *Gradevinar*, vol. 66, no. 10, pp. 917–927, 2014.
- [3] Jovanović, S., Guler, H., Čoko, B.: "Track degradation analysis in the scope of railway infrastructure maintenance management systems," *Gradevinar*, vol. 67, no. 3, pp. 247–257, 2015.
- [4] Lakušić, S., Haladin, I., Koščak, J.: "Izveštaj o monitoringu sustava pričvršćenja tramvajskog kolosijeka Zagreb 21-CTT i Zagreb 21-STT na Savskoj cesti u Zagrebu," Zagreb, 2015.
- [5] Hemsworth, B.: "STAIRRS – Strategies and Tools to Assess and Implement Noise Reducing Measures for Railway Systems – Final technical report," 2003.
- [6] Esveld, C.: *Modern railway track*, Second edi. Delft: TU Delft, 2001.
- [7] Thompson, D.: *Railway Noise and Vibrations*. Elsevier Ltd, 2009.





## 13 INNOVATION AND NEW TECHNOLOGY





## A MULTI-OBJECTIVE OPTIMIZATION-BASED PAVEMENT MANAGEMENT DECISION-SUPPORT SYSTEM FOR ENHANCING PAVEMENT SUSTAINABILITY

João Santos<sup>1</sup>, Adelino Ferreira<sup>1</sup>, Gerardo Flinstch<sup>2</sup>

<sup>1</sup> University of Coimbra, Department of Civil Engineering, Research Center for Territory, Transports and Environment, Road Pavements Laboratory, Portugal

<sup>2</sup> Virginia Polytechnic Institute and State University, The Charles Via, Jr. Department of Civil and Environmental Engineering, Virginia Tech Transportation Institute, Center for Sustainable Transportation Infrastructure, VA, USA

### Abstract

In a society where the public awareness of environmental protection is increasing remarkably and the availability of resources and funding is limited, it is more vital than ever that departments of transportation and decision-makers seek new tools that enable them to make the best and most rational use of these resources, taking into account environmental and social factors, along with economic and technical considerations. However, the practice adopted by highway agencies with regards to pavement management, has mostly consisted of employing life cycle costs analysis (LCCA) systems to evaluate the overall long-term economic efficiency of competing pavement design and maintenance and rehabilitation activity alternatives. This way of supporting the decision-making process as it relates to pavement management, in which little or no importance is given to environmental considerations, does not seem to be effective in advancing sustainability in pavement systems. To address this multifaceted problem, this paper presents a comprehensive and modular multi-objective optimization (MOO) based pavement management decision-support system (DSS) which comprises three main components: (1) a MOO module; (2) a comprehensive and integrated pavement life-cycle costs – life-cycle assessment (LCC-LCA) module that covers the whole life cycle of the pavement; and (3) a decision support module. The potential of the proposed DSS is illustrated with one case study consisting of determining the optimal M&R strategy for an one-way flexible pavement section of a typical Interstate highway in Virginia, USA, which yields the best trade-off between the following three often conflicting objectives: (1) minimization of the present value (PV) of the total life-cycle highway agency costs; (2) minimization of the PV of the life-cycle road user costs; and (3) minimization of the life-cycle greenhouse gas emissions.

*Keywords: pavement management, life cycle cost analysis, multi-objective optimization, decision-support system*

### 1 Introduction

Current asset management practices adopted by transportation agencies consist of applying economic analysis techniques, such as the life cycle costs analysis (LCCA), to select from among various infrastructures designs and/or maintenance and rehabilitations (M&R) intervention alternatives those that are most economically appealing, according to their interests and existing constraints. However, recent recognition that transportation infrastructure management decisions and practices also have substantial impacts on the environment [1], along with the

increasing awareness of sustainability and climate change, have motivated governmental agencies to promote a shift in focus in the management of transportation infrastructures towards achieving sustainable transportation systems. In the particular case of the road pavement sector, the implementation of effective sustainable pavement management systems requires the development of approaches that enable the prediction of: (1) the pavement performance; (2) the construction and maintenance-related budget requirements; and (3) the costs incurred by road users and (4) the environmental impacts related to the pavement life cycle, using appropriate performance measures. While LCCA provides an effective evaluation to pinpoint cost effective solutions for the design and maintenance of pavement systems [2], the environmental impacts associated with their life cycle are best characterized using a life cycle assessment (LCA) approach [3]. Despite the recognized merits of LCCA and LCA methods in evaluating the economic and environmental dimensions of sustainability, these methods applied individually are inefficient to optimally address the common trade-off of relationships and interactions between life cycle sustainability indicators. Rather, they are better employed when integrated into an optimization-based pavement life cycle management framework accounting for various objectives and constraints, and allowing LCCA and LCA to be carried out in parallel. However, the traditional practice in optimized decision-making in pavement management has been based on the optimization of a single objective, mostly the minimization of LCC, which can be either the total highway agency costs (HAC) or, less often, the summation of the total HAC and road user costs (RUC). It is therefore evident that a steady and effective implementation of a sustainable pavement management system, through the addition of the environmental dimension to the traditional cost-based optimization framework, requires the mathematic formulation of the decision problems to migrate from the single-objective optimization to the multi-objective optimization (MOO) domain, in which the decision makers (DMs) are provided not with one single preferred solution, but with a set of potentially preferred solutions.

The objective of the present paper is to present a comprehensive and modular MOO-based pavement management decision-support system (DSS) for enhancing pavement sustainability. The main novelty of the DSS lies in the incorporation of a comprehensive and integrated pavement LCC-LCA model, along with a decision-support module, within a MOO framework applicable to pavement management. The aims of the DSS are twofold: (1) to enhance the sustainability of the pavement management policies and practices by identifying the most economically and environmentally promising pavement M&R strategies, given a set of constraints; and (2) to help DMs to select a final optimum pavement M&R strategy among the set of Pareto optimal pavement M&R strategies.

## 2 Decision support system methodology

The methodological framework of the DSS comprises three main modules: (1) a MOO module; (2) a comprehensive and integrated pavement LCC-LCA module; and (3) a decision-support module. The MOO module is further divided into three subcomponents: (i) the formulation of the MOO model, which consists of defining the decision variables, the objective functions and constraints; (ii) the solution approach, which hosts the method to be employed to solve the MOO model and find the Pareto optimal set of solutions; and (iii) the optimization algorithm developed to solve the MOO model. The main set of decision variables of the pavement M&R strategy selection problem, which are defined by an integer number is designed to represent all feasible M&R activities to be performed in each pavement section and in each year of the project analysis period (PAP). As far the definition of the objective functions is concerned, the following objectives were inserted by default into the DSS: (1) minimization of the present value (PV) of the total costs incurred by highway agencies with the construction, M&R and end-of-life (EOL) of a road pavement section throughout its life cycle; (2) maximization of the pavement performance over the PAP; (3) the minimization of the PV of the total life cycle road user costs (LCRUC) incurred during both the execution of a M&R activity and the normal

operation of the infrastructure; and (4) the minimization of the life cycle environmental burdens arising from all pavement life cycle phases. To solve the MOO model and find the Pareto optimal set of solutions the augmented weighted Tchebycheff method is adopted in the proposed DSS. To that end, the MOO problem is converted into a SOO one, by combining the several objective functions into a single objective function. However, the optimization model is extremely difficult to solve to an exact optimum given its marked combinatorial nature and the difficulties in verifying, when they exist, the required mathematical properties of continuity, convexity and derivability. Therefore, a Genetic Algorithm (GA) based search heuristic was developed and implemented. Summarily, the GA possesses a hybrid nature in that local search techniques have been incorporated into the traditional GA framework to improve the overall efficiency of the search. Specifically, it contains two dynamic learning mechanisms to adaptively guide and combine the exploration and exploitation search processes.

The integrated pavement LCC-LCA model follows a cradle-to-grave approach and covers six phases: (1) materials extraction and production; (2) construction and M&R; (3) transportation of materials; (4) work zone traffic management; (5) usage; and (6) EOL. These phases were broken down into multiple components which connect to each other by data flows computed through a hybrid life cycle inventory (LCI) approach. Further details on the integrated pavement LCC-LCA model are given in [4], whereas [5] and [6] describe the LCA sub-model and [7] the LCC sub-model.

Once a set of non-dominated solutions is generated representing the optimums for the problem being tackled, the DM faces a multi-criteria decision making problem should he desire to choose a single Pareto optimal solution out of the Pareto optimal set. In order to assist the DM with this task, a decision-support model is implemented in the proposed DSS, where the calculation of distances from the most inferior solution relies on the membership function concept in the fuzzy set theory [8]. The normalized membership function (NMF) provides de fuzzy cardinal priority ranking of each non-dominated solution. The solution with the maximum value of NMF is considered as the best optimal compromise solution (BOCS).

### 3 Case study

#### 3.1 General description

In order to illustrate the capabilities of the proposed DSS, it is applied to a case study consisting of determining the optimal M&R strategy for a one-way flexible pavement section of a typical Interstate highway in Virginia, USA, that yields the best trade-off between the following three, often conflicting, objectives: (1) minimization of the PV of the total life cycle highway agency costs (LCHAC); (2) minimization of the PV of the LCRUC; and (3) minimization of the life cycle environmental impacts (LCEI), which in this case study is limited to one impact category for the sake of brevity. In that sense, the Climate Change (CC) impact category, expressed in terms of CO<sub>2</sub>-eq, was selected because it is increasingly regulated and discussed by both governmental and non-governmental institutions. Furthermore, two scenarios are considered depending on whether or not the most structurally robust M&R activity available for employment throughout the PAP includes recycling-based layers. The features of the case study is shown in Table 1. To ensure practicality of the present model, a set of constraints is defined. Among that set of constraints, the following ones are worthy of mention: (i) the Critical Condition Index (CCI) of a pavement section cannot be lower than 40; and (ii) due to technical limitations which impose limits to the life of the initial pavement design and the most structurally robust M&R activities, the maximum time interval between the application of two consecutive M&R activities of that type is 30 years.

**Table 1** Features of the case study

Parameter	Value
PAP	50 years
Beginning year	2011
Initial AADT	20000 vehicles
Percentage of PCs in the AADT	75%
Percentage of HDVs in the AADT	25%
Traffic growth rate	3%/year
Initial CCI	87
Initial IRI	1.27 m/km
Age	5 year
Number of lanes	4
Lanes length	1 km
Lanes width	3.66 m
Discount rate	2.3%

*PAP – project analysis period; AADT – annual average daily traffic; PCs – passenger cars; HDVs – heavy duty vehicles; CCI – critical condition index; IRI – international roughness index*

### 3.2 Maintenance and rehabilitation activities

The M&R activities considered for application over the PAP are based on [9], and defined as: (1) Do Nothing (DN); (2) Preventative Maintenance (PrM); (3) Corrective Maintenance (CM); (4) Restorative Maintenance (RM); and (5) Reconstruction (RC). In the case of the PrM treatments, two types of treatments are considered: microsurfacing (McrS) and thin hot mix asphalt overlay concrete (TH). As for the RC treatment, two alternatives are also considered. They were named conventional RC and recycling-based RC and differ from each other in that the former comprises exclusively conventional asphalt layers, whereas the latter consists of a combination of conventional asphalt layers with in-place recycling layers. The recycling-based RC activity is designed in such a way that it provides equivalent structural capacity to its non-recycling-based counterpart and takes into account the Virginia Department of Transportation's (VDOT's) surface layer requirements for layers placed over recycling-based layers [10]. Details on the M&R actions comprising each M&R activity are presented in [4].

### 3.3 Pavement performance prediction model

In order to determine the pavement performance over time, the VDOT pavement performance prediction models (PPPM) are used (Eq. (1) and Table 2). VDOT developed a set of PPPM in units of CCI as a function of time and category of the last M&R activity applied [11]. CCI is an aggregated indicator ranging from 0 (complete failure) to 100 (perfect pavement) that represents the worst of either load-related or non-load-related distresses.

$$CCI(t) = CCI_0 - e^{a + b \times c \ln\left(\frac{t}{\tau}\right)} \quad (1)$$

where CCI(t) is the critical condition index in year t since the last M&R activity, i.e. CM, RM or RC; CCI<sub>0</sub> is the critical condition index immediately after treatment; and a, b, and c are load-related PPPM coefficients (Table 2).

Unlike the previous M&R activity categories, VDOT did not develop individual PPPM for PrM treatments. Thus, in this case study the considered PrM treatments, i.e. McrS and TH, are respectively modelled as an 8-point and 15-point improvement in the CCI of the road segment.

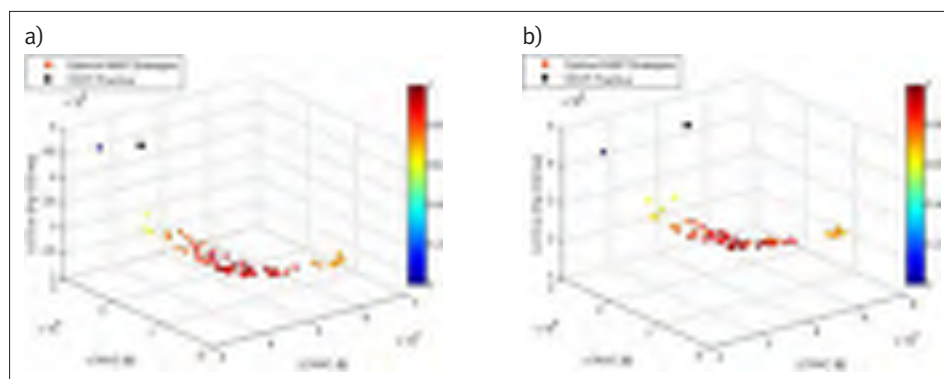
Once the treatment is applied, it is assumed that the pavement deteriorates according to the PPPM of a CM, but without reduction of the effective age. On the other hand, in the case of the application of CM, RM and RC treatments, the CCI is brought to the condition of a brand new pavement (CCI equal to 100) and the age is restored to 0 regardless of the CCI value prior to the M&R activity application.

**Table 2** Coefficients of VDOT's load-related PPPM expressed by Eq. (1) for asphalt pavements of interstate highways

M&R activity category	CCI <sub>0</sub>	a	b	c
CM	100	9.176	9.18	1.27295
RM	100	9.176	9.18	1.25062
RC	100	9.176	9.18	1.22777

### 3.4 Results and discussion

The MOO model was written in MATLAB® programming software [12], and run on a computational platform Intel Core 2 Duo 2.4 GHz processor with 4.00 GB of RAM, on the Windows 7 professional operating system. Figures 1a and 1b display the Pareto optimal set of solutions in the objective space, outlining the optimal pavement M&R strategies for the non-recycling-base and recycling-base scenarios, respectively, along with the M&R strategy defined by VDOT. Table 3 details the features of the BOCSS chosen according to the methodology described in Section 2 as well as the M&R strategy defined by VDOT. The results displayed in Figure 1 show that overall, and for both scenarios, an increase in the LCHAC not only leads to a reduction in the LCRUC but it is also beneficial in reducing the LCCCsc. However, a carefully analysis of this Figure reveals that there exists an investment level after which the Pareto fronts denote a flat trend. That trend means that any increase in pavement M&R expenditures has a greatly reduced reflex in reducing both the LCRUC and LCCCsc.



**Figure 1** M&R strategy defined by VDOT and Pareto optimal fronts: a) scenario I; b) scenario II. Legend: LCHAC – life cycle highway agency costs; LCRUC – life cycle road user costs; LCCCsc – life cycle climate change score. Note: The fuzzy cardinal priority ranking of each non-dominated solution was normalized so that it falls into the range [0;1]



**Table 3** M&R strategies of the BOCSs for both scenarios and current VDOT practice

Scenario	Type of M&R strategy	M&R activity (application year)								Avg CCI	Avg IRI [m/km]
		1 <sup>st</sup>	2 <sup>nd</sup>	3 <sup>rd</sup>	4 <sup>th</sup>	5 <sup>th</sup>	6 <sup>th</sup>	7 <sup>th</sup>	8 <sup>th</sup>		
I and II	Current VDOT practice	CM (7)	RM (17)	RC (27)	CM (39)	RM (49)	–	–	–	83	1.3
I	BOCS	CM (13)	RC (25)	McrS (32)	CM (36)	CM (41)	TH (46)	–	–	77	1.3
II		McrS (2)	CM (4)	TH (12)	CM (18)	RC (24)	CM (30)	TH (36)	CM (41)	81	1.1

Figure 1a, when analysed in conjunction with Figure 1b, shows that the entire Pareto front shifts down and towards the intersection of the LCHAC and LCRUC axis, resulting in significant costs and emissions savings across the pavement life cycle. This change will benefit both the highway agency and road users, with each seeing a decrease in the limits of the range of costs corresponding to the set of non-dominated solutions.

Specifically, the lower and upper bounds of the LCHAC will respectively decrease by 29% and 14%, whereas the road users are expected to experience more modest reductions in the incurred costs, which amount to 2% and 1%, respectively, for the lower and upper boundaries. With regard to the range of greenhouse gas (GHG) emissions, the lower and upper boundaries are likely to be reduced by 8% and 3%, respectively. From the analysis of Figure 1, one can still conclude that the selected optimal M&R strategies (i.e. BOCS) always improve on VDOT practice with regard to the three metrics. Such improvements are obtained by increasing the number of M&R activities applied over the PAP, which translates into a smoother pavement surface over the PAP, thus reducing both the RUC and GHG emissions associated with the most important phase for a high-volume traffic roadway, i.e. the usage phase. The increase in the frequency of M&R activities is particularly notorious in the recycling-base scenario and was only possible without raising the expenditures incurred by the highway agency because the recycling-based RC is cheaper than its non-recycling-based counterpart. Thereby, highway agencies are allowed to get more done with lower consumption of resources.

## 4 Conclusions

This paper presented the development of a DSS framework for pavement management that has the ability to optimize environmental and road user-related objectives, along with the traditional economic objective (i.e. minimization of HAC), by employing a tri-objective optimization procedure to generate a set of potentially optimal pavement M&R strategies for a road pavement section while satisfying multiple constraints. The results of the application of the DSS to a high-volume traffic road flexible pavement section of a typical Interstate highway in Virginia, USA, showed that the best optimal compromise M&R plans have the potential to improve on current VDOT's pavement M&R practice with regard to the three considered metrics. In addition, it was also shown that such improvements can be more expressive if the most structurally robust M&R activity initially considered was replaced by an equivalent recycling-based M&R activity and the best recycling-based optimal compromise M&R strategy was implemented.

## Acknowledgements

João Santos wants to thank the Portuguese Foundation of Science and Technology for the personal research grant SFRH/BD/79982/2011. The authors also want to thank the ACIV for the financial support for the presentation of this research work in the 4<sup>th</sup> International Conference on Road and Rail Infrastructure.

## References

- [1] Santero, N., Horvath, A.: Global Warming Potential of Pavements, *Environmental Research Letters*, 4 (2009) 3, pp. 1-7, doi:10.1088/1748-9326/4/3/034011
- [2] Walls, J., Smith, M.: Life-Cycle Cost Analysis in Pavement Design – in search of better investment decisions, Report No. FHWA-SA-98-079, <http://isddc.dot.gov/OLPFiles/FHWA/013017.pdf>, 1998.
- [3] Santero, N., Masanet, E., Horvath, A.: Life-Cycle Assessment of Pavements. Part I: Critical Review, *Resources, Conservation and Recycling*, 55 (2011) 8-9, pp. 801-809, doi:10.1016/j.resconrec.2011.03.010
- [4] Santos, J., Bryce, J., Flintsch, G., Ferreira, A.: Environmental and Economic Assessment of Pavement Construction and Management Practices for Enhancing Pavement Sustainability, *Resources, Conservation and Recycling*, (2015) (under review).
- [5] Santos, J., Ferreira, A., Flintsch, G.: A Life Cycle Assessment Model for Pavement Management: Methodology and Computational Framework, *International Journal of Pavement Engineering*, 16 (2015) 3, pp. 268-286, doi:10.1080/10298436.2014.942861
- [6] Santos, J., Bryce, J., Flintsch, G., Ferreira, A., Diefenderfer, B.: A Life Cycle Assessment of In-Place Recycling and Conventional Pavement Construction and Maintenance Practices, *Structure and Infrastructure Engineering: Maintenance, Management, Life-Cycle Design and Performance*, 11 (2015) 9, pp. 119-1217, doi:10.1080/15732479.2014.945095
- [7] Santos, J., Bryce, J., Flintsch, G., Ferreira, A.: A Comprehensive Life Cycle Costs Analysis of In-Place Recycling and Conventional Pavement Construction and Maintenance Practices, *International Journal of Pavement Engineering*, (2015) (available online).
- [8] Zimmormann, H.: *Fuzzy Set Theory and Its Application*, Third edition, Norwell: Kluwer Academic Publishers, 1996.
- [9] Chowdhury, T.: Supporting Document for the Development and Enhancement of the Pavement Maintenance Decision Matrices Used in the Needs-Based Analysis. Virginia Department of Transportation, Maintenance Division, Richmond, VA, 2011.
- [10] Virginia Department of Transportation (VDOT), Project selection guidelines for cold pavement recycling. Virginia Department of Transportation Materials Division. [http://www.virginiadot.org/VDOT/Business/asset\\_upload\\_file526\\_3638.docx](http://www.virginiadot.org/VDOT/Business/asset_upload_file526_3638.docx), 2013.
- [11] Stantec Consulting Services and Lochner, H.: Development of Performance Prediction Models for Virginia Department of Transportation Pavement Management System, Virginia Department of Transportation, Richmond, VA, 2007.
- [12] MATLAB: MATLAB Primer, Version 8.5. The MathWorks Inc., Natick, MA, 2015.





## ENERGY HARVESTING ON TRANSPORT INFRASTRUCTURES: THE SPECIFIC CASE OF RAILWAYS

Francisco Duarte<sup>1</sup>, Adelino Ferreira<sup>1</sup>, Cássio Paiva<sup>2</sup>

<sup>1</sup> University of Coimbra, Department of Civil Engineering, CITTA, Portugal

<sup>2</sup> Department of Civil Engineering, UNICAMP, Brazil

### Abstract

With the growing need for alternative energy sources, research into energy harvesting technologies has increased considerably in recent years. The particular case of energy harvesting on railways is a very recent area of research. Railways are continuously exposed to train loads, making it possible to extract energy from them which, using specific technologies, can be transformed into electrical energy. This paper deals with the development of energy harvesting technologies for railways, identifies the technologies that are being studied and developed, examines how such technologies can be divided into different classes and gives a technical analysis and comparison of those technologies, using the results achieved with prototypes.

*Keywords: Energy harvesting, renewable energy, energy conversion, railways*

### 1 Introduction

With the present energy paradigm, most electrical energy production uses fossil fuels as its energy source, leading to irreversible environmental damage, as well as making economies dependent on fuel costs. According to the International Energy Agency [1], in 2011, globally, more than 80% of energy production came from fossil fuels. In terms of renewable energy, hydro power plants represent the most significant energy source.

Urgent action is required to change the paradigm of electric energy generation. Presently, energy is mostly produced in large power plants, consuming non-renewable resources and inducing energy losses between the point of production and the point of final consumption. Energy production must be based on renewable resources, decentralized, produced near to the point of consumption and, preferably, when it is needed.

In the area of renewable energies, besides the major energy sources (hydro, solar, wind, waves), energy harvesting has recently been considered on a micro scale, where it is possible to generate electricity from small energy variations, such as thermal gradients, pressure, vibrations, radiofrequency or electromagnetic radiation, among others [2].

Railways are continuously exposed to train loads, making it possible to extract energy from them which, using specific technologies, can be transformed into electrical energy. This is a very recent research area, denominated railway energy harvesting.

Besides other alternative energy generation methods which do not consume the planet's resources, this is also practical in terms of energy efficiency, as it can work as a solution to generate electrical energy where and when it is needed, avoiding expensive electrification of specific sites, distribution inefficiencies, and storage costs.

The present research work aims to study energy harvesting technologies with possible implementation on railways, using the energy released by trains as an energy source.

## 2 Railway energy harvesting technologies

Energy Harvesting is described as a concept by which energy is captured, converted, stored, and utilized using various sources, by employing interfaces, storage devices, and other units [2, 3]. Put simply, energy harvesting is the conversion of ambient energy present in the environment into electrical energy [4].

Energy harvesting is divided in two main groups: macro energy harvesting and micro energy harvesting. Macro energy harvesting sources are associated with solar, wind, hydro and ocean energy, while micro energy harvesting sources are associated with electromagnetic, electrostatic, heat, thermal variations, mechanical vibrations, acoustics and human body motion [2, 5]. The main difference between these two groups is the scale. Macro energy harvesting sources are related to the harvest of great amounts of energy in a single unit, while micro energy harvesting is concerned with smaller power generation units, typically dimensioned to supply specific electric and electronic applications [4].

The discontinuous nature of energy harvesting sources has consequences in the way the electric devices powered by energy harvesting are operated. Two situations are common [6]: the power consumption of the device is lower than the average harvested power, which allows the device to be operated continuously; or the power consumption of the device is higher than the average harvested power, meaning there is discontinuous operation, with the time between operations being dependent on the stored energy of the device.

In the case of railways, the concept of energy harvesting started with the goal of directly supplying the trackside electrical infrastructures for safety and monitoring purposes. These consist of electric and electronic equipment such as sensors, cameras, electric panels, among others. These devices typically have a power consumption of 10-100 W [7], so this was set as the energy generation goal for several research projects [7, 8, 9].

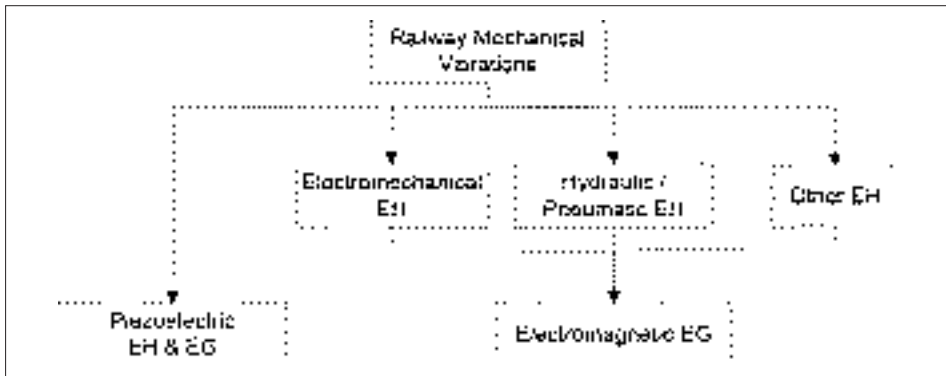


Figure 1 Railway energy harvesting and generation technologies

Different systems were developed for this purpose, both for harvesting the mechanical vibrations induced by trains into the railways, as well as converting these into electricity. Energy conversion (or energy generation) technologies are mostly electromagnetic and piezoelectric but, in the case of electromagnetic technology, the systems to actuate the energy generation components can be electromechanical, hydraulic, pneumatic, or other specific systems. The electromagnetic generators can be linear or rotational. Figure 1 presents the segmentation of the developed systems, with EH representing Energy Harvesting and EG representing Energy Generation.

### 3 Technical analysis

#### 3.1 Definitions

To perform a technical analysis and evaluate an energy generation technology, the most commonly used parameters are the conversion efficiency and the energy generation of the technology under its normal operation (Table 1). As these are mostly new technologies, it is important to classify them according to their development status. Also, as the installation method can vary between different systems, this is an important issue regarding the final cost of the solution as well as the maintenance operations of the equipment. Therefore the technologies should also be classified according to their installation method.

**Table 1** Parameters for performing a technical analysis

Parameter	Description
Conversion Efficiency	Energy conversion efficiency ( $\eta$ ) is the ratio between the useful output of an energy conversion device and the energy input. In the case of electrical machines, the output is electrical energy measured in Joules (J), or electrical power measured in watts (W). The energy conversion efficiency is a dimensionless parameter, usually expressed as a percentage.
Energy Generation	Energy generation is used to quantify the amount of electrical energy generated under the operating conditions. It gives the energy input of the system, its efficiency, and the installed power. Usually it is expressed in Joules, but in some micro energy harvesting devices, it can also be related to the volume ( $J/m^3$ ). In the analysis of energy harvesting devices, sometimes power generation is also presented, related to the volume of the device ( $W/m^3$ ).
Installation Method (IM)	The different energy harvesting devices can be installed on the railways using different techniques, and in different zones of the railway. Four main installation methods were identified.
Technology readiness level (TRL)	Technology readiness levels (TRLs) are measures used to evaluate the maturity of a technology during its developmental stages. These levels were initially defined by NASA [10], but are now commonly used in project evaluations.

#### 3.2 Comparison of technologies

Following the analysis of the different technologies presented in this paper, the main characteristics of each one are presented in Table 2. For this analysis, only technologies with results published in scientific papers were considered. From Table 2, it may be seen that most of the studies does not quantify the conversion efficiency of the technologies, but almost all reveal the power/energy generation, the installation method and identify the TRL. From this analysis, one can conclude that most current research is based on electromechanical systems, and these are the ones that permit higher values in terms of electrical energy production. The system developed by Lin et al. [7], which results from an optimization of two previous studies [11, 12], presents the highest value in terms of energy generation, proved experimentally, and is the more advanced in terms of technology readiness level. Piezoelectric technology, besides being on an advanced TRL, presents very low energy production values, making it a technology with low economic viability for generating electrical energy. Hydraulic systems, especially the system developed by Pourghodrat [8], present an interesting potential, as with one unit a good value was achieved in terms of energy production (the second highest, proved experimentally), which can be multiplied with the use of more hydraulic units connected to the same electromagnetic generator.

**Table 2** Technical analysis of different railway energy harvesting technologies

Technology	Ref.	Conversion Efficiency	Power/ Energy Generation	Installation Method (IM) <sup>1</sup>	TRL <sup>2</sup>
Piezoelectric	[17]	N.A.	0.05 mW	1	5
	[16]	N.A.	N.A.	2	3
	[18]	N.A.	0.26 mJ	2	5
Hydraulic	[19]	N.A.	N.A.	3	2
	[8]	N.A.	11.08 W	1	4
Electro-mechanical	[11]	N.A.	10.05 W	1	4
	[12]	22.0%	2.50 W	1	4
	[8]	N.A.	4.24 W	1	4
	[8]	N.A.	50.00 W (T)	3	2
	[9]	N.A.	5.29 W	1	4
Other	[7]	45.6%	49.8 W	1	5
	[17]	N.A.	0.15 W	1	3
	[13, 14]	N.A.	N.A.	3	N.A.

1 – IM 1 – Fixed on the railway lateral area, harvesting the railway vibrations;

IM 2 – On the railway basis, between the railway and the sleeper;

IM 3 – On the railway track, harvesting the train's wheel mechanical pressure.

2 – TRL 1 – Basic principles observed and reported;

TRL 2 – Technology concept and/or application formulated;

TRL 3 – Analytical and experimental critical function and/or characteristic proof-of-concept;

TRL 4 – Component validation in laboratory environment;

TRL 5 – Component validation in relevant environment;

TRL 6 – System/subsystem model or prototype demonstration in a relevant environment;

TRL 7 – System prototype demonstration in an operational environment;

TRL 8 – Actual system completed and qualified through tests and demonstration;

TRL 9 – Actual system proven in operational environment.

In terms of installation, most of these technologies are fixed on the railway lateral area, harvesting the mechanical vibrations of the railway. The exceptions are the piezoelectric systems, installed between the railway and the sleepers, and some other systems that use the train's wheels pressure to be actuated, harvesting the mechanical energy directly from the train's weight.

In terms of TRL, the Mian's system [13, 14] is already available on the market by the International Electronic Machines Corporation [15], but no values regarding energy production or conversion efficiency were published. Besides this system/product, Innowattech [16] also presents some piezoelectric solutions in their portfolio, without presenting energy generation or energy conversion efficiency of the systems. Apart from these two systems, which are related to their company's R&D, the electromechanical system presented by Lin et al. [7] is the one which is at the most advanced stage, as it has been tested and validated in real environment. Most of the other solutions analysed were only tested in laboratory.

## 4 Conclusions

The concept of railway energy harvesting is a very recent area of research, which has only taken off in the last five years. Unlike wind energy, the present situation shows a wide variety of energy harvesting systems at several stages of development, competing against each other to get an opportunity in the market. Different technologies are being investigated in order to convert mechanical energy induced by trains onto the railways into electrical energy. Piezoelectric and electromagnetic technologies are dominant, with electromagnetic generators being actuated by different harvesting systems.

In terms of systems/technologies validated in real environment, with published results, only one system is available. This system was developed by Lin et al. [7] and achieved a power production of 49.80 W for each train passage. Multiplying the number of devices, higher values of energy production can be achieved for each train passage. However, the investment in the solution would be multiplied by the number of devices. In that sense, the hydraulic system proposed by Pourghodrat [8] could be a very interesting solution, as with one hydraulic energy harvester and one electromagnetic generator, a power production of 11.08 W was achieved in laboratory for a train passage; as this system allows us to multiply the hydraulic harvesters for the same electromagnetic generator, the harvested energy (and consequently, the electrical energy produced) can be multiplied without the need to multiply the number of generators. So, with a lower investment increase compared with the electromechanical system proposed by Lin et al. [7], the energy production can be greatly increased.

In terms of application, most researchers have targeted electric and electronic devices used to monitor the railway tracks and to guarantee the user's safety, with power consumptions of 10.00 to 100.00 W [20]. To supply these electric and electronic devices, the two systems mentioned previously could be interesting solutions. These are the most targeted solutions mainly due to the fact that on railway lines there are many areas with no electricity, which makes it a challenge to supply electric devices in those areas.

However, multiplying the number of energy harvesters and generators, higher values of energy production can be achieved, and the concept of railway energy harvesting can increase its potential by injecting the produced energy into the electrical national grid. This is also based on the considerable available power in a railway track if long distances are considered, allowing the extraction and generation of a great amount of energy. These two major applications should be considered when the technical and economic viability of the developed technologies are studied, considering the cost of each solution to analyse the return on the investment.

## Acknowledgements

The present research work has been carried out in the framework of project PAVENERGY – Pavement Energy Harvest Solutions (PTDC/ECM-TRA/3423/2014). The author Francisco Duarte is also grateful to the Portuguese Foundation of Science and Technology for the financial support provided to this study through Grant SFRH/BD/95018/2013.

## References

- [1] IEA: Key World Energy Statistics 2013, International Energy Agency, Paris, France, 2013. Available from <http://www.iea.org/publications/freepublications/publication/KeyWorld2013.pdf>
- [2] Khaligh, A., Onar, O.: Energy harvesting: solar, wind, and ocean energy conversion systems, CRC Press Inc., 2010.
- [3] Priya, S., Inman, D.: Energy harvesting technologies, New York, Springer, 2009.
- [4] Kazmierski, T., Beeby, S.: Energy harvesting Systems – Principles, Modelling and Applications, New York, Springer, 2009.
- [5] Yildiz, F.: Potential ambient energy-harvesting sources and techniques, The Journal of Technology Studies, Issue 35, pp. 40-48, 2009.
- [6] Harb, A.: Energy Harvesting: State-of-the-art, Renewable Energy, Issue 36, pp. 2641-2654, 2011.
- [7] Lin, T., Wang, J., Zuo, L.: Energy Harvesting from Rail Track for Transportation Safety and Monitoring, 2014.
- [8] Pourghodrat, A.: Energy harvesting systems design for railroad safety, 2011.
- [9] Phillips, K.: Simulation and control system of a railroad track power harvesting device, 2011.



- [10] Mankins, J.: Technology readiness levels, White Paper, 1995.
- [11] Nelson, C., Platt, S., Hansen, S., Fateh, M.: Power harvesting for railroad track safety enhancement using vertical track displacement, In SPIE Smart Structures and Materials+ Nondestructive Evaluation and Health Monitoring, International Society for Optics and Photonics, pp. 728811-728811, 2009.
- [12] Penamalli, G.: Structural health monitoring and energy harvesting for railroad, PhD dissertation, The Graduate School, Stony Brook University, Stony Brook, NY, 2011.
- [13] Mian, Z.: Wireless Railroad Monitoring, US Patent No. US 8423240 B2, United States Patent and Trademark Office (USPTO), USA, 2013a.
- [14] Mian, Z.: Energy Harvesting, US Patent No. US 20130221680 A1, United States Patent and Trademark Office (USPTO), USA, 2013b.
- [15] IEM: International Electronic Machines Corporation. <http://www.iem.net/>. Accessed in June 8, 2015.
- [16] Innovattech: <http://www.innowattech.co.il/>. Accessed in December 15, 2015.
- [17] Nelson, C., Platt, S., Farritor, S., Albrecht, D., Kamarajugadda, V.: Regenerative Power for Track-Health Monitoring, Reported to Federal Railroad Administration, 2007.
- [18] Wischke, M., Masur, M., Kröner, M., Woias, P.: Vibration harvesting in traffic tunnels to power wireless sensor nodes, *Smart Materials and Structures*, 20 (8), 2011.
- [19] Oxtoby, D.: Road or rail track energy generator, UK Patent Application No. GB 2469294 A, Intellectual Property Office, UK, 2010.
- [20] Zuo, L., Tang, X.: Large-scale vibration energy harvesting, *Journal of intelligent material systems and structures*, 24 (11), pp. 1405-1430, 2013.



## EXPLOITATION OF NEW TECHNOLOGIES FOR COLLECTION AND PROCESSING OF MOTORWAY TRAFFIC DATA

Antoniadis Christos, Sotiriadou Styliani, Papaioannou P.

*Aristotle University of Thessaloniki, School of Civil Engineering, Greece*

### Abstract

The transportation section is of paramount importance for a society and for that reason is directly connected to growth from every aspect. The implementation of new technologies in transportation systems, known as Intelligent Transport Systems (ITS), came into reality during the last decades, functioning effectively in combination with the new high standard motorways and are expected to grow considerably in the following years. The planning, design and implementation of such systems is an interesting field for researchers involved in transport infrastructure projects and equipment. Through this study, which deals with the issue of new technologies in the area of collection and processing traffic data, an attempt to analyze comprehensively the traffic measurement data at all stages is made, with emphasis on new and technologically advanced means of ITS. These systems comprise a combination of information and communication technologies applied to the transport sector in order to secure efficient and economical movement of people and goods using new technologies. The aim of the present paper is, therefore, the in-depth investigation of these systems, the presentation of all their aspects, such as the advantages of their use, their area of application and especially their prospects of development and wider use, particularly in Greece.

*Keywords: Intelligent Transportation Systems, Traffic Data, Traffic Data Measurement*

### 1 Introduction

During the last decades, the population and the economy of Europe have undergone great development, which resulted the expansion of transport networks, the mobility and the economic activities increase as well as significant productivity benefits. Considering that mobility is a prerequisite for progress, social and economic prosperity and definitely a basic social need, the challenge of effective and efficient transport has become a great necessity for the economies of the European countries and for the society as a whole, especially at the actual economically unstable environment. The increasing demand of people and goods mobility should be satisfied and managed by measures aiming at optimizing the use of existing infrastructure. New technologies and innovations, whether they concern the infrastructure design or the management, either the fleet technology (vehicles, trains, airplanes etc.), are the key element for the development and the regular function of transport system. Due to the great increase of the traffic volume occurring in recent years in each and every road network worldwide, the importance lies in the new requirements in the field of operative roadwork management. However, the implementation of such management initially requires the acquisition of relevant traffic data through the road infrastructure itself. These conditions have led to the development of yet another road equipment field, the traffic monitoring equipment. So far, this field includes only the sensors considering traffic lights, as well as closed circuit television cameras in dangerous places such as tunnels or bridges. Modern monitoring utilizes

both existing and new technologies for its purpose, which is the measurement of every kind of traffic data (speed, volume, density etc.) and the traffic monitoring.

## 2 Systems and equipment for measuring and recording traffic parameters

The main traffic parameters on a road network are:

- The traffic volume  $Q$  (vehicles per hour) and traffic composition-classification;
- The speed of vehicles  $V_t$ ,  $V_s$  (km per hour);
- The traffic density  $K$  (vehicles per hour) or average spatial or temporal separation of vehicles;
- The number and the type of accidents;
- The parameters regarding parking.

The awareness of the current state of a road network, namely the traffic conditions and habits that prevail during the study period, allows the prediction of future traffic demand and simultaneous investigation of a variety of options for its support. Moreover, almost every day, many elements about the different traffic and mobility characteristics required, in order to address the traffic and take immediate measures to improve traffic conditions [1].

### 2.1 Traffic speed measurement methods

The main methods of traffic speed measurement in one specific point are [2]:

- Measurement with speedometer-radar: This instrument uses the principle of the radar operation and when it is directed to a vehicle, it automatically shows to a suitable counter its speed in miles or kilometers per hour;
- Measurement with electronic speedometer: Two probes-detectors, either elastic with pneumatic tube or magnetic, are placed at a distance about 2 km the one from the other on a road pavement. The instrument records the time required for a vehicle to arrive from the first detector to the second and through that time it calculates the speed;
- Measurement with observer: In this method, one or two observers measure the time required for a vehicle in order to cover a given distance.

### 2.2 Traffic volume measurement methods

The traffic volume measurements are divided into those made by observers and those made by automatic devices. Therefore, the categories of traffic volume measurements are (Table 1): [3]

- Observer methods;
- Photographic methods;
- Automatic counting methods;

The most common automatic measurement method is the pneumatic road tube sensor, especially for short-term measurements, such as 24-hour or 48-hour traffic volumes. Other automatic counters are:

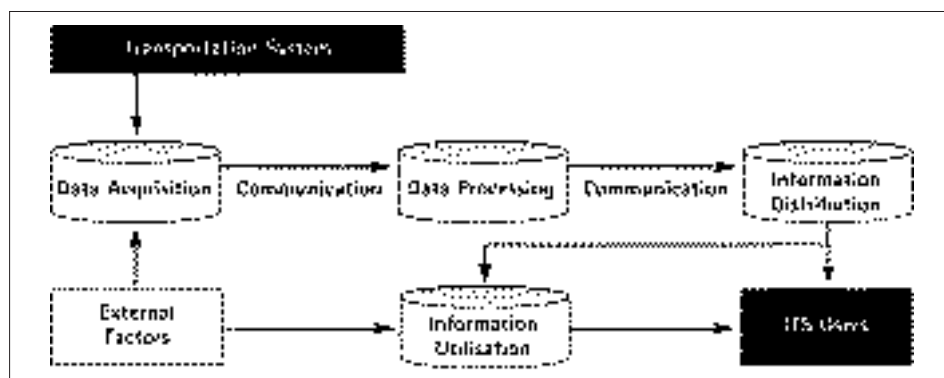
- Magnetic detectors;
- Detection sectors outside the roadway;
- Closed circuit television (CCT);
- Digital image processing.

**Table 1** Summary comparative presentation of the traffic volume measurement methods [4]

Method	Advantages	Disadvantages
Observers	More detailed (Classification, turning movement); The number of the observers can be adjusted to traffic volume; Low cost for short duration	High cost for long duration; Difficulty in long duration 24/7 is impossible; In high volume points many observers required; Weather problems
Photographic	Measurements made in the office; Repetition of every photo take; Acquisition of more data	Devices cost; Long duration of analysis; Finding suitable and accessible installation site
Automatic counting	Low cost for long duration; Ability of unlimited duration, consecutive function 24/7; Function during bad weather and environmental conditions	Difficulty in classification; High cost for short duration; Difficulty in turns recording; Possibility of destruction; Every section requires a device

### 3 Intelligent Transportation Systems (ITS)

ITS contain many combined technologies, such as the use of video camera, views of information messages, digital wireless broadcasting, closed-circuit monitoring and other specialized communication devices in order to record the traffic volume, to decode the passenger information in real time and to warn in case of emergency, Figure 1. Today, transport application that utilize such intelligent systems are broader and more complex, including traffic management systems, route control, information for the passenger or the operator which contributes to the optimization of the flow by allowing the diversion to alternative routes with space availability. [5]



**Figure 1** ITS data chain [6]

#### 3.1 ITS Applications

##### 3.1.1 Traffic data collectors

Many different instruments and tools are available in order to be used for the traffic data collection and recording. These data could be used for many different purposes and be exploited in many ways, Table 2. The most common traffic data collectors are: [7]

- Loop detectors;
- Microwave detectors;
- Ultrasound detectors;

- Active infrared detectors;
- Passive infrared detectors;
- Laysers detectors;
- CCT (Closed circuit television);
- Digital image proccessing;
- Radar;
- Transponder data collection (Probe Data);
- Response cards in car interior;
- Global Positioning System (GPS);
- Cellular phones.

**Table 2** Modern traffic data collection methods [8]

Data collection method	Traffic flow	Traffic jam	Car Category	Velocity	Travel time	Accident detection
Loop Detector	Yes	Yes	If speed is availbale	With 2 consecutive loops	No	Yes
Pneumatic tube	Yes	Indirectly	Partly	With 2 probes – not concise	No	No
Camera	Yes	Yes	Yes	Yes	No	Under conditions
Radar	Yes	Yes	Yes	Yes	No	Yes
Infrared detectors	Yes	Yes	No	No	No	No
Floating Car Data (FCD)	No	No	Yes	Yes	Yes	Yes

### 3.1.2 Traffic management centers

After the collection of traffic data, their processing is the key element of all ITS. Those data, in order to be useful, must be able to be converted in information and this is possible only if they are in forms and times suitable to be used in a particular decision, Figure 2. Therefore, information should be provided to the decision makers at the appropriate time and in perceptible forms. Hence, there are centers where information is collected. Then, an appropriate processing is made, and this information is sent through suitable systems to the recipients each time [9].



**Figure 2** Function of user information system [10]

## 4 Conclusions

ITS applications are very effective and advantageous with multiple benefits for both society and economy. Therefore, it is necessary to become a high priority, especially regarding the use of available resources. The use of ITS is beneficial for the passengers that travel, the businesses, the government agencies, the transport systems administrators and finally the society and the environment. The strategic objectives set out under the policy of Intelligent Transport Systems (ITS), namely the road safety, the sustainable mobility with the components of energy saving and environmental protection, the resource conservation, the development of the economy and the social cohesion, become achievable with the development and the spreading of ITS. Consequently, the evaluation of ITS through various assessment techniques is really useful and almost necessary for the improvement of traffic conditions.

## References

- [1] Giannis, G., Gkolias, I., Kannelaidis, G.C.: Concepts of Basic Traffic Parameters.
- [2] Frantzeskakis, I., Giannopoulos, J.: Design of Transport and Traffic Engineering. Thessaloniki: Epikentro, 1986.
- [3] Mathew, T.: Chapter 8 – Automated Traffic Measurement, 2014.
- [4] Gkortsilas, E., Emmanouilidis, S., Kanakaris, G.: Traffic Study Nodes. Thesis. Department of Civil Engineering Infrastructure. Technological Institute, Thessaloniki, 2009.
- [5] Daiheng, N.: Chapter 1 – Traffic Sensing Technologies, 2014.
- [6] Kyriazis, T.: Intelligent Transport Systems. Thesis. Department of Informatics and Telematics, Harokopion University, Athens, 2013.
- [7] Tsanaktsidis, G., Tsitsoulas, n.d.: Traffic monitoring systems.
- [8] Leduc, G.: Road Traffic Data: Collection Methods and Applications, 2008.
- [9] Yokota, T., Weiland, R.: ITS System Architectures for Developing Countries, 2004.
- [10] Stamos, I., Grau, J., Mitsakis, E., Ayfadopoulou, G.: Large scale dynamic traffic assignment model for Real-Time Traveler Information Services.





## EFFICIENT RAILWAY INTERIORS – EXPERIENCES BAGGAGELESS – BAGGAGE LOGISTIC SYSTEM

Bernhard Rüger<sup>1</sup>, Petra Matzenberger<sup>2</sup>, Volker Benz<sup>2</sup>

<sup>1</sup> Vienna University of Technology & St. Pölten Univ. of Applied Sciences, Austria

<sup>2</sup> Vienna University of Technology, Austria

### Abstract

Luggage is one of the main reasons why people choose their car instead of public transportation. In order to support more sustainable and active forms of mobility, it is necessary to develop ground-breaking logistic systems not only for travellers themselves but also for their luggage. Due to the complexity of efficient and customer-oriented independent “public luggage transport” and as a first step, an exploratory project “GepäckLoS” (founded by the Austrian Ministry for Transport, Innovation and Technology and the the Austrian Research Promotion Agency) considering all reasonable, possible and thinkable options was launched. In order to minimise the development risks it was first necessary to survey and define all requirements. Therefore, extensive customer surveys were conducted. With the data assembled there is now a secondary project with the purpose of developing a goal-oriented and efficient system.

### 1 Introduction

For future-oriented, attractive and also economically realisable service features concerning the transport of luggage and goods independently from passenger traffic, it is essential to know the needs and demands of potential users. Moreover, it is necessary to define scenarios in the context of which there is a need for the transport of luggage.

The purpose of this paper is the inquiry into, and the analysis and interpretation of the needs and demands of different potential users. First of all, the relevant scenarios, groups and with them the connected chains of transportation were defined. Basically, there are two groups of users in the project “GepäckLoS”, travellers and people on their daily travel routes.

The group of “travellers” is made up of people who are on a journey with luggage to a certain target destination. All opportunities for transportation are included. But you have to be careful as journeys with public transport are multimodal by definition. As a result, luggage handling is also more time-consuming. Multimodal transport will substantially profit from a system such as “GepäckLoS”. The “daily travel routes” include for example, different shopping tasks (shopping for food, electronic equipment, etc.) or travel in the context of which a person must carry a certain piece of luggage over a longer period of time. This could be a sports bag for example, which the person has to take to the office because he or she needs it to go to the fitness centre in the evening. Daily travel routes describe a very heterogeneous group of routes, on which one or more pieces of luggage have to be taken from or to a residence. The system developed in the project “GepäckLoS” is going to make the transport of these pieces of luggage substantially easier. Moreover, in many cases it will make it possible to use environmentally sustainable means of transportation such as public transportation or a bicycle.





Figure 1 Example of a (multimodal) chain of transportation with luggage



Figure 2 Example of a (multimodal) chain of transportation with luggage of daily life

The demands and specifications of these two groups are estimated very differently. For this reason the survey tried to go into the demands and specifications to find a fitting solution. Five different questionnaires were developed for data collection to get a good overview of all the different groups of potential users. The questionnaires include demographic information, questions about actual or general habits and situations concerning shopping or travelling. The five different questionnaires were used to question potential users:

- on their journey in trains,
- in shopping malls or shopping streets,
- during their stay in rehabilitation centres,
- online about shopping and
- online about travelling.

With the help of the results of the surveys, it was possible to get detailed information about the special interests the survey groups have in a luggage logistic system as well as their needs and demands. Additionally, qualitative surveys were done with business proprietors to determine their interest in and demands for a luggage logistic system. They also showed an interest in the service, especially to oppose the online trade. The results of the surveys provide a basis for the design of the whole system and for the evaluation of the new system and currently operating systems. This paper only includes the results of the survey concerning luggage transport.

## 2 Interest in baggage services

Altogether, 8,800 passengers were questioned in long-distance trains in Austria, Germany and Switzerland. Most of them (78%) were between 18 and 59 years of age. The age group between 18 and 26 made up with 26% of all passengers the largest group. The gender relationship was balanced; 51% were female and 49% male. One fourth of all passengers stated as the purpose of their journey, travel to or from work, school or other training programmes. Other travel purposes were longer holidays (18%), short getaways (17%), private issues (16%), business trips for one or more days (12%) and day trips (10%). The passengers are rarely weekly commuters or on a shopping trip. Ninety-eight percent of all passengers had some baggage with them. Handbags and shopping bags also counted as baggage. Large pieces of luggage such as medium and large suitcases as well as travel bags and backpacks were carried by 37% of all passengers. One third of them felt hindered by their luggage. Most difficulties occurred upon boarding the train, finding a seat and stowing their luggage.

In addition to direct questioning in the trains, there was also an online questionnaire. Patients of the rehabilitation centres in Weyer, Saalfelden, Bad Schallerbach and Bad Hofgastein also participated in the survey. The reason for the survey in the rehabilitation centres was that there is a similar service in Germany, which is often used by patients of such centres.

By direct questioning in trains in Austria, Germany and Switzerland 12% of the participants said that they would use the service “GepäckLoS” during their current journey. Ten percent of them said that they would likely use the service. In addition, persons who answered “likely no” or “no” were asked if they would use the service in general, for example during another journey. Twenty percent answered this question with yes and 27% with likely yes. Twenty-five percent of the respondents of rehabilitation centres, who usually have a lot of luggage because of their long stay, said that they would have used the service for their current stay. Twelve percent said that they would have likely used it. All patients were also asked if they would use the service for general journeys or other rehabilitation stays. Thirty-one percent answered that they would generally use it and 21% would generally likely use it. In the online questionnaire people were only asked if they were interested in using the service in general. “Yes” was the answer of 37% and “likely yes” of 40%. Through specific analysis of the direct surveys in the train, the parameters influencing the use were determined. Following is a ranking of the top influencing factors concerning the use during the current journey:

### • Hindrance because of the luggage

The service would be used by:

- 56% of the passengers who feel hindered at the train station because of their luggage,
- 53% of the passengers having problems boarding the train,
- 49% of the passengers having hindrances during their journey to the train station,
- 42% of the passengers having problems directly in the train.

### • Travellers with babies and infants (between 1 and 6 years)

The service would be used by:

- 50% of the travellers with a pram
- 47% of the travellers with babies
- 44% of the travellers with infants between one and six years of age.

• **The larger the pieces of luggage**, the more likely the service would be used. Forty-nine percent of all passengers with three large pieces of luggage would use the service.

• **Forty-eight percent of passengers** with physical disabilities, which may cause them to have problems with luggage transport, would use the service during the current journey.

• **Forty-three percent of passengers** who arrived by taxi at the train station would use the service.

### 3 Willingness to pay

The willingness to pay for the service asked of passengers in the train can be seen in the next chart (Figure 3).

- Travellers with babies and infants (between 1 and 6 years)  
More than 10 Euros would be paid for the service by:
  - 57% of the travellers with babies,
  - 46% of the travellers with a pram,
  - 45% of the travellers with infants.
- Forty-eight percent of the passengers taking a bicycle with them would pay more than 10 Euros for the service.
- The willingness to pay increases with the number of large pieces of luggage. Forty-seven percent of the passengers with at least three large pieces of luggage would pay over 10 Euros for the Service.
- Passengers who arrived by taxi or motorcycle had a higher willingness to pay. Forty-three percent of the passengers arriving by taxi and 43% of the passengers arriving by motorcycle would pay more than 10 Euros. But 40% of the passengers arriving by motorcycle thought that the service should be included in the ticket price.
- Passengers who were travelling first class had a higher willingness to pay. Forty-two percent would pay more than 10 Euros.

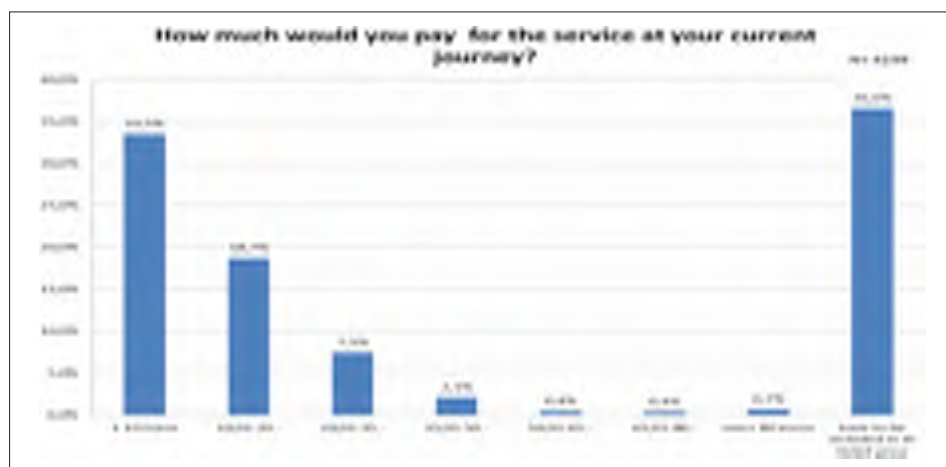


Figure 3 Representation of the willingness to pay by train passengers

### 4 Reasons for not using the system

It didn't matter whether they would use the system or not, but older passengers had more apprehensions concerning the luggage logistic system. They had for example, fear of a high price, luggage arriving late or not at all and theft or damage. Passengers with physical disabilities, which may cause them problems with luggage transport, had fewer fears than the overall average.

## 5 Discussion and conclusion

In principle, these surveys showed that the points “shopping” and “travelling” couldn’t be considered as one system. There must be a separation between “shopping” and “travelling” to find and develop the best system for each.

On the whole, regardless of pieces of luggage, age and other points, 22% would have used the described system for their luggage during their current journey. If people felt uncomfortable because of their luggage, they would definitely use the service more often. Fifty-six percent of the passengers who felt hindered at the train station would use the service. Accordingly, the question was, which passengers felt hindered at the train station because of their baggage. The hindrance at the train station was independent of age, gender, nation, travel class, physical disability and baggage. What mattered was if the passengers were travelling with a baby, an infant or also a 7 to 14 year old child.

However, what is dependent on gender and to some extent on age were the problems in boarding the train. Fifty-three percent of passengers with problems in boarding would use the service. Women (15%) had more problems boarding the train with their luggage than men. Also, older passengers showed a few more difficulties concerning boarding the train. Thirteen percent of the passengers between the ages of 60 and 74 had problems boarding the train. Forty-two percent of the passengers who had hindrances directly in the train would use the service. There were many differences between certain groups. For example, there were country- and travel-class-specific differences. Austrians had fewer problems stowing their luggage in comparison with the Swiss (14%) and Germans (25%). Passengers who were travelling first class had fewer problems stowing their luggage than passengers travelling second class.

Passengers who arrived by taxi were often travelling with large pieces of luggage. At this point environmentally-minded thoughts should be introduced. If travellers could check in their luggage at the residence door or a check-in terminal, they would not have to take a taxi but could instead use public transport.

According to the direct survey, other groups, which would like to use the service, were travellers with a baby (47%), an infant (44%) or a pram (50%).

Although the difference wasn’t that clear (29%), people travelling with another adult or teenager would likely use the service. Especially interesting were the country-specific differences. Passengers who were asked in Switzerland would use the service least (16%). Twenty-three percent of people asked in Austria and 28% of those asked in Germany would use the service. In addition to the questions about their interest in using the service, passengers were also asked about their willingness to pay. An economically realistic price wouldn’t be under ten Euros. Due to this which groups had a higher willingness to pay and which factors had an influence on this was more closely examined.

The group which had the highest willingness to pay were travellers with a baby (57%) or an infant between the ages of one and six (45%). Also the elderly would pay a higher price. Thirty-eight percent of passengers between the ages of 75 and 84 would pay more than ten Euros. With 38% they placed only sixth in willingness to pay. More influencing factors on willingness to pay can be found in 2.3. There are three, possibly four, main user groups deriving from interest and the willingness to pay:

- Travellers with a baby or an infant between the ages of one and six,
- Elderly travellers (at least 60 years old),
- Travellers with large pieces of luggage.
- People with physical disabilities would surely be an interesting target group. However, their willingness to pay was relatively low. More consideration would be necessary concerning funding a developed system for this group.

According to the results of this survey, the following table shows the needs and demands of the main user groups. In the first column are the results for the general public. The differences of the main user groups are described in the subsequent columns.

**Table 1** Needs and demands of potential users in general and particularly for certain user groups

	The general public	Travellers with a baby	Elderly travellers	Travellers with large pieces of luggage
Earliest pickup of the luggage	under 1h 36%, 6h 27%, 12 h 12%, 1 day 21%	as late as possible. 42% under 1h	75- 84 years – 22% under 1h	–
Latest delivery of the luggage at the target location	same time as the person 72%, same day 26%	55% at the same time as the person	48% at the same time as the person	from 3 pieces of luggage: 56,8% at the same time as the person
Location for the pickup of the luggage (actual journey)	45% directly at the residence door, 47% at the train station	50% directly at the residence door, 33% at the train station	The older the person the more they opt for “directly at the residence door” (between 75 and 84 years of age – 69%).	without large pieces of luggage → train station; with large pieces of luggage (from one piece) → directly at the residence door.
Location for the delivery of the luggage at the destination (actual journey)	38% at the Hotel, 50% at the train station	40% hotel, 40% train station, 17% another address	The older the person the more they opt for “at the hotel”.	–
In which part of the day the pickup and delivery should take place?	57% in the evening, 49% at the weekend, 45% in the forenoon	58% in the forenoon; – at the weekend 56%; less in the evening 47%, thereby more in the afternoon 38%	–	The bigger the pieces of luggage, the more there is the wish for a delivery time slot in the forenoon or in the afternoon.
Set or chosen time slot	75% chosen time slot	63% chosen time slot	–	70% chosen time slot ( from 2 large pieces of luggage)
Size of the time slot	1h 36%, 2h 51%	–	–	–

In summary, the survey showed that fringe groups were especially interested in using the service. Concerning needs and demands, the results showed that people who would likely use the service were willing to assume compromises and made smaller demands on the service. For example, all interest groups expressed less demand that the luggage had to be at their destination at the same time they themselves arrived.

With regard to the location for the pickup and delivery, the main groups would particularly like a pickup or delivery directly at the residence door. That would certainly be a sensible configuration since the online survey of people not travelling by train as well as the survey of those in the rehabilitation centres showed pickup or delivery directly at the residence door as being the favourite choice.

In conclusion, one more positive remark about the system should be made. The wish of the public for a pickup/delivery time slot of two hours would certainly be accomplishable.



Figure 4 Size of the time slot for the delivery or pickup

## References

There are no external references. The whole paper is based on the internal project results including surveys (project “GepäckLoS” → <http://GepaeckLoS.netwiss.at>)





## PROTOTYPE RAILWAY WAGON WITH ROTATABLE LOADING PLATFORM AND CONCEPT OF INNOVATIVE INTERMODAL SYSTEM USAGE

Tadeusz Niezgodą, Wiesław Krason  
*Military University of Technology, Poland*

### Abstract

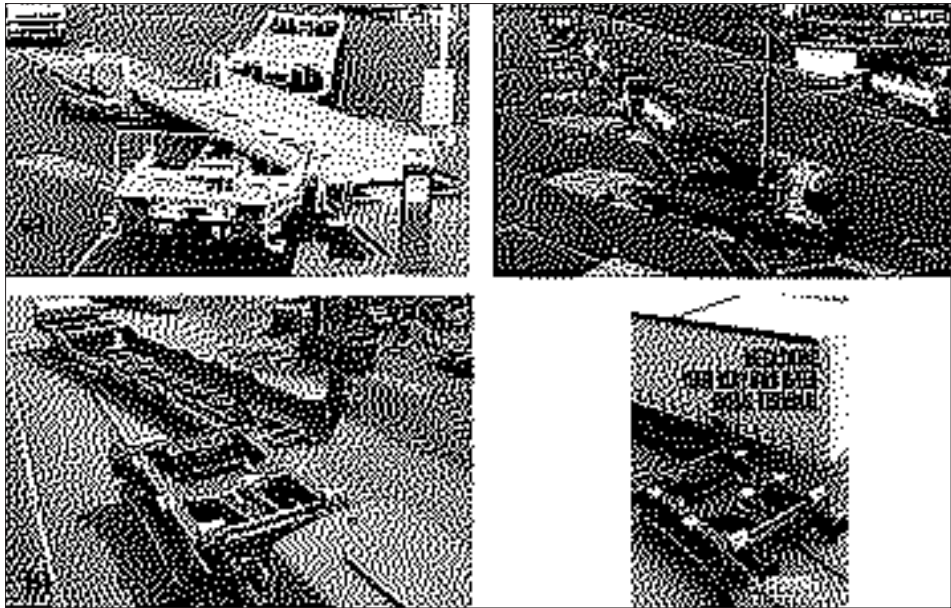
An innovative system proposed in the paper is based on a special railway wagon with a rotatable, low and flat loading floor. It can be used for transporting various types of vehicles, for example, tractors, trucks, trailers, semitrailers, cargo containers. The railway system using special wagons allows quick and convenient self loading and unloading of vehicles and containers (no cranes needed); no platform infrastructure is required, but hardened, flat, surface; no need for hubs, terminals or special logistics; each wagon can be operated separately. The selected aspects of the idea and a project of a special wagon for intermodal transport were discussed in authors' earlier papers. A prototype version of the wagon with a rotatable load platform is presented shortly in the paper. The idea of an intermodal system based on the innovative railway wagons and the constructional solutions used for it is presented in the paper as well. A technology presented in the paper allows elimination of expensive terminal loading devices from the utilization. In relation to a presently utilized construction of such a type (e.g. Moda Lohr and other), the advantages of the presented system are as follows: applying of repeatable wagons-platforms with an automatic rotating body for fast easy and safe loading and unloading of trucks without additional crane devices, constructional dimensions of the wagon with the load in the form of a semitrailer up to 4 m meet requirements of GB1 gauge, relatively simple and cheap infrastructure of the proposed system enabling cheap, ecological and safe transport of truck tractors with a semitrailer with a total length of 17 m, a weight up to 40 tons and low exploitation costs of such a system.

*Keywords: intermodal transport, special railway wagon, rotatable platform, rail-road system, semitrailers transport*

### 1 Introduction

In European railway transport, in recent years, there have been implemented intermodal systems based on horizontal or vertical reloading or others [1]. These systems require developed reloading terminals equipped with, for example, vertical reloading devices of accurate load capacity or other expensive and complicated devices enabling loading and unloading activities. The latest solution is the system of transportation of TIR type trucks with the use of railway developed by French company Moda Lohr [2] and Megaswing wagon built by Swedish company Kockums Industrier [3]. Figure 1 presents new intermodal systems developed by the above mentioned companies. Moda Lohr system requires extended infrastructure, especially, railway platforms as well as proper maintenance of the platform devices. Megaswing wagon is equipped with a low-loader rotating platform, which is rotated in respect to an asymmetrically located rotating junction, placed at the rear part of the wagon over its 'over-bogie' part.





**Figure 1** Wagons for trucks semitrailers transportation: a) developed by French company Moda Lohr [2], b) Megaswing developed by Swedish company Kockums Industrier [3].

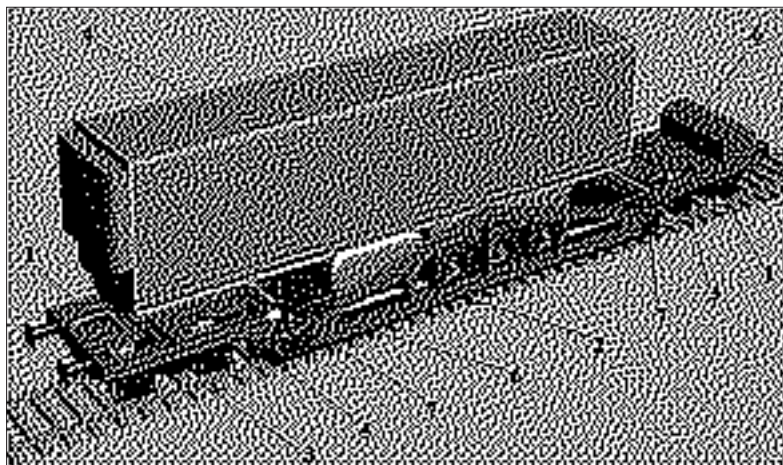
The idea of an intermodal system based on the innovative railway wagons and the constructional solutions used for it is presented in the paper. The system is based on a special railway wagon with a rotatable, low and flat loading floor. It can be used for transporting various types of vehicles. A technology presented in the paper allows elimination of expensive terminal loading devices from the utilization. A rail-road system for the semitrailers transport adjusted to the present condition of the existing railway infrastructure in Poland is developed.

## 2 Construction of the wagon in a prototype version

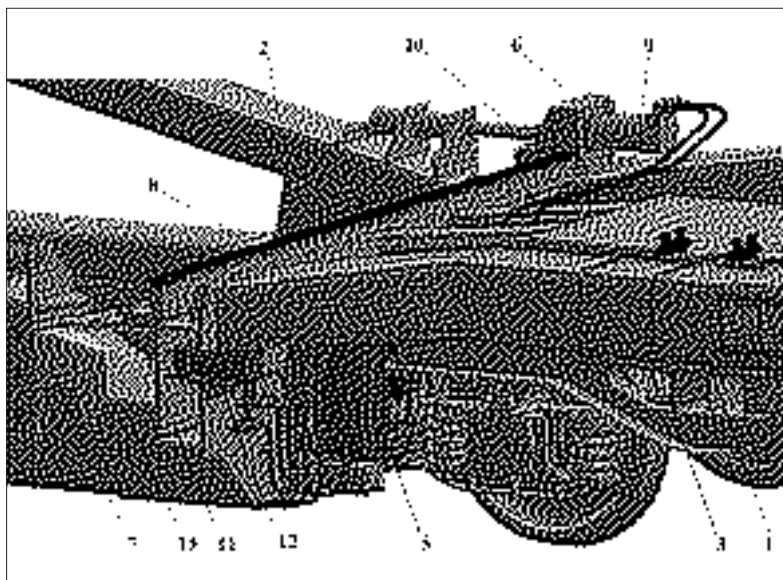
A prototype railway wagon with a rotatable platform for an intermodal system is developed in the Laboratory of Materials Strength of the Department of Mechanics and Applied Computer Science, Military University of Technology [4, 5]. Due to constructional assumptions in which transport of standard semitrailers of height of up to 4 m and standard biaxial rail bogies of Y25 type has been expected, maintenance of a gauge is possible by dint of lowering the wagon floor with maintaining the minimum distance of 130 mm from the frame bottom to the head of the rail and application of a special construction of the frame with the thickness of less than 70 mm in the central part of the wagon. A considered wagon consists of the following elements: chassis with biaxial standard Y25 bogies, frame, platform body, pneumatic systems, buffer devices, other external devices, electric equipment and hydraulic systems. A general view of a prototype version wagon prepared for transport and with a loading platform rotated to the loading-unloading position is presented in Figure 2.

According to this solution (Fig. 2), a wagon has been equipped with a low located frame of the chassis (1) meeting the requirements of gauge GB1 and a rotatable platform of the body wagon (2) with a strengthened construction of tailboards equipped with rotatable rolls located under the end edges of the platform. The platform is rotated in respect to a chassis and a loading/unloading platform owing to application of a rotating junction located in the central part of the wagon. Moreover, the wagon is equipped with an over-bogie part of the frame (1) located over standard bogies (3) on the both ends of the chassis. Additionally, the wagon can be equipped

with stabilizers in the form of additional hydraulic supporters (5) fixed – two on each side of the frame – under a lowered plate of the chassis and adjusted for lifting the wagon on the rails during loading and unloading. The rotatable movement of the loading part of the body (2) is extorted by mechanisms (6) located on the both sides of the over-bogie part of the wagon (Fig. 2 and 3). It consists of a plate with a fixed toothed bar (8), hydraulic engine (9) driving the mechanism of rotation, toothed wheel cooperating with toothed bar and holder (10).



**Figure 2** A view of a prototype wagon with a loading platform after loading/unloading process (in transport position): 1 – frame of the chassis (over-bogie parts), 2 – rotatable platform, 3 – Y25 bogies, 4 – semitrailer with load, 5 – hydraulic supporter, 6 – mechanism of the load platform rotation, 7 – tailboard locks.



**Figure 3** A view of an over-bogie part with: 5 – stabilizing supports, 6 -mechanism rotating the wagon loading platform, 7 – tailboard hook – locks, 8 – toothed bar cooperating with toothed wheel, 9 – hydraulic engine driving the mechanism of rotation (6), 10 – holder, 11 – wedge blocking of hook-locks, 12 – hydraulic actuator, 13 – raceways on which the hooks move.

A mechanism blocking rotation of a rotatable platform during transport of the load (a semi-trailer – 4 in Fig. 2) is very important from a functionality and strength point of view of the considered system of the constructional wagon. Construction of such a lock (7) – Fig. 3 allows only transmission of longitudinal load, therefore it does not block rotation of the platform and its movement in a transverse direction. This function is performed by a wedge (11) which is pressed to a lock-hook (7) and blocked with the use of a hydraulic actuator (12). The moving platform, while rotating, is supported on the central rotatable node in the centre of the wagon and on two raceways (13) on which the hooks move.

### 3 Cooperation of a special wagon with loading ramp – idea of the special wagon operation in kinematic simulations

A detailed geometrical model of the railway wagon with a rotatable platform has been built. The model served also to prepare kinematic simulations of the real cooperation of wagon subsystems with the rotatable platform of the body. These analyses enabled estimating the fluency of motions of the cooperating wagon mechanisms, and made it possible to detect potential cuts and initial identification of critical states concerning the run of loading/unloading operations and a proper transport phase from a constructional-operating point of view. The discussed model is used in the paper to demonstrate the principle of operations and to visualize basic functions of the railway wagon for transport of trucks.

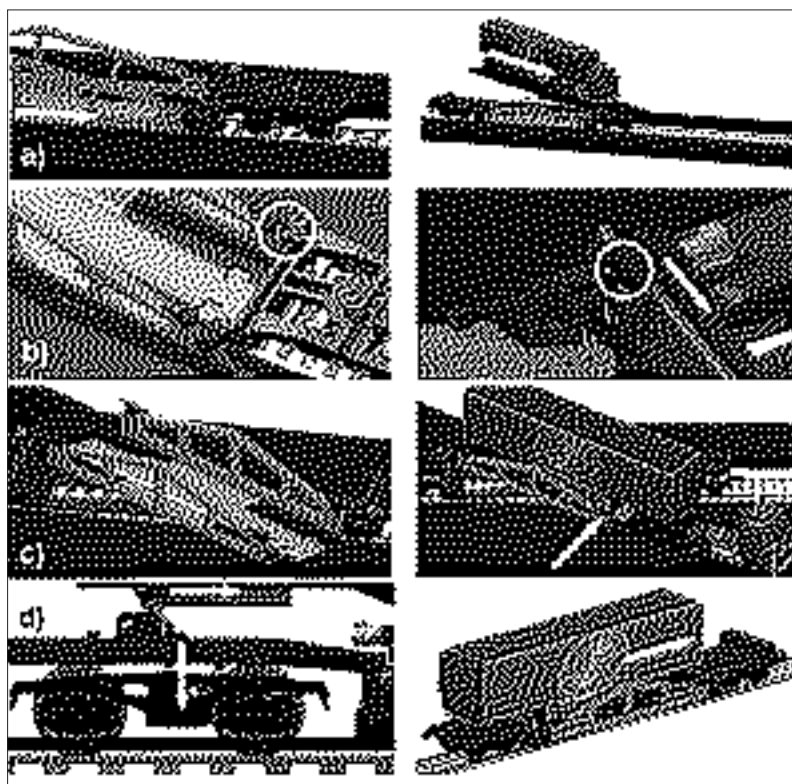


Figure 4 A view of selected operations during loading process: a) onset of an empty wagon onto the railway ramp, b) preparation for rotation of the loading platform, c) rotation of the loading platform in respect to the wagon frame and tractor's downhill drive from the railway ramp, d) preparation of the wagon with semitrailer to departure.

Fig. 4 presents visualization of cooperation of moving wagon parts and the wagon–tractor with a semitrailer system during loading/unloading operations. Numerical methods are used to simulate realization of individual sequences of the following operations:

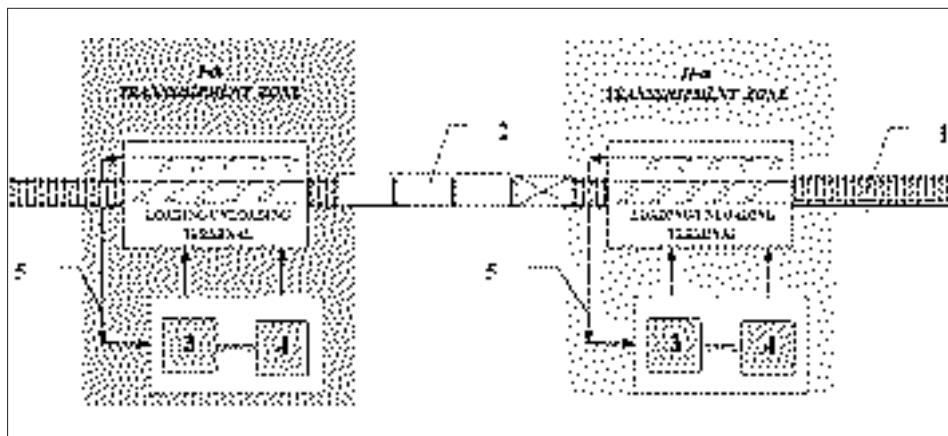
- a) onset of an empty wagon onto the loading-unloading ramp,
- b) preparation for rotation of the loading platform, i.e., supporting the chassis on the heads of rails with the use of stabilizing supports and unfastening of tailboards locks,
- c) rotation of the loading platform in respect to the wagon frame and the loading/unloading ramp, onset of a tractor with a semitrailer onto the loading/unloading ramp,
- d) driving the tractor-semitrailer set onto the loading platform and unfastening the tractor,
- e) tractor’s downhill drive from the railway ramp,
- f) rotation of the loading platform of the wagon along with a semitrailer to the transport position,
- g) preparation of the wagon to departure, i.e., fastening the tailboards locks blocking the rotatable movement of the platform in respect to the wagon during the travel with the load and raising the supports stabilizing the wagon through resting the frame on the rails,
- h) onset of the wagon with a semitrailer onto the loading/unloading ramp.

## 4 Intermodal system

### 4.1 Idea of the intermodal system based on the innovative wagon

An idea of the intermodal system and simulations of basic functions and loading/unloading operations with innovative railway wagons and the used constructional solutions are presented in the paper.

The main part of the proposed intermodal system is a train consisting of a locomotive and a set of innovative wagons with the rotatable platform – Fig. 5. The wagon construction, optimized through application of modern design methods [6, 7, 8, 9], allowed achievement of suitable strength and considerable stiffness during the transport of the semitrailer with the load of total weight up to 40 tones. A characteristic property of the described solution is high resistance to loads assured through application of accurately stiff locks-joints fixing the moving loading platform to the over-bogies part of the frame in the configuration of the wagon ready for transport [10].



**Figure 5** Proposal of the intermodal system with a train consisting of a locomotive and a set of innovative wagons with the rotatable platform: 1 – terminal railway track, 2 – train consisting of a locomotive and a set of innovative wagons, 3 – car park for tractors, 4 – warehouse/car park for semitrailers, 5 – access and maneuvering roads.



An important part of each intermodal system is a railway station that allows execution of loading or unloading of semitrailers. To load and unload such sets, there are needed final railway stations or intermediate railway stations with an access to a track (one or more) and a ramp with suitable dimensions enabling loading-unloading operations [1, 10]. Therefore, the innovative system for intermodal transport with the use of wagons with rotatable loading platform additionally consists of loading-unloading terminals – Fig. 6.

It is assumed that tractors serving for loading and unloading of semitrailers would operate in direct neighbouring of loading-unloading terminals. Special railway wagons can be operated simultaneously during a loading/unloading process. One or more tractors may be used. Their purpose would be delivering the semitrailers with freight intended for transportation to the designated terminal with a waiting set of special wagons and then loading the semitrailers with a freight on the wagons. After the semitrailer is detached and left on the wagon, the tractor can be reused for transport and loading the semitrailer waiting on the parking lot. If a greater number of tractors is used (simultaneous loading-unloading operation – Fig. 6), the time needed to stop the train at the terminal is reduced proportionally.

Loading-unloading terminals can be located in convenient border points having standard railway lines well communicated with junction stations in a particular country with a special attention paid to transshipment border stations on the main west-east and north-south directions for servicing intermodal transports over long distances.

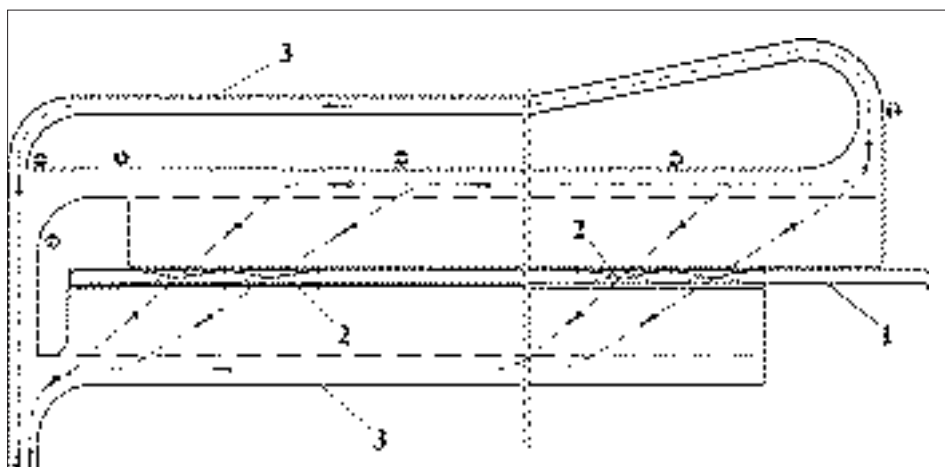


Figure 6 Terminal and traffic organization during loading of the set with special wagons: 1 – terminal railway track, 2 – special wagon with semitrailer, 3 – access and maneuvering roads.

## 5 Conclusions

The subject of consideration is a rail-road transport system adjusted to the present condition of the existing railway infrastructure in Poland. A developed technology allows elimination of expensive terminal loading devices from the utilization. Such a solution enables shortening the loading time and lowering the direct costs of loading terminal operations. An important advantage of the proposed solution is a possibility of trains production by national companies. Introduction of an innovative system of truck sets developed at Military University of Technology will results in the following profits:

- lowering the social costs of transport through its safety improvement as well as lowering the negative interaction of the road transport on the natural environment,

- improvement of the railway infrastructure condition through competent usage of the European Union's structural funds,
- reduction of expenditures for road infrastructure maintenance through limitation of degradation of routes resulting from limitation of road sets,
- improving the quality and extending the range of railway transport services,
- an increase in competition of national transporters within the framework of liberalization of the European Union's transport policy.

## References

- [1] Mindur, L., others: Transport technology, Wydawnictwo Naukowe Instytutu Technologii Eksploatacji – Państwowy Instytut Badawczy, Warszawa-Radom, 2014.
- [2] [www.lohr.fr/index\\_gb.htm](http://www.lohr.fr/index_gb.htm), Rail-road, LOHR 11, 2009.
- [3] [www.kockumsindustrier.se/en-us/start/](http://www.kockumsindustrier.se/en-us/start/), Intermodal wagons-MEGASWING, 2011.
- [4] Military University of Technology: A railway wagon and a mechanism for rotating and blocking a loading floor of a railway wagon for combined transportation, EU Patent EP 2 532 562 A1, 2012.
- [5] Military University of Technology: A railway wagon with a rotatable loading floor", EU Patent, EP10461528, 2013.
- [6] Niezgoda, T., Krason, W., Barnat, W.: Idea and tests of the railway wagon with a rotatable platform for intermodal transport, 2<sup>nd</sup> International Conference on Road and Rail Infrastructure CETRA, 1041-1047, 2012.
- [7] Krason, W., Niezgoda, T., Damaziak, K.: Some aspects of numerical tests of special railway wagon for intermodal transport of heavy semitrailer, European Congress on Computational Methods in Applied Sciences and Engineering ECCOMAS, Wien, 2012.
- [8] Krason, W., Niezgoda, T.: FE numerical tests of railway wagon for intermodal transport according to PN-EU standards , Bulletin of the Polish Academy of Sciences, Technical Sciences, Vol. 62, No. 4 , October 2014, pp. 843 – 851, 2014.
- [9] Military University of Technology, The innovative technology of railway transport of TIR type trucks, National Center of Research and Development, Report of MUT, Warsaw, 2012.
- [10] PN-EN: 13232-1, Railway applications, PN-EN Standards, Warsaw, 2004.





## IMPACT OF THE ENVIRONMENT OF AN ORGANISATION ON ITS CAPACITY FOR THE DIFFUSION OF INNOVATIONS: ITT APPLICATION AND BIM ADOPTION

Sanjana Buć<sup>1</sup>, Miroslav Šimun<sup>2</sup>

<sup>1</sup> Institut IGH, d.d., Croatia

<sup>2</sup> Zagreb University of Applied Sciences, Croatia

### Abstract

Architecture, Engineering and Construction (AEC) industry is an industrial branch in which innovations are introduced relatively slowly, whether they are new products and/or new or significantly improved production processes. Two principal phases of the process of diffusion of innovations within an AEC organisation were defined in the earlier conceptual model of diffusion of the Building Information Modelling (BIM) as an innovation: the initial phase which precedes the decision making on adoption of the innovation and the next phase – implementation. In this Paper it is attempted to recognise the influential factors of an organisation's environment on the initial phase of the diffusion of innovations within the organisation. A quality research was carried out on two expert groups: on the expert team for BIM, and on the expert team for asphalt technology. The latter team investigated innovative application of the Indirect Tensile Test (ITT) method for asphalt, according to the harmonised standard HRN EN, with the purpose of improving designing, i.e. dimensioning of asphalt courses in pavement structure. Each expert team recognised environmental influential factors and grouped them in three principal groups: factors of the general or social environment of the organization, factors of the business environment, and internal factors within the organisation. The Paper presents the analysis of the obtained research results for each group, as well as their comparative analysis. Influential environmental factors were defined, which impact the adoption of innovations in AEC organisations in the Republic of Croatia. This measurement instrument may be used to continue a research in order to rank and recognize those influential factors that should be acted upon primarily, with the goal of increasing the capacity of an AEC organisation for adoption of innovations.

*Keywords: diffusion of innovations, Building Information Modelling (BIM), Indirect Tensile Test (ITT), environmental factors*

### 1 Introduction

Common opinion is that innovations are introduced relatively slowly in Architecture, Engineering and Construction (AEC) industry. Many innovations in our country do not get appropriate feedback, among other things, because of our lack of information [1]. Two examples are discussed: innovative application of the Indirect Tensile Test (ITT) method for asphalt and Building Information Modelling (BIM) as an innovation. Identification of the actual parameter values of the stiffness module of asphalt is applied to verify critical stresses and strains that occur in layers of the pavement structure due to the given traffic load. In Croatia, outdated and inaccurate data on the properties of materials are used, which were obtained by testing the dynamic elastic modulus as a function of temperature, conducted 49 years ago [2].



As innovative application, ITT relates to the identification of stiffness module at exploitation temperatures of mixtures, types of hot asphalt mixtures currently used for road construction in Croatia, in order to obtain input parameters to check strains and stresses that occur in pavement structure [3]. Although BIM is perceived as an innovation that brings a number of benefits for all stakeholders in the realization of a construction project, BIM is not yet accepted worldwide in the expected volume and the expected rate of adoption [4]. According to Murphy [5], the problem of BIM implementation can be successfully solved if approached as implementation of innovation. BIM diffusion process at the level of organization has been identified within the theoretical framework of diffusion of innovations (DOI) [6]. The proposed model identified the following main groups of influential factors on the DOI in an AEC Organization: social and business environmental factors, internal organizational factors, previous related knowledge, perceived properties of an innovation, and communication channels. This paper presents a qualitative research of the impact of environmental influential factors of an AEC organization on its ability to acquire and assimilate an innovation. The research was carried out on the example of BIM and ITT as an innovation, with participation of experts from both fields, in order to investigate whether it is possible to recognize the environmental factors that influence the diffusion of innovation, regardless the type of innovation.

## 2 Innovation in construction

According to Guidelines for collecting and interpreting innovation data (“Oslo Manual”) from 2005, “An innovation is the application of a new or significantly improved product (good or service) or process, a new marketing method or a new organizational method in business practices, workplace organization or external relation”[7]. Slaughter [8] defines innovation as the actual use of non-trivial change and improvement in the procedure, product or system, which is new for the institution developing this change. The innovation is “any idea, practice or object that is perceived as new by an individual or other unit of adoption. It matters little, so far as human behavior is concerned, whether or not an idea is objectively new as measured by the lapse of time since its first use or discovery.” [9]. It is important that the idea is perceived as new by the individual.

### 2.1 BIM

Building Information Modelling (BIM) is defined in different ways in literature [10], [11], [12] but all the definitions have several key elements in common: the process of creating a digital model, combination of “smart” elements containing both qualitative and quantitative data, interoperability of data, integration of processes based on a high level of mutual cooperation of all stakeholders with a joint goal – to manage the structure efficiently throughout its entire lifetime. The result of this process is a “building information model” – “a digital representation of physical and functional characteristics of a facility, a shared knowledge resource for information about a facility forming a reliable basis for decisions during its life-cycle” [13]. According to the Oslo Manual, it follows that BIM is both a product innovation and a process innovation [7]. According to the classification model [8], BIM is a systemic innovation, since BIM requires changes in information and communication terms in different organizations, which leads to complex problems of interoperability, which depends on the interconnectedness and cooperation of stakeholders, and on cultural changes, all aimed at creating a unique system in order to raise the quality of execution.

### 2.2 ITT

Resilient or reversible module is the ratio of repeated stress and reverse (resilient) relative strain due to repeated short-period stress corresponding to the load of wheels of a moving

vehicle. Resilient module describes the effectiveness of different layers of road structure on the stress distribution within the pavement structure, resulting from traffic loads. The theory of elasticity is used to predict the relative resilient strain or shift during mechanistic design of flexible pavement structures. In laboratory, resilient modulus of asphalt mixtures is usually determined by indirect tensile testing ITT, [14]. Testing is not destructive because stresses are very low.

According to the results of a previous research [3] the determined moduli of stiffness at four temperature values, confirm that the ITT method – indirect tensile tests can optimize the composition and properties of asphalt mixture. Based on the obtained results, the parameters of actual performance of asphalt pavement structures will be used during exploitation. This innovation contributes to reducing deviations from the actual values in calculations of stresses and strains of individual layers due to traffic load, and thus optimizing the process of structural design, and also of quality control of built asphalt pavement structures.

### 3 Absorptive capacity for the diffusion of innovations

The diffusion is “the process by which an innovation is communicated through certain channels over time among the members of a social system” [9]. The definition itself contains the four basic elements of diffusion of innovation: (1) innovation, (2) communication channels, (3) time, (4) social system.

The process of BIM diffusion at the level of organization, according to the conceptual model [6], takes place in two main phases: the initial and the implementation phase. The initial phase consists of two sub-phases: “Awareness of the need for BIM adoption” and “Feasibility study and proposal to adopt”, after which the decision on BIM adoption is reached. If the decision is positive, the implementation phase follows, which consists of the following: “Adapting the organization to BIM”, “Training and user support for wider use”, “Sustainability of the continuous application” and “Evaluation and improvements”. The model also identifies main groups of influential factors on the diffusion of innovation (BIM) in an AEC Organization (Fig. 1).



Figure 1 Conceptual model of BIM diffusion in AEC organizations [6]

The conceptual model of the diffusion of innovations in construction industry on the example of BIM diffusion as innovation is based on the theoretical model of the diffusion of innovation, but it is also supplemented with the basic tenets of the absorptive capacity concept.

The most cited contribution to the development of the theory of absorptive capacity is the work of Zahra and George in 2002 which defined the absorptive capacity (ACAP) as “set of organizational routines and processes by which firms acquire, assimilate, transform and exploit knowledge to produce a dynamic organizational capability” [15]. The following four dimen-

sions of ACAP arise from the very definition: acquisition, assimilation, transformation and exploitation. The authors define “acquisition” as “a firm’s capability to identify and acquire externally generated knowledge that is critical to its operations.” “Assimilation” refers to the firm’s routines and processes that allow it to analyze process, interpret and understand the information obtained from external sources. “Transformation” refers to “a firm’s capability to develop and refine the routines that facilitate combining existing knowledge and the newly acquired and assimilated knowledge.” The fourth component “Exploitation” refers to “the ability of the organization based on processes that allow the organization improvement, expansion and use of existing competences or create new ones by applying the adopted and transformed knowledge in its operations.”

### 3.1 Organization environment

Each organization acts under the influence of the environment in which it conducts business (Fig. 2). According to Buble [16], “the environment denotes the totality of participants that influence the business operation of a company, and which need to be respected by the management during decision making”. In doing so, he distinguishes external environment which is divided into general or social environment and business environment or the environment of the task and the internal environment. While the main characteristic of the general or social environment is the fact that is not under direct control of the company, business environment or task environment is constituted by active participants in the immediate environment of the organization that have an influence on its capacity to service this environment. The internal environment represents “the part of the total company environment that is contained within itself” [16]. It can be fully influenced and controlled (Fig. 2).

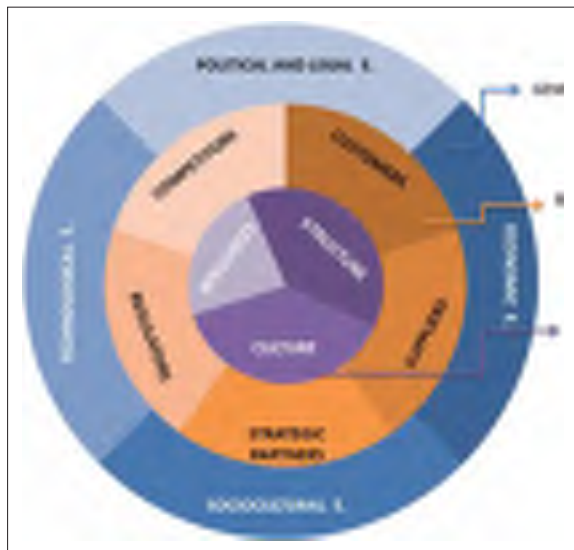


Figure 2 Organization environment according to Buble [6]

The research, the results of which are presented in this paper, is carried out in order to identify the environmental influential factors that affect the capacity of the AEC organization for the acquisition and assimilation of innovation, i.e. the ability of the AEC organization to recognize and accept the external innovative knowledge, and to understand and process it, in order to enable the management making decision whether to start the implementation phase of such innovation.

## 4 The process of defining the key environmental factors

The process of defining the key environmental influential factors was carried out in three phases. The first phase was creation of the initial set of items. It was followed by the phase of testing content validity of this set of items through a qualitative research by a panel of experts, for each of innovations separately. The content validity and construct validity was rated for each expert group. The third phase consisted of a comparative analysis of the research results for both innovations which resulted in certain conclusions.

### 4.1 Creating the initial pool of items

Creating the initial pool of environmental influential factors of the organization consisted of three groups of factors: external social, external business factors and business environment within the organization. Although it is not possible to determine the exact number of items that the initial set should contain, the general rule is: “the larger initial set, the better.” [17]. The initial set of items for this research resulted from the literature review and published research results, and consisted of 22 items in total social environmental factors, 12 items in the group of business environment factors and 39 items in the group of internal environment factors, i.e. total of 73 items. The qualitative analysis of gathered information about environment factors, the initial set of items is narrowed down to total of 46 factors: 12 factors of the social environment, 13 businesses and 21 factors of internal environment.

### 4.2 Testing the content and construct validity of environmental factors

To ensure the content validity of an instrument, in the next step of the performed research, the experts’ replies were collected through a questionnaire that was submitted them by e-mail. A letter explaining the objectives and method of completing the questionnaire was attached to the questionnaire. The questionnaire was prepared in the form of MS Excel sheets, and it consists of 46 factors of the organization environment. The comments contain explanations of certain terms used in the questionnaire. The respondents were supposed to determine the importance of each factor for the acquisition and assimilation of innovation (BIM / ITT) at the level of organization in construction industry, and by selecting one of the propose answers (1 not a relevant factor, 2 important, but not decisive; 3 essential; 0 I cannot answer). In addition, they could make comments for each of the factors as further detailed observation with regard to its relevance, clarity of description, etc.. A panel of experts involved in the research consisted of 10 individual experts for each example of innovation. Lawsche equation (content validity ratio, CVR) [18] was used for rating of the content validity:

$$CVR = \frac{(n - N/2)}{N/2} \quad (1)$$

where N is total number of responses, n is frequency number of panelists who evaluated the item with 2 or 3 (a positive response to the assessment of the individual environmental influential factors). The minimum value of CVR coefficient of 10 respondents is 0.62 [18].

The questionnaire also asked the panelists to classify each of the listed environmental factors in one of groups: SO – General or social organization environment, PO – Business organization environment, IT – Internal organization environment and O – Other (factor not appropriate for any of the listed groups of environmental factors). Although the respondents categorized all offered factors, only those factors that have passed the previous CVR test are included in the analysis of construct validity of the instrument. If an item is consistently classified into a

specific category, it is considered that it has the validity of convergence with that construct and discriminant validity with others.

#### 4.2.1 Expert panel for BIM

Expert panel for BIM consisted of four university professors, four experts employed in the AEC organizations and two experts from organizations that sell appropriate software. After analyzing their responses, a total of 29 items passed CVR test. After sorting environmental factors per groups, total of 25 items remained (Table 1). The calculated Cohen's kappa coefficient is 0.72, which shows good agreement of experts participating in this research with the classification factor according to theoretical divisions and results of previous researches in accordance with the literature. Further review of comments of respondents and qualitative analysis of other factors provided a list of 27 environmental factors of the AEC organization that affect its acquisition and assimilation of BIM (Table 1).

**Table 1** Results of research of environmental factors for BIM

Target category	Initial	After CVR test	After sorting	Qualitative analysis
Internal environment	21	12	11	12
Business environment	13	10	9	10
Social environment	12	7	5	5
<b>TOTAL</b>	<b>46</b>	<b>29</b>	<b>25</b>	<b>27</b>

#### 4.2.2 Expert panel for ITT

Expert group of respondents for ITT consisted of four laboratory experts, three university professors and three designers of pavement structures. Total of 27 items passed CVR test. After sorting into individual groups, 9 internal environmental factors, 7 factors of business and 4 factors of the social environment were recognized for which the expert team agreed to have an impact on the acquisition and assimilation of ITT in organizations in the construction industry. The calculated Cohen's kappa coefficient is 0.6 and shows good agreement of experts participating in this research with the classification of factors according to the analysis of literature. Qualitative analysis of other factors provided a list of 23 environmental factors of the AEC organization that affect its acquisition and assimilation of ITT (Table 2).

**Table 2** Results of research of environmental factors for ITT

Target category	Initial	After CVR test	After sorting	Qualitative analysis
Internal environment	21	14	9	10
Business environment	13	7	7	7
Social environment	12	6	4	6
<b>TOTAL</b>	<b>46</b>	<b>27</b>	<b>20</b>	<b>23</b>

### 4.3 Comparative analysis of environmental factors

The comparative analysis of research results of the environmental influential factors of the organization on the acquisition and assimilation of innovation in the example of BIM and ITT has shown that 9 internal environmental factors were recognized as important influential factors for the acceptance of innovation in AEC organization. The Cohen's kappa for these two groups of experts related to the issue of internal factors amounts to 0.62 and shows good agreement of experts in their assessment.

However, Cohen's kappa coefficient for the group of business environmental factors is 0.20, which represents a poor agreement of the two expert groups (in only six factors). For the group of social environmental factors, the calculated Cohen's kappa coefficient is negative, which means that there is no agreement of expert groups in assessing the significance of these factors (they agree only for two factors). The list of common environmental factors (recognized by both expert groups) is shown in Table 3.

**Table 3** Environmental factors of AEC organization that influence the acquisition and assimilation of innovation

<b>INTERNAL ENVIRONMENTAL FACTORS</b>
<ul style="list-style-type: none"> <li>· Support of senior management at the organization level</li> <li>· Level of IT/ technological expertise of employees</li> <li>· Level of IT infrastructure of the organization</li> <li>· Standpoint of the organization management on competition and entrepreneurship</li> <li>· Available funds that the organization intended for the procurement and maintenance of IT infrastructure and training of employees to adopt new knowledge and technologies</li> <li>· Formalization of rules, procedures and communication channels at the organization level</li> <li>· Availability of human resources with the required knowledge, skills within the organization</li> <li>· Systematic training of the organization employees</li> <li>· Available time within the organization for adoption of new knowledge and technologies</li> </ul>
<b>EXTERNAL BUSINESS ENVIRONMENTAL FACTORS</b>
<ul style="list-style-type: none"> <li>· Pressure of competition at national and EU level to accept innovation</li> <li>· Pressure of the construction sector at national and EU level to accept innovation</li> <li>· Implementation of innovation to meet the client's needs</li> <li>· Level of the market demand for a given innovation</li> <li>· Willingness of partners who collaborate with the organization for the adoption of new knowledge and technologies</li> <li>· Willingness of partners who collaborate with the organization for the adoption of new knowledge and technologies</li> <li>· Cooperation with foreign partners in research, educational and development projects</li> </ul>
<b>EXTERNAL SOCIAL ENVIRONMENTAL FACTORS</b>
<ul style="list-style-type: none"> <li>· Legislation through general and specific laws and technical requirements</li> <li>· Economic recession affecting the construction sector</li> </ul>

## 5 Conclusion

The problem of adoption of innovations at the AEC organizations can be seen as the diffusion of innovation throughout the organization, which firstly needs to develop its potential and realization absorptive capacities for external adoption of innovative knowledge. In such a process, the organization is influenced by the external social environment, business environment and internal environment of the organization itself. The results of the qualitative research carried out on examples of BIM and ITT as innovations in the construction industry show that it is possible to define the key factors of the internal environment of the organization regardless the type of innovation, and the impact of external environmental factors on the analysed cases is not unambiguously defined.

This research is limited by the fact that only two examples of innovation were investigated, a future research of some other examples of acceptance of innovation in the AEC organizations could supplement the conclusions reached.

Further research should be focused to the verification of the results of this research on the wider population of respondents in AEC organizations which would determine the intensity of influence of certain environmental factors that can help the organization management to undertake the necessary actions to improve its potential absorptive capacity to accept innovations.

## References

- [1] Žagar, Z.: Innovations in construction industry, *Građevinar* 52 (2000) 4, pp. 201-207
- [2] Dormon, G., Edwards, J.: Developments in the application in practice of a fundamental procedure for the design of flexible pavements, 2<sup>nd</sup> international conference on the design of asphalt pavements, 1967.
- [3] Šimun, M., Halle, M.: Indirect tensile test of asphalt mixture stiffness modulus, 3<sup>rd</sup> International Conference on Road and Rail Infrastructure – CETRA 2014, Split, 2014.
- [4] NBS: National BIM Report 2015, RIBA Enterprises Ltd, 2015.
- [5] Murphy, M.: Implementing innovation: a stakeholder competency-based approach for BIM, *Construction Innovation*, 14 4, pp. 433-452, 2014.
- [6] Buć, S.: Diffusion of Building Information Modelling as an Innovation: A Conceptual Framework for Research, 12<sup>th</sup> International Conference Organization, Technology and Management in Construction, Primošten, 2015.
- [7] OECD, Oslo Manual: Guidelines for Collecting and Interpreting Innovation Data, 3<sup>rd</sup> ed, OECD Publishing, European Commission, Eurostat, 2005.
- [8] Slaughter, E.S.: Models of construction innovation, *Journal of Construction Engineering and Management* 124, 3, pp. 226-231, 1998.
- [9] Rogers, E.: *The Diffusion of Innovations*, 5<sup>th</sup> ed. ur., New York: The Free Press, 2003.
- [10] Succar, B.: Building Information Modelling Maturity Matrix, *Handbook of Research on Building Information Modeling and Construction Informatics: Concepts and Technologies*, IGI Global, pp. 65-103, 2010.
- [11] Eastman, C., Teicholz, P., Sacks, R. Liston, K.: *BIM Handbook, A Guide to Building Information Modeling for Owners, Managers, Designers, Engineers, and Contractors*, 2<sup>nd</sup> ur., John Wiley & Sons, Inc, 2011.
- [12] Buć, S.: Building Information Modelling and Integration Solutions in Construction, Congress of Croatian Builders 2012., 15-17.11. 2012, Cavtat, 2012.
- [13] BuildingSmart, [www.buildingsmart.org/standards/technical-vision](http://www.buildingsmart.org/standards/technical-vision), 15.06.2015.
- [14] HRN EN 12697-26: Bituminous mixtures – Test methods for hot mix asphalt – Part 26: Stiffness (EN 12697-26:2004), First edition December 2001
- [15] Zahra, S. A., George, G.: Absorptive capacity: a review, reconceptualization, and extension, *Academy of Management Review*, 27, 2, pp. 185-203, 2002.
- [16] Buble, M.: *Management*, 4. ed., Split: Sveučilište u Splitu, Ekonomski fakultet, 2000.
- [17] DeVellis, R. F.: *Scale development: theory and application*, London: Sage Publications, 2003.
- [18] Lawshe, C. H.: A quantitative approach to content validity, *Personnel Psychology*, 28, pp. 563-575, 1975.





## COMPARISON OF DIFFERENT SURVEY METHODS DATA ACCURACY FOR ROAD DESIGN AND CONSTRUCTION

Vladimir Moser<sup>1</sup>, Ivana Barišić<sup>1</sup>, Damir Rajle<sup>2</sup>, Sanja Dimter<sup>1</sup>

<sup>1</sup> University of Osijek, Faculty of Civil Engineering Osijek, Croatia

<sup>2</sup> Vocational School of Construction and Geodesy Osijek, Croatia

### Abstract

For road design and construction, survey data play very important role as a basic tool and a starting point for the development of the design. In addition to the quality of project design, accuracy and precision of survey data is also essential for project-to-field data transferring within road build. In this paper, survey methods and its precision will be presented in a view of two commonly used methods (GPS and total station) and some new technology (unmanned aerial system-drone). Special emphasis will be given to the potential use of drones in survey data for road design and construction, with presentation of the field research results on the example of urban roundabout.

*Keywords: survey data, accuracy, GPS, drone, total station*

### 1 Introduction

Road design is a complex activity involving the analysis of field conditions and evaluation of alternative solutions in order to obtain the best possible quality of the final product – the road. For quality project, accuracy of input data is essential. The accuracy of survey data will reflect on a road build conditions. Geodetic survey, as the basic input data for the development of road project is extremely important in terms of its precision and detail. Therefore, the issues around its development and content are defined by the relevant laws and regulations. Within the survey, it is important to know horizontal and vertical accuracy of provided data, particularly if there are also used for structure stake out.

Geodetic survey consists of two equally important parts whose accuracy equally affect the overall accuracy of the project: digital map or plan (usually digital cadastral plan – DCP) and topographic survey. DCP is usually obtained by digitizing analog cadastral maps and its vectoring [1]. Precision of this process is presented in Figure 1 on the example of the building from Vodenička Street in Osijek.

DCP is supplemented and overlapped by survey data. Points 1 and 2 are derived from the survey data while points 1' and 2' are within DCP. It can be seen that the differences in position are not negligible, and they can be 0.5 meters or more. It should be noted that DCP gained by digitalizing (scanning) of analog cadastral maps can not be increased by magnification of scanned plan detail or by using higher resolution [2].

In making surveys for the road design, particularly in urban areas, it is necessary for parcel boundaries on vectored DCP to be corrected by field survey data which will greatly increase its precision. Also, DCP does not contain terrain altitude data nor a sufficient number of detailed points for quality road design. Therefore, it is necessary to supplement it by field survey so the comparison of commonly used survey methods (total station and GPS) and new technology (unmanned aerial system-drone) are presented in this paper.





Figure 1 Comparison of vectorised DCP and survey data

## 2 Total station and GPS

The total station is a combination of electromagnetic distance measuring instrument and electronic theodolite. It can be used to measure horizontal and vertical angles as well as sloping distance of object to the instrument so it has been used for many engineering and construction applications. Besides that, it is proven to be an excellent tool for mapping complicated fault zones in vegetated and cliffy areas in geologic mapping [3]. Accuracy of this method in positioning detailed points is within 1 cm which is very important when displaying strictly defined surfaces on geodetic layers such as asphalt and concrete surfaces or within larger and more demanding projects. However, there are some external factors affecting accuracy of this method. As described in [4], for total stations using laser beam, type and colour of the reflecting surface will substantially affect the energy of the reflection of the laser beam, increasing the distance between the total station and the target leads to increase the errors in measuring the slope distances, accuracy of measured slope distance for the white surface is higher than the accuracy of any other surface colour and modern electronic surveying instruments may be affected by the capacity of instrument battery which may be worked for long time in the field.

The use of GPS (Global Positioning System) for surveying begun in the 1980s with data being post-processed as one of its main disadvantages. But during that time it was the only way to obtain centimetre-level positioning. In the early 1990s, RTK (Real-Time Kinematic) methods were used to obtain centimetre-level positioning in real-time making former GPS survey method very efficient [5]. However, even with the use of modern instruments, by GPS survey there is a possibility of local displacement of the entire recording (because of the point of view accuracy) so the best accuracy can be achieved by using relative relations within the area of one recording.

As an answer to continues tendencies in geodetic science and practice for a high accuracy and reliability of data with minimal material costs, GNSS (Global Navigation Satellite System) system is developed. This concept of networked reference GNSS stations include GPS – American system (Global Positioning System), GLONASS – the Russian system (Global Navigation Satellite System) and the European Galileo system which is still inactive. CROPOS (CROatian Positioning System) system consists of 33 GNSS reference station at a distance of 70 km distributed in a way to cover the entire Croatian territory for the purpose of collecting data from satellite measurements and calculating the correction parameters. This networked reference station systems allows the determination of points with an accuracy of 2-3 centimetres and for the vast majority of geodetic measurements, this precision is sufficient. However, accuracy on a level less than one centimetre can be obtained by a combination of GNSS RTK system with the use of laser sensors and transmitters.

### 3 Unmanned aerial system – drone

Photogrammetric method is very cost-effective for producing survey maps of long and narrow objects such as roads. Altitude component accuracy obtained by this survey method is about 10 cm. However, the basis for achieving desired accuracy level is carefully performed survey. Survey should be carried out within low vegetation season, when the ground and all objects are clearly visible, survey measure should be adjusted to the required accuracy and to make ground preparation for aerial survey by setting fotosignals (crosses) or clearly marking defined details and measuring and calculating their coordinates [6].

Today, in photogrammetric survey, unmanned aerial systems (UAS) or drones are increasingly used [7] from simple drones with elevation accuracy of approximately 10 cm to unmanned aircraft equipped with GNSS RTK system with elevation accuracy around 2-3 cm.

UAS were developed when navigation and mapping sensors were integrated onto radio-controlled platforms to acquire low-altitude, high-resolution imagery for military purposes [8]. Today, UAS have a range of potential environmental or commercial applications (emergency response, pollution detection, crop spraying, etc.), they can be deployed in surveillance applications against civilians, such as applications in policing and border surveillance or as a weapons [9]. Due to the low cost, fast speed, high manoeuvrability, and high safety of UAS systems for collecting images [10], there is also possibility for its various use in civil engineering.

Investigating potential use of UAS for surveying earthwork projects, Siebert and Teizer [10] described different influences on UAS performance and its characteristics. According to their research, UAS required only 3% of the conventional RTK GPS-based data acquisition time but evaluation of the UAS-generated photos for errors (blur and obstructions) required more time and the UAS photogrammetric mapping approach required about one third of the time a RTK GPS survey. The main advantage of an orthophoto from the UAS is a geometrically corrected aerial photograph that is projected similarly to a topographical map, displaying true ground position with a constant scale throughout the image. This can be very helpful for field engineers for the direct measurement of distances, areas, and positions, and in particular when creating cross-sectional views or other terrain map information. There are also some issues within UAS survey. Stronger thermal winds can cause air turbulences for the UAS resulting in some blurred photos. Finally, UAS operation in highly populated areas can be unsafe or unsecure for any bystanders (pedestrians or other traffic).

### 4 Field measurement

Within this research, UAS type Phantom 2 Vision+ (Figure 2) equipped with 14MP camera was used in order to obtain photogrammetric images and to evaluate accuracy of different survey methods. It is a Class 1 aircraft system according to valid Croatian regulations [11] with total weight about 1,3 kg.

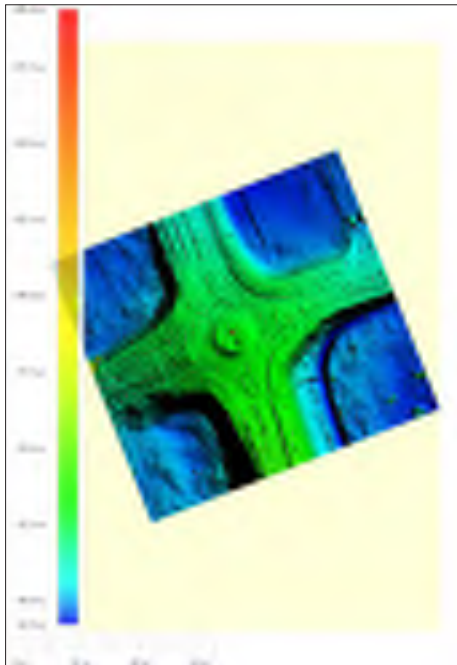


Figure 2 UAS Type Phantom 2 Vision+

Survey was conducted on roundabout in Trpimirova Street in Osijek. On the curbs on all four roundabout legs and on central island, 50 detailed point was marked and determined by four methods: a) survey by total station; b) survey by GPS RTK method using two satellite receiver TOPCON HIPER V type; c) survey by GPS CROPOS method using one satellite receiver TOPCON HIPER V type and d) survey by UAS photogrammetry with 60 m flight level. For aerial images processing, Quantum GIS software was used and four control points. Aerial image with marked control points is presented in Figure 3 while resulting digital terrestrial model (DTM) is presented in Figure 4.



**Figure 3** Aerial photo with marked control points taken by UAS



**Figure 4** DTM obtained by UAS images processing

## 5 Comparison of survey results

In order to compare accuracy of different survey methods and potential use of UAS for survey, results of UAS, GPS RTK and GPS CROPOS methods are analysed in terms of total station method. Elevation of detailed points obtained by a total station method are determined by trigonometric method with an accuracy of about 5 mm. Due to the fact that this method is the most accurate one, results of other used methods are compared in terms of total stations results. Results of UAS, GPS RTK and GPS CROPOS survey are presented in Figure 5 in terms of total station results. As it can be seen, the highest deviation is obtained for UAS method. GPS RTK and GPS COPOS methods presented similar deviations. However, GPS RTK method seems to have more reliable results due to continues values of deviations for all measured points.

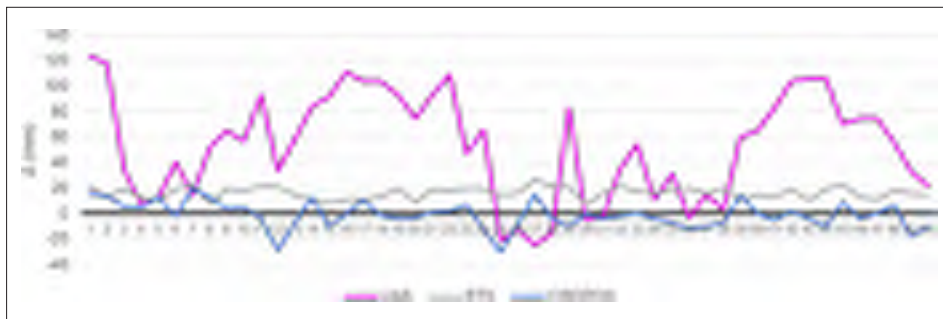


Figure 5 Survey results from different methods in term of total station method

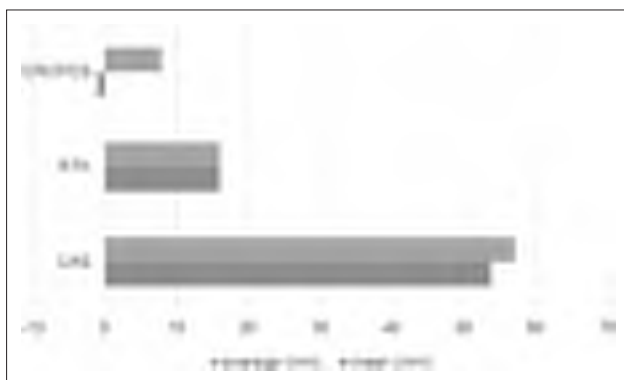


Figure 6 Average and mean deviations in term of total station method

In order to compare accuracy of different survey methods, in Figure 6 average and mean values of elevation deviation in term of total station results is presented. For GPR CROPOS method, mean value of deviations is -1 mm (measured elevations are in average 1mm lower compared to elevations determined by total station method). This result presents very high compatibility with total station measurements. However, average value of deviations is slightly higher, 8 mm, meaning that average deviation of this method compared to total station is 8 mm. For GPS RTK method, average and mean values of deviations are the same, 16 mm, meaning that this method gives the most uniform deviations. UAS method results have the highest deviations compared to total station results making this method the least accurate one. Average and mean elevation deviation is 54 mm and 57 mm respectively which also presents very reliable result. Even though this is significant loss of accuracy, it presents the potential of using UAS as alternative, relatively

cheap and fast survey method with applicability in projects which do not require highly accurate measures. In order to increase accuracy of any photogrammetric survey, it is necessary to select level of desired accuracy and on that basis, we can define survey parameters such as flight level, image overlapping and ground sampling distance (GSD) which defines recording resolution. Particularly, flight level adjustment could be used for increasing UAS survey accuracy but the safety issue must be addressed since UAS operation in highly populated areas can be unsafe or unsecure for any bystanders (pedestrians or other traffic) or for the UAV equipment itself.

## 6 Concluding remarks

For road design and construction, survey data play very important role as a basic tool and starting point for design development. Accuracy and precision of survey data is also essential for project-to-field data transferring. So, in order to define accuracy of different survey methods and defining its potential application, comparison of the results of four different survey methods were used. Results of this field study has shown that GPS RTK and GPS COPOS methods presented similar deviations from the total station results taken to be referent one. However, GPS RTK method seems to have more reliable results due to continues values of deviations for all measured points. On the other hand, UAS method results have the highest deviations comparing it to total station results making this method the least accurate one. Even though this is significant loss of accuracy, it presents the potential of using UAS as alternative, relatively cheap and fast survey method. UAS are growing new technology with increase market for small photogrammetric and remote sensing projects to which it offers an unbeatable price-performant service and product.

## References

- [1] Ljutić, K., Deluka-Tibljaš, A., Babić, S.: Mogućnosti unapređenja planiranja i projektiranja cesta uporabom računala, Zbornik radova Građevinskog fakulteta Sveučilišta u Rijeci XI, Rijeka, pp. 189.-205, 2008.
- [2] Paar, R., Marendić, A., Zrinjski, M.: Metoda određivanja visina kombinacijom GNSS-a i laserskog sustava, Ekscentar, 12, pp. 64-68, 2010.
- [3] Lavine, A., Gardner, J.N., Reneau, S.L.: Total station geologic mapping: an innovative approach to analyzing surface-faulting hazards, *Engineering Geology*, 70 (2003), pp. 71-91, doi:10.1016/S0013-7952(03)00083-8
- [4] Beshr, A.A.A., Abo Elnaga, I.M.: Investigating the accuracy of digital levels and reflectorless total stations for purposes of geodetic engineering, *Alexandria Engineering Journal*, 50 (2001), pp. 399–405, doi:10.1016/j.aej.2011.12.004
- [5] RTK (Real Time Kinematic) Basics for Surveying, [http://www.resourcesupplyllc.com/pdfs/RTKBasics\\_SurveyGradeGPS.pdf](http://www.resourcesupplyllc.com/pdfs/RTKBasics_SurveyGradeGPS.pdf), 13.4.2016.
- [6] Brajković, D., Bušelić, Lj., Remeta, I.: MX Road u projektiranju, *Prometnice – Nove tehnologije i materijali*, Dani prometnica 2010, Zagreb, 2010., pp. 241-272
- [7] Kolarek, M.: Bepilotne letjelice za potrebe fotogrametrije, *Ekscentar*, 12, pp.70-73, 2010.
- [8] Colomina, I., Molina, P.: Unmanned aerial systems for photogrammetry and remote sensing: A review, *ISPRS Journal of Photogrammetry and Remote Sensing*, 92 (2014), pp. 79–97, doi: 10.1016/j.isprsjprs.2014.02.013
- [9] Finn, R. L., Wright, D.: Unmanned aircraft systems: Surveillance, ethics and privacy in civil applications, *Computer law & security review*, 28 (2012), pp. 184-194, doi:10.1016/j.clsr.2012.01.005
- [10] Siebert, S., Teizer, J.: Mobile 3D mapping for surveying earthwork projects using an Unmanned Aerial Vehicle (UAV) system, *Automation in Construction*, 41 (2014), pp. 1–14, doi: 10.1016/j.autcon.2014.01.004
- [11] Ordinance on unmanned aircraft systems (in Croatian), *Official Gazette NN 49/15*

## 14 TRAFFIC SAFETY





## OPERATING SPEED MODELS ON TANGENT SECTIONS OF TWO-LANE RURAL ROADS

Dražen Cvitanić, Biljana Maljković

*University of Split, Faculty of Civil Engineering, Architecture and Geodesy, Croatia*

### Abstract

This paper presents model for predicting operating speeds on tangent sections of two-lane rural roads. The speed data of 20 drivers were continuously recorded along an 18 km long section of a state road D1. The data were used for determination of maximum operating speeds on tangents and their comparison with speeds in the middle of tangents i.e. speed data used in most of operating speed studies. Analysis of continuous speed data indicated that the spot speed data are not reliable indicators of relevant speeds. After that, operating speed models for tangent sections were developed. There was no significant difference between model developed using speed data in the middle of tangent sections and model developed using maximum operating speeds on tangent sections. All developed models have higher coefficient of determination than models developed on spot speed data. So, it was concluded that the method of measuring has more significant impact on the quality of operating speed model than the location of measurement.

*Keywords: operating speed, rural roads, spot speed data, model for prediction*

### 1 Introduction

One of the main causes of accident occurrence is the lack of geometric design consistency in terms of maintaining the desired travel speed [1-7]. A consistent road design ensures coordinated successive elements producing harmonized driver behaviour with no surprising events. There are many measures for design consistency evaluation among which the operating speed approach can be named as the most efficient measure [8].

In the past few decades many operating speed studies around the world have been conducted [9]. Majority of studies resulted in operating speed models on horizontal curves while there have been only a few attempts to develop speed models on tangents. There is an opinion that it is easier to model the operating speed on curves because of the strong correlation with the curvature of the alignment element [10] while the tangent speed depends on too many parameters [11], so it is hard to establish a reliable model.

The coefficient of determination  $R^2$  of curve speed models using just radius or curvature of the alignment element as explanatory variable is usually greater than 0.7. Including the approach tangent speed as an independent variable,  $R^2$  increases to more than 0.85 [12]. The results of speed models on tangent sections are not so good. In the analysis of 162 tangent sections on two lane rural highways [11] it wasn't possible to develop a model capable to describe the operating speed in the middle of tangent section because of its dependency on the elements before and after the section. So, researchers separated the tangents in four groups according to tangent length and sharpness of the preceding and the following curve. The corresponding coefficients of determination ranged from 0.55 to 0.84.



Federal Highway Administration (FHWA) developed speed profile models for lower speed highways (up to 64 km/h) for use in Interactive Highway Safety Design Model ISHDM 2010 release. Separate models were developed for short (< 45 m) and long tangents. Resulting  $R^2$  were pretty low. Coefficient of determination for short tangents model was 0.49 (the predicting variables were posted speed and radius of the curve). For longer tangents the posted speed, roadside hazard and length of tangent were found to impact the operating speed. Coefficient of determination of this model was 0.29. Ottesen and Krammes [13] developed operating speed model in curves with the approach tangent speed as an independent variable. Because it wasn't possible to develop an appropriate model for long tangents, a constant value of 97.7 km/h was considered as the desired speed on long tangents.

Although numerous studies have been developed in order to determine operating speeds, most of them were based on spot speeds and certain assumptions about drivers' behavior. The lowest speeds along the horizontal curves and highest speeds along tangents are considered to be the desired drivers' speeds. The researchers collected speed data at specific locations of a roadway, mostly at the middle point of horizontal curves and tangents, or 200 m before the end of tangents [14] using a radar gun or a similar device. Due to the lack of data, many models used the assumption of a constant speed along the horizontal curve. These assumptions may not be realistic [15]. Except for the unrealistic assumptions of driver behaviour, there are also some other disadvantages of spot speed data measuring, like cosine error, drivers changing their behaviour in the presence of test equipment, and human error when reading data from the device display [8].

Because of many shortcomings of spot speed measurement and with the development of technology, more and more researchers focus on continuous speed data. In the past decade, several operating speed studies have been conducted based on continuous measured data using a GPS device [10], [15], [16]. In this paper is analyzed whether shortcomings of spot speed measurement have impact on a quality of operating speed model.

## 2 Data collection

Test rides with vehicles equipped with a 10Hz GPS data logger, which measures speed, position, curvature, acceleration and heading, were carried on a 20 km long road segment of state road D1 (Figure 1).

The analyzed road segment is a two-lane rural state road with a relatively low traffic volume (the average annual daily traffic is about 1400 veh/day) and no intersections with major roads. The test rides were recorded during the day under optimal weather and free flow conditions, i.e. the headway between the test vehicle and the preceding or the following vehicle was greater than 5 seconds, in order to reduce the conditions not related to the geometry of the alignment [12], [14], [17].

Geometric characteristics of the road segment were obtained from the main road design and were verified using detailed geodetic as-built alignment data. Operating speed prediction models were developed based on the speed data from an 18 km long road segment, and the model validation was made with the data from an 2 km long segment of the road. The analyzed 18 km long section consists of 64 horizontal curves with radii varying from 85 to 1010 m and 64 tangents with lengths varying from 10 to 683 m. Geometric characteristics of the analyzed road segment are presented in Table 1.

The test driver sample consisted of 20 people with ages ranging from 23 to 60 years and with different driving experiences (from 5 to more than 30 years). The test vehicles were personal cars of different types and ages.

The values and locations of the maximum speeds on tangents section were determined from each ride's continuous speed profile. Also, the speeds in the middle of tangent section as well the speeds 200 m before the end of long tangents were recorded.



Figure 1 Analyzed segment of the state road D1

Table 1 Geometric characteristics of the analyzed road segment

Element	Geometric characteristics	Min	Max	Mean	St. Dev.
Curve	Radius [m]	85	1010	300	229
	Length [m]	40	440	147	99
	Deflection [°]	4	118	41	28
	Elevation [%]	2	7	3.4	1.4
Tangent	Length [m]	0	683	101	110
Spiral	Length [m]	0	60	32	10
Hor. Alignment	Grade [%]	0.5	6	2.1	1.5

The values of operating speeds  $V_{85}$  determined from the continuous speed data collected on the 18 km long road segment were used for analyzing the locations and values of speeds on tangents relevant to the development of operating speed models. After defining the relevant speeds, the operating speed prediction models for tangent sections were developed based on the geometric characteristics of the road.

### 3 Analysis of data

#### 3.1 Speeds on tangent sections

On short tangents the maximum speeds are dispersed all over tangent length, depending on the preceding and the following curve radius, as well as on the driving style of each driver. It wasn't possible to find a general rule for the location of the maximum free flow speeds. On long tangents (>150 m) most of the maximum operating speeds are located in the middle of the tangent. Table 2 presents the data about tangent length (T), the radius of curve before and the radius of curve after the tangent ( $R_{bef}$  and  $R_{aft}$ ), the location of the maximum operating speed, the maximum operating speed ( $V_{85_{max}}$ ), the operating speed 200 m before the end of

the tangent ( $V_{85_{200}}$ ) and the operating speed in the middle of the tangent ( $V_{85_{middle}}$ ) for some of the long tangents. Location 1 represents the maximum speed achieved in the first part of the tangent length, location 2 is for the second part and location 3 is for the third part of the tangent. The maximum difference between  $V_{85_{middle}}$  and  $V_{85_{max}}$  is 4%. The maximum difference between  $V_{85_{middle}}$  and  $V_{85_{200}}$  is 2%.

**Table 2** Speed data on long tangents.

Tangent No.	T [m]	$R_{bef}$	$R_{aft}$	location	$V_{85_{max}}$	$V_{85_{200}}$	$V_{85_{middle}}$
T18	336	350	250	2	87,8	86,6	97,7
T41	683	610	350	3	106,0	102,0	115,4
T43	230	840	320	1	98,4	97,9	109,1
T49	370	900	600	2	99,3	97,8	109,0
T51	470	350	310	2	94,9	92,4	104,8

The continuous data collected in this study showed that the assumptions that drivers reach their highest speeds in the middle of tangents, or 200 m before the end of tangent, and reach their lowest speeds in the middle of horizontal curves, are not realistic, in general. The average difference is 2% while the maximum difference is 4%.

Based on the results of data analysis, it can be assumed that the disparity of locations and values of the minimum and maximum speeds and other spot speed data measurements shortcomings could be a reason for low correlation between the operating speed on tangents and the geometric characteristics of the road for the models developed on spot speed data. Therefore, in this study, operating speed models for the maximum values of speed on tangents as well as for the speeds in the middle of the tangents were developed and compared.

## 4 Operating speed models on tangent sections

Operating speeds models for tangent sections are developed based on two sets of data. The first data set represents the maximum operating speeds on tangent sections, and the second set represents operating speeds in the middle of the tangents.

Operating speed models on tangent sections usually use linear regression, including variety of geometric characteristics of the alignment [11]. The independent variables chosen for the analysis in this study are tangent length (T), radius of the previous and following curve ( $R_{bef}$  and  $R_{aft}$ ), deflection angle of the previous and following curve, length of the previous and following curve, length of the previous and following spirals and grade.

Stepwise multiple linear regression indicated tangent length T, radius of the previous curve  $R_{bef}$  and radius of the following curve  $R_{aft}$  as statistically significant independent variables. Other variables did not have significant impact on the coefficient of determination. Several models were examined and the best fit model for predicting the maximum operating speeds on tangent section was:

$$\hat{V}_{85}^T = 13 + 6,92 \cdot \ln R_{bef} + 3,69 \cdot \ln R_{aft} + 2,97 \cdot \ln T \quad (1)$$

The model shows a high coefficient of determination  $R^2 = 0.85$  as well as an adjusted coefficient of determination  $R^2_{adj} = 0.85$ . In addition each coefficient has a high t-statistic with p value less than 0.0001, indicating the significant contribution of both variables to the model. Logarithmic function is used because it can describe the dependence between speed and tangent length better than a linear function. Namely, increasing the length of a short tangent results in significant increase in speed, while increasing the length of long tangents results in minor increase of speed, and this is described well by the logarithmic function. The quality of the model is further evaluated using mean absolute percentage error (MAPE) defined as:

$$MAPE = \sum_i \left| \frac{\hat{V}_{85}^T - V_{85}^T}{V_{85}^T} \right| \quad (2)$$

The overall MAPE for the data from the 18 km long segment is 3.1% and the maximum individual absolute percentage error (APE) is 11.5%.

Validation of the model is performed on the 2 km long test section outside the section used for model development. The MAPE of the model is 1.9 % and the maximum individual APE is 4.1%. The second set of data, i.e., the operating speeds in the middle of tangent, resulted in slightly different model parameters, but with same  $R^2$  and MAPE as the described model. It indicates that it does not make much of a difference which recorded data is used for the development of tangent speed model.

The obtained results of models are very good, especially in comparison with the models developed on spot speed data measured by a laser gun. Thus, it can be concluded that the method of measurement has a more significant impact on the quality of tangent speed prediction than the location of measurement. That is, the spot speed data collected by a radar gun or a similar device could be biased by the cosine error, drivers changing their behaviour in the presence of test equipment and the human error when reading data from the device display. Therefore, the continuous speed profile of drivers of different sex, age and experience driving their own cars represents the most reliable basis for developing tangent speed models. On the other hand, the continuous speed measurement is harder to carry out because of the need for a high number of test drivers which have to be properly chosen in order to represent the entire population in the sense of sex, age, driving experience and vehicle types. This study shows that continuous speed data can be used to develop a reliable model for prediction of operating speeds on tangents sections of various lengths, from short tangents in which vehicles face insufficient length to reach high speeds (so called non-independent tangents), to long independent tangents which permit vehicles to accelerate up to free-flow operating speeds.

## 5 Conclusions

This paper presents operating speed models on tangent sections based on the collected continuous speed data measured by a 10 Hz GPS device. Unlike spot speed methodologies, continuous speed data allows determination of the locations and unbiased values of the relevant operating speeds on tangents. Most previous speed models were based on the assumption that drivers reach their highest speeds in the middle of tangents. The continuous data collected in this study showed that these assumptions are not realistic. The locations of highest speeds on tangents differ from driver to driver and depend on the geometric characteristics of the preceding and the following elements of horizontal alignment.

However, the developed speed models showed that there is no significant difference in model parameters and coefficients of determination when the maximum speeds on tangents, or when the speeds in the middle tangents were used. Thus, it can be concluded that the method of measurement has a more significant impact on the quality of the tangent speed prediction than the location of measurement. That is, the spot speeds measured by a radar gun or a similar device has shortcomings such as the cosine error, drivers changing their behaviour in the presence of test equipment and human error when reading data from the device display, none of which is the case with the data from the continuous speed profile.

The developed operating speed models on tangents resulted in a high level of reliability. The advantage of the developed tangent speed model in comparison with other developed models is in that it can predict speeds on short and long tangents very reliably. These speeds can be used for evaluation of road design consistency. Another advantage is in that the developed models are based on the continuous speeds measured under true driving conditions for drivers of different age, aggressiveness and driving experience, driving their own cars of different type and age.

## References

- [1] Abdel-Aty, M.A., Radwan, A.E.: Modeling traffic accident occurrence and involvement. *Accident Analysis & Prevention* 32(5), 633-642. DOI:10.1016/S0001-4575(99)00094-9,2000.
- [2] Hassan, Y.: Highway Design Consistency – Refining the State of Knowledge and Practice. *Transportation Research Record* 1881, 2004. Transportation research Board, National Research Council, Washington DC, pp. 63-71. doi: 10.3141/1881-08.
- [3] Polus, A., Matter-Habib, C.: New Consistency Model for Rural Highways and Its Relationship to Safety. *J. Transp. Eng.*, 2004., pp. 286-293, doi: 10.1061/(ASCE)0733-947X(2004)130:3(286).
- [4] Ikeda, T., Mori, N.: Analysis of correlation between roadway alignment and traffic accidents. *Third International Symposium on Highway Geometric Design 2005.*, TRB's Conference Recording series, pp. 69-88.
- [5] Haynes, R., Lake, I., Kinghamb, S., Sabel, C., Pearce, J., Barnett, R.: The influence of road curvature on fatal crashes in New Zealand. *Accident Analysis and Prevention*, 40(3), 2008, pp. 843–850. doi:10.1016/j.aap.2007.09.013.
- [6] Cafiso, S., Di Graziano, A., Di Silvestro, G., La Cava, G., Persaud, B.: Development of comprehensive accident models for two-lane rural highways using exposure, geometry, consistency and context variables. *Accident Analysis & Prevention*, 42(4), pp. 1072-1079. Doi :10.1016/j.aap.2009.12.015, 2010.
- [7] De Luca, M., Dell'Acqua, G.: Freeway Safety Management: Case Studies in Italy, *Transport* 27(3) 2012., pp. 320-326. <http://dx.doi.org/10.3846/16484142.2012.724447>
- [8] Misaghi, P., Hassan, Y.: Modeling operating speed and speed differential on two lane rural roads. *J. of Transp. Eng.*, 2005, pp. 408-418, doi: 10.1061/(ASCE)0733-947X(2005)131:6(408).
- [9] Modeling Operating Speed: Synthesis Report. *Transportation Research Circular number E-C151*, Transportation Research Board, 2011.
- [10] Cafiso, S., Cerni, G.: New approach to defining continuous speed profile models for two-lane rural roads. *Transportation Research Record* 2309, Transportation research Board, National Research Council, Washington DC, pp. 157-167. doi:10.3141/2309-16, 2012.
- [11] Polus, A., Fitzpatrick, K., Fambro, D.B.: Predicting operating speed on tangent sections of two lane rural highways. *Transportation Research Record* 1737, 2000. Transportation research Board, National Research Council, Washington DC, pp. 50-57, doi: 10.3141/1737-07.
- [12] Bonneson, J.A.: Side Friction and Speed as Controls for Horizontal Curve Design. *J. Transp. Eng.*, pp. 473-480, doi: 10.1061/(ASCE)0733-947X(1999)125:6(473).
- [13] Ottesen, J., Krammes, R.A.: Speed-Profile Model for a Design Consistency Evaluation Procedure in the United States. *Transportation Research Record* 1701, 2000. Transportation research Board, National Research Council, Washington DC, pp. 76-85, doi: 10.3141/1701-10.
- [14] Fitzpatrick, K. et al.: Design Speed, Operating Speed, and Posted Speed Practices. NCHRP, report 504, 2003.
- [15] Wang, J.: Operating Speed Models for Low Speed Urban Environments Based on In-Vehicle GPS Data, Dissertation, Georgia Institute of Technology, 183 p., 2006.
- [16] Pérez Zuriaga, A.M.: Characterisation and Modelling of Operating Speed on Conventional Roads Using Naturalistic Observation of Light Vehicles. *Universitat Politècnica de València*, Department of Transport Infrastructure and Engineering, doctoral thesis, 2012.
- [17] Said, D., Hassan, Y., Abd El Halim, A.O.: Comfort thresholds for horizontal curve design. *Canadian Journal of Civil Engineering*, Volume 36, Number 9, 2009, pp.1391-1402, doi: 1391-1402, 10.1139/L09-075.



## SAFETY AT LEVEL CROSSINGS: COMPARATIVE ANALYSIS

Martin Starčević, Danijela Barić, Hrvoje Pilko

*University of Zagreb, Faculty of Transport and Traffic Sciences, Croatia*

### Abstract

From the safety point of view, level crossings (LCs) are critical points in the safe conduct of rail and road traffic. Due to the different characteristics of rail and road vehicles (size, speed, stopping distance, maneuvering capabilities etc.) level crossings are often places with frequent accidents which and in most cases result in human fatalities and big material damages, even though, all of them are secured with appropriate level of technical protection. Accident statistics have shown that the main cause for all accidents (more than 95%) is human factor of road users (drivers, cyclist and pedestrians) who didn't follow and obey traffic safety regulation at level crossings. This review paper presents current safety situation at level crossings in the Republic of Croatia and comparison with EU countries. Safety measures for preventing or diminishing level crossing accidents are presented and proposed.

*Keywords: level crossings, safety, comparison analysis, safety measures*

### 1 Introduction

Level crossings (LC) are places where roads cross railway lines or industrial tracks, i.e. from the aspect of construction, a place of crossing of the carriageway and the running surface of the rail [1]. Because of that, level crossings represent critical point of safety for both road and rail users. General perception in public is that the accidents at level crossings are primarily a railway sector problem, but statistical analysis of accidents show that the main cause of all accidents is human factor of road users (motor vehicle drivers, cyclist and pedestrians) [2,3]. According to [4] fatalities at level crossing accidents represent almost 30% of all fatalities in railway traffic, but only about 1% of fatalities in road traffic. Due to this fact, accidents at level crossings don't represent a significant issue for road sector authorities, but they are mayor obstacles for both traffic efficiency as well as rail safety [5].

In general, studies regarding level crossings safety can be divided into three categories: technical solutions, national and international safety programs and educational campaigns [6]. According to [7] the most important approach for increasing level crossings safety is 5E – Enabling, Education, Engineering, Enforcement and Evaluation, in which is of equal importance cooperation between road and railway sector, continuous education of road users, new technical solutions for level crossing protection systems and evaluation of effectiveness of implemented safety measures.

Since behavior of road users is the main cause for accidents at level crossings, most solutions are based on technical ways to prevent road users to intentionally or unintentionally break traffic rules. Some authors [8] suggest advanced scanning and road vehicle license plates recognition systems. Other authors [9, 10] would like to implement intelligent surveillance systems which will simultaneously give real time information to both train operator and road user. In Japan authors [11] are using obstacle laser detection systems during closed level crossing after which information is than transmitted in real time to train operators. In order to decrease road vehicles approaching speed, some authors [12, 13] suggest implementation of

reflective signs built in road pavement, rumble strips, in-car warning systems and LCD panels that will have information about consequences for illegal behavior.

Even the most technically advanced protection systems will not suffice if the road users don't obey or don't know the proper traffic rules. For that reason national programs and educational campaigns such as Operation Lifesaver in USA [14] and ILCAD – International Level Crossing Awareness Day [15] are trying to increase road user awareness on level crossing dangers by conducting educational lectures and workshops, round tables, creating multimedia games, posting educational posters and influencing social media. In 2000 Croatian railways started educational campaign “Vlak je uvijek brži” [16] in elementary schools, which included lectures, educational posters and pamphlets. This campaign is still active and it is expended on social networks as well.

Aim of this paper is to analyze all relevant statistical data regarding level crossing accidents in Republic of Croatia and compare it with the accident statistics of the all EU countries. The data was collected through comprehensive search of available literature and national safety reports. General classification of level crossings protection systems will be explained first, after which analysis of level crossing safety in Republic of Croatia will be shown. This data will be compared with statistics of all EU countries and appropriate measures will be suggested for improving level crossing safety.

## 2 Level crossings safety in the Republic of Croatia

Basic classification of protecting the level crossings is divided between passive and active protection. Passive protected level crossings are all those crossings which are equipped with any sign of warning, devices or any other protection equipment that is constant and that does not change depending on any traffic situation and where road users [17]. In the Republic of Croatia level crossings passive protection is considered to be the use of road traffic signs “St. Andrews Cross” and “Stop” together with the regulated visibility triangle.

Level crossing active protection is considered to be any type of protection which changes its state (sound, light or mechanical) according to the approaching train. In the Republic of Croatian most common automatic level crossings protection is use of flashing lights and sound traffic signs and use of half-barriers with the sound and flashing lights. In some places there are still level crossings which are protected with full barriers that are controlled manually by dedicated gate keeper.

The total length of railway lines in Croatia is 2.605 km, out of which 2.351 km are single track lines and 254 are double track lines. There are 980 km of electrified lines (977 km with 25kV/50 Hz A.C. system and 3km with 3kV D.C. system) [18].

Every level crossing in Republic of Croatia is protected with a minimum passive protection and out of total 1.520 level crossings, 62,76% are protected with passive protection systems and remaining 37,24% with active protection systems as shown in Table 1. [19].

**Table 1** Classification and number of level crossings in the Republic of Croatia [19]

Passive LC		Active LC				Total
Traffic signs + visibility triangle	Pedestrian crossings	Pedestrian crossings with sound and flashing lights warning	Manual full barriers	Sound and flashing lights with half-barrier	Sound and flashing lights	
895	59	11	65	349	141	1.520
58,88%	3,88%	0,72%	4,27%	22,97%	9,28%	100%

Data analyzed for the last 5 years shows that in 2014 there were total of 37 level crossing accidents in Croatia, which is a 9,75% drop in comparison with the 5 year average, as shown in Table 2. [19].



By analyzing accidents according to type of LC's protection, it can be concluded that in the 5 year period 40% of all accidents happened on actively protected level crossings which is very concerning and shows poor traffic culture in the Republic of Croatia. Detailed analysis of all accidents according to protection level can be seen in Table 2, [19].

**Table 2** Level crossing accidents in the Republic of Croatia by level protection type [19]

Type of LC / Number of accidents	Year				
	2010	2011	2012	2013	2014
Active LC	12	21	21	16	12
Passive LC	29	24	24	20	24
Pedestrian LC	0	1	0	0	1
<b>TOTAL</b>	<b>41</b>	<b>46</b>	<b>45</b>	<b>36</b>	<b>37</b>

Fatalities of level crossing accidents in the Republic of Croatia for the period 2010–2014 are shown in Table 3. In 2014 there were 7 fatalities which is a 27% drop comparing with the 5 year average of 9,6 fatalities, but overall that number oscillates from year to year in observed period.

**Table 3** Level crossing fatalities by level protection type [19]

Type of LC / Number of fatalities	Year				
	2010	2011	2012	2013	2014
Active LC	1	10	3	7	1
Passive LC	6	4	5	4	5
Pedestrian LC	0	1	0	0	1
<b>TOTAL FATALITIES</b>	<b>7</b>	<b>15</b>	<b>8</b>	<b>11</b>	<b>7</b>

Almost all fatalities are road traffic users because they didn't obey clearly visible road traffic signs and level crossings protection systems. As mentioned before, number of fatalities on level crossings is not of primary concern for the road sector due to a fact that the number of accidents and fatalities at level crossings represent just a small fraction of all road traffic accidents and fatalities in the Republic of Croatia, even though the main accident causes at level crossings are road traffic users. Table 4. shows the comparison between the overall number of accidents and fatalities in road sector and at level crossings for the last two years of available data [20].

**Table 4** Comparison of accidents and fatalities of road traffic and level crossings in the Republic of Croatia [20]

Number of accidents / fatalities	Year			
	2013	2014	2013	2014
	Accidents		Fatalities	
Overall road traffic accidents	34.021	31.432	368	308
Level crossing accidents	36	37	11	7

Analyzing the Table 4. it is obvious why the level crossings accidents are not of primary concern for road sector because in the years 2013 and 2014 number of accidents at level crossings represent only 0,11% and 0,12% respectively, out of all the road traffic accident in republic of Croatia. Also the number of fatalities at level crossings represent only 2,98% and 2,27% respectively, for the years 2013 and 2014.

One of the key safety indicators is also the number of broken or damaged half barriers at actively protected level crossings when road vehicles run into them. Since the breakage of



the barriers happens while they are being lowered down or are completely in the final position, meaning at the time of approaching train, every such incident could lead to a potential accident with serious consequences. Table 5. shows the number of broken or damaged half-barriers in period from 2010-2014 [19]. Overall number of broken or damaged barriers is continually decreasing over the last 5 years, with 12,8% drop in the last year comparing with the 5 year average.

**Table 5** Broken barriers in the Republic of Croatia [19]

Year	2010	2011	2012	2013	2014
Broken half-barriers	613	567	522	518	469

Number of broken or damaged half-barriers only partially shows the real situation due to a fact that only heavily damaged half-barriers are reported and also due to a large number of drivers who are intentionally driving around already lowered half-barriers.

### 3 Comparative analysis with EU countries

There are 114.120 level crossings in EU countries (excluding Malta and Cyprus) covering a total of 218.104 kilometers of railway tracks. [21]. A little more than half of all the level crossings have passive systems of protection (51%) and the rest have active protection systems [22], as it is shown in Fig.1.



**Figure 1** Breakdown of level crossings according to type [22].

Comparing just level of protection systems it can be observed that Croatia is a way behind the EU average when it comes to number of actively protected level crossings (37% in Croatia compared with EU average of 49%). Further analysis of all railway traffic accident statistics (Table 6.) shows poor level crossing safety standards in the Republic of Croatia in comparison with all EU countries.

It can be observed from Table 6. that the ratio of level crossing accident in all railway accidents is considerably higher in Croatia comparing with the all of the EU countries. As a 5 year average 37,9% of all railway related accidents in Croatia happened on level crossings while in EU it is considerably lower at 27,5%.

Also, one of the most important indicators of railway safety when it comes to level crossings is number of fatalities at level crossings as a ratio of all railway related fatalities, excluding suicides. Breakdown of all fatalities for Croatia and EU is shown in Table 7.

Unfortunately, it can be observed from Table 7. that the number of fatalities at level crossing accidents as a ratio of all railway related fatalities is considerably higher than for the EU countries. Average 5 year ratio for EU is 29,1% while in Croatia level crossings fatalities represents 44,5% of all railway related fatalities.

**Table 6** Breakdown of railway accidents [22, 26 ]

Number of accidents / LC ratio	REPUBLIC OF CROATIA				
	Year				
	2010	2011	2012	2013	2014
LC accidents	41	44	45	36	37
Total railway accidents	118	99	105	110	105
<b>LC ratio</b>	<b>34,7%</b>	<b>44,4%</b>	<b>42,9%</b>	<b>32,7%</b>	<b>35,2%</b>

Number of accidents / LC ratio	EUROPEAN UNION				
	Year				
	2010	2011	2012	2013	2014
LC accidents	842	736	635	555	542
Total railway accidents	2.789	2.718	2.178	2.103	2.203
<b>LC ratio</b>	<b>30,2%</b>	<b>27,1%</b>	<b>29,2 %</b>	<b>26,4 %</b>	<b>24,6%</b>

**Table 7** Breakdown of railway related fatalities [19, 23]

Number of fatalities / LC ratio	REPUBLIC OF CROATIA				
	Year				
	2010	2011	2012	2013	2014
LC fatalities	7	15	8	11	7
Total railway fatalities	27	26	18	19	19
<b>LC ratio</b>	<b>25,9%</b>	<b>57,7%</b>	<b>44,4 %</b>	<b>57,9 %</b>	<b>36,8 %</b>

Number of fatalities / LC ratio	EUROPEAN UNION				
	Year				
	2010	2011	2012	2013	2014
LC fatalities	385	332	396	315	294
Total railway fatalities	1.312	1.263	1.173	1.168	996
<b>LC ratio</b>	<b>29,3%</b>	<b>26,3%</b>	<b>33,8 %</b>	<b>26,9 %</b>	<b>29,5 %</b>

## 4 Safety measures for increasing level crossings safety

There is no one single measure for increasing safety at level crossings. The only efficient solution is to completely separate railway and road traffic in two levels by building overpasses or underpasses. But unfortunately high costs of such projects will prevent this kind of solution on all but the level crossings with the highest traffic volume or dangerous accident history. Therefore, it is necessary to find more immediate and cost effective solutions that can be implemented rather fast and it is appropriate for every level crossing, regardless of their protection level. However, even the most advanced protection systems will not suffice if the users don't obey or don't understand traffic rules regarding level crossings. In order to achieve that, there should be more emphasis on educating users on level crossing dangers. First step to achieve this goal is to widen curriculum in driving schools so that young drivers will be more prepared for level crossing dangers. Also, there should be a continuous national campaign throughout media and social networks with ads and posters explaining the dangers

and consequences of illegal behavior on level crossings. Furthermore, big poster panels with the same information could be installed in the close vicinity of level crossings with higher traffic volume and/or accident history. Since in Croatia there are 62,76% passive protected level crossings, one of the first technical measures should be regular maintenance of visibility triangle especially in times of increased vegetation growth (spring, summer), since this can severely diminished the visibility from road to railway tracks. Since the visibility triangle is calculated from the position of road traffic signs “Stop” and “St. Andrew’s Cross”, the position of these traffic signs on all passive protected level crossings should be moved to the maximum possible [24] allowed distance from the nearest railway track which is 3 meters. Reason for that is in increased visibility from road to railway track and thus better view on approaching train. Current situation of position of these traffic signs on passive protected level crossings in Croatia varies significantly from 3 meters up to 10 meters from the nearest railway track [25] so it is necessary to enforce this measure in order for the drivers to have better view of railway tracks and approaching train. This task should be responsibility of local road authorities in the area where the level crossing is located. On actively protected level crossings with half-barrier road vehicle drivers are intentionally disregarding traffic rules by driving around lowered half-barriers, which presents significant safety issue. Cost effective solution for this problem would be installation of median barriers for providing separation of directional traffic on the approaches to railway level. They are installed on the road centerline leading right next to lowered half-barrier so that it is impossible for drivers to go around the barriers once they are lowered down. The length of such separators should be at least 10 meters from the barriers, but it could be longer, depending on the local circumstances [26]. Since there are only 349 level crossings with half-barriers in the Republic of Croatia, this cost effective solution should be implemented nationwide on all of them.

## 5 Conclusion

Railway traffic is one of the safest transportation modes but it is concerning fact that accidents at level crossings are a significant safety issue worldwide as in Croatia. In 2014 there were 37 level crossing accidents in Croatia which is 9,75% drop comparing with the 5 year average (2010-2014). What is concerning that in the same period 40% of all LC accidents happened on level crossings with active protection. Number of fatalities on level crossing accidents in Croatia in 2014 is 27% lower than the 5 year average but overall it oscillates from year to year. Further analysis in the Republic of Croatia in 5 year period (2010-2014), shows that 37,9% of all railway related accidents (excluding suicides), as a 5 year average, happened on level crossings. That is a demeaning fact when comparing with EU average for the same period of 27,5% of level crossing accidents. Comparing level crossing fatalities as a ratio of all railway related fatalities in the same period (2010-2014) Croatia’s 5 year average is very high at 44,5% fatalities at level crossings. Average for the same 5 year period for the whole EU is considerably lower at 29,5%. This comparison shows poor traffic culture in the Republic of Croatia and it is very concerning from safety point of view.

Since the main cause of all level crossings accidents is human behavior of road users (motor vehicle drivers, cyclist and pedestrians) [2,3], every implemented measure for increasing safety at level crossings should be designed so they can maximally possible remove bad human decisions while driving or walking over level crossings. So, the only effective solution is building overpasses or underpasses, but high cost of such projects brings a need for more cost effective solutions, like proposed median barriers and increasing visibility triangle.

Unfortunately, technical solutions are only effective if the road users completely obey traffic rules regarding level crossings. Because of this fact and also accident history on level crossings in Republic of Croatia, it is equally important to systematically implement educational campaign for all level crossing users together with increased repression policies. Currently, the only educational campaign in the Republic of Croatia is conducted by “HŽ Infrastruktura”

in form of periodical lectures in elementary schools and handing out educational pamphlets to drivers on selected level crossings. This is a well thought campaign, but because of the budget constraints it is small in scale considering the current level crossing safety in Croatia, and it should be expanded to high schools and driving schools and also be a part of a national strategy for increasing safety at level crossings.

## References

- [1] Toš, Z.: Signalizacija u željezničkom prometu (Signalisation in Railway Traffic), University of Zagreb, Faculty of Traffic and Transport Sciences, Zagreb, 2013.
- [2] Starčević, M., Barić, D., Hozjan, D.: Safety analysis at level crossings, the 12th Scientific conference, ZIRP 2014: DEVELOPMENT POSSIBILITIES OF CROATIAN TRANSPORT SYSTEM – ANNIVERSARY OF EU MEMBERSHIP, Proceedings, pp. 77-85, Zagreb, April 15th, 2014
- [3] Pilko, H., Barić, D., Hozjan, D.: Analysis of pedestrian and cyclist behaviour at level crossings, 3rd International Conference on Road and Rail Infrastructure CETRA2014, Proceedings, pp. 969-976, Split, 28-30 April, 2014
- [4] D1- Report about Statistics, Database Analysis and Regulations for Level Crossing, SELCAT, International Union of Railways (UIC), Paris, France, September 2008
- [5] Silla, A., Luoma, J.: Opinions on Railway Trespassing of People Living Close to a Railway Line. Safety Science, 50(1), pp. 62–67, 2012.
- [6] Badanjak, D., Barić, D., Novačko, L: Priority measures of improving level crossings safety, 11th International Conference on Transport Science, Proceedings, pp. 11-20, Portorož, Slovenia, 28- 29 May, 2008
- [7] Nelson, A.: Level Crossings: The-state-of-the-art, 12th Global Level Crossing and Trespass Symposium, Proceedings, p.15, London, UK, 8-10 October, 2012
- [8] Cho, B. K, Ryu, S. H, Shin, D. R., Jung, J. I.: License Plate Extraction Method for Identification of Vehicle Violations at Railway Level Crossing, International Journal of Automotive Technology, Korean Society of Automotive Engineers (KSAE), Seoul, Korea, Vol. 12, No. 2, pp. 281-289, 2011
- [9] Cho, B., Jung, J.: A Study on Intelligent Railway Level Crossing System for Accident Prevention, IJR International Journal of Railway, The Korean Society for Railway (KSR), Seoul, Korea, Vol. 3, No. 3, pp. 106-112, September, 2012
- [10] Singh, J., Desai, A., Acker, F., Ding, S., Prakasamul, S., Rachide, A., Bently, K., Nelson-Furnell, P.: Cooperative Intelligent Transport Systems to Improve Safety at Level Crossings, 11th Level Crossing Symposium, Proceedings, 16 p., Tokyo, Japan, 26-29 October, 2010
- [11] Hiraguri, S., Sato, K.: Current Status of Level Crossing Accidents and Solutions for Enhancing its Safety in Japan, 10th World Symposium on Safety at the Road/Rail Interface, Proceedings, 35 p., Paris, France, 24-27 June, 2008
- [12] Cale, H.M., Gellert, A., Kats, N.: Evidence Based Planning or How to Prevent Crashes at Rail Crossings: A new Metodology, 12th Global Level Crossing and Trespass Symposium, Proceedings, 17 p., London, UK, 8-10 October, 2012
- [13] Tey, L.-S.: Evaluating Driver Behavior Toward Innovative Warning Devices at Railway Level Crossings Using a Driving Simulator. Journal of Transportation Safety & Security, 5(2), pp. 118–130, 2013
- [14] Sramek, H. M.: Operation Lifesaver USA: Transforming for the Digital Ege, 12th Global Level Crossing and Trespass Symposium, Proceedings, 6 p., London, UK, 8-10 October, 2012
- [15] Fonverne, I.: ILCAD, International Level Crossing Awareness Day, 12th Global Level Crossing and Trespass Symposium, Proceedings, 8 p., London, UK, 8-10 October, 2012
- [16] <http://www.hzinfra.hr/akcija-vlak-je-uvijek-brzi> (Accessed March 2016)
- [17] Sever, D.: New Approach to Determining Visibility Length on Passive Protected Level Railroad Crossings, University of Zagreb, Faculty of Transport and Traffic Sciences, Zagreb, Croatia, Promet – Traffic&Transportation, Vol. 24, No.6, pp. 479-486, 2012

- [18] Izvješće o mreži 2015 ( Network Statement 2015), HŽ Infrastructure Limited Liability Company for Management, Maintenance and Building of Railway Infrastructure, Zagreb, Croatia, 2015
- [19] Godišnje izvješće o sigurnosti u 2014. godini (Yearly Safety Report 2014), HŽ Infrastructure Limited Liability Company for Management, Maintenance and Building of Railway Infrastructure, Zagreb, Croatia, 2015
- [20] Statistički pregled temeljnih sigurnosnih pokazatelja i rezultata rada u 2014. godini (Statistical Review of Basic Safety Indicators and Work Results in 2014), Republic of Croatia, Ministry of the Interior, Zagreb, Croatia, January, 2015
- [21] Lowest death toll recorded on EU railways since 2006, but collisions and derailments on rise in 2012, Press release , European Railway Agency, Valenciennes, France, October 21<sup>st</sup>, 2013
- [22] Railway Safety Performance in the European Union, European Railway Agency, Valenciennes, France, May 25th. 2014
- [23] <http://ec.europa.eu/eurostat/data/database> (Accessed February, 2016.)
- [24] Pravilnik o prometnim znakovima, signalizaciji i opremi na cestama, NN 64/2005, Zagreb, Croatia, 2005
- [25] Sveučilišni projekt: Istraživanje mjera povećanja sigurnosti na željezničko-cestovnim prijelazima, Sveučilište u Zagrebu, Fakultet prometnih znanosti, Zagreb, 2013.
- [26] Starčević, M.: Level Crossings Risk Assessment Model, doctoral thesis, University of Zagreb, 2015



## PROBLEMS OF CROSSFALL CHANGEOVER FOR REVERSED CROSSFALLS

Ivan Lovrić, Boris Čutura, Danijela Maslač

*University of Mostar, Faculty of Civil Engineering, Bosnia and Herzegovina*

### Abstract

Crossfall of the carriageway is generally oriented to one side and changing is implemented in principle over the entire length of the transition curve. In the case where crossfalls are reversed, this changeover section is potentially dangerous for aquaplaning (safety problem especially for high speeds). The main parameter for this analysis, relative grade  $\Delta s$  [%], is the difference between the longitudinal gradient along the edge of the carriageway and the longitudinal gradient along the axis of rotation ( $\Delta s \geq \Delta s_{\min}$ ). Guidelines and regulations of different countries offer some standard solutions for design of these critical zones, but there are also some differences and special solutions (wedge-like crossfall changing – inclined superelevation). This paper shows the analysis of Bosnian and Herzegovinian, Croatian, Serbian, Austrian, German, Swiss and TEM guidelines.

*Keywords: crossfall changeover, relative grade of the edge, aquaplaning, wedge-like crossfall changing*

### 1 Introduction

Presence of water on the carriageway surface causes a very high number of traffic accidents. For that reason, carriageways on straights are designed with a one-sided crossfall  $q$  of at least 2.5 % to the outside. For reasons of vehicle dynamics, circular curves are generally designed with a crossfall towards the inside of the circular curve.

The crossfall of a carriageway is changed over a road section known as the superelevation development section. The superelevation development (or rotation of the pavement) generally takes place within the transition curve, regardless of the axis around which the roadway is rotated (Figure 1).

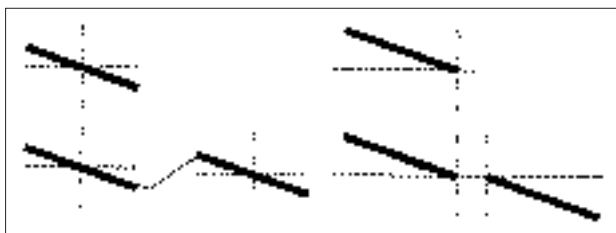


Figure 1 Types of superelevation development [1]

For high driving speeds even a low water film thickness is potentially dangerous for aquaplaning. This problem is especially evident in the zones where crossfalls are reversed and even more for low grades.

For these reasons it is necessary to provide sufficient longitudinal grade of the road (vertical alignment) and ramp of superelevation development. These problems are most pronounced at high speeds and therefore the focus continues to be on them (Motorways with speed  $V \geq 120$  km/h).

## 2 Problem of crossfall changeover

The basic parameters that must be ensured for a superelevation development section are vehicle dynamics and drainage conditions, and these parameters are in conflict.

The main parameter for this analysis, relative grade  $\Delta s$  [%], is the difference between the longitudinal gradient along the edge of the carriageway and the longitudinal gradient along the axis of rotation. In Swiss guidelines its symbol is  $i$  and in Serbian  $i_{RV}$  (in others also  $\Delta s$ ). It is calculated as follows [1]:

$$\Delta s = \frac{q_1 - q_2}{L_v} \cdot a \quad (1)$$

Where:

- $q_1$  [%] – crossfall at the end of the superelevation development section,
- $q_2$  [%] – crossfall at the start of the superelevation development section,
- $L_v$  [m] – superelevation development length,
- $a$  [m] – distance between the edge of the carriageway and the rotation axis.

To ensure the drainage and vehicle dynamics conditions,  $\Delta s$  should be:

$$\Delta s_{\min} \leq \Delta s \leq \Delta s_{\max} \quad (2)$$

The minimum value for drainage is as follows:

$$\Delta s_{\min} = k_v \cdot a \quad (3)$$

Where:

- $k_v$  [%/m] – coefficient of the superelevation development that provides drainage.

The maximum value (vehicle dynamics condition)  $\Delta s_{\max}$  depends on the design speed. A sufficient longitudinal grade of the vertical axis should also be provided, taking into account the requirements of superelevation development. Low longitudinal grades in this section are problematic due to slow runoff (Figure 2). The problem is also on vertical curves if this zone is in the vicinity of curve crown.

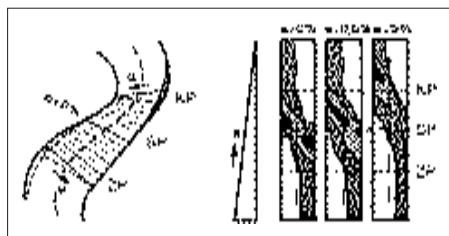


Figure 2 The influence of slope on runoff [3]

In the case where the crossfalls are reversed, minimal longitudinal grade of vertical axis is usually [1], [2]:

$$i_{\min} = \Delta s + 0.3\% \quad (4)$$

In cases of low longitudinal grade, some guidelines give “a special” solution as inclined superelevation shown in Figure 3.

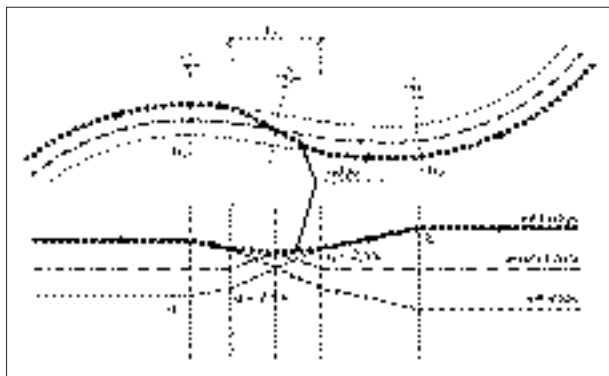


Figure 3 Inclined superelevation [1]

### 3 Crossfall changeover according to different guidelines

The above mentioned problem of superelevation development is most evident at high speeds. A minimum and maximum value of relative grade  $\Delta s$  are very close and at the same time there is a conflict between vehicle dynamics and drainage problem. Also, there is a problem for low longitudinal grade of vertical axis. Different guidelines offer some standard solutions for design, but there are also some differences and special solutions (wedge-like crossfall changing, inclined superelevation). This chapter shows the analysis in Bosnian and Herzegovinian, Croatian, Serbian, Austrian, German, Swiss and TEM guidelines.

#### 3.1 The minimum relative grade $\Delta s_{\min}$ – drainage condition

According to the above-mentioned guidelines and equation (3), the minimum value for drainage is  $\Delta s_{\min} = k_v \cdot a$ . This coefficient  $k_v$  is 0.1 in all guidelines. Only Bosnian and Herzegovinian guidelines [1] give a possibility of  $k_v = 0.06$  (even 0.03), “because the value 0.1 causes “flapping” of the carriageway and special design measures shall be provided in this area”. For the case where  $\Delta s < \Delta s_{\min}$ , there are the basic principles of polygonal ramps. This critical zone for aquaplaning has the relative grade  $\Delta s_{\min}$  up to the crossfall of 2.5 %, and second ramp grade is not essential. These principles are the same in all the guidelines (shown in Figure 4.).

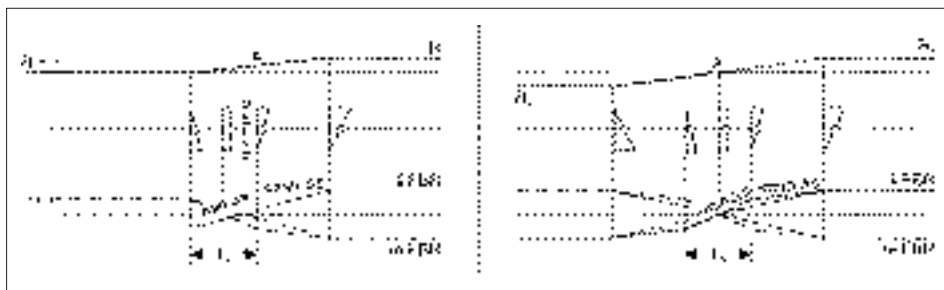


Figure 4 Principles of ramps design [7].



### 3.2 The maximum relative grade $\Delta s_{\max}$ – driving dynamics and aesthetics conditions

There are different values for maximum relative grade  $\Delta s_{\max}$  (shown in Table 1).

**Table 1** Values of maximum relative grade  $\Delta s_{\max}$

Guidelines	V (km/h)			
	80	90	100	>100
BiH [1] (n=num. of lanes)	$1.05 \cdot n$	$0.75 \cdot n$	$0.50 \cdot n$	$0.40 \cdot n$
Croatian [2]	1.00	1.00	0.80	0.80
Serbian [3]	1.00	1.00	0.90	0.90
Austrian [4]	–	–	–	–
German [7]	1.00	1.00	0.90	0.90
Swiss [8]	0.75	0.75	0.75	0.75

Austrian guidelines do not give explicit values. Values of  $\Delta s_{\max}$  and  $\Delta s_{\min}$  are very close for high speeds (same for the highest).

## 4 Special design measures – Inclined superelevation

As discussed in Chapter 2, there is a problem of slow runoff water from the road surface in the area of small crossfall, especially in combination with small longitudinal grade of the roadway (Figure 2). Some guidelines give inclined superelevation, and some do not. Croatian guidelines do not have inclined superelevation, while B&H guidelines provide it only for speeds less than 80 km/h (in practice it is almost unnecessary for these speeds). Other previously mentioned guidelines allow inclined superelevation.

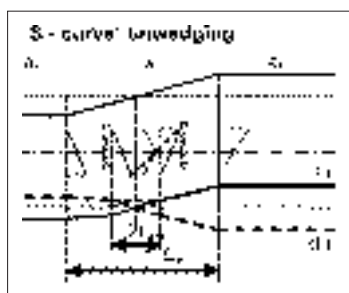
### 4.1 Bosnian and Herzegovinian guidelines

These guidelines allow inclined superelevation for speeds  $V \leq 80$  km/h (Figure 5). The minimum superelevation development length is calculated as follows:

$$L_v = 0.1 \cdot B \cdot V \quad (5)$$

Where:

- $L_v$  [m] – length of inclined superelevation section,
- $B$  [m] – width of the carriageway,
- $V$  [km/h] – conceptual design speed.



**Figure 5** Inclined superelevation in B&H guidelines [1]

## 4.2 Serbian guidelines

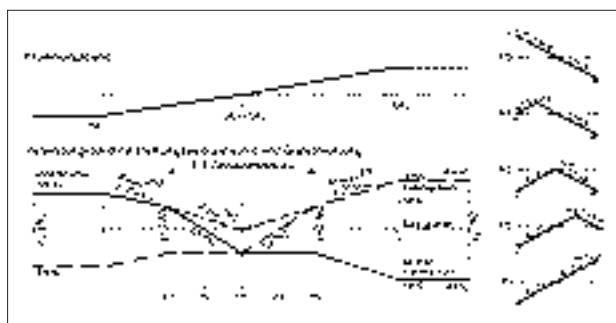
Serbian guidelines have inclined superelevation for all speed and give the minimum length calculation as B&H (5). Minimum lengths of inclined superelevation sections are given in Table 2. The guidelines do not recommend them for speeds  $V > 100$  km/h because of the disjointed slope.

**Table 2** Length of inclined superelevation  $L_k$  section [3]

$V_p$ [km/h]	50	60	70	80	90	90	100	110	120	130
$L_k$ [%]	–	40	50	60	70	80	100	125	135	150

## 4.3 Austrian guidelines

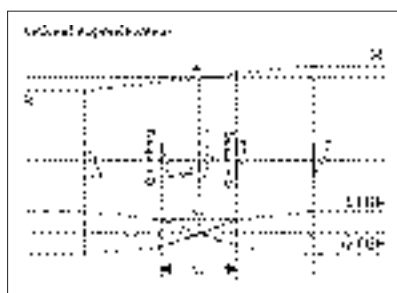
Austrian guidelines allow inclined superelevation for all speed and give the minimum length as  $7 \cdot$  carriageway width (Figure 6).



**Figure 6** Inclined superelevation in Austrian guidelines [4]

## 4.4 German guidelines

The German guidelines for highways RAL [6] do not have inclined superelevation, but it is provided in the guidelines for motorways RAA [7]. The guidelines for motorways include [7] long-distance motorways (EKA 1 A – 130 km/h), inter-regional motorways (EKA 1 B – 120 km/h), motorway-like roads (EKA 2 – 100 km/h) and urban motorways (EKA 3 – 80 km/h). Inclined superelevation is allowed for all of them and its principles and calculation is the same as in B&H guidelines [1].



**Figure 7** Inclined superelevation in German guidelines [7]

## 4.5 Swiss guidelines

Swiss guidelines also include inclined superelevation (Figure 8). Minimum lengths of this section are given for speeds 80, 100 and 120 km/h (Table 3).

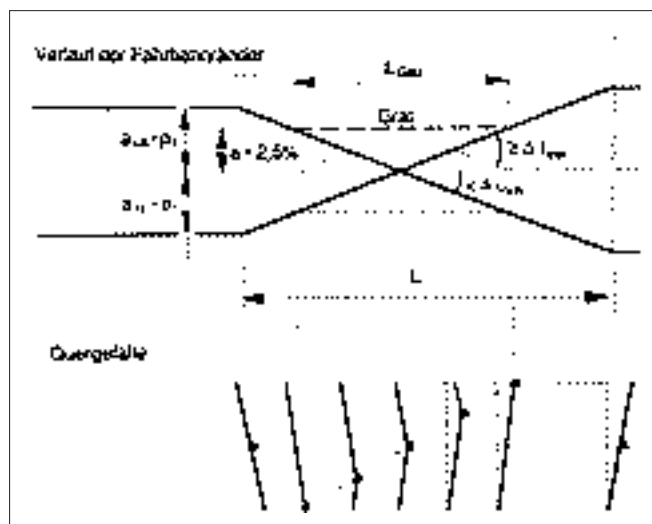


Figure 8 Inclined superelevation in Swiss guidelines [8]

Table 3 Length of inclined superelevation section in Swiss guidelines [8]

$V_p$ [km/h]	120	100	80
$L_{mn}$ (p = 2.5%) [m]	12 B	10 B	8 B

B = Fahrbahnbreite [m]

## 4.6 TEM guidelines

TEM guidelines from 2003 propose as a solution inclined superelevation on straights (Figure 9), but these proposals are not widely accepted.

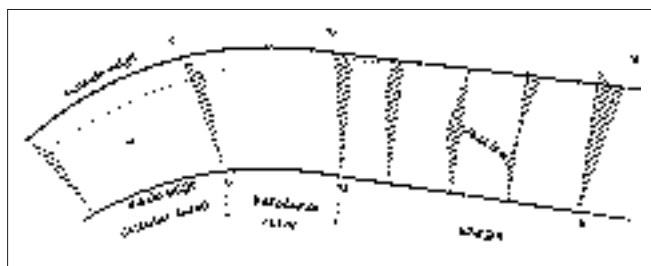


Figure 9 Inclined superelevation on straight, according to TEM standards [9]

## 5 Conclusion

Based on the above it can be concluded:

- 1) The minimum relative grade is  $\Delta s_{\min} = 0.1 \cdot a$ , except in B&H guidelines that allow less  $k_v = 0.06$  (even 0.03). The coefficient  $k_v$  less than 0.1 is not recommended and it is better to leave it out in the guidelines.
- 2) For high speeds the maximum relative grade  $\Delta s_{\max}$  is close or equal to the minimum  $\Delta s_{\min}$ .
- 3) It should be considered to introduce inclined superelevation in B&H and Croatian guidelines (for higher speeds). In some conditions of small longitudinal grades, the problem of drainage is probably more dominant than the potential problems of driving dynamics and aesthetics. Inclined superelevation is already present in many guidelines.

In addition, due to the significant differences between motorways and other classes of highways, it is logical to introduce separate guidelines for motorways and other highways.

## References

- [1] Pravilnik o osnovnim uvjetima koje javne ceste, njihovi elementi i objekti na njima moraju ispunjavati sa aspekta sigurnosti saobraćaja, Sarajevo/Banja Luka 2007.
- [2] Pravilnik o osnovnim uvjetima kojima javne ceste izvan naselja i njihovi elementi i objekti moraju udovoljavati sa stajališta sigurnosti prometa, Zagreb, 2001.
- [3] Priručnik za projektovanje puteva u Republici Srbiji, Beograd 2012.
- [4] Linienführung und Trassierung, Linienführung, RVS 03.03.23., Wien 2014.
- [5] Richtlinien und Vorschriften für den Strassenbau, RVS 3.23., Wien 1997.
- [6] Richtlinien für die Anlage von Landstrassen, RAL, Forschungsgesellschaft für Strassen und Verkehrswesen e.V., Köln 2012.
- [7] Guidelines for the Design of Motorways RAA, Edition 2008 and Translation 2011, Forschungsgesellschaft für Strassen und Verkehrswesen e.V., Köln 2008.
- [8] Vereinigung Schweizerischer Strassenfachmänner (VSS): Linienführung, Quergefällsänderung (SNV 640 140) Zürich, 1991, 2001.
- [9] Tem Standards and recommended Practice, Trans-European North-South Motorway (TEM), Third Edition, Warsaw 2002.





## EFFECTIVE AND COORDINATED ROAD INFRASTRUCTURE SAFETY OPERATIONS: COMMON PROCEDURES FOR JOINT OPERATIONS AT ROADS AND TUNNELS

Marios Miltiadou, Liljana Cela, Mate Gjorgjievski  
*South East Europe Transport Observatory (SEETO), Serbia*

### Abstract

The “Effective and Coordinated Road Infrastructure Safety Operations” (ECORoads) is an on-going project, which is financed by the EU Horizon 2020 Programme. Its general objective is to overcome the barrier emerging from the formal interpretation of the Road Safety and Tunnels Safety Directives that do not allow Road Safety Audits and Inspections (RSA/RSI) to be performed in uniform way along both open roads and tunnels.

The project aims at the definition of an integrated approach for road infrastructure and tunnel safety management, on the basis of the existing legislative framework and the available experience of road and tunnel experts and best practices. This approach comprises the formulation of common rules of procedures for the organization, performance, reporting and evaluation of the joint road safety operations (audit and inspection) at sections consisted of both open roads and tunnels. The approach is tested and validated with pilot safety operations, which are organized at five different test sites Central and Southeast Europe and, at time being, the first two pilot actions were performed, in March and April 2016. This paper presents the ECORoads concept, the developed common approach and the preliminary conclusions from the joint road safety operations performed at Kennedytunnel (Antwerp, Belgium) and at Krrabe tunnel (Tirana – Elbasan highway, Albania), which shall allow the fine-tuning of the procedures for the next set of field tests in Germany (Rennsteig tunnel), Serbia (Belgrade bypass, Strazevica tunnel) and the former Yugoslav Republic of Macedonia (Demir Kapija tunnel) and, at a later stage, the formulation of recommendations for the incorporation of road safety operations into the tunnel safety ones.

*Keywords: road safety, tunnel safety, South East Europe, ECORoads project*

### 1 Introduction

RSA operations during the design process or RSI after opening to traffic, according to the prescriptions of the Directive 2008/96/EC (Road Infrastructure Safety Management – RISM) [1], could be beneficial for risk prevention in tunnels. However, the RISM Directive does not apply in road tunnels, which are covered by Directive 2004/54/EC [2] that mainly focuses on safety issues and risk management in case of incidents more general than road accidents (fire, collisions or car breakdown, etc.).

While from the road users’ point of view the road is a unique linear infrastructure generally in open terrain and sometimes in closed environment (tunnels), the strict application of the two Directives leads to a non-uniform approach to the infrastructure safety management outside and inside tunnels. The ECORoads objective is to experiment on the merging of the road and tunnels safety procedures in one integrated approach for joint road safety operations.

## 2 Methodology

The project comprises Workshops with stakeholders (European tunnel and road managers); exchange of best practices and experiences between tunnel experts and road safety professionals; joint pilot safety operations at five European road sections that feature both open roads and tunnels that have been selected among several candidatures at earlier stage of the project; and, based on their results, formulation of recommendations for the application of the RSA and RSI concepts in tunnel safety operations.

During and after a workshop with stakeholders and a seminar for best practices exchange between road and tunnel experts held in September and November 2015, respectively, the basic principles of the approach for the field tests were set and the aspects regarding the common procedures definition towards the accomplishment of the project's targets were thoroughly discussed. Specifically, issues like the definition of the road sections and tunnel areas to be audited/ inspected; the joint audit/ inspection process; composition, roles and responsibilities of the joint team; tools and methods; coverage of the road users' point of view; reporting, evaluation and monitoring were discussed in detail among the project consortium, stakeholders and experts.

Based on the outcomes of these discussions, available literature and results of previous relevant national and international projects, the common procedures were elaborated [3]. In this aspect, apart from the guidelines of the relevant Directives, several sources and research projects' outputs were identified and have been taken into account, as mentioned in the following chapter that presents the common procedures.

Then, from the experience gained from these field tests, the experts' feedback and the assessment during the 2<sup>nd</sup> project Workshop with stakeholders in June 2016, the common procedures shall be fine-tuned during the second set of field tests foreseen in the period July – October 2016, providing the basis for the formulation of recommendations for joint road and tunnel safety operations.

## 3 Common procedures for the joint road safety operations in roads and tunnels

### 3.1 Planning, organisation, reporting and monitoring the field tests

At each for the ECORoads test sites, a close cooperation and coordination among different partners and stakeholders is a prerequisite for organisational and planning purposes. The involvement of the Infrastructure Managers (IMs) of the test sites should be ensured, and therefore a Facilitator is appointed for each of them to plan the field test, organise the appropriate meetings and site visits, and cooperate and obtain from the IMs the necessary data for the scope of RSA/RSI. Following the definition of the Common Procedures, the Facilitators and the hosts-IMs set out the dates, the programme, the composition of the visiting team (called RSA/RSI Group) and RSA/RSI experts (called RSA/RSI Core Team).

Two meetings are organised: i) a Briefing Meeting, for presenting to the participants the scope and procedures of ECORoads field tests, for presenting details of the project under RSA/RSI to the RSA/RSI Core Team, for provision of clarifications on issues that emerged from the available data and information, and for gathering information and opinions from external experts and stakeholders; and ii) a Completion Meeting, for the RSA/RSI Core Team to present their preliminary findings to the IM and the RSA/RSI Group. The reporting, feedback and monitoring process comprise:

- The RSA/RSI Report that should contain all the road safety problems and deficiencies that have been identified and commented by the RSA/RSI Core Team and delivered to the IM and the other members of the RSA/RSI Group. It should describe the road safety measures and the experts' recommendations/ advice for solutions to alleviate the encountered problems

and that would reduce risks and accidents' numbers or severity in the short-, medium and long-term. This report is delivered within 2-3 weeks' time.

- The feedbacks from all the involved parties (see section 3.2).
- Report on Common Procedures, regarding the conformity of the procedures followed with the Common Procedures, which is delivered by an "Internal Observer", appointed by the consortium to ensure efficient monitoring of the field tests, and to contribute to the fine-tuning of the procedures and the formulation of recommendations.
- Feedback from the IM on the RSA/RSI Report.
- The Final Report, taking into account the response of the IM.

### 3.2 Team composition, roles and responsibilities

The ECORoads field tests require a multidisciplinary and multifunctional team that covers both the needs of a) the RSA/RSI simulation and b) monitoring and assessing the common procedures in order to fine-tune the procedures and conclude solid recommendations for joint operations. Each RSA/RSI is performed by a RSA/RSI Core Team, which is an international team of experts that are assigned to jointly and independently (from the IMs) perform an RSA/RSI at a designated field test and report on their findings. The Core Team is consisted of at least three and preferably four (2 road + 2 tunnel) experts, with a road safety expert as Team Coordinator.

This team is part of a wider RSA/RSI Group, which comprises other experts – from the consortium or not – that are involved in the ECORoads procedure. It is a mixed international team of (road/ tunnel) experts and other stakeholders that take part in a field test. It consists of the RSA/RSI Core Team, the "External" observers, the Facilitator and the ECORoads "Internal" observer, and representative of the host organisation/ IMs:

- Infrastructure (Road/ Tunnel) Managers or State/ Regional Road Authority of an ECORoads field test: co-organises and facilitates the RSA/RSI, provides the necessary information and data and responds to the RSA/RSI Report.
- Facilitator: is a local/ national expert and, as previously mentioned, ensures organisation and communication/ cooperation between the IMs and the project.
- "External" Observers: stakeholders with different competences, representing different authorities that can provide information to the RSA/RSI Core Team (particularities of a test site, seasonal conditions, peak months, raining or hard winter days, etc.).
- Other "External Experts" and Stakeholders: other local and national interested parties (incl. road user groups and associations) providing complementary information to the Core Team, notes and remarks to the RSA/RSI Group before and during the Briefing Meeting.
- ECORoads "Internal" Observer: a member of the ECORoads consortium, who takes part in the field test, ensures the conformity of each joint audit/ inspection with the common procedures and reports to the consortium. He/she mostly ensures the effective monitoring of the proper and homogeneous application of the ECORoads Common Procedures and is responsible to present to a Workshop with Stakeholders intermediate comments/ remarks on the two first field tests and formulate any recommendations for the other field tests.

### 3.3 Common definitions on infrastructure segmentation

The field tests should be performed bi-directionally on adjacent (to the tunnel) open roads, transition areas and tunnel interior, presented in Figure 1. The length of the open road in each field test is defined, taking into account the influence of the tunnel before the transition area of the tunnel and it is defined based on the local conditions and particularities, after receiving information from the IMs and local experts, and taking into account the distance of warning of road users about the existence/ approach to the tunnel (vertical signage and road marking) and the presence of adjacent interchanges, entry/ exit ramps, weaving manoeuvres, etc.





**Figure 1** Segmentation of infrastructure for the ECORoads field tests

The transition area between an open road and a tunnel for the scope of ECORoads project, is defined at least as the sum of a) the distance calculated as the distance covered in 10 seconds by a vehicle travelling at the speed limit before the tunnel portal and b) the stopping distance after the tunnel portal, for a vehicle travelling at speed limit, if not identical with design speed. This minimum rule obviously applies on the opposite direction and also – may be slightly modified due to reduced speed within the tunnel – at the exit of the tunnel and on the same direction. The stopping distance may be calculated using one of the equations proposed by PIARC [4], using the initial vehicle speed and other important factors, i.e. the driver reaction time, the longitudinal friction coefficient or the vehicle deceleration rate, etc. Finally, since part of the tunnel infrastructure is considered as part of the transition areas, the tunnel interior section for this exercise is defined as the remaining part of the infrastructure between the transition areas on both sides of a tunnel.

### 3.4 Data, tools and methods

Generally, the tools and methods to be used in ECORoads exercise (checklists, technical equipment, templates for reporting and evaluation) are those that are implemented according to international and national best practices and recommendations, slightly modified and adjusted to serve the project scope.

#### 3.4.1 Data requirements

The provision of all necessary data is fundamental for the success of the RSA/RSI operations. The required data and documents are explicitly defined for RSI, whilst for RSA vary depending on the project maturity and the RSA level to be carried out, considering that the prepared or on-going (under construction) projects are well advanced in terms of design, as well as that RSA at different road project phases are not always performed by the various countries where the test sites are located. Pictures and video recordings should be also used for preparation purposes, as well as for the preparation of RSI report. The exploitation of such material is encouraged, considering the limited time on site and for ensuring the least exposure of the RSA/RSI Group to traffic during inspections (see section 3.4.3)

#### 3.4.2 Checklists

The use of checklists is recommended, as a mean that ensures a homogeneous approach and assessment of road safety and at the same time the avoidance of failures of noticing all safety problems due to the high expertise and self-confidence of the experts. In that way, the possibility of overlooking some important safety elements due to a more loose approach by the experts, deriving from their expertise on specific aspects, is minimised.

For the scope of the ECORoads exercise, the RSA/RSI checklists proposed by PIARC are adopted as a basis of work, along with the relevant EU Directives' criteria and elements for tunnel safety assessment included in checklists in various countries.

Especially concerning tunnels and transition areas, two checklists were composed, comprising aspects that influence road safety in these sections (e.g. sharp curves of the road alignment near the tunnel, unprotected edges at tunnel portals, use of ordinary road markings

instead of rumble strips), taking into account relevant national RSA/RSI guidelines that include such provisions for RSA/RSI in tunnels [5], [6]. Furthermore, the “Human Factors and Road Tunnel Safety Regarding Users” [7] findings and recommendations are also taken into consideration, as well as RSA training material for safety in tunnels [8], provided that the aspects to be checked in ECORoads should not be all those of the Tunnel Directive, but the main criterion of their inclusion in checklists are oriented to road user’ safety. For transition areas, a combination of aspects from checklists for open roads and the checklists for tunnels is defined and, to avoid duplications, aspects which are profoundly included in transition areas (e.g. portals, drainage, adaptation luminance, etc.) are excluded from checklists for tunnels.

### 3.4.3 Equipment and safety

Given the project particularities that require mobilisation of people from different European countries, the most advanced equipment and practices usage is encouraged during the field tests, ensuring less time-consuming operations and at the same time less exposure of the RSA/RSI Group to traffic. In this aspect, usage of handheld GPS devices and digital cameras and video cameras with geo-tagging potentials that can be easily georeferenced (complementarily with maps and drawings in appropriate scale, the car odometer and/ or car GPS to cover sections with no or low satellite signals) is encouraged. Other equipment, commonly used in such operations (for measurements of distances, speed, cross falls, lighting conditions etc.) could be used, according to the experts’ requirements and details’ needs.

For open roads and open road parts of transition areas, satellite and aerial photos (ortho-rectified) and ortho-photomaps could be also used for in-house work, with appropriate georeference, preferably in WGS84 Datum – that is used by GPS systems – as well as online mapping tools.

Regarding safety during inspections, both for the road users and for the Inspection/ Group, appropriate measures should be taken, in cooperation with the IMs and Traffic Police. The particularity of carrying out inspections on high speed roads and in tunnels requires more radical safety measures, with closures of traffic lanes), which requires appropriate warning signage (road works and directional signs, flashing lights) at specific distance before the closure occurs.

Especially for tunnel inspections it is preferable to carry out the inspection works during the closure of each tunnel tubes for maintenance. In any case, the days and hours of the field tests should be decided according to the project needs, the traffic conditions and the possibilities for infrastructure closure, and thus with a concern to balance project needs with safety requirements. This enhances the need of dedicating more time in preparatory, in-house work and exploitation of any data and material that would be made available before the field tests (as mentioned in section 3.4.1).

The use of official cars for the transfer to the site and during the inspection would be most preferable, having appropriate warning signage (flashing lights). Members of the RSI Group have to respect the road/ tunnel rules and when outside from the inspection car – where this is permitted – should wear phosphorescent vest and take care not to burden the traffic and road users’ behavior with any unpredicted behaviour or risky activities on site.

## 4 The ECORoads tests sites

The five test sites of ECORoads, which have been selected among several candidatures through a multi-criteria ranking procedure, are the following:

- Kennedytunnel, Antwerp – Belgium: RSI at a 690m long tunnel under Schelde River, which consists of two unidirectional tubes with three lanes each for car traffic (also 1 tube for train traffic and 1 for pedestrians and cyclists).
- Krraba tunnel, Tirana – Elbasan highway – Albania: RSI at a twin tube tunnel (2.23-2.5km) with two lanes each. Open road sections are motorway on one side of the tunnel (RSI), while construction works are unfinished on the other (RSA).
- BAB A71/ Rennsteig Tunnel – Germany: 19.6km motorway (two traffic lanes per direction) with four consecutive tunnels with total length of 12.6km included. Proposed site for RSI: 10.3km (including the longest tunnel, 7.9km).
- Belgrade bypass Strazevica tunnel, Serbia: RSI at single tube tunnel (745m long) with one lane per direction (bidirectional traffic), along the Belgrade bypass, which is foreseen to be constructed in full motorway profile.
- Demir Kapija tunnel, Corridor X – Former Yugoslav Republic of Macedonia: Single tube tunnel (554m long) with one lane per direction. Open road sections are motorway on one side of the tunnel (RSI), while construction works are unfinished on the other (RSA).

Summarising, apart from RSI to be carried out for existing infrastructures, RSA is to be elaborated for future road and tunnel infrastructures, which are currently under construction or prepared at advanced level.

The joint road safety operations at Kennedy (RSI) and Krrabe (RSA and RSI) have already been performed. Inspections in tunnels were held during night closures in both cases, while inspections during daylight were performed by official cars with appropriate signage, under ordinary traffic conditions and accompanied by the IM personnel. The operations can be considered successful.

## 5 Conclusions

The ECORoads exercise differentiates from the formal procedures, in order to take advantage of its experimental character, to build on best practices and to provide solid and well documented outputs, and recommendations. The common approach developed and presented in this paper comprises a methodological framework that is based on most recent research and guidelines for RSA/RSI. The proposed tools are deviating somehow from the classic ones used, in order to cover the segmentation of road infrastructure as defined by ECORoads, i.e. open roads, transition areas and tunnel interiors, and checklists for tunnels and transition areas, with focus on road users' safety, have been drafted.

This approach is applied and shall be validated after the first set of ECORoads field tests. Therefore, a fine-tuning of the procedures might be necessary after assessing the success and any failures of the first two field tests. However, from the assessment of the procedures and the feedback of the involved parties in the first two field tests, it emerges that no substantial amendments should be considered, apart from some organisational (logistics) aspects that mostly have to do with the project particularities, such as the mobilisation of experts from different parts of Europe, the unfamiliarity with the scope of the project by other parties, the data requirements for each field test, etc. Anyhow, it was proved in practice, the usefulness of the exercise for the experts to take part in multidisciplinary international teams and especially for road experts to inspect tunnels from the road safety point of view.

## References

- [1] European Community: DIRECTIVE 2008/96/EC OF THE EUROPEAN PARLIAMENT AND OF THE COUNCIL of 19 November 2008 on road infrastructure safety management, 2004.
- [2] European Community: DIRECTIVE 2004/54/EC OF THE EUROPEAN PARLIAMENT AND OF THE COUNCIL of 29 April 2004 on minimum safety requirements for tunnels in the Trans-European Road Network, 2008.
- [3] ECORoads Consortium: Common Procedures, Common procedures, with the indication of the safety procedures, 2016.
- [4] PIARC: Road Safety Manual: Recommendations from the World Road Association. ISBN 2840601583, 2003.
- [5] Austrian Road Safety Fund – Federal Ministry for Transport, Innovation and Technology: Road Safety Inspection (RSI) Manual for Conducting RSI, 2014.
- [6] Norwegian Public Roads Administration – Directorate of Public Roads: Road Safety Audits and Inspections, 2014.
- [7] PIARC: Human Factors and Road Tunnel Safety Regarding Users. Reference 2008R17EN, 2008.
- [8] NITCHE, P.: PILOT4SAFETY RSA Training-Preliminary Part: Safety in road tunnels, 2010.





## REVIEW OF FASTEST PATH PROCEDURES FOR SINGLE-LANE ROUNDABOUTS

Saša Ahac, Tamara Džambas, Vesna Dragčević

*University of Zagreb, Faculty of Civil Engineering, Department of Transportation, Croatia*

### Abstract

Good safety performance, improved capacity, and numerous environmental benefits of modern roundabouts, in respect to signalised and stop-controlled intersections, have led to their rapid implementation on road traffic networks around the world. A well-designed roundabout reduces vehicle speeds upon entry and achieves smooth speed profile by requiring vehicles to negotiate the roundabout along a curved path. With that in mind, roundabout geometric design must include prediction of entry and circulation speed by estimating the fastest path into and through the circulatory roadway. Despite the fact that overall roundabout performance depends on the quality of the design features, inconsistencies in design standards and practices concerning the aforementioned performance check can be observed. In this paper, various fastest path analysis procedures for single-lane roundabouts (described in several European and US standards and guidelines) are presented, and the diversity of the approaches is pointed out.

*Keywords: roundabouts, traffic safety, geometric design, fastest path*

### 1 Introduction

Roundabout design is an iterative process that consists of: identification of initial design elements, performance checks (swept path, speed, and visibility analyses), and final design details. Although numerous studies confirmed the link between benefits of modern roundabouts and the quality of their design, inconsistencies in design standards and practices concerning the aforementioned performance checks can be observed [1-13].

It is well known that deflection is the most important roundabout design feature that controls the vehicular speed and affects the safety and capacity [3]. In other words, roundabout geometry has to reduce the speed on the approaches, limit the speed through the circulatory roadway and allow a safe transition back to the free flow [4-6]. The influence of deflection on roundabout performance is usually evaluated by defining the radius (or radii) of the centreline of a vehicle traveling along the so-called fastest path through the roundabout and then calculating the vehicle speed [4]. This theoretical fastest path is representative of most used trajectory by drivers under free flow conditions when minimizing their driving discomfort [3]. At first glance this roundabout performance check seems straightforward: firstly fastest path is defined, then the path radii is measured or calculated, and at the end the vehicle speed is estimated based on speed-radius relationship. However, inconsistencies in design standards and practices concerning procedures for the definition of the deflection, construction of the fastest path, vehicle speed estimation and the speed profile requirements can be observed. In this paper, the focus is set on displaying key elements of the vehicle speed analysis procedures for single-lane roundabouts described in several European and US standards and guidelines. Also, the diversity of the approaches concerning the fastest path analysis is pointed out.

## 2 Speed analysis procedures

Speed analysis on roundabouts can be conducted using 3 different approaches:

- by measuring the roundabout's geometry features and checking the achieved deflection (described in [7] – German guidelines);
- by measuring the roundabout's geometry features and then calculating the path radii and vehicle speed (described in [8-10] – Dutch, Slovenian and former Croatian guidelines);
- by constructing the fastest paths through the roundabout, measuring the path radii and then calculating the vehicle speed (described in [6], and [11-13] – American, Serbian, new Croatian, and French guidelines).

Essential input parameters used in these analyses are: relevant movements, deflection or fastest path elements, and minimum clearances from curbs. These parameters are presented below.

### 2.1 Definition of relevant movements

In general, the fastest path is defined for a vehicle traversing through the entry, around the central island, and out the relevant exit, for all approach lanes. However, analysed documents differ in terms of definition of relevant movements:

- guidelines [7-9] suggest that the deflection and/or speed analysis on the roundabout is conducted only for the straight passage of the vehicle, as shown in Figure 1 a,
- guidelines [13] define two movements that should be checked: straight passage through the roundabout and right-turn movements, as shown in Figure 1 b,
- according to [6], [11] and [12], the fastest paths must be drawn for all movements: straight passage, left-turn movements and right-turn movements, as shown in Figure 1 c.

Left-turn movements generally represent the slowest of the fastest paths (path with the minimum radii), and that right-turn movements may be faster than the through movements at some roundabouts [6]. Because of that, these movements should not be neglected during the fastest path and speed analysis. It is advisable that at least two movements are investigated for each approach: straight passage through the roundabout and right-turn movements (Figure 1 b).

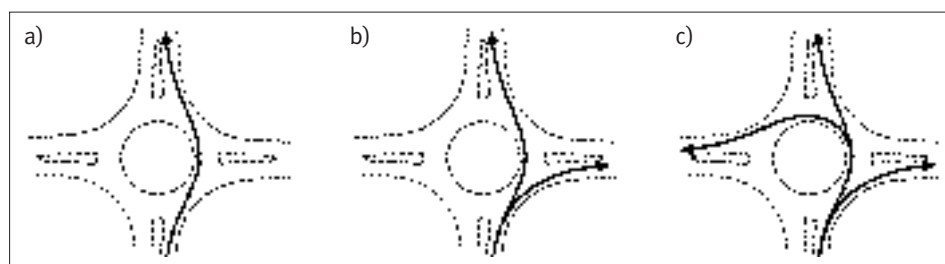


Figure 1 Relevant movements

### 2.2 Deflection and vehicle speed estimation

Beside the definition of relevant movements, documents presented in this paper differ in their approach to the estimation of vehicle speed and deflection impact assessment.

German guidelines [7] do not propose estimation of vehicle speed on roundabouts. According to this document, influence of the deflection is analysed by measuring the roundabout's ge-

ometry features: the entrance width ( $B_2$ ) and the distance ( $D$ ) between the edge of the central island and the right side of the splitter island on the access road, measured at the tangent point (Figure 2 a). If the distance ( $D$ ) is greater or equal to double entrance width ( $2B_2$ ), the roundabout's deflection is satisfactory.

According to guidelines [8-10], estimation of vehicle speed on roundabouts is conducted by measuring the roundabout's geometry features: the distance between the tangent of entry radius and the tangent of the exit radius ( $L$ ), and the distance between the edge of the central island and the right side of the lane of the access road, measured at the tangent point ( $U$ ) (Figure 2 b). With the aid of the  $L$  and  $U$  sizes the radius of the driving curve is calculated. Theoretical attainable vehicle entry speed is then defined on the basis of the speed-radius relationship, which is presented in the chapter 4.

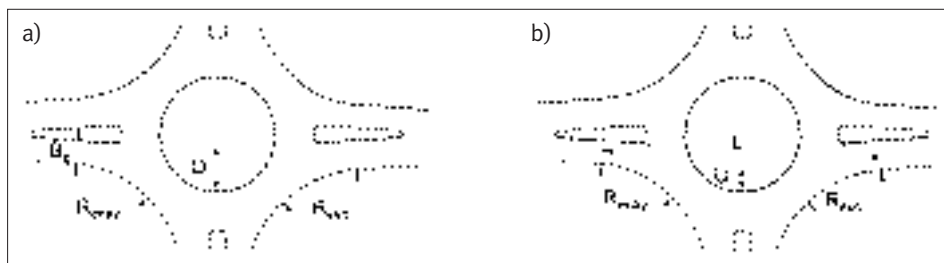


Figure 2 Deflection impact assessment

French guidelines [13] do not give detailed instructions on the construction of the fastest path (apart from their minimum clearances and maximum allowed radii), and claim that the dimensions of standard intersections listed in them result in preferable deflections and consequently vehicle speed. The estimation of vehicle speed on roundabouts is based on the construction of the fastest paths only according to [6], [11] and [13]. This procedure is composed from following steps: construction of the fastest path on the analysed roundabout, measurements of path radii ( $R_p$ ), and estimations of vehicle speed based on speed-radius relationship. The fastest path is defined as the smoothest, flattest path possible for a single vehicle, in the absence of other traffic and ignoring all lane markings, traversing through the entry, around the central island, and out the relevant exit [6].

### 2.3 Fastest path construction and elements

A true fastest path is comprised of a series of consecutive spiral curves that are tangent to each other [14]. It can be drawn by hand, or constructed by means of CAD software. Drawing the fastest paths by hand on scaled representation of the intersection results in natural, smooth vehicle path through the roundabout, but it requires significant engineering experience and skill. The minimum radii are measured on sketched path using suitable curve templates or by replicating the path in CAD and using it to determine the radii. If CAD software is applied, the fastest path can be constructed by application of 3<sup>rd</sup> degree (cubic) splines (Wisconsin method, [15-17]), or short straights and reverse curves (ACHD method, [14]), as shown in Figure 3. 3<sup>rd</sup> degree splines are piecewise polynomials of 3<sup>rd</sup> degree with function values and 2<sup>nd</sup> derivatives that agree at the points (nodes) where they join. When constructing the fastest path by this method, nodes must be defined in such way that they result in spline curve tangent with the prescribed minimum clearances, or curb offsets [17], described in the next subchapter. When short straights and reverse curves are used, the resulting path is not intended to trace the actual fastest path because it is replacing spirals with arcs and tangents [14]. In each case, the results are intended to provide arc radii that match the actual fastest path spiral radii at their tightest points.



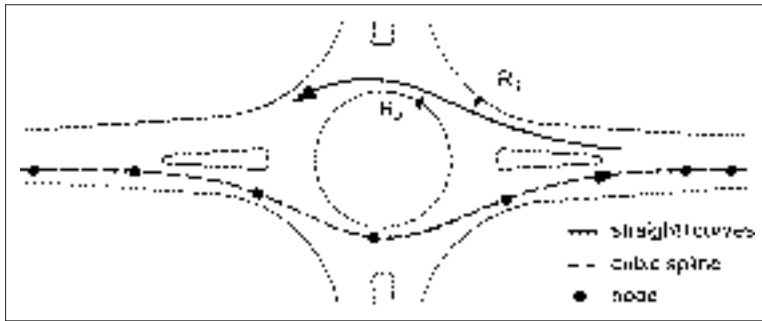


Figure 3 Fastest path construction elements

## 2.4 Minimum clearances

No matter what approach (and/or elements) is used in the construction of the fastest path, it should be drawn with the prescribed distances to the particular geometric feature (Figure 4): (a) painted edge line of the splitter island, (b) a right curb on the entrance and exit of the roundabout, and (c) a curb of the central island [6]. The fastest path minimum clearances defined in the analysed documents are shown in Figure 4.

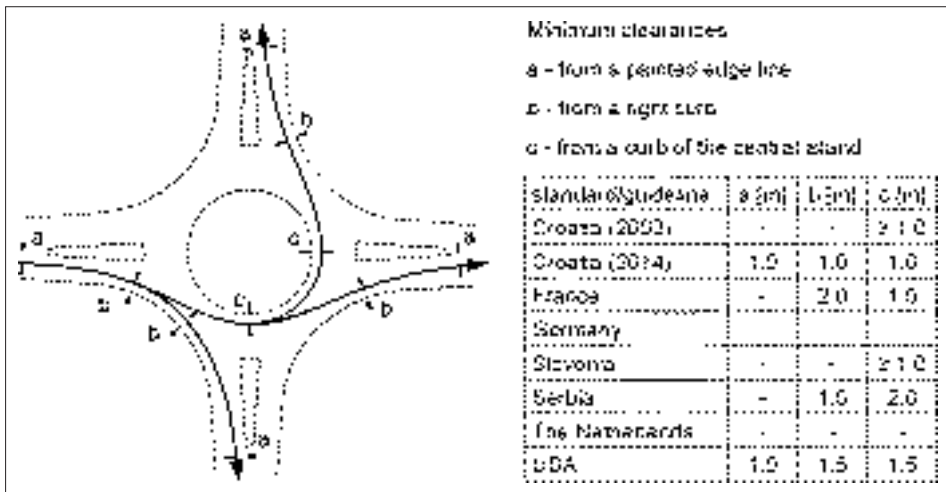


Figure 4 Fastest path minimum clearances

It should be noted that 1.0 m clearance does not always ensure unhindered passage of a passenger car (that is 2.0 m wide) through the roundabout. Because of that, larger minimum clearances are recommended, for instance the ones defined by [6]: a = 1.0 m, b = c = 1.5 m.

## 3 Fastest path critical radii

According to [13], a trajectory's deflection (i.e. the fastest path critical radius) is the radius of the arc that passes at a prescribed distance away from the edge of the central island and from the edges of the entry and exit lanes. The radius of this arc should be less than 100 m. According to [8-10], the radius of the driving curve is calculated with the aid of the following formula:

$$R = \frac{(0.25 \cdot L)^2 + (0.5 \cdot (U + 2))^2}{U + 2} \quad (1)$$

where  $R$  [m] is the radius of the driving curve,  $L$  [m] is the distance between the tangent of entry radius and the tangent of the exit radius, and  $U$  [m] is the deviation, shown in Figure 5 a. The design of the roundabout is correct if the radius of the driving path is between 22 and 23 m. According to [6], [11], and [12], in order to determine the design speed of the roundabout, the smallest radius along the fastest path must be defined. According to [6], smallest radius usually occurs on the circulatory roadway as the vehicle curves to the left around the central island ( $R_4$ , Figure 5 b). Nevertheless, in order to achieve required entry, circulating, and exit speeds, appropriate critical radii must be obtained on each segment of the fastest path. Because of that, all five critical path radii must be checked for each roundabout approach ([6], [11], [12]):

- the entry path radius ( $R_1$ ) which is the minimum radius on the fastest through path prior to the entrance line;
- the circulating path radius ( $R_2$ ), which is the minimum radius on the fastest through path around the central island;
- the exit path radius ( $R_3$ ), which is the minimum radius on the fastest through path into the exit;
- the left-turn path radius ( $R_4$ ), which is the minimum radius on the path of the conflicting left-turn movement;
- the right-turn path radius ( $R_5$ ), which is the minimum radius on the fastest path of a right-turning vehicle.

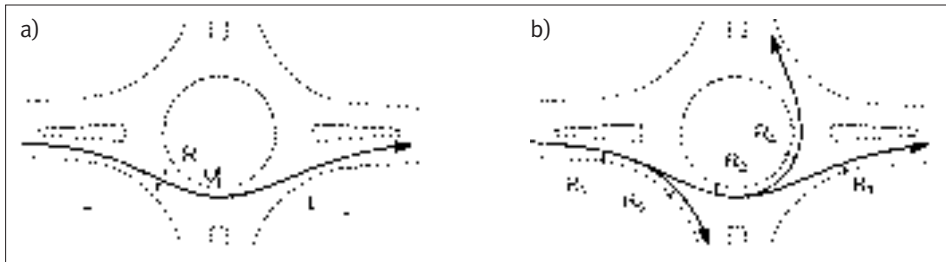


Figure 5 Fastest path critical radii

In order to achieve required speed differential between conflicting traffic movements, entry path radius ( $R_1$ ) must be larger (but not significantly [18]) than circulating path radii ( $R_2$  and  $R_4$ ), and at the same time smaller than exit path radius ( $R_3$ ). Also, circulating path radius ( $R_2$ ) must be smaller than exit path radius ( $R_3$ ) [6]. According to [18], approximate values of the radius of the conflicting left-turn movement ( $R_4$ ) vary from 11 to 19 meters, while the right-turn radius ( $R_5$ ) can vary from 54 to 73 meters, depending on the size of the analysed single-lane roundabouts.

## 4 Speed-radius relationship

Vehicle speed estimation is based on speed-radius relationship. The relation between the speed in the vehicle path curve and the radius of this curve according to [8-10], and [12] is:

$$V_i = 4.7 \cdot \sqrt{R_i} \quad (2)$$

where  $V_i$  [km/h] is the predicted design speed, and  $R_i$  [m] is the radius of curve.

According to [6] and [11], the speed of a vehicle is affected not only by the radius of vehicle path curve, but also both superelevation and the side friction factor. Speed can be calculated using the following formula:

$$V_i = \sqrt{127 \cdot R_i \cdot (f \pm e)} \quad (3)$$

where  $V_i$  [km/h] is the predicted design speed,  $R_i$  [m] is the radius of curve,  $f$  [-] is side friction factor (it varies with vehicle speed and can be determined in accordance with AASHTO guidelines [19]), and  $e$  [-] is superelevation. According to the analysed documents, superelevation values are assumed to be +0.02 [6] or +0.025 [11] for entry and exit curves and -0.02 [6] or -0.025 [11] for curves around the central island.

Design speed ( $V_i$ ) calculated for different path radii ( $R_i$ ) by means of formulas (2) and (3) (with assumed superelevation  $e = +0.025$ ), and differences ( $\Delta$ ) between them are shown in the Table 1. It can be noted that formula (2) results with larger design speed than formula (3), and that these discrepancies grow with the increase of the path radius.

**Table 1** Calculated design speed

$V_i$ [km/h]	$R_i$ [m]									
	15	20	25	30	35	40	45	50	55	60
eq. (2)	28.7	33.1	37.0	40.5	43.8	46.8	49.6	52.3	54.9	57.3
eq. (3)	25.4	28.3	30.7	33.0	35.0	36.8	38.5	40.0	41.4	42.7
$\Delta$	3.3	4.8	6.3	7.5	8.8	10.0	11.1	12.3	13.5	14.6

## 5 Design speed and speed differential on roundabouts

According to the analysed documents, if the calculated speed is above the recommended threshold, roundabout design elements should be modified. These recommended values differ significantly: they vary from 25 to 40 km/h according to [12], from 30 to 35 km/h according to [9] and [10], from 21 to 46 km/h according to [18], and according to [13] the overall geometric design should not allow speeds greater than 50 km/h.

In addition to appropriate maximum speeds, speed checks should consider the speed differential between conflicting traffic movements ([6], [11], [18]). Namely, large differentials between entry and circulating speeds may result in an increase in single-vehicle crashes due to loss of control [18]. According to [6], in order for vehicles to safely negotiate the roundabout, the maximum speed differential between movements should be approximately 15 to 25 km/h, while according to [11] this value should be approximately 10 to 20 km/h. It should also be noted that the fastest path methodology does not represent expected vehicle speeds, which can vary substantially based on vehicles construction, driving abilities, and tolerance for gravitational forces [18].

## 6 Conclusions

For a roundabout to operate safely and efficiently, the most critical design objective should be achieving appropriate vehicular speeds through the intersection. A review of vehicle speed analysis procedures for single-lane roundabouts given in this paper showed the significant discrepancies between the speed analyses approaches, values of key input parameters and speed, and consequently the speed analyses results. This highlights the need for further research on the relationships between roundabout geometric design elements and vehicle speed (especially for local traffic conditions). Results of this research would provide benefits in terms of performance based design of suburban roundabouts, and therefore should be incorporated in their design guidelines.

## References

- [1] Ahac, S., Džambas, T., Stančerić, I., Dragčević, V.: Performance checks as prerequisites for environmental benefits of roundabouts, 3<sup>rd</sup> International Conference on Road and Rail Infrastructures – CETRA 2014, Split, pp. 847-852, 2014.
- [2] Ahac, S., Džambas, T., Dragčević, V.: Sight distance evaluation on suburban single-lane roundabouts, GRAĐEVINAR 68 (2016) 1, pp. 1-10, doi: 10.14256/JCE.1455.2015
- [3] Bastos Silva, A., Seco, A.: Trajectory deflection influence on the performance of roundabouts, In European Transport Conference (ETC) Association for European Transport, Strasbourg, 2005.
- [4] Gallelli, V., Vaiana, R., Luele, T.: Comparison between simulated and experimental crossing speed profiles on roundabout with different geometric features, Procedia – Social and Behavioral Sciences 111, pp. 117–126, 2014.
- [5] Montella, A., Turner, S., Chiaradonna, S., Aldridge, D.: International overview of roundabout design practices and insights for improvement of the Italian standard, Canadian Journal Of Civil Engineering 40 (2013), pp.1215-1226, doi: 10.1139/cjce-2013-0123
- [6] ROUNDABOUTS: An Informational Guide, 2<sup>nd</sup> Edition, TRB, Washington, D.C., 2010.
- [7] Merkblatt für die Anlage von Kreisverkehren, K 10000, FGSV, Köln, 2006.
- [8] CROW: Eenheid in rotondes, CROW publication no.126, Ede, 1998.
- [9] TSC 03.341: 2011, KROŽNA KRIŽIŠČA, Ministrstvo za infrastrukturo in prostor – Direkcija RS za ceste, Ljubljana, 2011.
- [10] Dadić, I., Tollazzi, T., Legac, I., Čičak, M., Marić, V., Kos, G., Brlek, P.: Smjernice za projektiranje i opremanje raskrižja kružnog oblika – rotora, Institut prometa i veza, Zagreb, 2002.
- [11] Pravilnik o uslovima koje sa aspekta bezbednosti saobraćaja moraju da ispunjavaju putni objekti i drugi elementi javnog puta, Službeni glasnik RS, br. 50/2011
- [12] Deluka-Tibljaš, A., Tollazzi, T., Barišić, I. Babić, S., Šurdonja, S., Renčelj, M., Pranjić, I.: Smjernice za projektiranje kružnih raskrižja na državnim cestama, Hrvatske ceste d.o.o., Zagreb, 2014.
- [13] Aménagement des carrefours interurbains sur les routes principales, Carrefours plans – guide technique, SETRA, Centre de la Sécurité et des Techniques Routières, Bagneux Cedex, 1998.
- [14] ACHD Roundabout Design Guide, Appendix A: ACHD Fastest Path Procedure, Ada County Highway District, pp. A1-A26, 2011.
- [15] Roundabout Guide, Wisconsin DOT, 2011.
- [16] Facilities Development Manual, Chapter 11, Section 26, Wisconsin DOT, 2013.
- [17] Zheng, D., Chitturi, M., Bill, A., Noyce, D. A.: Comprehensive Evaluation of Wisconsin Roundabouts, Volume 1: Traffic Operations, Wisconsin DOT, 2011.
- [18] NHCRRP, Report FHWA-RD-00-067: Roundabouts: An Informational Guide, Federal Highway Administration, Transportation Research Board, Washington, 2000.
- [19] AASHTO Green Book – A Policy on Geometric Design of Highways and Streets, AASHTO, Washington, D.C., 2004.





## GEOMETRIC DESIGN OF TURBO ROUNDABOUTS ACCORDING TO CROATIAN AND DUTCH GUIDELINES

Tamara Džambas, Saša Ahac, Vesna Dragčević

*University of Zagreb, Faculty of Civil Engineering, Dpt. of Transportation, Croatia*

### Abstract

Turbo roundabout is a specific kind of multilane roundabout with spiral circulatory roadway and physical separation of traffic lanes. This particular roundabout layout was developed in the Netherlands in the late nineties of the last century with the aim of solving capacity and safety problems that occur in standard multilane roundabouts. In this paper geometric design of turbo roundabouts is analysed. Comparative analysis of turbo roundabout design procedures described in the latest Croatian and source Dutch guidelines is made, modifications of Croatian turbo roundabout in regard to Dutch layout are presented, and advantages and disadvantages of both design procedures are discussed.

*Keywords: turbo roundabouts, geometric design, Croatian guidelines, Dutch guidelines, comparative analysis, traffic safety*

### 1 Introduction

Because of greater traffic safety and greater capacity in respect to classic intersections, in the last two decades roundabouts became a common design choice for at-grade junction planning [1]. However, experience has shown that roundabouts with more than one traffic lane on the circulatory roadway and intersection approaches have poor traffic safety, and that practical capacity of such roundabouts is often lower than predicted [2]. The reasons for this are high driving speeds and a large number of potential conflicts at roundabout multilane entrances, exits and circulatory roadway [3]. In the past few years road designers are trying to solve these problems by introducing new roundabout layouts [4]. One such layout, which is increasingly used in design of new and reconstruction of existing roundabouts, is turbo roundabout. According to data on web page of Dirk de Baan, 408 turbo roundabouts were constructed worldwide to date, and most of them are located in the Netherlands, country where this particular roundabout was developed [5].

First guidelines for turbo roundabout application and design were published by a Dutch Information and Technology Platform CROW in 2008 [6]. At that time, Netherlands had 70 roundabouts of this kind. Soon after, a number of European countries began to develop their own regulations for the design of turbo roundabout (adjusted to their driving standards and local conditions) and to use turbo roundabouts in their engineering practice [4]. One of the most recent regulations on turbo roundabouts are Croatian guidelines [7]. Novelties in turbo roundabout geometric design introduced in these new Croatian guidelines, with regard to its source Dutch layout, are described below.

## 2 Turbo roundabout design procedures

According to Dutch [6] and Croatian guidelines [7], geometric design of turbo roundabouts can be carried out through the following steps: (1) selecting one of the available roundabout types; (2) defining a relevant design vehicle; (3) creating one of given turbo block templates with predetermined dimensions; (4) designing the remaining turbo roundabout elements; (5) conducting design vehicle horizontal swept path and fastest path vehicle speed analyses.

### 2.1 Turbo roundabout types

According to Dutch guidelines [6], seven basic types of turbo roundabouts can be constructed considering the planned traffic volume and capacity distribution on roundabout approaches (Fig. 1):

- Egg, Basic turbo, Knee, Spiral and Stretched-knee roundabout are recommended forms when one of traffic flows is predominant;
- Rotor and Star roundabout are recommended forms in case of equal traffic volumes on all approach legs.

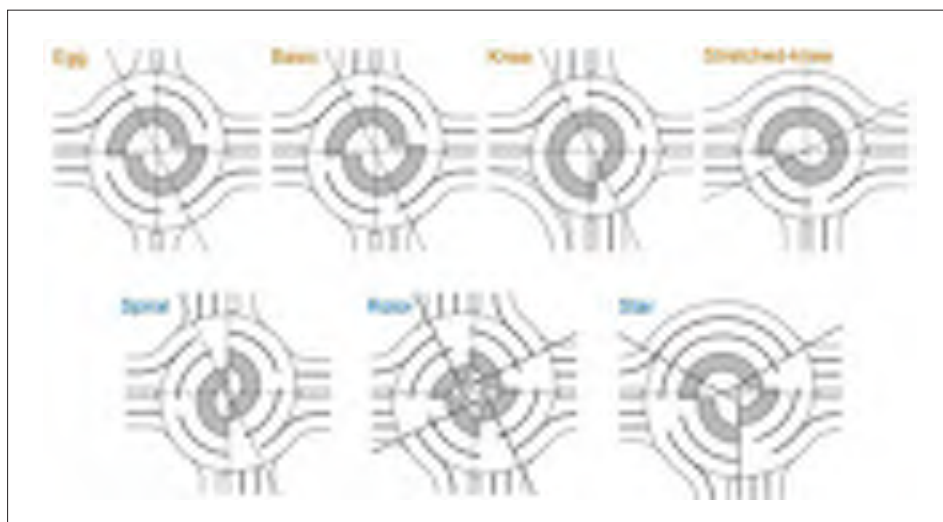


Figure 1 Four leg and three leg turbo roundabout variants [6]

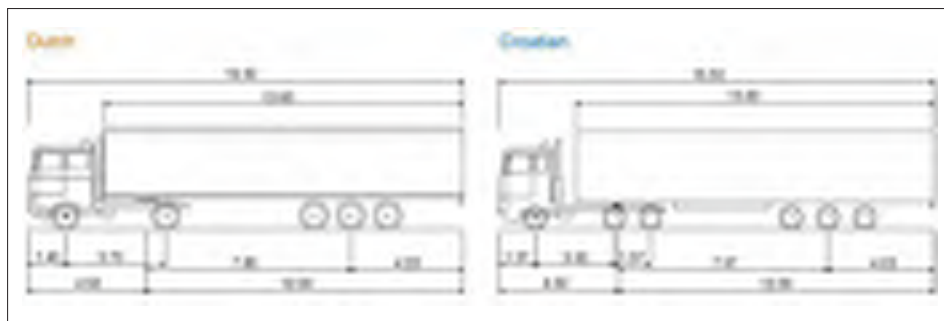
In Croatian guidelines [7], reduced number of aforementioned roundabout forms is given. Those forms are: Egg, Basic, Knee and Stretched-Knee roundabout. It can be noticed that all forms given in this document belong to a group of roundabouts recommended for use in a case of one dominant traffic flow. Considering the fact that [7] recommends the usage of turbo roundabouts when existing two-lane roundabouts have poor traffic safety and low capacity, and the fact that existing two-lane roundabouts often have evenly spread traffic volumes on all approach legs, it would be advisable that variants where traffic demand is evenly spread on all approach legs are also included.

### 2.2 Design vehicles

In Dutch guidelines [6] relevant design vehicle for turbo roundabout planning is a two-axle truck with a three-axle semitrailer (Fig. 2). As reported in Sweden [8], this is the most used vehicle combination in Europe. In Appendix D of Croatian guidelines for the design of ro-

undabouts [9], relevant design vehicle on Croatian state roads is a three-axle truck with a three-axle semitrailer (Fig. 2). According to [8], these three-axle tractors are necessary to avoid overloading of the driving axle due to the high transport loads.

The application of three-axle truck with a three-axle semitrailer as a design vehicle in Croatian design practise is questionable for the following reasons: this vehicle combination was chosen on the basis of report from Sweden [8], and vehicle fleet in Sweden significantly differs from vehicle fleet in Croatia; analysis of the catalogues and web pages of manufacturers that are common on Croatian market showed three-axle trucks with a three-axle semitrailers are extremely rare in Croatia, and that two-axle trucks with a three-axle semitrailers are far more frequent.



**Figure 2** Dutch and Croatian design vehicles

Croatian design vehicle width is 2.50 m [9], while the width of the Dutch design vehicle amounts to 2.55 m [6], which is the actual width of trucks with semitrailers in the catalogues of the vehicle manufacturers that are frequent on the European market, and the maximum allowed width of motor vehicles and trailers according to Committee Directive 2002/7/EC (96/53/EC) [10]. Considering the above, and the fact that larger vehicle width leads to more stringent requirements in terms of swept path analysis, it would be advisable that the width of Croatian design vehicle is also set to 2.55 m.

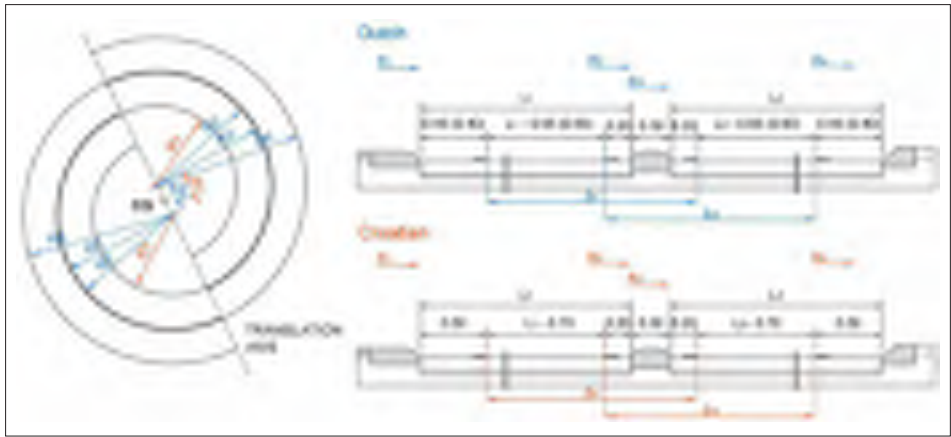
Along with the vehicle width, parameters that influence vehicle swept path are the distance from vehicle front to kingpin (on both analysed vehicles this distance is 4.50 m), and length of the semitrailer wheelbase (on Croatian design vehicle this length amounts 7.97 m, and on Dutch design vehicle 7.80 m) (Fig 2). Because of longer semitrailer wheelbase Croatian design vehicle occupies a greater area during the swept path analysis.

### 2.3 Turbo block templates

A turbo block is an auxiliary construction used in the design of turbo roundabout spiral circulatory roadway [3]. Turbo block for common Dutch and Croatian roundabout variants (Egg, Basic turbo, Knee and Stretched-Knee roundabout) consist of four pairs of circular arcs with consecutive larger radii ( $R_1, R_2, R_3, R_4$ ), which overlap on the line called a translation axis (Fig. 3).

Both Dutch [6] and Croatian [7] guidelines provide various turbo block templates with pre-determined dimensions, depending on the size of a roundabout radius. As shown in Table 1, most of the dimensions of turbo block templates given in those two documents differ for 5 cm. This difference arises from different widths of outer marginal strips on circulatory roadway: in [6] these strips are 45 cm wide, and in [7] 50 cm (Fig. 3). Widths of inner marginal strips, lane dividers and circulatory lanes between the marginal strips are equal.

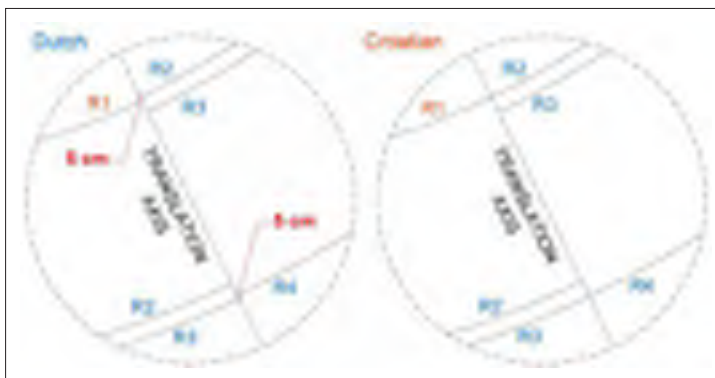




**Figure 3** Turbo block elements for common Dutch and Croatian roundabout variants

**Table 1** Dimensions of Dutch (NLD) [6] and Croatian (CRO) [7] turbo block templates

Element	Turbo roundabout template							
	Mini		Regular		Medium		Large	
	NLD	CRO	NLD	CRO	NLD	CRO	NLD	CRO
$R_1$ [m]	10.50	10.45	12.00		15.00	14.95	20.00	19.95
$R_2$ [m]	15.85		17.15		20.00		24.90	
$R_3$ [m]	16.15		17.45		20.30		25.20	
$R_4$ [m]	21.15	21.20	22.45		25.20	25.25	29.90	29.95
$L_1$ [m]	5.35	5.40	5.15		5.00	5.05	4.90	4.95
$L_2$ [m]	5.00	5.05	5.00		4.90	4.95	4.70	4.75
$\Delta v$ [m]	5.75		5.35	5.30	5.15		5.15	
$\Delta u$ [m]	5.05		5.05	5.00	4.95		4.75	



**Figure 4** Circular arc shifts [6] and overlapping [7] on translation axis

As shown on Fig. 4, in turbo block templates given in Dutch guidelines [6] circular arcs at one side of the translation axis are not entirely overlapping with circular arcs at the other side of the translation axis: in these templates 5 cm shift of circular arcs exists. In Croatian guidelines [7] this shift is eliminated by application of 5 cm wider outer marginal strips i.e. by

application of different circular arc radii and different radii centres on translation axis. This novelty introduced in Croatian guidelines is very notable, because the discrepancy of circular arcs, which occurs in Dutch regulations, may confuse the designer and lead to incorrect spiral circulatory roadway design.

## 2.4 Remaining turbo roundabout elements

After creating a turbo block, remaining turbo roundabout elements can be designed: central island, approaches, and raised mountable lane dividers. Turbo roundabout central island consists of traversable apron and non-traversable central part (Fig. 5). Guidelines considered in this paper define these elements in a different manner:

- In Dutch guidelines [6], non-traversable part of central island is “used for placing traffic signs that are cutting the view of the horizon in direction of travel”, and traversable apron is a “surface which enables passage of vehicles longer than 22 m through the inner circulatory lane”. According to this document, the beginning of traversable apron can be designed as flat or spiral. However, the application of flat beginning is recommended, because the spiral one is often ambiguous to the drivers that are approaching roundabout entrance, and it consequently leads to the conflict at roundabout circulatory roadway.
- In Croatian guidelines [7] non-traversable part of central island is defined as a “redundant roundabout space”, and traversable apron is a “surface where special emergency vehicles and regular vehicles in case of emergency can stop”. In this document all roundabout examples shown on figures have traversable apron with spiral beginning, and additional instructions on their design are not given in the text.

Despite the fact that non-traversable part of central island is not directly linked to traffic operations, the guidelines should emphasize that the design of this area of the central island has a great influence on roundabout traffic safety [11]. Also, according to [3], traversable apron usually serves for traffic operations, and not for emergency stops. It can be concluded that the definitions of central island elements placed by Dutch guidelines [6] are more appropriate: in these guidelines the designer is warned about disadvantages of application of traversable apron with spiral beginning, the importance of central island and the proper use of traversable apron.



Figure 5 Turbo roundabout central island

Dutch guidelines [6] provide following directions for turbo roundabout approach leg positioning: “turbo roundabout approaches should be aligned at right angles to the circulatory roadway, and because of the rideability of long vehicles these angles should amount  $90^\circ$ ”. In Croatian guidelines [7] detail guidelines on approach leg positioning are not provided. It should be noted that approaches aligned at  $90^\circ$  angles are often difficult to plan, especially in a case of reconstruction of existing intersections located at sites with significant spatial limitations. Considering the above, other possible alignments of turbo roundabout approaches in future studies should be examined: non-radial, curvilinear etc.

Guidelines presented in this paper recommend the use of raised mountable lane dividers – important turbo roundabout element which prevents conflicts on roundabout exits and circulatory roadway, reduces driving speed, and increases capacity and traffic safety [2-3]. It should be noted that these dividers hinder the maintenance and snow removal process, and represent a dangerous obstacle for motorcyclists [12], which is the main reason why opinions about their application are still divided.

## 2.5 Performance checks

After designing a turbo roundabout, design vehicle horizontal swept path and fastest path vehicle speed analyses must be carried out [6, 7]. If analyses show that applied roundabout elements do not fulfil both swept path and fastest path vehicle speed requirements, redesign of roundabout elements is required.

According to Croatian guidelines [7], “when conducting a critical turning movement the design vehicle must not track over the traversable central apron, or the 30 cm wide raised mountable lane dividers placed between the circulatory lanes, and it can track over the traversable beginning of raised mountable lane divider”. In Dutch guidelines [6], such behaviour is recommended, but not mandatory. More stringent swept path requirements set by Croatian regulations are favourable from the aspect of design vehicle’s driving comfort and therefore should always be respected. This is especially important if relevant design vehicle on proposed turbo roundabout location is a long passenger vehicle.

Dutch [6] and Croatian guidelines [7] do not provide detailed instructions on assigning input parameters for the swept path testing procedure; they only define values of entry path radius. Those procedures can therefore lead to oversized and undersized roundabout solutions: the designer can conclude that chosen roundabout elements are satisfactory if they accommodate the design vehicle swept path in any manner – with lack or extra space for unobstructed passage. Besides that, minimum clearances between the outside edges of the design vehicle’s tire track and the edges of the roadway should always be assigned, because they are necessary for a long vehicle driver to maintain driving direction [13].

Both guidelines [6, 7] are providing same directions for turbo roundabout fastest path vehicle speed analysis procedure: (1) analysis should be carried out for through movement, right turn from the outer entry lane and right turn from the inner entry lane; (2) fastest paths should always be assigned in respect to potential points of impact and distanced from them for 1 m; (3) fastest path vehicle speed should amount between 37 and 40 km/h [6], i.e. 35 and 37 km/h [7]. Minimum value for this speed, which is in direct correlation with design vehicles’ driving comfort, is not recommended.



Figure 6 Fastest path vehicle speed analysis

Simple swept path analysis carried out on a standard turbo roundabout of regular size with a passenger car from Dutch regulations [14] showed that 1 m clearance does not always ensure unhindered passage of a passenger car: while driving straight through a turbo roundabout vehicle was tracking over the outer edges of the roadway (Fig. 6). Considering the above, larger minimum clearances should be applied.

### 3 Conclusion

Analysed Croatian and Dutch guidelines for the design of turbo roundabouts differ in the following: number of turbo roundabout variants, information about relevant design vehicles, dimensions of certain turbo block and cross-section elements, definition of particular roundabout elements, and input parameters in roundabout performance checks. These differences are expected due to the fact that local conditions in Croatia and Netherlands are different, and the fact that at the time when Croatian guidelines were in developing phases some new findings about turbo roundabouts were available (new dimensions of turbo block templates, more stringent swept path requirements which lead to higher driving comfort).

Despite the previous differences, turbo roundabout planning procedures described in Croatian and Dutch guidelines are very similar: firstly the initial roundabout scheme is designed, and then swept path and fastest path vehicle speed analyses are carried out. This design approach therefore greatly depends on the quality of performance checks, and leaves a great freedom to the designer about the decision whether the project solution is acceptable or not. Considering the above, it would be advantageous that these guidelines provide more detail instructions for conducting horizontal swept path and fastest path vehicle speed analysis: a method of assigning the design vehicle path; minimum clearances; lowest recommended speed values for passenger cars.

### References

- [1] Omazić, I., Dimter, S., Barišić, I.: Kružna raskrižja – suvremeni način rješavanja prometa u gradovima, e-gfos, 1(1), pp. 54-66, 2010.
- [2] Engelsman, J. C., Uken, M.: Turbo Roundabouts as an Alternative to Two Lane Roundabouts, The challenges of implementing policy?, 26<sup>th</sup> Southern African Transport Conference (SATC 2007), Pretoria, pp. 581-589, 2007.
- [3] Fortuijn, L. G. H.: Turbo Roundabouts: Design Principles and Safety Performance, Journal of the Transportation Research Board 2096 (2009), pp. 16–24, doi: <http://dx.doi.org/10.3141/2096-03>
- [4] Tollazi, T., Renčelj, M.: Modern and alternative types of roundabouts – state of the art, Sustainable Urban Development, 9<sup>th</sup> International Conference on Environmental Engineering, Vilnius, pp.1-7, 2014.
- [5] Dirk de Baan, [www.dirkdebaan.nl](http://www.dirkdebaan.nl), 09.03.2016.
- [6] Turborotondes, Publication No. 257, CROW, 2008.
- [7] Smjernice za projektiranje kružnih raskrižja sa spiralnim tokom kružnog kolnika na državnim cestama, Hrvatske ceste, 2014.
- [8] Aurell, J., Wadman, T.: Vehicle Combinations Based on the Modular Concept, Report No. 1/2007, Volvo Trucks, 2007.
- [9] Smjernice za projektiranje kružnih raskrižja na državnim cestama, Hrvatske ceste, 2014.
- [10] Directive 2002/7/EC of the European Parliament and of the Council of 18 February 2002 amending Council Directive 96/53/EC laying down for certain road vehicles circulating within the Community the maximum authorised weights in international traffic and the maximum authorised weights in international traffic, OJ L 67.

- [11] Ahac, S., Džambas, T., Dragčević, V.: Sight distance evaluation on suburban single-lane roundabouts, GRAĐEVINAR, 68 (2016) 1, pp. 1-10, doi: 10.14256/JCE.1455.2015
- [12] Brilon, W.: Roundabouts: a State of the Art in Germany, 4<sup>th</sup> International Conference on Roundabouts, Seattle, pp. 1-16, 2014.
- [13] Džambas, T., Ahac, S., Dragčević, V.: Design of turbo roundabouts based on the rules of design vehicle movement geometry, Journal of Transportation Engineering, 142 (2016) 3, doi: 10.1061/(ASCE)TE.1943-5436.0000850
- [14] Aanbevelingen voor verkeersvoorzieningen binnen de bebouwde kom, Publication No. 723, CROW, 2004.



## SWEPT PATH ANALYSIS ON ROUNDABOUTS FOR THREE-AXLE BUSES – REVIEW OF THE CROATIAN DESIGN GUIDELINES

Šime Bezina, Ivica Stančerić, Saša Ahac

*University of Zagreb, Faculty of Civil Engineering, Croatia*

### Abstract

Latest edition of Croatian design guidelines for roundabouts was published in 2014, and its usage is mandatory for intersections on the state roads. This paper offers a review of aforementioned guidelines, with the emphasis on the roundabout geometric design, which are presented through several theoretical examples of suburban roundabouts with various external radii. On these roundabouts swept path analysis for tri-axle bus is conducted, and results of this analysis are commented on. This long passenger vehicle was chosen for the analysis even though it is not defined as a design vehicle in guidelines, due to the following facts: (1) Croatia is a popular tourist destination, with numerous guests arriving from distant locations, and tri-axle buses are a common mean of their transport; (2) swept path analyses have shown that the space needed by the vehicle body during the turning movements is larger for this type of vehicle, compared to design vehicles from the guidelines. Because of that, this paper presents the impact of aforementioned long passenger vehicles on the geometric design of roundabouts.

*Keywords: Croatian guidelines, roundabouts, design vehicle, three-axle buses*

### 1 Introduction

Today the existing three-leg and a four-leg cross intersections are often replaced by roundabouts. Compared to conventional intersections, application of roundabouts in the road network has many positive effects, such as increased safety and intersection capacity, reduced maintenance costs and air pollution [1, 2]. However, in some cases these benefits may be annulled due to the poor geometric design, which can be result of wrong selection of the design vehicle or even lack of critical performance check: the swept path analysis [3].

Croatian guidelines for roundabout design were published in June 2014 [4]. They define two design vehicles for swept path analysis, semitrailer truck and truck with trailer. Unlike for example Austrian [5] and German guidelines [6], Croatian guidelines do not define buses as design vehicles, even though buses play an important role in the transport of passengers in long-distance lines in Croatia (such as the transport of tourists to popular destinations on the Croatian coast). Tourism is one of the key drivers of the Croatian economy: the increase in the number of tourists is recorded each year, and the total income from these activities in 2014 accounted for 17.2% of GDP [7]. Because of the cost effectiveness (lower costs) these passengers are increasingly transported with three-axle buses with maximum permissible length up to 15.0 m [8]. Previous research [9] showed that three-axle buses occupy larger area when turning compared to heavy goods vehicles (semitrailer truck). Because of that, swept path analysis for six three-axle buses from different manufacturers [10 – 13] has been conducted on a few examples of roundabouts designed according to Croatian guidelines [4]. The main goal for this research was to define the impact that these vehicles have on the operating ca-

pabilities and geometric design of roundabouts. All bus movement trajectories were drawn by Vehicle Tracking software [14].

## 2 Geometric design of roundabouts according to the Croatian guidelines

Geometric design of suburban roundabouts according to the Croatian guidelines is carried out in nine major steps [4]:

- 1) selection of the external radius ( $R_v$ ),
- 2) selection of the two-axle design vehicle and determination of the circulatory roadway width ( $u$ ) by using vehicle movement trajectory while driving in a full circle (Fig. 1a, chapter 2.1),
- 3) selection of the heavy goods design vehicle and determination of the central island truck apron width ( $u'$ ) by using vehicle movement trajectory while driving in a full circle (Fig. 1b, chapter 2.1),
- 4) selection of the approach roadway lane width ( $v$ ) and splitter island form and length ( $m$ ) (Fig. 2),
- 5) designing the outer roadway edge on entry: selection of the entrance width ( $e_{ul}$ ) and the outer edge radius ( $R_{ul}$ ) (Fig. 2),
- 6) designing the outer roadway edge on exit: selection of the exit width ( $e_{iz}$ ) and the outer edge radius ( $R_{iz}$ ),
- 7) control of the entry angle ( $\Phi$ ) and roadway widening severity ( $S$ ),
- 8) swept path analysis on the roundabout for the design vehicle and for all movement directions,
- 9) determination of the fastest path through the roundabout.

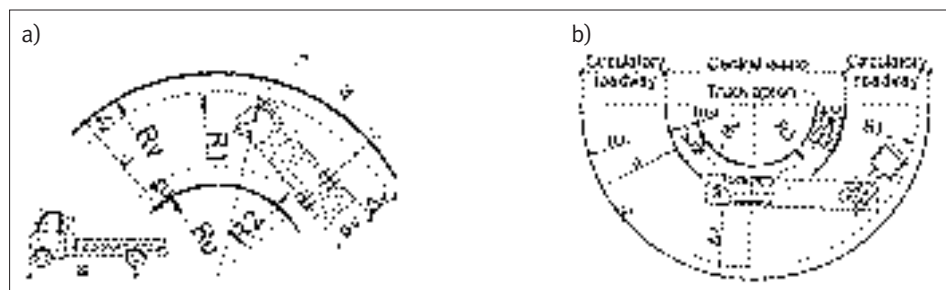


Figure 1 Determination of the circulatory roadway and truck apron width [4]

If the swept path analysis shows that the entry and exit lane widths ( $e_{ul}/e_{iz}$ ) are insufficient for unobstructed movement of the design vehicle, steps 5 to 9 have to be repeated. Roundabout design process is an iterative one.

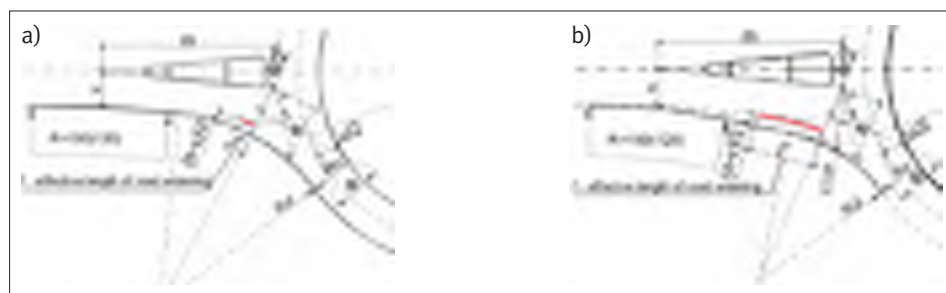


Figure 2 Outer roadway edge design and entry angle determination [4]

## 2.1 Recommended dimensions of the roundabout design elements

On small and medium sized rural and suburban roundabouts ( $R_v = 11.0 - 25.0$  m) splitter islands usually have triangular form (Fig. 2). Their recommended length (m) ranges from 15.0 to 50.0 m. Conditions for unobstructed vehicle movement on roundabout entry and exit are achieved by proper selection of the entry ( $R_{ul}$ ) and exit ( $R_{iz}$ ) radii, the entrance and exit widths ( $e_{ul}/i_{z}$ ), the circulatory roadway width ( $u$ ), and by the proper design of the outer roadway edge on entry and exit. The outer roadway edge can be formed in two different ways:

- with shorter effective roadway widening length ( $l'$ ) – the outer roadway edge is composed of circular arc and straight line which is parallel to the side of the triangular splitter island (Fig. 2a),
- with longer effective roadway widening length ( $l'$ ) – the outer roadway edge is composed of circular arc and straight line which isn't parallel to the side of the triangular splitter island (Fig. 2b).

The designer has to choose the way which ensures unobstructed vehicle movement. Decision must be based on the design vehicle swept path analysis. Recommended and limit values of roundabout design elements are given in Table 1.

**Table 1** Recommended and limit values of roundabout design elements [4]

Element	Recommended values	Limit values
$e_{ul}/i_{z}$ [m]	4.0 – 7.0	3.6 – 10.0
$v$ [m]	3.0 – 3.5	2.5 – 7.0
$R_{ul}$ [m]	8.0 – 20.0	6.0 – 25.0
$R_{iz}$ [m]	10.0 – 25.0	8.0 – 50.0

Circulatory roadway width ( $u$ ) is determined on the basis of the drawn two-axle vehicle movement trajectory, while driving in a full circle (Fig. 1a). Values ( $u$ ) are given in guidelines [4] only for specific ( $a$ ) and ( $R_1$ ) values, and they range from 2.0 to 8.3 m. The minimum central island truck apron width ( $u'$ ) is 1.0 m. At the end of roundabout design process specific parameters have to be controlled: effective roadway widening length ( $l'$ ), entry angle ( $\Phi$ ) and roadway widening severity ( $S$ ) (Fig. 2). Entry angle ( $\Phi$ ) limit values range from 0 to 77 °, while the recommended values range from 20 to 40 °. Dimensionless roadway widening severity ( $S$ ) is calculated according to the following formula:

$$S = 1.6 \cdot (e - v) / l' \quad (1)$$

where  $e$  [m] is the entrance width,  $v$  [m] is the approach lane width, and  $l'$  [m] is the roadway widening length.

Limit and recommended ( $S$ ) values ranges from 0 to 2.9. If the ( $S$ ) value is greater than 1.0, roadway widening is short and sharp (Fig. 2a). Longer roadway widenings (Fig. 2b) on entrance are more effective and desirable especially when vehicles with higher approaching speeds are expected. Usually longer roadway widening meet boundary condition:  $S < 2.9$ .

## 2.2 Design vehicles and swept path analysis

Roundabout swept path analysis can be performed with two design vehicles [4]: semitrailer truck ( $l = 16.5$  m) and truck with trailer ( $l = 18.75$  m). Dimensions of those vehicles (Fig. 3) are in compliance with EU Directive [8]. Complete dimensions of two-axle vehicles are not given in guidelines [4]: only ( $a$ ) values are given and they ranges from 3.0 to 9.7 m. These two-axle



vehicles are only used for the determination of the circulatory roadway width ( $u$ ) (Fig. 1a). Their choice should be harmonized with the needs of users at the proposed roundabout location and with the consent of the road administration.



Figure 3 Design vehicles [4]

Swept path analysis is conducted by drawing the design vehicle (body) movement trajectories in all possible directions on roundabout blueprint. It ensures that conditions for unobstructed vehicle movement on roundabout entry and exit are achieved. The minimum protective lateral width along the trajectories ( $z_u$ ) is 0.5 m (exceptionally 0.3 m) on all segments, except on the outside edge of the circulatory roadway where the minimum lateral width ( $z$ ) is 1.0 m (Fig. 1).

### 3 Research

Research presented in this paper was conducted on five roundabouts that were designed on the basis of the following input data (Table 2):

- approach road axis intersect at a right angle ( $90^\circ$ );
- roundabouts outer radii ( $R_v$ ) range from 15.0 to 25.0 m (step 2.5 m);
- splitter islands are triangular, 30.0 m long, with side slope 1:15;
- approach roadway lanes are 3.3 m wide.

Table 2 Applied design elements dimensions

Dimensions	RO 1	RO 2	RO 3	RO 4	RO 5
$R_v$ [m]	15.0	17.5	20.0	22.5	25.0
$R_1$ [m]	14.0	16.5	19.0	21.5	24.0
$sv+\Delta v$ [m]	5.70	5.14	4.75	4.48	4.24
$u$ [m]	7.25	6.75	6.25	6.00	5.75
$u'$ [m]	1.0	1.0	1.0	1.0	1.0
$e_{ul}$ [m]	5.0	5.0	6.0	6.0	6.0
$e_{iz}$ [m]	6.0	6.0	6.0	6.5	6.5
$R_{ul}$ [m]	13.0	13.0	13.0	13.0	13.0
$R_{iz}$ [m]	15.0	15.0	15.0	15.0	15.0
$\Phi$ [°]	37.5	42.8	46.4	46.8	46.8
$S$	0.48	0.39	0.58	1.16	1.10

Radii ( $R_1$ ) were determined on the basis of the roundabout outer radii ( $R_v$ ), in a way that values ( $R_v$ ) were reduced by the protective lateral width  $z = 1.0$  m (Fig. 1b, Table 2). Circulatory roadway widths ( $u$ ) were defined as the sum of the widths  $z = 1.0$  m,  $z_u = 0.5$  m and  $sv+\Delta v$ , rounded to 0.25 m (Table 2). Widths  $sv+\Delta v$  were determined on the basis of the drawn two-axle vehicle (EvoBus, Setra S 415 H,  $l = 12.2$  m [10]) movement trajectory, while driving in a full circle of radii ( $R_1$ ). Circulatory roadway widths were defined in that way because they are not specified in the guidelines [4] for the selected two-axle bus ( $a = 8.9$  m) and all selected radii

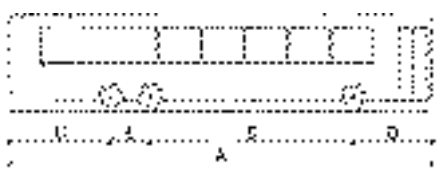
(R1) (Table 2). Initial entrance widths (eul), exit widths (eiz), outer edge radii and outer edge radii (Rul and Riz) were also selected.

After all the roundabout elements were selected and initial roundabouts design was finished, swept path analyses were conducted. Swept path analyses were conducted on all five roundabouts (Table 2), for all directions and for selected design vehicle (Fig. 3). Semitrailer truck was selected as a design vehicle because it occupies greater turning width than truck with trailer [9]. All trajectories were drawn by Vehicle Tracking software [14]. After swept path analyses were finished, following elements were defined: truck apron widths (u'), entrance widths (eul), exit widths (eiz), outer edge radii (Rul) and outer edge radii (Riz) (Table 2). Entry and exit roadways were formed with longer effective widening (l') to ensure unobstructed design vehicle movement. Entry angles ( $\Phi$ ) and widening severity (S) were also controlled. Obtained values of ( $\Phi$ ) angle are within limit range, while (S) values are within the recommended range (Table 2).

Swept path analyses were then conducted again on all five roundabouts, but this time for three-axle buses with the length up to 15.0 m (Table 3). Their dimensions were obtained from the web pages [10- 13] of renowned European bus manufacturers, because they are not defined in the guidelines [4]. Selected buses are designed for international passenger transport (Setra ComfortClass S 519 HD, Scania OmniExpress, and Irizar i6), and for intercity passenger transport (MB Citaro LU, Setra MultiClass S 419 UL, and Volvo 8900) (Table 3).

**Table 3** Three-axle buses dimensions [10 – 13]

Vehicle	Dimensions [m]				
	A	B	C	D	E
Setra CC S519 HD	14.945	2.890	3.315	7.140	1.600
Scania Om.Ex.	14.890	2.795	3.395	7.200	1.500
Irizar i6	14.980	2.690	3.510	7.280	1.500
MB Citaro LU	14.995	2.705	3.400	7.290	1.600
Setra MC S419 UL	14.980	3.160	3.300	6.920	1.600
Volvo 8900	14.960	2.769	3.597	7.194	1.400



A: total length  
 B: front overhang  
 C: rear overhang  
 D: wheel base: front axle – rear axle  
 E: wheel base: rear axle – trailing axle  
 Vehicles width: 2.550 m

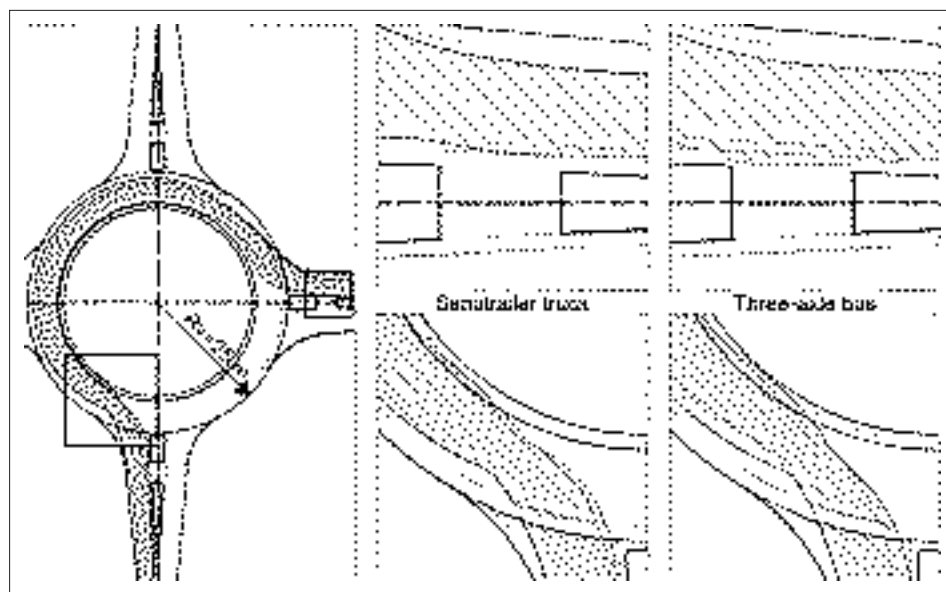
## 4 Research results

Results of the swept path analyses showed that all six three-axle buses, regardless of the type and manufacturer, can pass through all five designed roundabouts, but with certain problems that can slow down their movement. Most common problems that occurred are that buses had to use protective lateral widths (at the entrance and exit) and the truck apron (Table 4). In both cases minimum prescribed [4] protective lateral widths of 0.5 (0.3) m, or 1.0 m were not provided. Research showed that there is also an additional problem: when buses were entering the circulatory roadway their rear overhangs swung and used protective lateral width along the splitter island near the pedestrian crossing (Fig. 4). This can cause discomfort and reduced security of pedestrians.

**Table 4** Results of the swept path analysis on roundabouts for three-axle buses

Vehicle	RO 1				RO 2				RO 3				RO 4				RO 5			
	→	↑	←	⊔	→	↑	←	⊔	→	↑	←	⊔	→	↑	←	⊔	→	↑	←	⊔
Setra CC S 519 HD	■	●	●▲	●▲	✓	✓	▲	▲	✓	✓	▲	▲	●	●▲	●	●	●	●▲	●▲	●▲
Scania OmniEx.	■	●	●▲	●▲	✓	✓	▲	▲	✓	✓	▲	▲	●	●▲	●▲	●	●	●▲	●▲	●▲
Irizar i6	■	●	●▲	●▲	✓	✓	▲	▲	✓	✓	●▲	●▲	●	●▲	●▲	●▲	●	●▲	●▲	●▲
MB Citaro LU	■	●	●▲	●▲	✓	✓	▲	▲	✓	✓	●▲	●▲	●	●▲	●▲	●▲	●	●▲	●▲	●▲
Setra MC S 419 UL	■	●	●▲	●▲	✓	✓	▲	▲	✓	▲	●▲	●▲	●	●▲	●▲	●▲	●	●▲	●▲	●▲
Volvo 8900	■	●	●▲	●▲	✓	✓	▲	▲	✓	✓	●▲	●▲	●	●▲	●▲	●▲	●	●▲	●▲	●▲

**Legend:**  
 → - right; ↑ - straight; ← - left; ⊔ - U-turn; ● - uses lateral protective width on entrance;  
 ■ - uses lateral protective width on exit; ▲ - uses truck apron on exit; ✓ - no problem



**Figure 4** Semitrailer truck and three-axle bus movement trajectories

The main reason for these problems are that three-axle buses occupy greater widths while turning than semitrailer truck or two-axle bus (Table 5). Additional research showed (Table 5) that three-axle buses occupy from 0.21 to 0.34 m greater width than semitrailer truck, and from 0.47 to 0.89 m greater width than two-axle bus, while driving in full circle of radii (R1). Most suitable for the movement of three-axle buses have proved to be roundabouts RO 2 ( $R_v = 17.5$  m) and RO 3 ( $R_v = 20.0$  m). Most unfavourable has proved to be roundabout RO 5 ( $R_v = 25.0$  m), due to the usage of the protective area with rear overhang at the entrance and exit.

**Table 5** Width (u) which vehicles occupy while driving in a full circle of radii (R<sub>1</sub>)

Vehicle	u [m]				
	R1 = 14.0 m	R1 = 16.5 m	R1 = 19.0 m	R1 = 21.5 m	R1 = 24.0 m
Setra MC S 415 H, l = 12.2 m	5.70	5.14	4.75	4.48	4.25
Semitrailer truck, l = 16.5 m	6.25	5.71	5.20	4.83	4.51
Setra CC S 519 HD	6.65	5.91	5.40	5.03	4.75
Scania OmniExpress	6.61	5.88	5.38	5.01	4.73
Irizar i6	6.59	5.86	5.36	5.00	4.72
Mercedes Benz Citaro LU	6.62	5.88	5.38	5.01	4.73
Setra MC S 419 UL	6.69	5.94	5.43	5.06	4.77
Volvo 8900	6.59	5.86	5.36	4.99	4.72

## 5 Conclusions

Research presented in this paper has shown that analysed three-axle buses can physically pass through roundabouts designed according to Croatian guidelines, but with certain restrictions, which may slow down their movement and passenger comfort. Namely, while negotiating the intersection, these vehicles used the truck apron and lateral protective width along the movement trajectories. That happens because those vehicles occupy greater swept path width than the semitrailer truck while entering and exiting the roundabout. The reason for that are the vehicle dimensions, i.e. the sum of the length of the front overhang and wheel base, which range from 9.963 to 10.08 m for the selected vehicles. Based on the research results summarized above, the following recommendations for the design of roundabouts, on which an increased numbers of three-axle buses are present, can be made:

- outer roundabout radius (R<sub>v</sub>) should be between 17.5 and 22.5 m,
- entrance and exit widths should be greater than the ones defined for the semitrailer truck,
- circulatory roadway width should accommodate buses in order to achieve greater passenger comfort (avoiding the use of truck apron),
- all swept path analyses should be conducted for three-axle bus,
- the splitter island should be wider than minimum prescribed (1.6 (2.0) m) in order for pedestrians and cyclists to feel safe.

## References

- [1] Hydén, C., Várhelyi, A.: The effects on safety, time consumption and environment of large scale use of roundabouts in an urban area: a case study, *Accident Analysis and Prevention* 32, 11–23, 2000.
- [2] Mandavilli, S., Russell, E.R., Rys, M.J.: Impact of Modern Roundabouts on Vehicular Emissions, *Proceedings of the 2003 Mid-Continent Transportation Research Symposium*, Ames, Iowa, USA, 2003.
- [3] Stančerić, I., Dobrica, T., Ahac, S., Dragčević, V., Tenžera, D.: Offtracking control requirements for quality roundabout design, *3rd International Conference on Road and Rail Infrastructures*, Split. *Proceedings*, Zagreb, Department of Transportation, Faculty of Civil Engineering, pp. 263-268, 2014.
- [4] Smjernice za projektiranje kružnih raskrižja na državnim cestama, Građevinski fakultet Sveučilišta u Rijeci, Rijeka, srpanj 2014.
- [5] Plangleiche Knoten – Kreisverkehr, Österreichische Forschungsgesellschaft Straße-Schiene-Verkehr, (RVS 03.05.14), Wien, 2001.
- [6] Merkblatt für die Anlage von Kreisverkehren, Ausgabe 2006, FGSV Verlag, Köln

- [7] Turizam u brojkama 2014, Ministarstvo turizma Republike Hrvatske, 2015.
- [8] Directive 2002/7/EC of the European Parliament and of the Council of 18 February 2002 amending Council Directive 96/53/EC laying down for certain road vehicles circulating within the Community the maximum authorised dimensions in national and international traffic and the maximum authorised weights in international traffic, OJ L 67, 09.03.2002.
- [9] Ahac, S.: Design of suburban roundabouts based on rules of vehicle movement geometry. Doctoral thesis, Faculty of Civil Engineering, University of Zagreb, 2014.
- [10] EvoBus GmbH: <https://www.evobus.com/>, 02.02.2016.
- [11] Volvo buses: <http://www.volvobuses.com/>, 02.02.2016.
- [12] Scania buses and coaches: <http://www.scania.com/global/buses-coaches/>, 02.02.2016.
- [13] Irizar: <http://www.irizar.com/>, 02.02.2016.
- [14] Vehicle Tracking: Integrated swept path analysis software. [www.autodesk.com/](http://www.autodesk.com/)



## THE EVALUATION OF BICYCLE PATHS ON BRIDGES

Hwachyi Wang<sup>1,2</sup>, Hans De Backer<sup>1</sup>, Dirk Lauwers<sup>1</sup>, S.K. Jason Chang<sup>2</sup>

<sup>1</sup> Gent University, Faculty of Engineering and Architecture, Belgium

<sup>2</sup> National Taiwan University, Faculty of Engineering, Taiwan

### Abstract

Bicycle accidents have increasingly caused casualties and property damage. Many countries have therefore started to pay more attention to designing the space of bicycle paths. However, few studies have focused on the design of bicycle continuity between each bicycle path. In this study, the concept of using both spatial crash probability (P) and crash severity index (CSI) is introduced to address the bicycle safety issue on bridges in Central Business Districts (CBDs). Bicycle paths on bridges usually face design difficulties due to limited space, different altitudes and the amount of traffic volume. Therefore, a systematic process should be established to evaluate and implement cycling space on bridges. The characteristic of bicycle-motorized vehicle collisions (BMV), traffic engineering, road environment and driving behaviour are analysed through spatial negative binomial modelling (NB). It is the aim to give recommendations to city planners and governments concerning the enhancement of bicycle safety and riding continuity on bridges.

*Keywords: bridge, continuity, bicycle paths design, spatial negative binomial modelling (NB), crash severity index (CSI), bicycle-motorized vehicle collisions (BMV), and geographic information system (GIS)*

### 1 Introduction

Bicycle accidents have increasingly caused casualties and property damage. Many countries have started to pay more attention to the prevention of bicycle-motorized vehicle collisions (BMV). However, previously little research involved cycling traffic engineering due to insufficient on-road cycling monitoring systems among many developed countries. Comparing Taiwanese bicycle fatalities with other developed countries in 2013, the number of bicycle fatalities per million inhabitants was at 5.60% (NPA), that of the European Union (EU) was at 7.86% (ERSO), and that of the United States (US) was at 2.35% (NHTSA). The daily cycling usage rate in Taiwan was at 11.5% on average, that of the EU at 15.6%, and that of the US was at merely 0.4%. As can be seen, Taiwan has a relatively higher bicycle fatality rate compared with other developed countries. Thus, improving bicycle safety is a crucial issue in Taiwan. This research focuses on how to address the limited cycling space on bridges for urban commuting purposes, through traffic engineering design, with the aim to reduce and prevent the BMV collisions. In the Taipei metropolis, bridges had higher bicycle collision and injury severity rates than other roads. So far, few studies have given exact values about the way in which traffic engineering factors affect BMV accident frequencies and injury severities. Therefore, a spatial-GIS combined with temporal-probability modelling was established to understand the spatial and temporal patterns of BMV collisions on bridges, to evaluate bicycle spaces on bridges, and to make recommendations for cyclists and urban planners to enhance bicycle safety.

## 2 Data collection and processing

Establishing bicycle accident modelling involves a series of investigation steps, including: accident data collection, potential risk factor analysis, and the division between road segments and junctions. Additionally, the data processing procedure was divided into three steps: the first step was to obtain all bicycle collision data located in the Taipei metropolis between 2011 and 2013 from the Taiwan National Police Agency (NPA); the second step was to pinpoint bicycle black spots by recognizing their road environmental features from police accident reports, annual orthophotos and field investigation, Figure 1. The black spots were pinpointed by using GIS spatial clusters through kernel density estimation methods (Levine et al., 1995; Kim et al., 1995; NCCGIA, 2000; Schneider et al., 2002); the third step is to construct bicycle collision networks of the whole Taipei metropolis, to distinguish road segments and junctions from these networks, and to develop a BMV collision frequency and severity database.

An overview of the origin of all data sources considered is shown in Figure 2. As can be seen, the bicycle accident database in this research was developed because of the need to include the road environment of bicycle incident sites. The large amount of black spot data from the government institutions and our own field investigation was categorized into different road environment conditions. The categorization of the road environment consists of road environmental conditions, traffic engineering facilities and traffic control systems.

Although human factors and junctions were often considered as two of the main causes among most bicycle collisions, the location of bicycle incident sites may in fact be highly related to the geometric design and road environment on bridges as well. Improperly designed road segments or junctions on bridges may easily become potential conflict areas and cause BMV accidents. This research also shows that more than triple the number of BMV clashes occurred on road segments in comparison with the junctions on bridges(216/284). If the government invariably looks at the responsibility of road users for bicycle accidents, rather than also taking into account the road environment, it will be inevitable that similar BMV accidents reoccur.



**Figure 1** A three-year BMV collision database was created in this research. Each marked red point is a bicycle incident site located in the Taipei Metropolis between 2011 and 2013.

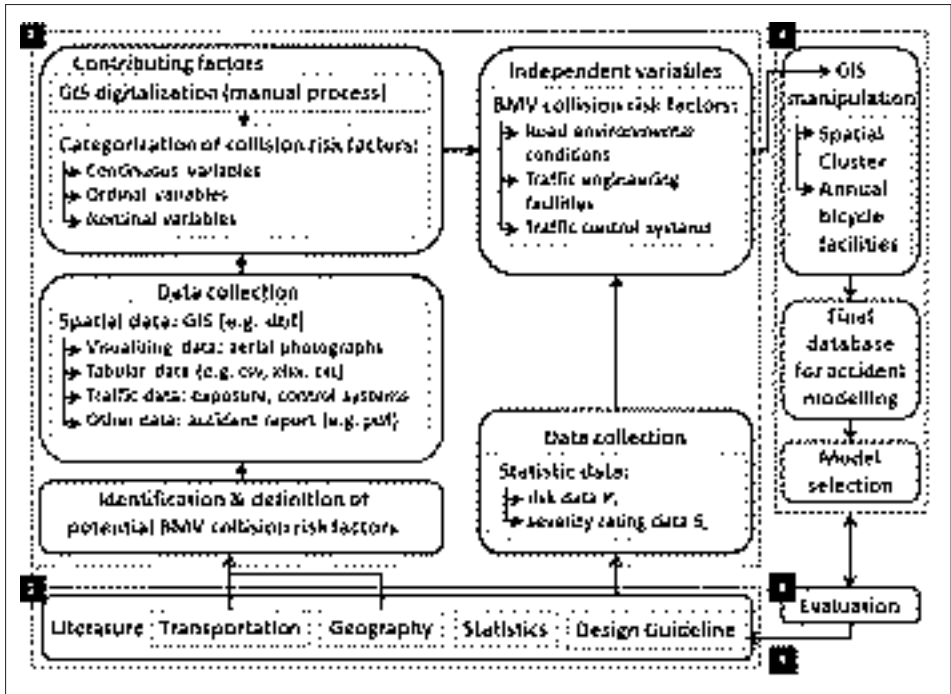


Figure 2 The Data collection and processing flow chart of bicycle collisions

The objective of this study is to understand the contributing factors between BMV collisions on bridges and road environment, geometric design, traffic engineering facilities, and traffic control facilities, and then to assess the level of impact of these factors on the reduction of the frequency and severity of BMV collisions on bridges. In order to understand the involved contributing factors of BMV accidents on bridges, the 41 factors being considered were divided into continuous variables, ordinal variables, and nominal variables. Some contributing factors were highly correlated, thus each pairs of dependent variables was first examined for its explanatory ability of the accident model, and the variables with less favourable explanation were then eliminated from the model.

### 3 Spatial negative binomial (NB) modelling

Firstly, each road was divided into several segments, Figure 3. Each junction collision site includes several forks, which are ten-meter buffers around each junction, Figure 4. For a given road segment or junction  $i$ , if the risk of involvement in bicycle accidents is  $P_i$ , then the number of bicycles may follow a binomial distribution, (Wang and Nihan, 2004) shown as Eqn (1). The probability with  $n_i$  bicycle accidents in the bridge segment or junction  $i$  is (1), where  $i$  is the section index;  $V_i$  is the traffic volume of section  $i$ ;  $n_i$  is the number of bicycle accidents associated with motorized vehicles at specific  $V_i$  traffic volume;  $P(n_i)$  is the probability with  $n_i$  bicycle accidents;  $P_i$  is the bicycle risk for motorized vehicles at  $V_i$  traffic volume. Comparing the bicycle risk  $P_i$  and traffic volume  $V_i$ , the value of  $P_i$  is very small since the number of bicycle accidents rarely exceeds the normal motorized vehicle volume. As a result, the Poisson regression model can explain the binomial distribution (Pitman, 1993) for bicycle accidents analysis and estimation. Moreover, Eqn (1) can be approximated by Eqn (2). The distribution parameter of the Poisson regression can then be presented in Eqn (3), where  $E(n_i)$  is the expected value of  $n_i$ .





Figure 3 Each road divided into several sections, mutually corresponding to different geometric configurations of the road segment

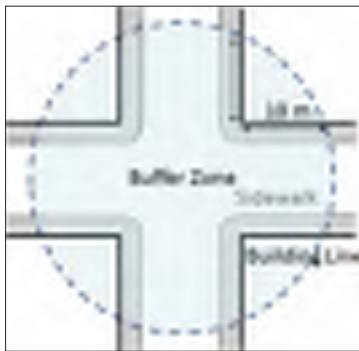


Figure 4 Definition of a junction: ten-meter buffers from the corner of building lines

$$P(n_i) = \binom{V_i}{n_i} P_i^{n_i} (1 - P_i)^{V_i - n_i} \quad (1)$$

$$P(n_i) = \frac{\mu_i^{n_i} e^{-\mu_i}}{n_i!} \quad (2)$$

$$\mu_i = E(n_i) = V_i P_i \quad (3)$$

$$\ln \mu_i = \ln(V_i P_i) + \varepsilon_i \quad (4)$$

$$P(n_i | \varepsilon_i) = \frac{(V_i P_i e^{\varepsilon_i})^{n_i} e^{-V_i P_i e^{\varepsilon_i}}}{n_i!} \quad (5)$$

$$P(n_i | \varepsilon_i) = \frac{\prod (n_i + \theta)}{\prod (n_i + 1) \prod (\theta)} \left( \frac{\theta}{V_i P_i + \theta} \right)^\theta \left( \frac{V_i P_i}{V_i P_i + \theta} \right)^{n_i} \quad (6)$$

$$V(n_i) = E(n_i) = [1 + \delta E(n_i)] \quad (7)$$

$$P_i = \frac{F_i}{F_i + e^{-\beta_i X_i}} \quad (8)$$

$$S(n_i) = \binom{V_i}{n_i} S_i^{n_i} (1 - S_i)^{V_i - n_i} \quad (9)$$

$$S_i = P_i (EPDO)_i = P_{iA_3} + 27.8P_{iA_2} + 45.9P_{iA_1} \quad (10)$$

A Poisson regression with non-negative, discrete and random properties is often applied to accident prediction. However, this regression method requires that the Poisson distribution's expected value (mean value) is equal to its variance. In many cases, as with this study, the Poisson model is considerably restricted by this constraint, because the accident data have to be over-dispersed to match this constraint. By changing Eqn (3) into the log transformation, adding an independent distribution error  $\epsilon_i$  in Eqn (3), Eqn (4) can be shown as follows: Next,  $e^{\epsilon_i}$  is assumed to follow a Gamma distribution, i.e. equal to 1, variance given to  $\delta$ , and  $\theta = 1/\delta$ . Furthermore, putting Eqn (4) into Eqn (2) can be presented as Eqn (5), and a negative binomial regression model can be derived as Eqn (6). Thus, the expected values of the NB and the Poisson regression model still remain the same, and its variance is shown in Eqn (7). The NB distribution will be adopted in this bicycle accident model, if  $\theta$  is at a significant level. Otherwise, the Poisson distribution will be more suitable than the NB distribution.  $P_i$ , the bicycle accident risk for an assumed bicycle volume  $F_i$  and a series of explanatory factors, can be shown as Eqn (8).  $F_i$  is based on the estimation of cycling population of this area by field investigating the number of bicycle riders.  $\beta_i$  is a set of coefficients, and  $X_i$  is a set of contributing factors in section  $i$ .

This model has three advantages. Firstly, the bicycle accident risk approximates 0 where there is little bicycle volume at the junctions or the road segments. Secondly,  $\beta_i$  indicates an increasing or decreasing effect on the bicycle accident risk. Finally, the severity ranking procedure was developed to assess the severity of each accident location by following two fundamental methodologies.  $S(n_i)$  is the severity probability with  $n_i$  bicycle accidents, introduced as Eqn (9) into the original NB modelling to replace  $P_i$ . The severity  $S_i$  finally can be derived as Eqn (10) and  $P_{iA_1}$ ,  $P_{iA_2}$ ,  $P_{iA_3}$  are the respective bicycle risk based on the accident severity for motorized vehicles at  $V_i$  traffic volume.

**Table 1** Contributing factors with continuous variables, listed significant only.

Contributing factors	mean	Standard deviation	Minimum	Maximum
speed limit $X_{13}$ (km/hr.)	52.48	9.226	20	70
daily bicycle volume $F_i$ (in 1000)	0.393	0.589	0.048	5.891
daily traffic volume $X_{15}$ (in 1000)	18.566	9.446	14.066	139.962
numbers of lanes (unidirectional) $X_{134}$	2.9200	1.43	1	9
width of sidewalk $X_{135}$ (m)	1.29	1.64	0	10.22
width of the lane at the accident location $X_{136}$ (m)	3.50	2.72	0	34.00
areas of a junction $X_{137}$ (in 100 m <sup>2</sup> )	3.0604	6.7928	0	39.76

**Table 2** Contributing factors with ordinal variables, listed significant only.

road environmental conditions	the value and frequency of observed variables				
	0	1	2	3	4
speed limit $X_{13}$	19(6.7)	5(1.8)	77(27.1)	183(64.4)	0(0.0)
traffic engineering facilities	the value and frequency of observed variables				
	0	1	2	3	4
lane types $X_{115}$	114(40.1)	6(2.1)	22(7.7)	54(19.0)	88(31.0)
obstacles $X_{122}$	264(93.0)	20(7.0)			
bidirectional overtaking-prohibited marking $X_{125}$	238(83.8)	23(8.1)	23(8.1)		
unidirectional overtaking-prohibited marking $X_{126}$	280(98.6)	1(0.4)	3(1.4)		
divisional facilities $X_{128}$	53(18.7)	231(81.3)			
lane changing-prohibited facilities $X_{130}$	270(95.1)	10(3.5)	4(1.4)		
traffic control systems	the value and frequency of observed variables				
	0	1	2	3	4
signalized facilities $X_{138}$	203(71.5)	9(3.2)	40(14.1)	32(11.3)	
timing (sec) $X_{140}$	873(42.7)	618(30.2)	553(27.1)		

**Table 3** The correlation test of contributing factors, listed significant only

Contributing factor	Variables (eliminated)	Correlation
lane types $X_{115}$	priority lanes $X_{i16}$	0.766
signalized facilities $X_{138}$	the condition of signalized facilities $X_{i39}$	0.782
timing (sec) $X_{140}$	signal phase $X_{i41}$	0.869

## 4 Results

In this spatial bicycle accident model,  $X_i$  is a set of contributing factors, which may affect the accident risk and severity on bridges. By using the maximum likelihood estimation (MLE) approach, estimated coefficients ( $\beta_j$ ) of these factors can be obtained. After running the estimated procedures through the software limdep 9.0, the spatial negative binomial modelling at the significance levels of 99.9% is superior to and therefore replaces the Poisson model. This result confirms that the spatial NB modelling is more suitable to assess the risks and severities of bicycle accidents in Taipei metropolis. Excluding collinear problems, 36 variables remain in the final risk model. The estimated coefficients and their significance levels (P-value) are presented in Table 5. The value of factors shows the comparative risk level of holistic NB modelling. It also shows that approximately one half of the contributing factors are significant in this model, giving a fitted classification under the model.

## 5 Discussions and recommendations

Evaluating accident risks with special-temporal methods is much more useful than those with conventional blind spot methods, since spatial NB modelling can calculate the potential accident risk at each location within the whole bridge road network. Based on traffic volume, lane types, and road pavement materials, accident risks can be estimated at those unreported locations. On the other hand, blind spot methods only provide the risk value of recorded locations, but cannot estimate possible existing risks of unrecorded locations of bicycle-motorized vehicle collisions. Moreover, blind spot methods do not take the construction period of transportation facilities into consideration (Vandenbulcke, Thomas et al., 2014). Some research locations were dangerous in the past, but during the research period, the transport

facilities have already been implemented or changed. Blind spot methods also do not take periodic traffic volumes and directional traffic volumes into account. They usually indicate only bidirectional traffic volumes, and identify how it affects riding safety at both sides of the road. In fact, many blind spots were concentrated at one side of the road. Using blind spot methods may lead to misguided analysis and propose mistaken suggestions toward existing traffic facilities on bridges.

**Table 4** The list of variables and contributing factors of spatial NB modelling, listed significant only

variables	definition of categories	data source	references
road networks		annual ArchGIS road networks from Department of Urban Development, Taipei city Government	Haleem and Abdel-Aty, 2010
BMV accident in location $i$	$i=1\sim 4018$ , 284 samples are observed on bridges	annual collision site figures from Taipei Metropolis Police Department and Taiwan National Police Agency (NPA)	
frequencies of BMV accidents in location $i$	1~25	clusters though kernel density estimation methods, original datasets from annual collision site figures	Levine et al., 1995; Kim et al., 1995; NCCGIA, 2000; Schneider et al., 2002
The estimation of accident costs in the Taipei Metropolis	A1=568,413, A2=344,490, A3=12,384(USD)	Department of Transportation Taipei City Government (DOT), 2003 and 2015	Haleem and Abdel-Aty, 2010
annual GPD of Taiwan		annual GDP report from Statistics from Statistical Bureau, Taiwan	
crash severity index (CSI)	A1=fatality, A2=injury, A3=property damage	National Road Traffic Safety Commission (NRTSC)	Vorko-Jović et al., 2006; Daniels et al., 2009
daily bicycle volume $F_i$	48~5891	field investigation from this research, and road sensor data from Taipei City Traffic Engineering Office	Wang and Nihan, 2004
<b>contributing factors</b>			
daily traffic volume $X_{15}$	14066~139962	Road sensor data, from Taipei City Traffic Engineering Office	Sando et al., 2005; Daniels et al., 2009
speed limits (km/hr.) $X_{13}$	20~70	tables from Taipei City Traffic Engineering Office Traffic Control Center	Räsänen et al., 1999; Wang and Nihan, 2004; Vorko-Jović et al., 2006; Abdel-Aty et al., 2007; Haleem and Abdel-Aty, 2010
minimum sight distance (m)	0=unlimited(>30), 1=16~30, 2=1~15m	annual collision site figures from Taipei Metropolis Police Department	Blomberg et al., 1986
width of the road (m) $X_{112}$	10.2~44.5	annual datasets of facilities measured by AutoCAD software, which received from Ministry of the Interior in Taipei	Daniels et al., 2009
the number of road forks $X_{17}$	0=road segment, 1=T-road with 3 forks, 2=intersection with 4 forks, 3=junction with 5 forks, 4= junction with more than 5 forks		Haleem and Abdel-Aty, 2010
lane types $X_{115}$	0=no lane categories, 1=the accident occurred within the lane of fast transport modes, 2=of slow transport modes, 3=of mixed transport modes, 4=within the priority lane of certain vehicles		Rodgers, 1997; Daniels et al., 2009

**Table 4** The list of variables and contributing factors of spatial NB modelling, listed significant only (cont.)

variables	definition of categories	data source	references
Priority lanes $X_{116}$	0=no priority lane, 1=lane exclusively for buses, 2=lane exclusively for scooters and motorcycles, 3=path for motorcycle priority		Rodgers, 1997; Räsänen et al., 1999; Abdel-Aty et al., 2007; Daniels et al., 2009
paving materials $X_{119}$	0=no paving materials, 1=asphalt (soft pavement), 2=concrete with steels (rigid pavement) , 3=bricks with rigid pavement;		Haleem and Abdel-Aty, 2010
bidirectional overtaking-prohibited marking $X_{125}$	0 = without marking, 1 = marking, 2= marking with protruding flickers on the ground		Blomberg et al., 1986
unidirectional overtaking-prohibited marking $X_{126}$	0=without marking, 1=marking, 2=marking with protruding flickers on the ground		Blomberg et al., 1986
divisional facilities $X_{128}$	0=no divisional facilities, otherwise=1		Daniels et al., 2009
lane changing-prohibited facilities $X_{130}$	0=no, 1=the location with lane changing-prohibited marking, 2=the location with both lane changing marking-prohibited and physical facilities (e.g. protruding flickers on the ground)		
width of dividers for fast and slow traffic modes (m) $X_{131}$			Daniels et al., 2009
slow lane marking			Hunter et al., 1997; Räsänen et al., 1999
curb marking			Hunter et al., 1997; Räsänen et al., 1999
number of lanes (unidirectional)			Sando et al., 2005; Abdel-Aty et al., 2007; Daniels et al., 2009
<b>area of junctions (m<sup>2</sup>)</b>			
signalized facilities / the condition of signalized facilities	0=no, otherwise=1		Preusser et al., 1982; Hunter et al., 1997; Daniels et al., 2009
Timing (hr.) / signal phrase (sec) $X_{141}$	0~24 / 0= 0~60, 1= 61~120, 2 = >120 sec		Blomberg et al., 1986; Rodgers, 1997
maneuver of motorists	0=straight, 1=left-, 2=right-turning		Preusser et al., 1982; Daniels et al., 2009
maneuver of cyclists	0=straight, 1=left-, 2=right-turning		Räsänen et al., 1999; Daniels et al., 2009

**Table 5** The result of spatial negative binomial modelling (grey = not significant)

risk of BMV accident spatial negative binomial modelling	frequencies		severity	
	coefficient	P-value	coefficient	P-value
consistent	-0.3531	0.8090	5.1253	0.0000**
<b>road environmental conditions</b>				
daily traffic volume (exposure)	0.0711	0.0560	0.4966	0.0640
speed limits (km/hr.)	-0.2031	0.0610	0.1141	0.0129*
minimum sight distance	0.4977	0.2014	0.4438	0.0007***
<b>traffic engineering facilities</b>				
lane types (priority lane)	0.2778	0.0000***	0.3196	0.0000***
paving materials	-0.7736	0.0315*	-0.7611	0.1425
bidirectional overtaking-prohibited marking	0.4849	0.0029**	0.4705	0.0047**
unidirectional overtaking-prohibited marking	0.8849	0.0124*	0.8845	0.0453*
divisional facilities	-0.4957	0.0402*	-0.4757	0.0461*
lane changing-prohibited facilities	-0.6727	0.0158*	-0.7785	0.0075**
width of dividers for fast and slow traffic modes	0.1223	0.1610	0.1703	0.0513
number of lanes (unidirectional)	0.3020	0.0000***	0.3428	0.0000***
width of the lane at the accident location $i$ (m)	-0.0545	0.0137*	-0.0700	0.0010***
area of junctions ( $m^2$ )	0.0002	0.0000**	0.0002	0.1094
<b>traffic control systems</b>				
signalized facilities (the condition of signalized facilities)	-0.2093	0.0976	-0.2868	0.0179*
signal phrase (sec) (signal phase)	0.1633	0.0378*	0.1641	0.0348*
Alpha	0.4396	0.0000***	0.4729	0.0000***

\* Significant at 95% \*\* Significant at 99% \*\*\*Significant at 99.9%

## 5.1 Road environmental conditions

The result shows that the occurrence of traffic volume is not sensitive to the possibility of BMV conflicts on bridges. The increasing number of BMV conflicts might result from the increasing traffic volume. However, the results reveal that coefficients associated with daily traffic volume are not significant. These results may suggest that road users usually decelerate under higher traffic volume, such as during the peak hour, thus reducing the influence of the traffic volume in CBDs, consistent with previous findings (Wang et al., 2004). The study demonstrates that travelling under higher speed or under shorter sight distance, might not directly cause more BMV accidents. However, these factors may significantly increase the severity of BMV accidents, thus vehicles on bridges located in the CBDs are supposed to lower their speed limit to 50 km/hr, and cyclists are supposed to maintain their safety sight distance of at least longer than 30 meters.

## 5.2 Traffic engineering facilities

Traffic engineering facilities significantly influence the frequency and severity of BMV accidents. These risks may be caused by the type of lane. In the Taipei Metropolis, the majority of lanes on bridges are related to the heterogeneity of traffic velocities. Due to mixed traffic with heterogeneous vehicular velocities, lanes for mixed transport modes are riskier than those for only low and fast transport modes. However, dedicated lanes exclusively for buses or motorcycles significantly increase the risk of BMV collisions on bridges. This is caused by the trespassing of cyclists. Paths prioritizing motorcyclists are even riskier than the dedicated

lanes because of much more potential conflicts between motorized vehicles and cyclists. Protective and divided bicycle facilities may greatly reduce BMV accident risks and also prevent potential BMV collisions enhancing road safety.

The way of paving influences cycling collision rates (coefficient =  $-0.7736$ ). Firstly, asphalt pavement may lower BMV accident rate. However, maintaining the material quality itself is difficult, due to the fact that it is highly sensitive to weather or external forces, causing different levels of damage, such as deformation and cracks. In contrast, rigid pavement, consisting of binding steel with slabs of Portland concrete, may greatly reduce the BMV collisions. Although it diminishes the riding speed and comfort of cyclists, it relatively improves their riding safeness. Also, a base of rigid pavement covered with cobble stones or bricks as an upper layer may reduce BMV collisions more than with only the base layer. This kind of paving may simultaneously lower not only the driving velocities but also the whole speed gap between cyclists and motorists, thus highly improving the safety of cyclists.

Illegal overtaking raises BMV accident frequencies and severities (coefficient =  $0.8849$ ,  $0.8845$ ). For instance, blind spots are located where there are uni- or bidirectional overtaking-prohibited paths on bridges. Because of low cycling speed, the rear motorized vehicles easily overtake aggressively, resulting in an increased risk. This study also shows that three out of four conflicts in these locations were improper lateral crashes; the minority were rear and frontal crashes. In contrast, lane changing-prohibited facilities and divisional facilities (i.e. channelizing) decreases the number and severity of bicycle accidents (coefficient =  $-0.6727$ ,  $-0.7785$  and  $-0.4957$ ,  $-0.4757$  respectively). This decrease of accidents may be attributable to the reduced BMV conflicts. Appropriate remedial measures to the bridge infrastructure, such as reallocating a cycling path on the pedestrian path, widening of the pedestrian path for cycle use, narrowing the lane of motorized vehicles to avoid illegal overtaking, applying lane changing-prohibited facilities, or a well-thought implementation of separated cycle path, minimize the bicycle accident frequency and injury severity.

The dimension of traffic engineering facilities significantly influences accident risks. These risks may result from the increased size of road junctions. In Taipei, junctions with the increased size usually face the complexity of traffic situations, such as speed differentials between bicycles and motorized vehicles, complex traffic composition, and mass traffic volumes, thus increasing the likelihood of bicycle risks. Additionally, lanes may be related to the complexity of traffic situations, such as a road with more numbers of lanes, which is riskier than a normal road.

However, the increased width of lanes may lower accident risks. The result shows that few blind spots are located at wider lanes. Because of the wider lanes, the visibility is enhanced, resulting in a decreased risk. Moreover, a wider width of the lane decreases potential bicycle conflicts with motorized vehicles. This decrease of conflicts may be attributable to the highly strong impact of raised space on driver reaction times. Appropriate remedial measures to the bridge infrastructure, such as widening of the lanes and reducing the number of the lanes may provide more reaction time for the road users, thus minimizing the bicycle accident risk. However, in some cases, the widening of the lanes cannot be done practically?????. Designing ancillary bicycle paths combined with pedestrian paths may also reduce bicycle collisions during the mixed traffic situation.

The increased width of dividers for fast and slow traffic modes only leads to higher crash severity (coefficient =  $0.1703$ ). In Taipei, most physical dividers are usually made of hard materials. Soft materials may be covered on them as mitigation design for cyclists.

### 5.3 Traffic control systems

Finally, crashes that involve cyclists may be associated with traffic control facilities. The presence of signalized facilities, which lowers vehicular speeds, decreases the severity of bicycle conflicts. It is also recommended that particular traffic signals for cyclists, such as cyclist or

pedestrian signals, are provided to avoid potential bicycle-motorized vehicle conflicts, thus enhancing road safety.

The longer phase of signalized facilities (i.e. >120 sec per cycle phase of red/amber/green lights for both motorized cycling phase together), may also induce a high accident risk. In Taiwan, long phases mainly occur during off-peak hours. Aggressive driving behaviour, such as accelerating travelling speeds, randomly changing lanes and violating road markings, may easily happen. It is therefore important to properly shorten signalized phases (control travelling speeds) to prevent aggressive driving behaviour, thus reducing bicycle accidents.

## References

- [1] Wachtel, A., and Lewiston, D.: Risk Factors for Bicycle-Motor Vehicle Collisions at Intersections, *Journal of Safety Research*, vol. 27, no. 3, pp. 195, Autumn, 1996.
- [2] Vorko-Jovič, A., Kern, J., Biloglav, Z.: Risk Factors in Urban Road Traffic Accidents, *Journal of Safety Research*, vol. 37, no. 1, pp. 93-98, 2006.
- [3] Sando, T., Mussa, R., Sobanjo, J., et al.: Advantages and Disadvantages of Different Crash Modeling Techniques, *Journal of Safety Research*, vol. 36, no. 5, pp. 485-487, 2005.
- [4] Rodgers, G.B.: Factors Associated with the Crash Risk of Adult Bicyclists, *Journal of Safety Research*, vol. 28, no. 4, pp. 233-241, Winter, 1997.
- [5] Richard D. Blomberg, A.H., Preusser, D.F.: Experimental Evaluation of Alternative Conspicuity Enhancement Techniques for Pedestrians and Bicyclists, *Journal of Safety Research*, vol. 17, no. 4, pp. 193-195, Winter, 1986.
- [6] Räsänen, M., Koivisto, I., Summala, H.: Car Driver and Bicyclist Behavior at Bicycle Crossings under Different Priority Regulations, *Journal of Safety Research*, vol. 30, no. 1, pp. 67-77, Spring, 1999.
- [7] Preusser, D.F., Leaf, W.A., DeBartolo, K.B., et al.: The Effect of Right-Turn-on-Red on Pedestrian and Bicyclist Accidents, *Journal of Safety Research*, vol. 13, no. 2, pp. 45-55, Summer, 1982.
- [8] Haleem, K., Abdel-Aty, M.: Examining Traffic Crash Injury Severity at Unsignalized Intersections, *Journal of Safety Research*, vol. 41, no. 4, pp. 347-357, 8, 2010.
- [9] Godthelp, J., Wouters, P.I.: Course Holding by Cyclists and Moped Riders : J. Godthelp and P.I. Wouters, *Applied Ergonomics*, 1980, 11(4), 227–235, *Journal of Safety Research*, vol. 13, no. 4, pp. 178, Winter, 1982.
- [10] Daniels, S., Brijs, T., Nuyts, E., et al.: Injury Crashes with Bicyclists at Roundabouts: Influence of Some Location Characteristics and the Design of Cycle Facilities, *Journal of Safety Research*, vol. 40, no. 2, pp. 141-148, 2009.
- [11] Abdel-Aty, M., Chundi, S.S., Lee, C.: Geo-Spatial and Log-Linear Analysis of Pedestrian and Bicyclist Crashes Involving School-Aged Children, *Journal of Safety Research*, vol. 38, no. 5, pp. 571-579, 2007.
- [12] Wang, Y., Nihan, N.L.: Estimating the Risk of Collisions between Bicycles and Motor Vehicles at Signalized Intersections, *Accident Analysis & Prevention*, vol. 36, no. 3, pp. 313-321, 5, 2004.
- [13] Vandenbulcke, G., Thomas, I., Int Panis, L.: Predicting Cycling Accident Risk in Brussels: A Spatial Case–Control Approach, *Accident Analysis & Prevention*, vol. 62, no. 0, pp. 341-357, 1, 2014.
- [14] Schepers, J.P., Kroeze, P.A., Sweers, W., et al.: Road Factors and Bicycle–Motor Vehicle Crashes at Unsignalized Priority Intersections, *Accident Analysis & Prevention*, vol. 43, no. 3, pp. 853-861, 5, 2011.
- [15] Verkeerspolitie, “Antwerp Police Annual Report,” P. Antwerpen, ed., 2013, pp. 1-75, 2013
- [16] Vandenbulcke-Plasschaert, G.: “Spatial Analysis of Bicycle Use and Accident Risks for Cyclists,” 2011.
- [17] Steenaert, C., Overkamp, D., Kranenburg, A: Bestaat De Ideale 30 Km/H-Wijk? : Evaluatie Van Twintig Sober Duurzaam Veilig Ingerichte 30 Km/H-Gebieden, Adviesdienst Verkeer en Vervoer, Rotterdam, Ministerie van Verkeer en Waterstaat, 2004.



- [18] Research, I. f. r. s., Swov Fact Sheet, no. Leidschendam, the Netherlands, pp. 1-5, 2013.
- [19] Observatory, E. R. S.: Traffic Safety Basic Facts 2012 Cyclists, vol. Cyclists, the European Commission, 2012.
- [20] Hunter, W.W., Pein, W.E., Stutts, J.C.: "Bicycle-Motor Vehicle Crash Types: The Early 1990s," U. S. D. o. Transportation, ed., 1997.
- [21] CROW, "Sobere Inrichting Van 30-En 60 Km/H-Gebieden : Een Illustratieve Aanpak Met Praktijkvoorbeelden," Infopunt Duurzaam Veilig Verkeer, 2000, pp. 1-34, 2000
- [22] Council, E. T. S., Making Walking and Cycling on Europe's Roads Safer, pp. 1-44, 2015.
- [23] ArcGIS 9.3 <http://webhelp.esri.com/arcgisdesktop/9.3/index.cfm?TopicName=welcome>
- [24] Limdep 9.0 <http://www.limdep.com/features/capabilities/>
- [25] Annual GDP of Taiwan <http://eng.stat.gov.tw/point.asp?index=1>



## ANALYSIS OF SIGHT DISTANCE AT AN AT-GRADE INTERSECTION

Ivana Pranjić<sup>1</sup>, Aleksandra Deluka-Tibljaš<sup>1</sup>, Dražen Cvitanić<sup>2</sup>, Sanja Šurdonja<sup>1</sup>

<sup>1</sup> University of Rijeka, Faculty of Civil Engineering

<sup>2</sup> University of Split, Faculty of Civil Engineering, Architecture and Geodesy

### Abstract

Maneuvering distance and stopping sight distance are important traffic safety elements at an at-grade intersection. Croatian official standard for sight distance calculation (HRN.U.C4.050) dates from 1990. This regulation treats sight distance values in a very simplified way. The mentioned regulation seems to be outdated since various researches of real traffic conditions at an at-grade intersection have been conducted to detect significant factors influencing sight distance. In this paper an overview of sight distance calculation methods according to Croatian official standard (HRN.U.C4.050), and additionally according to Croatian guidelines for urban intersection design from the traffic safety aspect (Hrvatske ceste, 2004.), American guidelines for geometric design of highways and streets – The Greenbook (AASHTO, 2001.) and PIARC Road Safety Manual (2003.) is done. These calculation methods were applied at an at-grade intersection in City of Rijeka, where necessary calculation parameters (vehicle speed, friction coefficient) were collected at the site. This intersection is distinctive for greater amount of traffic accidents due to lack of maneuvering and stopping sight distance. The conducted analysis of different sight distance calculation methods shows that inspected calculation methods differ for calculation parameters and consequently given sight distance values. The sight distances obtained with suggested calculations from Croatian standard are in all cases less conservative than the sight distances calculated with other, more detailed methods. This is why a revision of current Croatian regulations concerning sight distance is suggested.

*Keywords: sight distance, at-grade intersection, calculation models*

### 1 Introduction

Sight distance is an important element of traffic safety especially at non-signalised intersections. Insufficient sight distance often represents one of major causes of traffic accidents resulting in property damages but also more or less severe road users injuries. At intersections, the available sight distance must be sufficient to allow users to safely complete each permitted but non-priority manoeuvre [1]. Various intersection types and right-of-way rules determine sight distance criteria needed to ensure safety requirements for all motorised road users. One of the major factors that influence sight distance is traffic speed on major and minor roads. Systematic measurement and analysis conducted in Ireland in the period between 2005. and 2011. demonstrate that 82% of car drivers surveyed exceeded the 50 km/h limit on national roads in urban areas and 53% of these drivers exceeded the speed limit by 10 km/h or more [2]. The traffic safety data collected and published by Croatian Ministry of Internal Affairs show that in 2012 [3] 74% of all road traffic accidents happened in urban areas and more than 31% happened in the intersection area. It is even more interesting that 34% of all accidents were connected with turning manoeuvres or happened as vehicle impact from the back, where

the reasons for these types of accidents could easily be addressed to problems of exceeded speed and insufficient sight distance for safely vehicle stopping.

In this paper an overview of sight distance calculation method according to Croatian official standard HRN.U.C4.050 (further in the text Croatian standard) [4] is done. Croatian standard dates from 1990. and has some limitations in comparison with widely used methods because it is based on limited number of parameters which are assumed on theoretical basis without their adjustment to local conditions or without being explicitly measured on site [5]. Croatian guidelines for urban intersection design from the traffic safety aspect (further in the text Croatian Guidelines) [6] were also analyzed from the sight distance aspect and compared with the official Croatian standard. The sight distance calculation methods according to American guidelines for geometric design of highways and streets – The Greenbook (AASHTO, 2001.) (further in the text The Greenbook) [7] and PIARC Road Safety Manual (PIARC, 2003.) (further in the text RSM) [1] were analyzed and compared to given Croatian legislative and recommendations.

These calculation methods were applied, as a case study [8], at an at-grade intersection in City of Rijeka in order to compare the results of different methods and make conclusion about suitability of Croatian Standard after 25 years of use without any serious revision. In this case study necessary calculation parameters, such as vehicle speed and friction coefficient, were collected at the intersection site to compare values calculated with those data with usually used theoretical values and to establish their influence on final results. The conclusions of the case study are explained in the paper too.

## 2 Sight distance calculation methods

Sight distance calculation methods differ regarding parameters on which they are based. Main parameters that can be found in all of methods are vehicle speed (design speed or actual 85<sup>th</sup> percentile speed) and time interval needed to perform a certain turning manoeuvre or to stop the vehicle before hitting an obstacle. In this chapter an overview of calculation methods according to Croatian standards and Croatian guidelines [4],[6] and some foreign sight distance calculation standards methods [1], [7] is done.

### 2.1 Manoeuvring distance calculation methods

Manoeuvring distance refers to sufficient sight distance needed for safe completion of all permitted but non-priority manoeuvres at an at – grade intersection, which includes right turn, crossing or left turn from minor road and left turn from major road [1].

Croatian standard from 1990 is based on presupposing driver's reaction time and acceleration. The Standard considers difference between intersections with obligatory stops on minor road and yield intersections. The left picture in Figure 1. and Equation (1) refer to sight distance at intersections with stops, while right picture in Figure 1. and Equation (2) refer to sight distance on yield intersections.

$$P_g = v_g t_s = v_g \left( t_r + \sqrt{\frac{2D}{a_s}} \right) \quad (1)$$

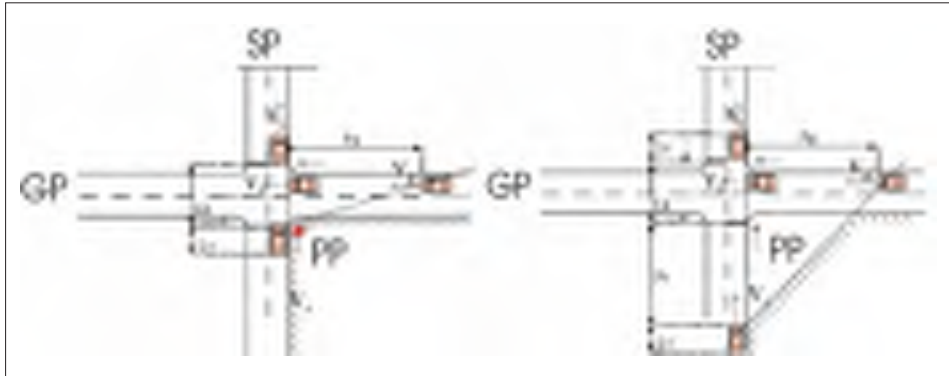
Where:

- $P_g$  – sight distance on major road;
- $v_g$  – design speed on major road (km/h);
- $t_r$  – reaction time (s),  $t_r = 1,5$  s;
- $D$  – crossing intersection length,  $D = L_k + L_v$ ;
- $L_k$  – distance between two opposite intersection legs;
- $L_v$  – vehicle length (approx. 6 m);
- $a_s$  – acceleration rate for PV,  $a_s = 1,5$  m/s<sup>2</sup>.

$$P_s = v_s t_r + \frac{v_s^2}{2g \left( f_t \pm \frac{i}{100} \right)} \quad (2)$$

Where:

- $P_s$  – sight distance on minor road;
- $v_s$  – design speed on minor road (km/h);
- $t_r$  – reaction time (s),  $t_r = 1,5$  s;
- $f_t$  – tangential friction coefficient on minor road;
- $i$  – vertical slope (%) of minor road.



**Figure 1** Sight distance for obligatory stop on minor road (left) and yield intersection (right); Croatian standard [4]

The previous research from Cvitančić et al. [5] pointed out few deficiencies of the Standard: exclusion of the necessary manoeuvring time for left or right turn but giving only time necessary for crossing the intersection, inclusion of the unnecessary part of  $L_k$  width from the edge of the carriageway to the STOP line on the outbound intersection leg, and also usage of the projected speed  $v_r$  of minor road for calculating sight distance on yield intersections which is unrealistic because vehicle decelerates when approaching the intersection.

Another Croatian document that deals with sight distance issues is Guidelines for urban intersection design from the traffic safety aspect dating from 2004 [6]. The Guidelines give some recommendations for necessary sight distance according to  $v_{85}$  speed without explaining its usage, but simply recommending certain values. For example, recommended sight distance value at intersection with  $v_{85} = 60$  km/h as 85<sup>th</sup> percentile of speed on major road is 85 m [6]. Since the Croatian sight distance calculation methods exclude time intervals necessary for turning manoeuvres or presuppose sight distance according to approaching vehicle speed, the chosen foreign standards for comparison were AASHTO's Greenbook [7] and PIARC's RSM [1] which both include necessary time intervals for different turning manoeuvres, while PIARC's RSM also takes into consideration the real vehicle speed on intersection.

The Greenbook [7] gives a calculating expression (Equation 3) very similar to one from the Croatian standard (Eq.1) with the main difference of including different time intervals necessary for different turning manoeuvres. These time intervals (expressed in seconds) are given in Table 1. for different vehicle types. Their adjustment is necessary for minor road's vertical slope greater than 3% and for each extra passing lane [5]. This standard adopts road design speed for sight distance calculation, which can be disadvantage in cases where actual speed is much greater than the design speed.

$$P_g = 0,278v_g t_g \quad (3)$$

Where:

$P_g$  – sight distance;

$v_g$  – design speed (km/h);

$t_g$  – time interval (depending on manoeuvre type).

**Table 1** Time intervals for different turning manoeuvres, The Greenbook [7]

MANOEUVERE	PV	HV	HV + trailer
Left turn	7,5 s	9,5 s	11,5 s
Right turn/ Crossing	6,5 s	8,5 s	10,5 s
Left turn from major road	5,5 s	6,5 s	7,5 s

The main difference between PIARC's [1] and AASHTO's [7] calculation is the speed considered for sights distance calculation. PIARC's RSM considers  $v_{85}$  speed, or 85<sup>th</sup> percentile of speed on major road, which is much more realistic than design which is taken into consideration in both Croatian and US Standard methods. The RSM also gives some manoeuvring gaps or time intervals for different countries, which are shown in Table 2.

$$D = \frac{v_{85}t}{3,6} \quad (4)$$

Where:

D – sight distance (m);

$v_{85}$  – 85<sup>th</sup> percentile of speed on major road (km/h);

t – manoeuvring gap (s).

**Table 2** Manoeuvring gaps for different countries, PIARC's RSM [1]

COUNTRY	MANOEUVRING GAP for PV
France/Spain	6-8 s
England	5-8 s
USA	6,5-7,5 s

After calculating or adopting sight distance values according to requirements of chosen calculation method it is necessary to check the sight triangles, which represent areas inside intersection zone where no obstacle should be present.

## 2.2 Stopping sight distance calculation methods

Stopping sight distance represents available sight distance which must be sufficient for the driver to safely stop the vehicle when approaching an intersection at a reasonable driving speed ( $v_{85}$ ) [1]. Croatian legislative gives no distinctive regulation for stopping sight distance calculation on major road. The above mentioned Croatian standard for sight distance calculation on intersections with stops on minor road considers only sight distance for major roads when crossing the intersection, when the vehicle from minor road has already stopped. The Guidelines have some recommendations for necessary stopping sight distance on roads according to road category, 85<sup>th</sup> percentile of approach speed and vertical slope, but without any explanation when to apply minimum or maximum value from the given range [6]. For example, for roads in urban areas with 85<sup>th</sup> percentile speed of 50 km/h recommended stop-

ping sight distance ranges from 40 to 50 m, which is a significant length in terms of stopping sight distance (10 m equals almost two vehicle lengths).

The Greenbook recommends calculating stopping sight distance as the sum of the distance traversed during the brake reaction time and the distance to brake the vehicle to stop (Equation 5) [7]. This formula includes design speed  $v_g$ , but also adopted values of presupposed brake reaction time  $t_r = 2.5$  s and deceleration rate  $a = 3.4$  m/s<sup>2</sup> (Eq. 5) derived from previously conducted studies.

$$SSD = 0,278v_g t_r + 0,039 \frac{v_g^2}{a} \quad (5)$$

PIARC's RSM gives stopping sight distance calculating expressions in two forms, once including longitudinal friction coefficient  $f_l$  based on approaching speed (Equation 6) and once including the same deceleration rate as The Greenbook (Equation 7) [1]. It also includes initial speed  $v_i$ , or 85<sup>th</sup> percentile of approaching vehicle speed. The reaction time and longitudinal friction coefficient are not strictly defined values, but lie within typical values intervals [1].

$$SSD = \frac{v_{85} t_r}{3,6} + \frac{v_{85}^2}{254 \left( f_l \pm \frac{G}{100} \right)} \quad (6)$$

$$SSD = \frac{v_{85} t_r}{3,6} + \frac{v_{85}^2}{254 \left( \frac{a}{g} \pm \frac{G}{100} \right)} \quad (7)$$

Where:

SSD – stopping sight distance;

$v_i = v_{85}$  – initial or 85<sup>th</sup> percentile of speed;

$t_r$  – reaction time;

$f_l$  – longitudinal friction coefficient;

$a$  – deceleration rate,  $a = 3.4$  m/s<sup>2</sup>;

$G$  – grade percent (vertical slope in %).

### 3 Sight distance calculation – Case study in the City of Rijeka

Faculty of Civil Engineering Rijeka, Chair for Transportation engineering in cooperation with Department for municipal system, City of Rijeka conducted a case study of available sight distance at an urban intersection in the City of Rijeka. The aim of the study was to test different methodologies of sight distance calculation as well as to suggest improvements in given situation [8]. The chosen intersection was three – leg uncontrolled intersection with obligatory STOP sign, distinctive for greater amount of detected traffic accidents. The most common accident type detected at the site are improper left turn from minor road (8 of 11 recorded accidents were of this type), which can be connected with insufficient sight distance for drivers approaching intersection from the minor road as well as vehicle impact from the back (3 of 11 recorded accidents) connected with insufficient stopping sight distance.

#### 3.1 Site measurements

The measurements conducted on the studied intersection were speed measurements and friction coefficient measurements [8]. Actual vehicle speed was measured with traffic counters Datacollect SDR Traffic+ positioned in few characteristic points inside the intersection area with continuous traffic flow measurement during 3 workdays.

Friction on main road was measured with a fixed slip measurement device installed in a vehicle with travel speed of approximately 50 km/h, where the average measured friction coefficient for both traveling directions was  $f_L = 0,55$ . This data was used in stopping sight distance calculations according to PIARC's formulation (Eq 6.). Frictional characteristics on minor road were determined by SRT Pendulum device suitable for friction coefficient prediction at lower traveling speed. However, stopping sight distance for the minor road was calculated with PIARC's Equation 7, including deceleration rate  $a = 3,4 \text{ m/s}^2$  due to lack of information for transferring SRT value into coefficient of friction.

### 3.2 Comparison of sight distances calculated on the basis of different standards

The analysis of available sight distance was conducted by calculating sight distance values using Standard and comparing it with recommended values from the same Standard and Guidelines. Sight distance according to Standard was calculated with real speed measured on the intersection –  $v_{85}$  which was established to be approximately 10 km/h higher than presupposed design speed  $v_g$  (50 km/h).

Sight distance calculations were also made according to The Greenbook and PIARC's RSM in order to compare recommended and calculated values. Since The Greenbook also presupposes design speed, the calculation was made with the actual measured speed and compared with values calculated with design speed. Table 3. summarizes all conducted calculations of sight distance based on different calculation methods, according to conducted case study [8].

**Table 3** Sight distance (SD) calculation results and mutual comparison between different standards and recommendations

STANDARD/ GUIDELINE	SPEED (design $v_g$ /actual $v_{85}$ )	SIGHT DISTANCE (recommended/calculated)			
Croatian standard	$v_g = 50 \text{ km/h}$	$SD_{rec.} = 91 \text{ m}$			
HRN U.C4.050	$v_{85} = 60 \text{ km/h}$	$SD_{calc.} = 96 \text{ m}$			
Croatian Guidelines	$v_{85} = 60 \text{ km/h}$	$SD_{rec.} = 85 \text{ m}$			
AASHTO's	$v_g = 50 \text{ km/h}$	$SD_{rec.L} = 105 \text{ m}$	$SD_{rec.R} = 91 \text{ m}$	$SD_{rec.LM} = 77 \text{ m}$	
Greenbook	$v_{85} = 60 \text{ km/h}$	$SD_{calc.L} = 126 \text{ m}$	$SD_{calc.R} = 109 \text{ m}$	$SD_{calc.LM} = 92 \text{ m}$	
PIARC's RSM	$v_{85} = 60 \text{ km/h}$	$SD_{calc.L} = 135 \text{ m}$	$SD_{calc.R} = 115 \text{ m}$	$SD_{calc.LM} = 99 \text{ m}$	

Calculation results given in Table 3. show that required values for calculated sight distance vary by as much as 50 meters. Also, there is a quite difference detected between calculated sight distance needed for different manoeuvring types, and neither Standard nor Guidelines, usually used in Croatia, give distinctive difference between manoeuvring types. Another significant difference can be detected by comparing sight distance values calculated according to design speed  $v_g$  and measured speed  $v_{85}$  when comparing foreign standards that include different time intervals for different manoeuvring types. The difference between calculated values is by as much as 15-20%, where the calculated sight distance value regarding the measured vehicle speed is approximately 20 m longer than the sight distance calculated with the design speed. Finally, after detecting real sight distance values needed according to measured speed, sight triangles were created to visualize given values and determine whether available sight distance ensures safe traffic conditions on analysed intersection. Figure 2. presents sight triangle created using calculated sight distance for the same vehicle speed according to the Standard (upper scheme) for left turn from minor road and the sight triangle for the same manoeuvre according to PIARC's RSM recommendations (lower scheme). From both sight triangle visualisations it is obvious that there is a lack of visibility for the vehicles turning left according to eastern intersection approach, and also from the western approach considering PIARC's sight distance values.



**Figure 2** Sight triangle visualisations for left turn from minor road considering calculated sight distance using Croatian standard (upper scheme) and PIARC's RSM (lower scheme)

Since the calculated values of sight distance mostly depend on vehicle speed approaching the intersection, the conclusion in this case was that mandatory speed reduction would definitely contribute to necessary sight distance decrease and improvement of traffic safety conditions on this intersection.

The same type of comparison was used for stopping sight distance values calculation according to different standards and recommendations, observing stopping sight distance from STOP line on minor road and possible conflict points inside intersection area between vehicles on major and minor road [8]. Stopping sight distance for pedestrian crossings on both major and minor road was also reviewed and calculated using the same equations and parameters as for the previous calculations. Table 4. summarizes stopping sight distance values calculated with recommended and measured speeds according to standards and recommendations mentioned in previous chapter.

**Table 4** Stopping sight distance (SSD) calculation results and mutual comparison between different standards and recommendations

STANDARD/ RECOMMENDATION	MAJOR ROAD		MINOR ROAD	
Croatian Guidelines	$v_{85(rec.)}^* = 50$ km/h	SSD = 40 m	$V_{85} = 40$ km/h	SSD = 25 m
	$v_{85(real)} = 60$ km/h	SSD = 60 m		
AASHTO's Greenbook	$v_{g(rec.)} = 50$ km/h	SSD = 64 m	$v_g = v_{85} = 40$ km/h	SSD = 46 m
	$v_{85(real)} = 60$ km/h	SSD = 83 m		
PIARC's RSM	$v_{85(real)} = 60$ km/h	SSD = 51 m	$v_{85(real)} = 40$ km/h	SSD = 42 m



**Figure 3** Sight triangle visualisations for pedestrian crossings on major and minor road considering calculated stopping sight distance using Croatian guidelines (left scheme) and AASHTO's Greenbook (right scheme)



Figure 3. shows sight triangles for actual stopping sight distance needed for major and minor road to ensure safe traffic conditions for pedestrians on intersection, according to Guidelines (left scheme) and The Greenbook (right scheme). The sight triangle visualisations show general deficiency of visibility for pedestrians crossing minor road, but also insufficient visibility for pedestrians crossing major road according to US recommendations.

In this case can also be noticed difference among calculated values of sight distances for vehicles and pedestrians. In all cases Croatian methods allow solutions in which lower safe distances (both manoeuvring and stopping sight distances) are acceptable.

## 4 Conclusion

Analyses of parameters included in calculation of manoeuvring sight distance and stopping sight distance in different methods (Croatian, USA, PIARC) and their application in real intersection conditions confirmed limitations of Croatian standards in the case of calculation of sight distance. Comparison of the calculated distances in the case of three leg non-signalized intersection showed that distances calculated on the basis of Standard were significantly lower than those calculated on the basis of Greenbook or RSM. Among three methodologies PIARC's RSM happened to be the most conservative in calculated distances, by suggesting longer necessary distances than other methods and it has to do with the fact that they take into consideration measured ( $v_{85}$ ) and not design speed ( $v_d$ ). The other problem with Croatian Standard is that they don't respect the fact of different time intervals needed for different manoeuvring directions at the intersection.

These are the reasons why Croatian regulations prescribe lower levels of sight distances which can potentially result in lower level of traffic safety so their revision can be recommended.

## Acknowledgements

This paper is a result of case study supported by University of Rijeka through project "Sustainable design of pavement structures in urban areas" in cooperation with City of Rijeka, Department for municipal system. The equipment used in this case study is funded by European Union through RISK project.

## References

- [1] PIARC Road Safety Manual, PIARC Technical Committee on Road Safety, 2003.
- [2] FREE SPEED SURVEY 2011(Urban and Rural), Research department, Road Safety Authority, Dublin-Ireland, March 2012, [http://www.rsa.ie/Documents/Road%20Safety/Speed/Speed\\_survey\\_2011.pdf](http://www.rsa.ie/Documents/Road%20Safety/Speed/Speed_survey_2011.pdf), March 1<sup>st</sup>, 2016.
- [3] Bilten o sigurnosti cestovnog prometa 2012., RH MUP, 2013., [http://www.mup.hr/UserDocImages/statistika/2013/bilten\\_2012.pdf](http://www.mup.hr/UserDocImages/statistika/2013/bilten_2012.pdf), March 2<sup>nd</sup> 2016.
- [4] HRN U.C4.050 Površinski čvorovi, 1990.
- [5] Cvitanić, D., Vujasinović, A., Stazić, T.: Preglednost cestovnih raskrižja; Građevinar 63 (2011), pp. 859-868
- [6] Smjernice za projektiranje raskrižja u naseljima sa stajališta sigurnosti prometa FPZ i PGZ/HC, 2004.
- [7] A Policy on Geometric Design of Highways and Streets, fourth edition, AASHTO, 2001.
- [8] Case study: "Pilot projekt unaprjeđenja stanja sigurnosti u zonama gradskih raskrižja i pješačkih prijelaza izvan raskrižja poboljšanjem hvatljivosti kolničkih površina", Department of Transportation, Faculty of Civil Engineering Rijeka, November 2015.



## INCREASING ROAD SAFETY BY IMPROVING ILLUMINATION OF ROAD INFRASTRUCTURE

Flavius-Florin Pavăl

*Romanian National Company of Motorways and National Roads (R.N.C.M.N.R.), Romania*

### Abstract

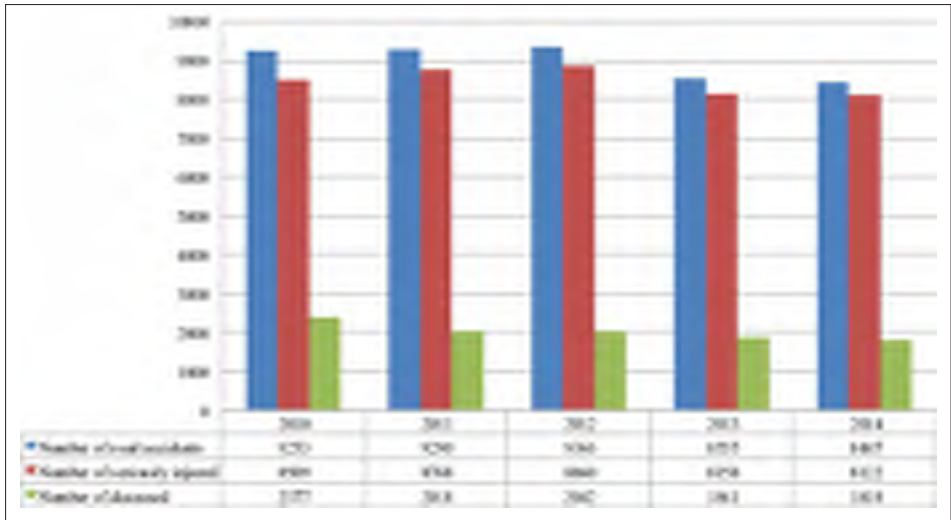
As all Member States of the EU also Romania is a country that has made objective of reducing by 50% the number of deceased victims from road accidents, by 2020. To achieve the stated objective, it is necessary to implement rapid on the entire road network, technical solution to improve road infrastructure and increasing the visibility of drivers. In order to increase road safety by reducing the number of traffic accidents is required luminance increasing existing roads due to the key role of ensuring greater visibility. In the case of road infrastructure is used luminance, which is the amount of light fell on a surface and reflection. In this article we will present different solutions of increasing luminance on different road sections by changing minor technical solutions such as: a) choosing of different types of materials to build roundabouts and b) changing the size of geometric elements of road infrastructure.

In this article will be presented the best technical solutions to choosing lighting road infrastructure, after carrying out a survey results and a modeling software program in a specific lighting. One of the measures to increase road safety awareness implemented lately is making roundabouts in order to decrease the number of conflict points at intersection. Roundabouts are good technical solutions for increased road safety provided but only for drivers wich respect the speed limits imposed. Given the inappropriate behavior shown by traffic participants regarding compliance requirements and roundabouts are a modification of road infrastructure alignment, their illumination is required.

### 1 Introduction

The European Union has imposed on all Member States an extremely important objective in terms of increasing traffic safety by reducing by 50% the number of deceased victims of road accidents by 2020. Compared to the EU, our country is unfortunately a leading position in the number of people killed in road accidents, but lately have been implemented road safety measures which led to the existence of a descendent trend but insufficient compared with the European average. On the network of national roads and motorways in the period 2010-2014, the number of people seriously injured or died as a result of road accidents decreased significantly, especially in the year 2014.

In Romania as in other European countries, to achieve its stated objective, it has started implementation of several modern technical solutions in order to increase traffic safety and one of the most used solution that has proved effective in decreasing the number of accidents is the roundabout. Another measure of increasing road safety on the roads, which it is envisaged to be implemented both in Romania and abroad, is the realization of lighting, especially sectors that present a high risk for drivers.



**Figure 1** Number of road accidents produced in the period 2010-2014 on national roads and highways in Romania

## 2 The Roundabout

Roundabouts are intersections with a single carriageway traveled in one way around a central island. Vehicles undergoing ring driven over the roundabout have priority over those entering the roundabout. The solution adoption of roundabouts, traffic intersections for treatment, is viewed with much interest in many countries nowadays, especially for reasons of traffic safety and ensure proper quality fluent. The main advantages of roundabouts are:

- **Traffic safety:** the risk of accidents is (very) low. The first reason is the low travel speeds, both convergent traffic intersection and the one who runs the roundabout itself. A second reason is the number of potential conflicts between road users, which is lower than other types of intersections.
- **Quality traffic flows:** Roundabouts provide higher levels of service for all participants, compared to intersections regulated by traffic signs or the traffic lights.



**Figure 2** Example of roundabout with two lanes per direction

The technical solution roundabout is a potentially beneficial for road safety and ensure a higher quality of traffic flows but providing lighting Their heady necessary because, otherwise, this solution is presented as an obstacle to drivers due to changes drastically alignment of road infrastructure.

### 3 Visibility of road networks

Given the fact that roundabouts drivers sense prevail and therefore those wishing to enter it must slow down or stop, drivers should benefit from increased visibility that currently measures ensure lighting. Depending on the technical solution required, roundabouts can have central island of a small height that will ensure observation vehicles are also those who enter into them on the opposite side, or have central island with a significant size that will ensure only observing the vehicle which is in turn. In cases where there is a history of non-compliance with speed limits of drivers, roundabouts practiced with center island with great height so as to lead to an order reducing speed.

### 4 Case Study – Lighting roundabouts

This article will present the influence of chromatic material used to build a roundabout on simultaneously with its illumination of road safety. In the field of lighting for the road sector, the most important aspect is the luminance because it is the coefficient of light that is reflected more accurately characterize the brightness of objects.

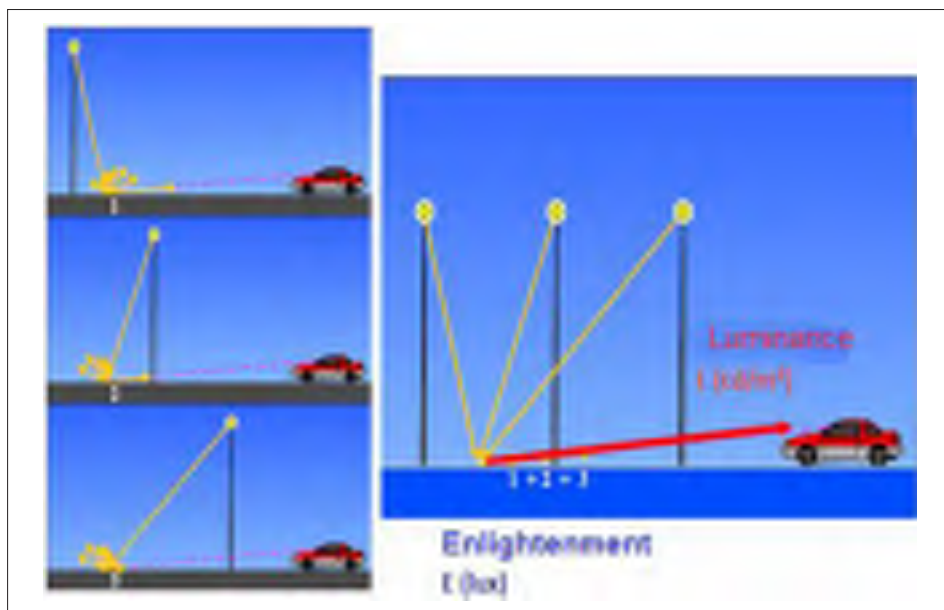


Figure 3 The principle of enlightenment and luminance

Luminance is the measure used in the design and verification of lighting and road infrastructure networks is measured in  $\text{cd}/\text{m}^2$ . By achieving an optimal luminance it is envisaged the drop of blinding drivers, both disability glare (reduced visibility is physiological and represent) and the blindness of discomfort (psychological and unpleasant conditions that create visibility). For the tests in this article, was chosen the technical solution roundabout with center island with significant height or 2 meters and a solution of road illumination lighting apparatus.



Figure 4 The technical solution – roundabout



Figure 5 The technical solution – roundabout

Simulation illumination was performed using the software DIALux, where he was selected the next unit of LED lighting and the layout was optimized by the program in compliance with condition (imposed) to ensure a degree of uniform illumination of at least  $1.5 \text{ cd/m}^2$ . (Since this simulation we assumed that talk of a roundabout with traffic we considered important and significant need to ensure lighting has been chosen ME2 lighting class according to SR EN 13201- lighting road traffic routes). Lighting appliance has the following important features: Luminous flux (luminaire): 18,500 lm; Beam (lamps): 14,800 lm; Luminaire power: 138 W.

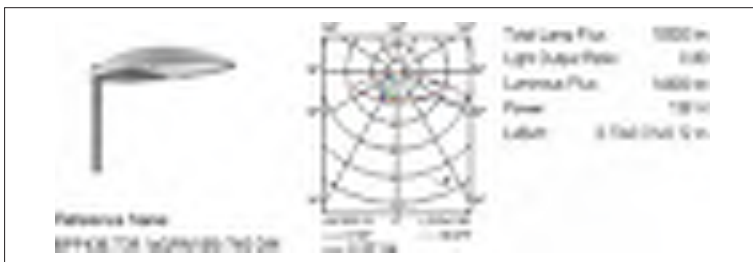


Figure 6 The Lighting appliance

After the calculations and optimizations performed by the program, the chosen solution was an arrangement of luminaires at a distance of 34 m and a height of 10 m with a degree of ori-

entation of the device 0°. Simulations were conducted in March, the only element changed was the material used to cover the roundabout, namely:

- Case I – was supposed to cover the central island was used paving brick-colored tiles:

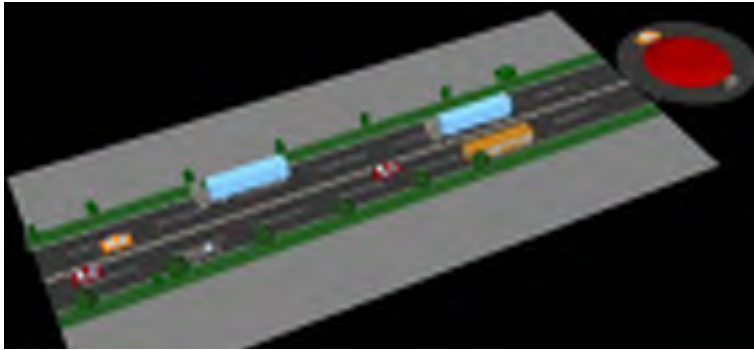


Figure 7 The central island of roundbout covered with brick-colored tiles

- Case II – was supposed to cover the central island was used pavement tiles in gray:

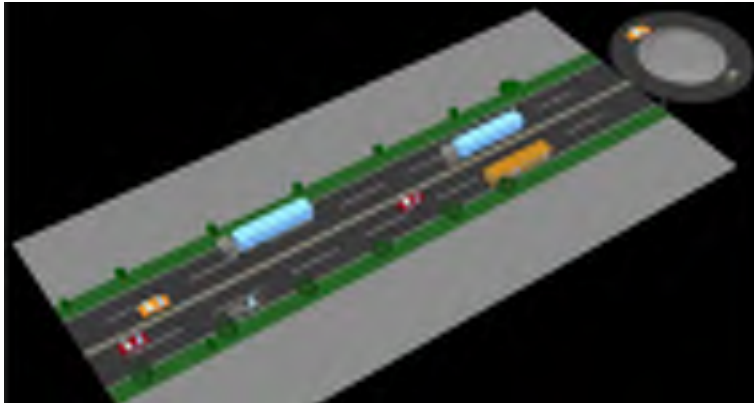


Figure 8 The central island of roundbout covered with gray pavement tiles

- Case III – it is also contemplated that cover the central island of grass was used:



Figure 9 The central island of roundbout covered with grass.

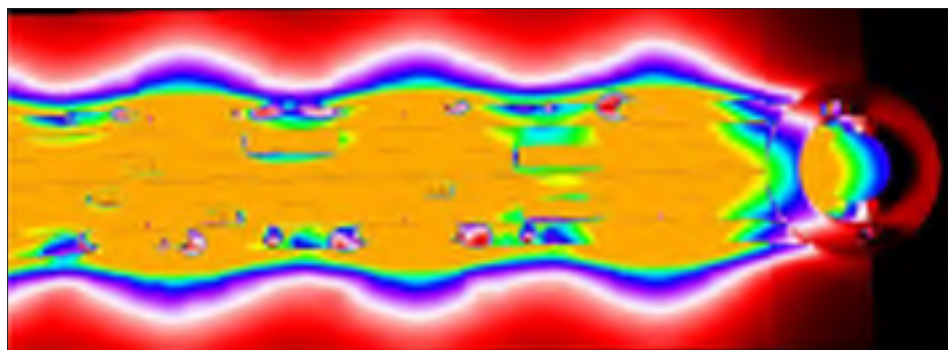


Figure 10 Luminance curve

Table 1 Measuring results.

Material used to cover center island	Luminance		
	the centreline, at the upper limit of island	the centreline, at the middle of island	left side at the border of visibility
brick-colored tiles	1.33	1.39	1.31
gray pavement tiles	1.51	1.55	1.48
grass	1.39	1.45	1.39

## 5 Conclusions

The best visibility for drivers due to a higher degree of illumination is provided by the solution roundabout with center island with paving slabs of concrete gray detrimental use of grass or pavement slabs of concrete brick red. Following the simulation carried out in the case study presented revealed that it can get a higher degree of light just by changing chromatic materials used without changing luminaire types and their positioning.

## Refereces

- [1] Flavius-Florin, P.: “Influența cromaticii sensurilor giratorii asupra gradului de siguranță rutieră” – Conferința științifică internațională “Cercetare și administrare rutieră/ Bucuresti, 09 – 11.07.2015 – COD ISSN 2457–5259;
- [2] Flavius-Florin, P.: “Influența cromaticii sensurilor giratorii asupra gradului de siguranță rutieră” – Revista drumuri si poduri NR. 148 (217)/ octombrie 2015 – COD ISSN 1222-4235;
- [3] Andrei, C., Flavius-Florin, P.: “Soluții moderne de amenajare a punctelor negre în vederea scăderii numărului de accidente rutiere”, Congresul national de drumuri si poduri din Romania – 10-13.09.2014;
- [4] CP D.02.10:2014 – Cod practic în construcții, Construcții hidrotehnice: Rutiere și speciale, Ministerul Dezvoltării regionale și Construcțiilor, Republica Moldova – 2014;
- [5] “Intersecții giratorii – Aplicații și proiectare – Un manual practic”, Ministerul Transporturilor, Lucrărilor Publice și Gospodărirea Apelor – “Parteneri pentru Drumuri” – 2009;
- [6] Manual de siguranța rutieră, Administrația de Stat a Drumurilor, Republica Moldova – 2011;
- [7] Maierean, M.: “Suprafețe”, Suport Curs “Specialist în iluminat”, București, CNRI – 13-26.05.2015;





## TRAFFIC SAFETY ASSESSMENT MODEL METHOD – SSAM

Gregor Kralj, Marko Jelenc

*PNZ svetovanje projektiranje d.o.o., Slovenija*

### Abstract

Paper lists some modern models used to assess traffic safety, paying special attention to an increasingly widespread traffic safety assessment tool based on the model method, i.e. SSAM (Surrogate Safety Assessment Model). The traffic safety analysis of a road or road network segment using this model method is based on a microscopic traffic model whose precision ensures high-quality SSAM analysis. The SSAM software analyzes individual vehicle trajectories exported from the microscopic model and outputs the various interactions between individual vehicles as well as a list of all potential traffic accidents. The paper will show all the possible analyzes and results of such a traffic safety analysis. A concrete example, a connection road between the north and south bypass roads in Bled together with both roundabouts will also illustrate the theoretical part of the paper. For this example, a microscopic model has been with software tool PTV Vision, Vissim 5.40. This microscopic model was used as a basis for the SSAM traffic safety analysis. The results of analysis will be presented at the end of the paper. The results were used to improve the solution used by the main project.

### 1 Introduction

Generally, traffic safety is nowadays one of the most important and one of the most frequently mentioned aspect in modern designing of infrastructure. If we imagine the world and road transport some decades back, this was not the case. To all of traffic safety methods is common that they are about to improve accident rates on roads. Among various methods for traffic safety assessment that are listed in this paper, software tool SSAM (Surrogate Safety Assessment Model) is presented into details. SSAM method is increasingly in use in preliminary studies where different variants of solution are designed. The analysis made by software tool SSAM is then used for deciding, which variant is the best solution to be built.

### 2 Traffic safety models

In order to reduce the road accident rates that are results of inadequate designing, planning and less safe design solutions, various traffic safety models are developing globally. Generally, we can divide them in two groups of traffic safety models – Accident Prediction Models (APM) and Traffic Safety Assessment Models (TSAM) [1].

#### 2.1 Accident Prediction Models

Accident Prediction Models are mathematical formulation of traffic safety indicators according to variables, which affects on indicators. Indicators are:

- number of accidents,
- number of injuries and
- number of deaths.



Variables are:

- road length,
- road width and
- traffic load – Average Annual Daily Traffic (AADT).

Parameters of equation includes also vehicle characteristics, environment and psychophysical elements of drivers. Accident Prediction Models are mainly used for global predictions of traffic accidents, but they are based on statistical information about collision history.

## 2.2 Traffic Safety Assessment Models

Traffic Safety Assessment Models are different methodologies and software tools based on various theoretical basis. Their main use is for making decisions between different project solutions in order to select the optimal variant. Choosing the project solution on blind and waiting for statistics on actual traffic accidents is for society unacceptable, so the TSAM are right decision, how to respond to the above written thesis. There are many TSAM programs available on the market and there are quite few still developing. Some of them are listed below [4]:

- ANFIS (Adaptive Neuro Fuzzy Inference System),
- model MARViN (Model for Assessing Risks of Road Infrastructure),
- CRF (Crash Reduction Factors),
- IHSDM (Interactive Highway Safety Design Model),
- HSM (Highway Safety Manual) and
- SSAM (Surrogate Safety Assessment Model).

## 3 Surrogate Safety Assessment Model (SSAM)

### 3.1 General

SSAM was developed in “Turner-Fairbank Highway Research Center” (McLean, Virginia, US) in association with FHWA (US Federal Highway Administration) and Siemens Energy & Automation (Tucson, Arizona, US). This tool determine the frequency and type of conflict points. As already mentioned, SSAM major advantage is that it allows traffic safety analysis of the planned road infrastructure before building it. It is also very useful when making comparative analysis [3].



Figure 1 Microscopic simulation made by PTV Vision: VISSIM

### 3.2 Working procedure [2]

For the best possible results with SSAM in detail microscopic model of study area should be developed (figure 1 shows a part of microscopic simulation mad by PTV Vision: VISSIM software tool). Microscopic model should be prepared with a program that allows us to export trajectories files of each and every single vehicle in microscopic simulation. We can choose between different programs for microscopic models. Here are some of them (PTV Vision: VISSIM, Paramics, AIMSUN or TEXAS).

The figure below shows a scheme in which SSAM works. So we need, as already mentioned, good microscopic model, from which we export trajectory files of several analysis (with minimum, middle, high and maximum traffic load and with at least three different random seeds). All this data is then analyzed with SSAM software tool.

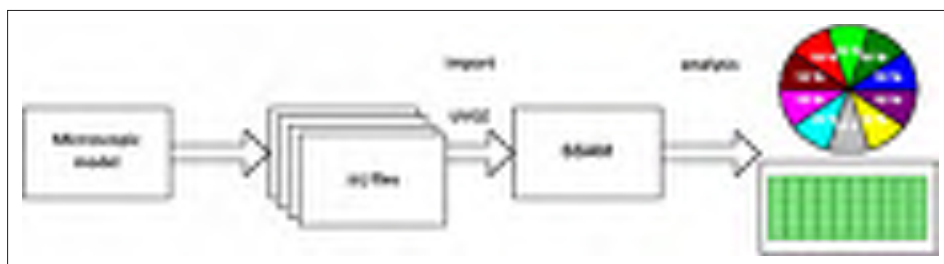


Figure 2 Scheme of work flow using SSAM

### 3.3 Results [2]

As a result of SSAM analysis we get a table of all conflicts with number of different type of conflicts and all other traffic-safety parameters values. These traffic-safety parameters are:

- TTC (time to collision),
- PET (post-encroachment time),
- MaxS (maximum speed),
- DeltaS (maximum speed differential),
- DR (initial deceleration rate),
- MaxD (maximum deceleration rate) and
- MaxDeltaV (vehicle velocity change)

Interpretation of SSAM results is very complex. All the traffic-safety parameters are heavily interconnected, correlated and complementary to each other, so none of the traffic-safety parameters by itself is not sufficient to make final conclusions and findings. For proper interpretation of the results, person with relevant experience and certain knowledge is needed.

### 3.4 Visualization of conflicts

SSAM allows some static visualization of results. You can export pictures with marked points, which represent conflicts. Usually conflicts are filtered according to parameter TTC (time to collision). SSAM allows also some additional filters that can be applied to each of the parameter and type of conflicts, which are divided according to angle of possible collision.

Figure 3 on next page represents already mentioned type of conflict according to angle between trajectories of involved vehicles.

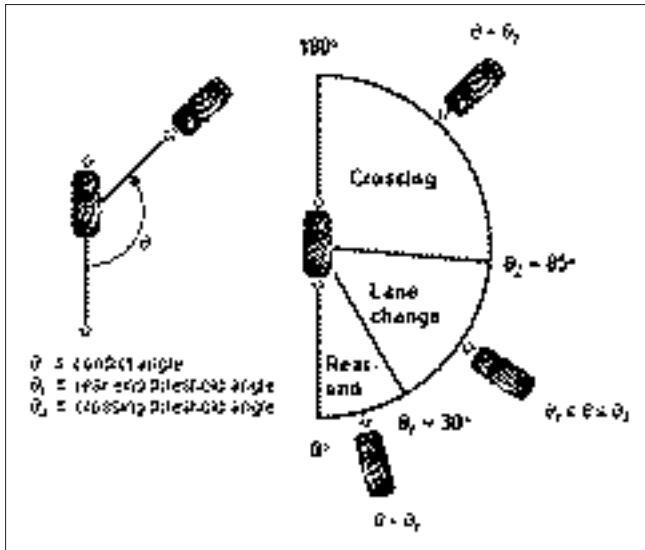


Figure 3 Conflict types by angle [2]

Figure 4 below represents example of static visualization as exported picture made by SSAM. Conflict icons are colour coded according to their time-to-collision values.



Figure 4 Visualization of conflicts

## 4 Practical example

The area of study was connection road (Ljubljanska cesta) between south and north bypass road in Bled, Slovenia. The study with SSAM was made as a comparison between three different variants of solution. The variants were:

- Variant 1: Full connection of both Gregorčičeva streets and one-sided two-way bicycle path,
- Variant 2: Full connection of both Gregorčičeva streets and two-sided one-way bicycle path,
- Variant 3: Divided connection of both Gregorčičeva streets (only with right-right maneuver possible) and one-sided two-way bicycle path.

SSAM first result is the table of conflicts. As I already mentioned, several analysis by PTV Vision: VISSIM 5.40 software tool were made with minimum, middle, high and maximum traffic load. Table 1 below represents such table of conflicts.

**Table 1** Number of conflicts for variants

% of peak hour load	40			60			80			100			Σ		
Variant	V1	V2	V3	V1	V2	V3	V1	V2	V3	V1	V2	V3	V1	V2	V3
Seasonal peak hour (2015)	2	4	3	7	14	6	14	11	17	60	49	58	73	78	84

As you can see, in seasonal peak hour load of year 2035, variant 1 have lowest number of conflicts. About display of the location of conflict on the network map, with icons of different shapes and colors assignable to different conflict types or severities has already been presented in previous chapter and on figure 4.

**Table 2** Values of other traffic-safety parameters for variants

% of peak hour load	40			60			80			100			Σ		
Variant	V1	V2	V3	V1	V2	V3	V1	V2	V3	V1	V2	V3	V1	V2	V3
TTC	0,70	0,50	0,67	0,38	0,33	0,35	0,37	0,17	0,27	0,34	0,14	0,22	0,35	0,16	0,28
PET	1,17	0,50	0,89	0,83	0,45	0,71	0,90	0,27	0,32	0,65	0,17	0,32	0,64	0,21	0,49
MaxS	15,01	11,80	12,52	10,84	10,46	11,68	10,10	11,89	12,08	9,74	9,15	10,04	10,06	9,91	10,66
DeltaS	21,67	12,41	13,62	11,88	9,32	10,40	8,57	10,93	7,96	7,87	7,92	8,97	8,76	8,82	9,03
DR	-0,03	-1,77	-3,27	-0,90	-1,99	-3,10	-1,56	-2,70	-3,15	-1,39	-2,30	-0,65	-1,34	-2,27	-1,42
MaxD	-3,56	-2,77	-3,85	-3,42	-2,60	-3,92	-4,08	-4,61	-4,38	-1,80	-3,05	-1,61	-2,44	-3,17	-2,41
MaxDeltaV	11,37	9,58	8,19	6,68	5,86	6,16	5,31	6,33	5,23	5,50	5,30	5,63	5,74	5,77	5,68

In table 2, another more complex results of SSAM analysis is shown, which represents seven other traffic-safety parameters that have been mentioned in chapter 3.3.

### 4.1 Decision according to SSAM results

As the area of study is not so large, the interpretation of SSAM results is not that complex in shown example. As already mentioned, Variant 1 has the smallest number of conflicts and also all other traffic-safety parameters speak in favor of Variant 1 or are in the same range of values as by two other variants. Also other traffic measures speak in favor of Variant 1. The duration of delays for studied area is smallest, therefore Level of Service (LOS) is better than by other two variants. Variant 1 also have shortest columns and according to microscopic simulation Variant 1 has better transmittance than other two variants.

## 5 Conclusion

SSAM provides a compelling new option to assess the safety of traffic facilities using popular microsimulation software. This approach circumvents the need to wait for “abnormally high” crashes to actually occur, allows assessments of hypothetical designs and control alternatives, and is applicable to facilities where traditional, volume-based crash-prediction models (and norms) have not been established. Research is ongoing in this area, and as simulation models and video technology improve, this technique is expected to grow in use.

## References

- [1] Guzelj, T., Jelenc, M.: Prometne nesreče na državnem omrežju in metode za ocenjevanje prometne varnosti. Portorož, DRC, 2008.
- [2] Surrogate Safety Assessment Model (SSAM), <http://www.fhwa.dot.gov/publications/research/safety/08049/>, 05.04.2016
- [3] Douglas, G., et al.: Surrogate Safety Assessment Model and Validation, final report, Tucson, AZ, US and McLean, VA, US, Federal Highway Administration: Turner Fairbank Highway Research Center, 2008.
- [4] Rijavec, R., et al.: Alternativne metode zaznavanja prometnega toka v območju križišč, Ljubljana, Direkcija Republike Slovenije za ceste, 2010.

## 15 COMPUTER TECHNIQUES AND SIMULATIONS





## SELECTED ASPECTS OF NUMERICAL AND EXPERIMENTAL STUDIES OF PROTOTYPE RAILWAY WAGON FOR INTERMODAL TRANSPORT

Wieslaw Krason, Tadeusz Niezgodą, Michal Stankiewicz  
*Military University of Technology, Poland*

### Abstract

A special wagon with a low rotatable loading platform for transportation of truck vehicles by rail was developed in Military University of Technology in Poland. The essence of such reloading is to place a semitrailer on a special rotatable platform with the use of a truck tractor. The structure can be used for transportation of different types of vehicles. The wagon allows quick and fast loading and unloading without any platform infrastructure or terminals. This type of railway wagon will allow transport companies to save time and money spending on road transport. The advantages of this construction are reduction of a negative impact on the environment as well as an increase of road safety by reducing the number of vehicles on the roads. As part of the work on the wagon and the intermodal transport system, a strength test of the wagon structure was carried out and the effort of the basic components of the wagon and a complete structure was estimated. In order to test the correctness of constructional assumptions and initially verify the wagon project, the dynamic analyses of the construction in different stages of its development were also carried out with the use of a multibody method and ADAMS code. Based on the performed strength tests of the wagon, it was verified that the most strenuous component of the wagon with a rotatable loading platform is a lock coupling the side of the rotatable platform with the over bogie part of the frame wagon. The construction of the applied lock allows only the transmission of axial load in respect to the side of the wagon. To analyse a side lock element, FE analysis was performed. The selected aspects of numerical and experimental studies of the prototype railway wagon and its components are presented in the paper.

*Keywords: special railway wagon for intermodal transport, the subassemblies separated from the wagon structure, numerical analysis, experimental stand tests of the side lock*

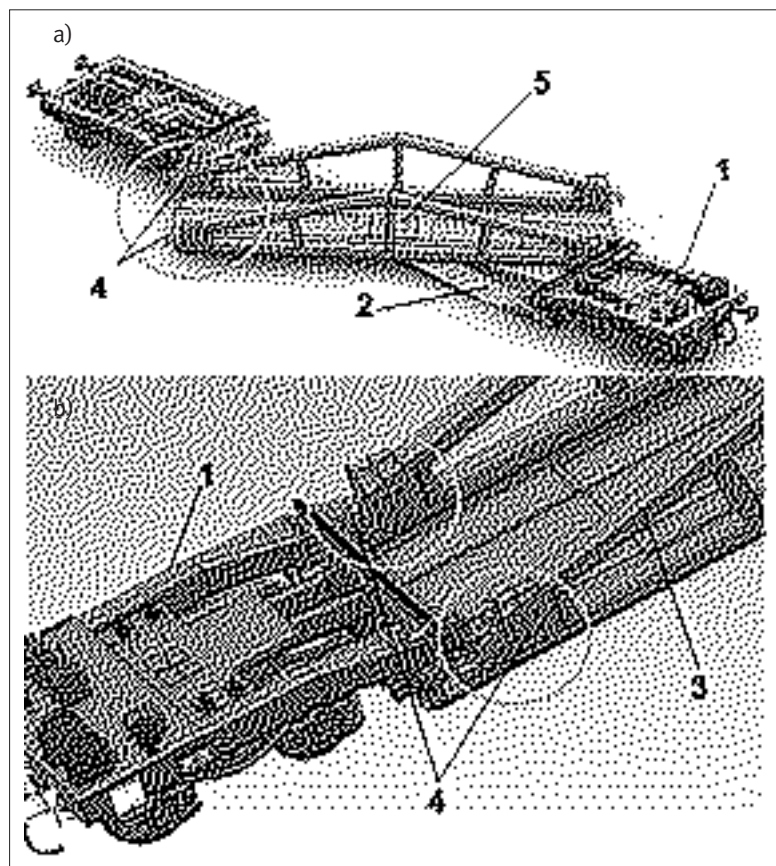
### 1 Prototype railway wagon for intermodal transport

A intermodal wagon [1, 2] with a low rotatable loading floor (Fig.1) for transportation of truck vehicles by rail is the subject of our consideration. This structure consist of the light and lowered bottom of the frame, the rotatable floor of the body for a transported load and the standard railway bogies [3, 4]. The wagon allows quick and fast loading and unloading without any platform infrastructure or terminals. The following constructional assumptions are made in the project of the special wagon for intermodal transport:

- mass of the semitrailer with load up to 40 tons, wagon weight up to 45 tons,
- meeting the requirements of GB 1 railway gauge,
- low placed rotatable loading floor for autonomous loading-unloading allowing individual loading-unloading of the wagon,



- application of standard biaxial bogies of Y25 type with allowed pressure on the axis 22.5 tons,
- the structure can be used for transportation of different type of vehicles such as tractors, trucks, trailers, semitrailers and cargo containers.



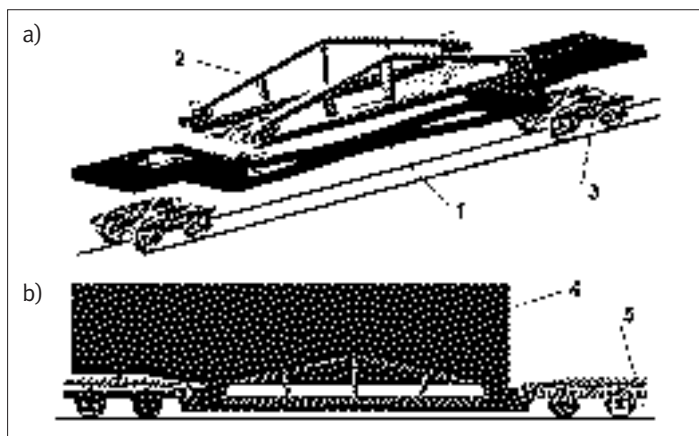
**Figure 1** Prototype version of the wagon with :a) the open loading platform, b) the closed loading platform with the view of lock components: 1 – over-bogie part of the wagon , 2 – the lowered fixed frame of wagon , 3 – the side of the moving loading platform, 4 – hook shape locks with support area , 5 – central node of the rotatable platform

The paper presents selected aspects of research on the prototype railway wagon [3, 4] and separated subassembly of the locks, connecting a rotatable platform with an immovable over bogie part of the wagon for intermodal transport. Numerical model and analysis of the complete wagon and the most effort part are applied. Different shapes of the lock components are prepared for the experimental tests. The results of the stand investigation are used to verify the numerical model and methodology applied for computer simulations. Selected strength assessments based on the analysis of numerical and experimental results are included in the paper.

## 2 Numerical investigations of the complete wagon

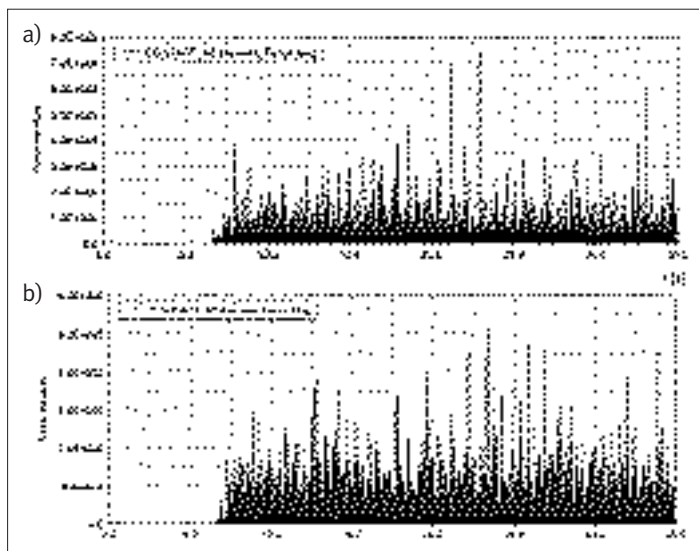
Different variants of complete railway wagon models are developed for numerical analysis. Simulation of the tests of the wagons in motion with mapping of the appropriate conditions of the track formation was carried out using multibody analyses and MSC Adams software [5].

A model of the railway wagon for a multibody simulation (Fig. 2a) is built of rigid solids based on the design documentation and PN-EN standards [6, 7]. The main components of the wagon and contact connections between them are taken into account.



**Figure 2** A View of 3D numerical model: a) multibody model with main subsystems; 1 – chassis frame of the wagon, 2 – rotatable platform, 3 – Y25 type bogie with suspension, b) FE model of the complete wagon for dynamic simulation [8]: 4 – semitrailer with load , 5 – railway track

Forces of reaction and forces in contact connectors (Fig. 3) of the most strenuous parts of the wagon are estimated as a result of multibody analyses. The loads values determined in this manner are used in experimental tests of wagon components, including a side lock (the subassembly operating between the rotatable platform and the wagon frame). Selected FE numerical simulations corresponding to the experimental tests of this wagon subassembly are presented in the further parts of the paper.



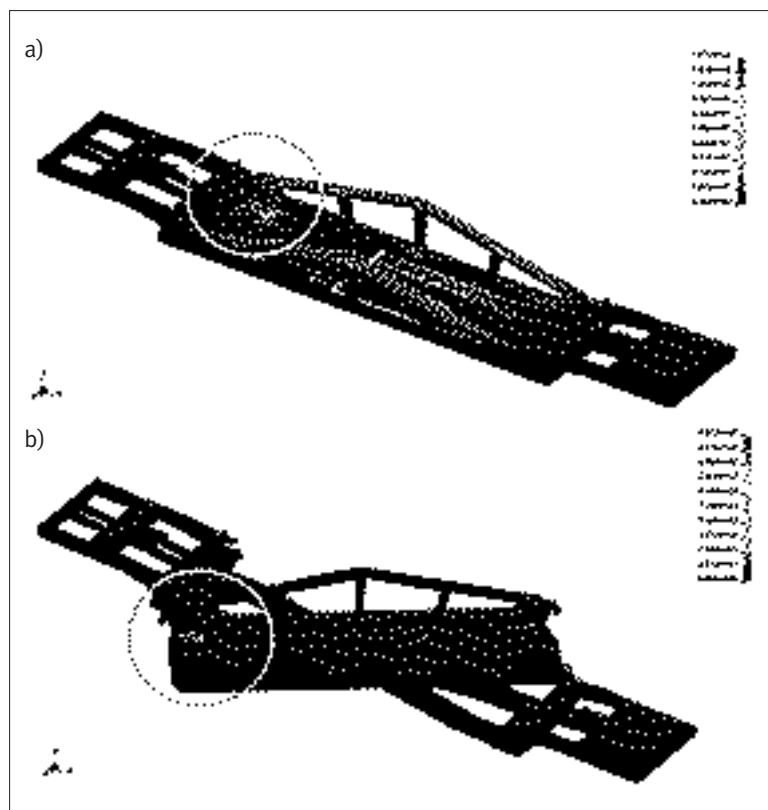
**Figure 3** The chart of contact forces in the selected track lock as the result of 3D multibody analysis: a) during passage of the wagon on the curved track at a speed of 60km/h, b) during passage of the wagon on the curved track at a speed of 80km/h

Numerical FE analyses of a complete wagon are carried out as well [8 ÷10]. The deformation strain and stresses (Fig. 4) of particular elements of such a construction in different configurations are determined. Boundary and initial conditions corresponding to strength tests of cargo wagons and specified in the standard EU-PN were taken into consideration [6, 7]. The most strenuous and vulnerable to damages area of the railway wagon structure is identified based on the FE numerical results. For this purpose, a numerical 3D model (Fig. 2b) of the complete wagon is used.

### 3 Stand tests and the object of investigations

The locks coupling the side of the rotatable platform with the over bogie part of the frame of the special wagon (Fig. 1) are identified as the most strenuous component of the wagon with a rotatable loading floor [8 ÷10]. Therefore, stand tests and numerical analysis of the separated components of the side lock are performed.

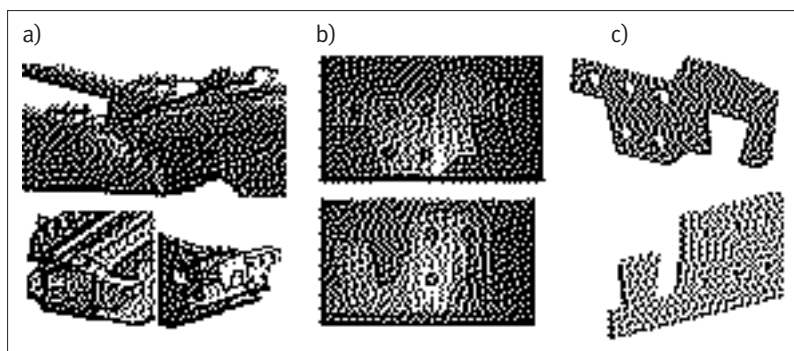
The parts of the lock, in the close configuration (Fig. 1b), are loaded mainly with longitudinal tensile and compressive forces. The design of the applied lock allows only transmission of axial load in respect to the side of the wagon. The purpose of the joint is also to relieve the central node, which is used mainly for positioning and rotation loading platform of the wagon. Rotations of the wagon platform to the load-unload position (Fig. 1a, 4b) are possible after unblocking the locks (4).



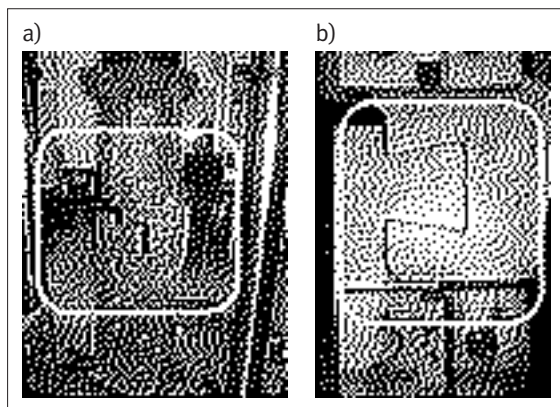
**Figure 4** FE numerical result – HMH stress of the lock components areas in the special wagon with the  $1.95 \cdot Q$  load and: a) closed platform after unblocking the side locks –  $\sigma_{\max} = 157$  MPa, b) opened platform with load and rotated by an angle of  $50^\circ$  –  $\sigma_{\max} = 357$  MPa

One of the solids of such locks areas is the over bogie part (1) connected with the lowered fixed frame (2) of the wagon – Fig. 1. The other part of the lock area is the side of the moving loading platform (3) connected with the use of nine screws. Components of the lock (4) constitute a connection between the raceway on the over bogie frame in the rotation process of the floor in respect to the central node (5). The side locks (4), according to preliminary design assumptions, should relieve the area of the central node positioning the rotatable platform over the lowered part of the wagon frame. The central node (5) is used mainly for rotation of the loading platform in respect to the wagon frame and the platform ramp.

The stand tests of the separated components of the side lock with the use of the experimental equipment of Strength of Materials Laboratory at Military University of Technology were performed. Components of the side lock (Fig. 5, 6), with real dimensions of the connector (1:1 scale) are used during the strength tests. Owing to a large size and considerable mass of the lock subassemblies, it has been decided that the elements used for the experimental research will be plates of a real solids shapes (Fig. 5, 6), which are the clippings with thickness of 30 mm. It corresponds to 1/10 of the width of the actual lock (300 mm). Two different shapes of the connector are used in stand tests. The hook shape connector (Fig. 5a, 5b) was used at initial version of the side lock. Separated components of the side lock in the form of the dovetail joint (Fig. 5c) are tested in the next stage. Static compression and tensile tests of a separated lock connectors with two different shape are performed on a hydraulically driven machine INSTRON SATEC within a range of forces up to 1200 kN (Fig. 6).



**Figure 5** Views: a) side lock area between rotatable platform and over bogie part of the intermodal wagon, b) separated hook-shaped connector prepared to tests, c) 3D draw of dovetail joint



**Figure 6** Photos of the tested components of the side lock and the test stand view with INSTRON SATEC machine: a) hook-shaped connector, b) separated component in the form of the dovetail joint

Strength force – displacement curves, presented in Fig. 7, are recorded during the stand test of two type of the side lock connectors.

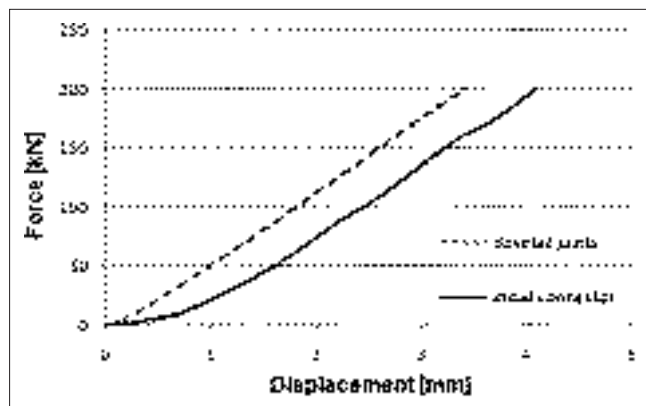


Figure 7 Force – displacement curves recorded during the stand test for two types of the side lock connectors

#### 4 Results of the experimental and numerical study

This part of the paper presents the selected aspects of numerical research on the separated subassembly of a lock. Separated components of the side lock mapping two different shapes of connector (as in the experimental tests described in chapter 3 of the paper – Fig. 5 and 6) are used in numerical FE models as well. The selected results from experimental tests of the side lock components are used to verify a numerical model and FE methodology used for simulations. FE various models (Fig. 8) and numerical analysis of the most effort part of the lock are applied. Numerical analyses of lock tensile within a nonlinear range are performed using MSC software [10]. Load was defined as the reduced force linearly increasing to the value of  $P_{max}=200$  kN. Comparison of the results is shown in Table 1. Displacements recorded during the experimental test and the ones determined using FE models and numerical analysis in both variants of the lock connectors are discussed. Figure 9 shows a map of displacements of lock plates determined numerically in FE models. The result for the initial shape of the hook-lock connector are presented in Fig. 9a. The displacement map for a modified dovetail joint is shown in Fig. 9b.

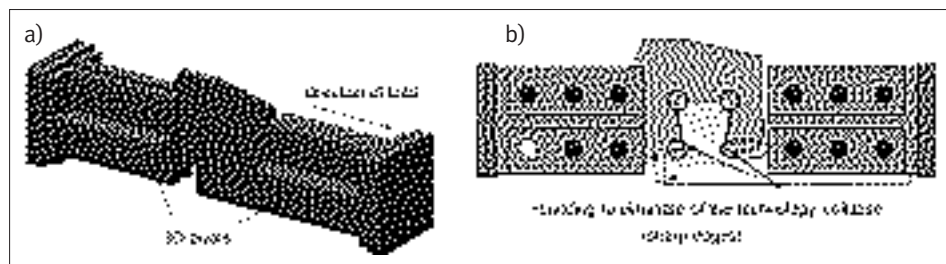


Figure 8 FE models mapping two different shapes of the lock connectors (as in the experimental tests): a) initial hook-shape lock, b) modified dovetail joint without sharp edges

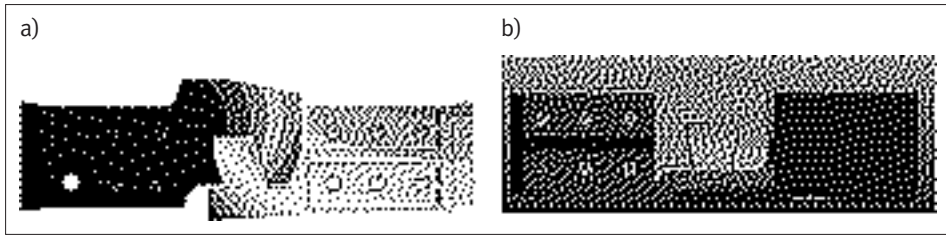


Figure 9 Displacement maps for: a) initial shape of the hook-lock connector, b) modified dovetail joint

Table 1 Comparison of the FE and measuring results

Load – P force = 200 kN	Displacements [mm]	
	Initial connector	Dovetail joint
FE models	4.8	3.8
Experiment	4.4	3.3

## 5 Conclusions

Based on a comparison of displacements from the numerical analysis and the ones experimentally measured, it was verified that both of the discrete models of the tested set with a non-linear material model and load boundary conditions properly and sufficiently reflect the actual construction of the side locks system and the applied holders. It was found that deformability of the modified dovetail joint is less than in the case of the initial hook-shape lock. Maximal longitudinal displacements of two type connectors differ up to 25%. Numerical models and computer simulations, presented in the paper, can be used for further strength tests of the wagon side locks with the use of more complex load states and mapping of dangerous, from the point of view of their exploitation, conditions.

## References

- [1] Kwasniewski, S., Nowakowski, T., Zajęc, M.: Transport intermodalny w sieciach logistycznych. Oficyna Wydawnicza Politechniki Wrocławskiej, 2008.
- [2] Mindur, L., others: Combined Intermodal Transport, Technologies of Transport, Publisher ITE-PIB, Warszawa-Radom, 2014.
- [3] Military University of Technology: A railway wagon and a mechanism for rotating and blocking a loading floor of a railway wagon for combined transportation, EU Patent EP 2 532 562 A1, 2012.
- [4] Military University of Technology: A railway wagon with a rotatable loading floor”, EU Patent, EP10461528, 2013.
- [5] MSC.ADAMS, Release Guide, Published by MSC, 2005.
- [6] PN-EN 12663: Railway applications, Structural requirements of railway vehicle bodies, Warsaw, 2002.
- [7] PN-EN: 13232-1, Railway applications, PN-EN Standards, Warsaw, 2004.
- [8] Krason, W., Niezgoda, T.: FE numerical tests of railway wagon for intermodal transport according to PN-EU standards , Bulletin of the Polish Academy of Sciences, Technical Sciences, Vol. 62, No. 4 , October 2014, p. 843 – 851, 2014.
- [9] Military University of Technology, The innovative technology of railway transport of TIR type trucks, National Center of Research and Development, Report of MUT, Warsaw, 2012.
- [10] MSC.Patran/Nastran/Marc, Reference Manuals, MSC.Software, 2005.







## DEVELOPMENT OF SPECIALIZED FORCE SENSOR FOR RAILWAY WAYSIDE MONITORING SYSTEMS

Nencho Nenov<sup>1</sup>, Emil Dimitrov<sup>2</sup>, Petio Piskulev<sup>1</sup>, Nikolay Dodev<sup>1</sup>

<sup>1</sup> *University of Transport, Department of Transport equipment, Sofia, Bulgaria*

<sup>2</sup> *Technical University of Sofia, Department of Electronic technology, Bulgaria*

### Abstract

The paper is dedicated to the development of a specialized tensometric force sensor which will be implemented in railway wayside monitoring systems. The developed sensor will be a basis to implement number of facilities for control on wheel load of railway vehicles in motion. The global goal is the improvement of the main engineering and economic indicators: reducing wear of wheel and track; reducing failures and damages in the wheeled part of rail vehicles, increasing the inter-repair runs; improving the comfort of riding, etc.

The innovation aspect in the paper is optimization in the sensor structure by mathematical modelling and numerical examination on its behavior by varying geometric parameters and under different model of loading. The optimization of the sensor structure is achieved by: creating of a 3D model of the sensor; determining deformation and stress states of the sensor under load; optimizing the sensor geometric dimensions in order to increase its sensitivity; extending the measuring range of the sensor and accuracy of measurement. Simulation of the sensor model is performed with characteristics modes of loading. Also a new technology for management and control on the process of polymerization of strain-gauge rosettes is developed. The technology includes low temperature curing process with precise computer control system, developed specially for this purpose. The results obtained from the advanced sensor have confirmed the possibility to measure the loads of railway vehicles in motion at an operating speed. The force sensor has been tested under laboratory conditions and is fir for implementation in practice.

*Keywords: force measurement, railways, modelling, numerical analysis, monitoring systems*

### 1 Introduction

Taking into account the present-day operating conditions of the railway transport we are able to distinguish two major trends in the roadside inspection and monitoring of trains and railway infrastructure.

The first trend is associated with the continuous increase in the volume of freight and passengers, while increasing vehicle speeds, i.e. there is a constant increase in the intensity of transport activity.

The second trend is associated with reducing (and in some railway administrations to even complete removal) of the staff employed for roadside control and observation of trains and railway infrastructure. The trend is due to the fact that this activity has low performance and low efficiency. Many of the damages to the rolling stock cannot be detected and promptly addressed in such a way.

Combining the two trends and at the same time preserving the level of safety and operating reliability of the railway transport is impossible without using modern automated systems



for wayside monitoring. These systems have to be able to detect most of the defects in the passing trains, which could lead to severe accidents, and in the same time to generate an alarm in order quick addressing of the issues.

In order to detect wheel defects in the passing trains such as flat spots, out of roundness, polygonization, etc. and to measure the current load distribution between the wheels and the vehicle weight, the research team has developed a specialized force sensor, which will be implemented in a wayside monitoring system for the needs of the railway in Bulgaria.

## 2 Measuring principle and modelling of the force sensor

### 2.1 Measuring principle

The measuring principle is based on measuring of the deformation of a beam on two supports. The beam represents a 1140 mm long P49E1 rail section. The deformation is measured in two sensitive areas of the rail web. The areas are at the same distance from the middle of the rail section. In order to increase the deformation in these areas, the web of the rail is milled on both sides. The linear deformation in these areas is measured by XK11K-3/350 strain-gauge rosettes – Fig. 1. The force applied by the wheel on the rail is determined by the deformation measured in the two sensitive areas. The strain-gauge rosettes are connected in a full bridge connection – Fig. 2.

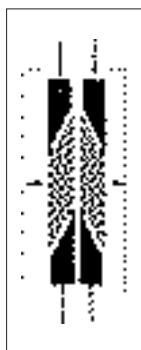


Figure 1 XK11K-3/350 strain-gauge rosette

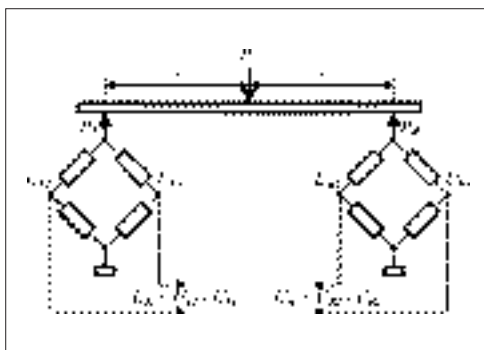


Figure 2 Full bridge connection of strain gauge rosettes

Depending on the location of the force, there are two cases of stress state of the sensor. The first case is pure lateral bending – when the resultant force acts in a vertical plane of symmetry, passing through the longitudinal axis of the rail section. The second case is lateral oblique bending – when the force is in common position on the head of the rail section. The trajectory of the principal stress is a line which tangent in every single point coincides with the direction of one of the principal stresses in this point. It gives clear idea of the stress flow in the loaded body. In each point of the rail section exist two perpendicular directions of the principal stresses. Fig. 3 shows two families of curves, representing the trajectories of the principal stresses.

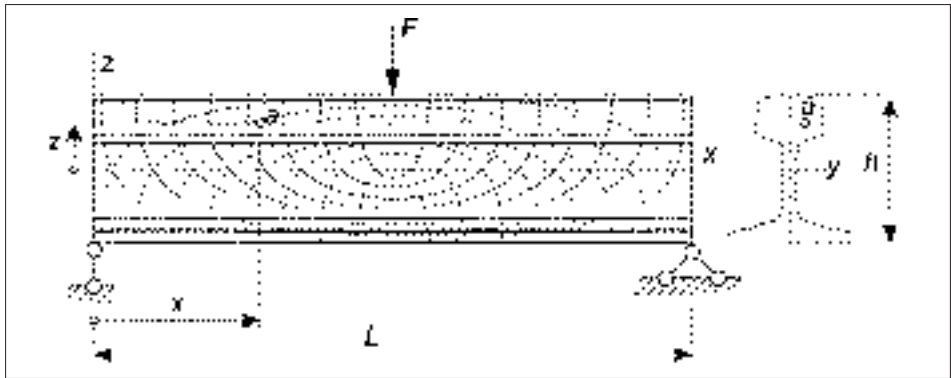


Figure 3 Trajectories of principal stresses in the sensitive rail section

From the foregoing it is clear that making only one sensitive area on the rail section is not very appropriate decision. This is due to the fact that while moving the force and positioning it over the sensitive area it will not be possible to correctly register it. The use of two sensitive areas would eliminate this inconvenience and at the same time will limit the length of the linear portion of the rail section (located between the two sensitive areas) in which it will be possible to achieve accurate measurement of the force.

The two sensitive areas (left and right) are located at 130 mm from each end of the rail section which overall length is 1140 mm. After milling the web of the rail its thickness at the sensitive areas has become 6 mm. For each of the sensitive areas two strain-gauge rosettes are used. Each rosette is installed on one side of the sensitive area – left and right. The rosettes for each sensitive area are connected as a full bridge. Fig. 4 clearly shows the rail section with its sensitive areas and the connection of the strain-gauge rosettes.

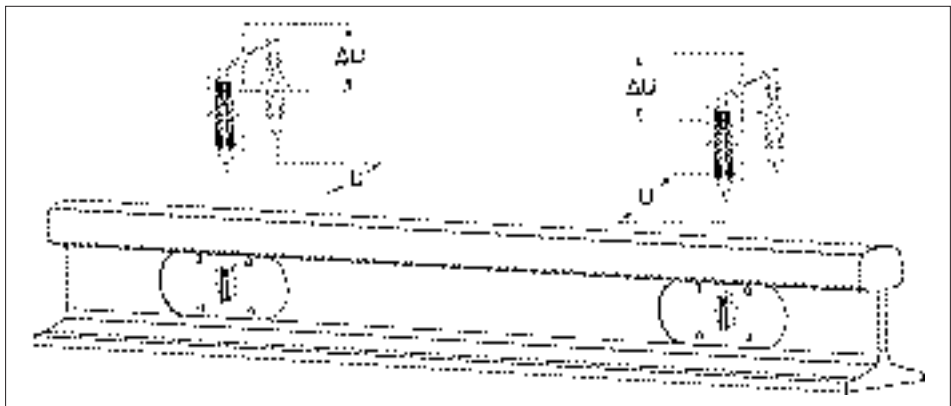


Figure 4 Installation and connection of the strain-gauge rosettes at the sensitive areas of the rail section

## 2.2 Modelling of the force sensor of rail type

In order to examine the behaviour and optimize the performance of the force sensor the research team has developed a 3D model which was subjected to finite element analysis. The modelling of the force sensor includes several stages.

The first stage is 3D modelling of each solid part, needed for construction of an assembly. The assembly comprises of three solid parts – Fig. 5 – the rail section with its sensitive areas, a loading element for applying force to the rail section, and a ribbed pad of rail type P49E1. To create the 3D models, SIEMENS NX 9.0 software is used [1], [2].

The second stage is assembling the 3D models. The goal is to achieve equivalence between the model and the loading conditions of the force sensor.

The third stage is approximation of the 3D models with finite element meshes. This stage is crucial for achieving accurate results of the finite element analysis [3]. Each of the 3D models of the assembly is approximated by a single 3D mesh of finite elements. The creation of the meshes includes: selection of mesh type – 3D tetrahedral; selection of finite element type – CTETRA (4) and CTETRA (10); specifying of finite elements size – 3 mm; selection of physical properties; specifying the links between the individual meshes of finite elements – Glue Coincident and Free Coincident. In this stage a selection of Solver (software for calculation of the strength-strain state) is also made – SIEMENS NX Nastran 9.0 [4].



Figure 5 3D models of the force sensor assembly

The final – fourth – stage includes specifying the loading and boundary conditions and specifying how the load is transmitted between the individual meshes, i.e. 3D models, during the analysis – Surface to Surface Contact and Surface to Surface Gluing. Fig. 6 shows the model of the sensor ready for analysis.



Figure 6 3D model of the force sensor ready for analysis with defined finite element meshes, loading and boundary conditions, and mating conditions

### 3 Examination of the force sensor

As mentioned above, two sensitive areas are created in the rail section body by milling the rail web. In these areas the strain-gauge rosettes are installed.

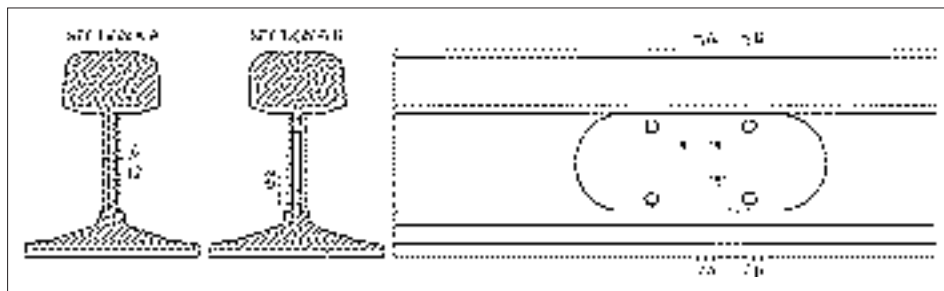


Figure 7 View of a sensitive area with technological holes and cross section of rail, showing the thickness of the web

The selection of the thickness of the rail web in the sensitive areas is a major step of the construction of the force sensor of rail type. The thinner rail web leads to higher values of the principal stresses at the areas where the strain-gauge rosettes are installed and also to higher coefficient of sensitivity. There are two reasons with negative influence in the desire for making the rail web thinner in the sensitive areas. The first is related to the possibility the sensitive areas to loose stability and to begin to behave as a “fictitious holes” in the material. The second is related to the influence of the technological holes in the sensitive areas. They act as stress raisers, which distorts the principal stresses field in the immediate vicinity to the holes. By using the 3D model described above, several numerical experiments were conducted in order to determine the influence of the web thickness in the sensitive areas. The experiments were conducted for web thickness from 3.0 to 8.0 mm in increments of 0.5 mm. Fig. 8 shows the identified relation of the shear stresses to the thickness of the rail web in the sensitive areas.

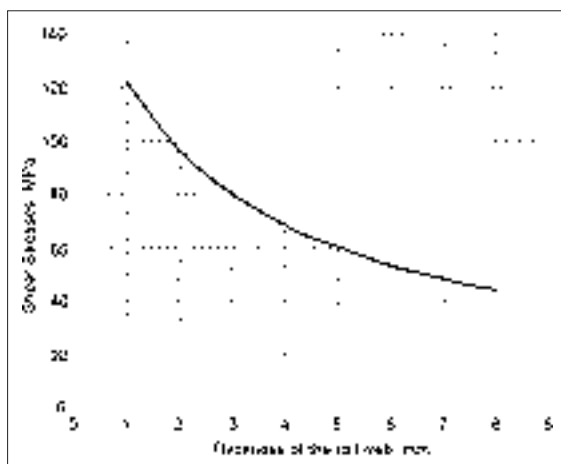


Figure 8 Relation of the shear stresses to the thickness of the rail web in sensitive areas

The shear stress values at small thickness of the rail web are under the critical stress value for rail type P49E1, but for thicknesses under 4.0 mm a stress concentration in the vicinity of the holes is observed, which could lead to metal fatigue, cracking and as a result – damage

to the sensor. While the rail web thickness is between 4.0 and 8.0 mm, the stress concentration around the holes does not influence the stress state in the zones where the strain-gauge rosettes are installed.

#### 4 Technology of polymerization of the strain-gauge rosettes

The process of polymerization of the strain-gauge rosettes is carried out in a low temperature chamber with a maximal temperature of 170°C. As the force sensor of rail type is positioned vertically in the chamber, the installation zones of the rosettes are conventionally marked as lower and upper. Forced ventilation ensuring internal circulation of heated air is used. As shown in Fig. 9, after initial heating to about 80°C (taking 1 hour) heaters are switched off, which allows to keep the temperature in the range 60°C ÷ 80°C for about 2 hours and 45 minutes. Then heaters are switched on again for about 3.5 hours, followed by switching off for 45 minutes and switching on for about 45 minutes last. Polymerization of strain gauge rosettes is obtained at temperatures above 130°C for not less than 5 hours.

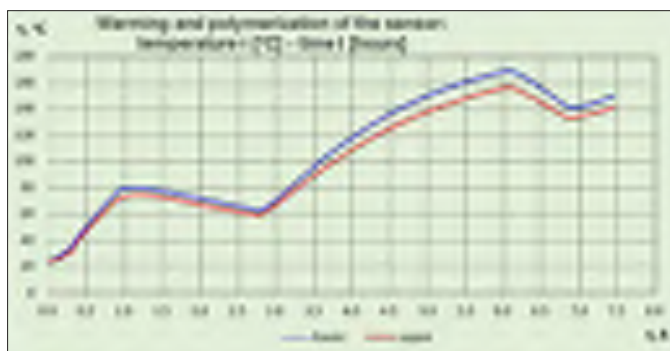


Figure 9 Diagram of polymerization of strain-gauge rosettes

#### 5 Results

Results from the finite element analysis of the force sensor of rail type are shown on Fig. 10. As it is shown, the point of applying the force is slightly moved to the right of the center of the sensor of rail type. It is clear how the stress values of the left and the right sensitive areas differs and the closer the force is to the corresponding area, the higher the stresses are there.

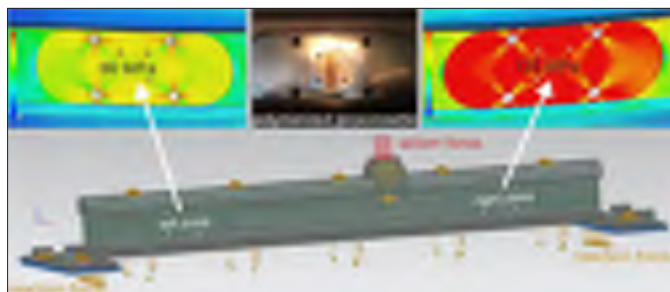


Figure 10 Stress states of left and right sensitive areas with asymmetric force application

A study on the sensor carried out by changing the point of applying force measured along the length of the sensor within  $\pm 350$  mm from the center has been performed. The signal

measured in the left and right sensitive areas and totally for the sensor as well as deviation of measured values from mathematical expectation in the sensor sensitivity are shown in Fig. 11. It was found that within  $\pm 200\text{mm}$  from the sensor center the deviation of the measured values from mathematical expectation (err) varies from  $-0.2\%$  to  $+0.4\%$ . Therefore the accuracy of measurement in the so-defined area of sensor sensitivity is ensured. Fig. 12 shows the newly-developed advanced force sensor of rail type.

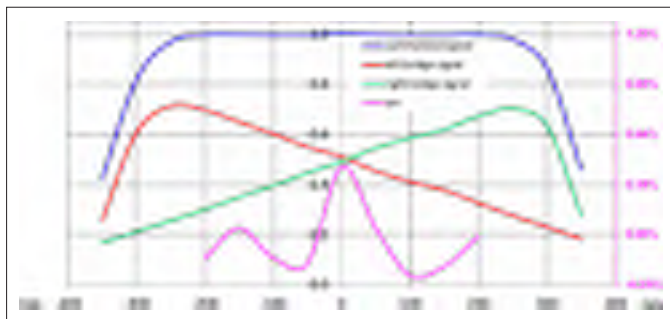


Figure 11 Diagram of polymerization of strain gauge rosettes



Figure 12 General appearance of the force sensor of rail type

## 6 Conclusion

It should be noted that the objectives of this study have been fully achieved. An advanced specialized force sensor of rail type intended to measure the vertical load on wheels of rail vehicle in motion at operating speed is designed. The sensor metal structure is optimized and strength-strain state is examined with varying geometric parameters and different modes of loading. New technology for management and control on the process of polymerization of strain-gauge rosettes is developed. The force sensor has been tested under laboratory conditions and is fit for implementation in wayside monitoring systems in practice.

## References

- [1] Leu, M., Thomas, A., Kolan, K.: NX 9.0 for Engineering Design, Missouri University of Science & Technology, <http://web.mst.edu/~mleu/>.
- [2] Binde, F.: NX9.0 Manual, Binde Training, [www.nx-manual.com](http://www.nx-manual.com).
- [3] NX Advanced Simulation User's Guide.
- [4] NX Nastran User's Guide, 2011.





## UNDERSTANDING AND PREDICTING GLOBAL BUCKLING DURING CONSTRUCTION OF STEEL BRIDGES

Steve Rhodes, Philip Icke, Paul Lyons

LUSAS, UK

### Abstract

Collapse of steel bridges during construction can occur as a result of a global buckling behaviour which may be overlooked when using member resistance checks such as those in the Eurocodes. Furthermore, buckling can require careful study when working with existing structures that were not constructed to modern tolerances and which consequently cannot be safely assessed using modern design codes. It is an issue of design, construction and sustainability. This paper describes how finite element analysis can be used to predict buckling modes. It draws on recommendations in the recently published NCHRP Report 725 [1], exploring the problem of global buckling modes and considering how to identify when these should be of concern to the designer. Use of FE analysis in the determination of member resistances is also discussed, with reference to current design standards and to alternative approaches which may be appropriate for historical structures, drawing out the key considerations and necessary checks when undertaking such analyses.

*Keywords: steel bridges, buckling, construction, finite element analysis*

### 1 Introduction

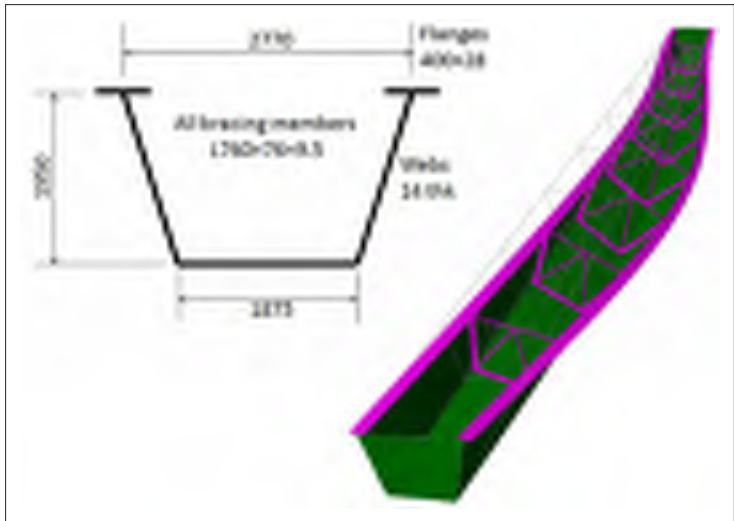
Buckling analyses performed using Finite Elements (FE) may be elastic or nonlinear. Elastic buckling analyses give results which may be used in member resistance calculations in codes of practice, and – crucially – can be used to identify ‘global’ buckling modes not routinely identified when carrying out such checks (see Figure 1 below). Nonlinear buckling analyses may also be useful in certain cases, such as when considering existing structures which have details and tolerances that fall outside modern standards. This paper explores the practical applications for both of these buckling analysis options.

### 2 Elastic buckling analyses using FE

In FE analyses, the real or potentially real object is idealised as a series of ‘elements’, connected at nodes. For analysis of bridge structures in 3D, the most commonly used elements are beam elements – suitable when a member is long in comparison to its cross-sectional dimensions; and shell elements – suitable when a member has plan dimensions which are large in comparison to its thickness. FE models may use mixed elements and can be used to analyse members or whole structures, considering non-standard details, support conditions and load arrangements as necessary.

In the FE solution, a stiffness matrix is constructed, based upon the member dimensions, material properties and support conditions. When combined with the loading, a linear static analysis can be performed. Alternatively, an elastic buckling analysis can be carried out, determining the eigenvalues of the stress-stiffness matrix and the corresponding eigenvectors.





**Figure 1** Global buckling mode causing collapse of Marcy pedestrian bridge

The eigenvalues obtained from an elastic buckling analysis each give the factor,  $\alpha_{cr}$ , by which the applied loading would have to be increased to cause elastic instability in the corresponding mode (determined from the relevant eigenvector).

Due to material plasticity, initial imperfections (including out-of straightness and residual stresses) and second-order effects (large displacement theory), the experimental buckling resistance of a member is generally less than might be inferred from an eigenvalue ‘load factor’, although post-buckling behaviour allows certain classes of member to achieve a higher resistance (see Galambos [2]).

Nonetheless, elastic buckling – and therefore eigenvalues – are of immense use to practicing engineers, as described in the following sections.

### 3 Global buckling phenomenon

The Marcy pedestrian bridge in Figure 1 collapsed during construction in New York State, 2002, when the concrete deck pour was about 60% complete (Yura & Widiyanto, [3]). It was a straight, single span trapezoidal box of 52m, with a design complying with the appropriate member resistance clauses in the US standards of the time. The Marcy collapse was caused by a ‘global’ buckling mode which may equally arise in other girder systems. Member resistance checks considering buckling between bracing locations may indicate adequacy, but the braced system can buckle in a lower mode over an effective span-length.

#### 3.1 Identifying susceptible structures

A ‘global’ mode such as the one which caused the Marcy collapse can be identified with an elastic buckling analysis and the corresponding load factor,  $\alpha_{cr}$ , allows an assessment of whether the mode could occur under the design loads.

For the reasons already described,  $\alpha_{cr}$  cannot be thought of as a factor of safety against buckling. Instead it is more helpful to use it in the calculation of an ‘amplification factor’,  $AF_G$ :

$$AF_G = \frac{1}{1 - \frac{1}{\alpha_{cr}}} \quad (1)$$

Expression 1 above is based on NCHRP Report 725 [1] (Eqn 2) and conceptually might be used to factor up responses obtained from a linear static analysis in lieu of a second-order (geometrically nonlinear) analysis. Hence, the report indicates, where  $AF_G < 1.1$ , the influence of second-order effects may be neglected whereas where  $AF_G > 1.25$  then the adequacy of the structure must be justified and a comprehensive nonlinear analysis is recommended.

Calculation of  $AF_G$  is recommended because the value gives engineers a sense of the inaccuracy associated with the results obtained from their linear static analysis. In fact EN1993-1-1 [4] clause 5.2.1(3) also deems second-order effects negligible when  $\alpha_{cr} \geq 10$  (corresponding to  $AF_G > 1.1$ ), but experience suggests that engineers find it difficult to regard a factor of 10 as entirely necessary.

In either case, a global buckling mode and corresponding value for  $\alpha_{cr}$  needs to be determined. Yura et al [5] propose some simplified expressions which can be used for this purpose, based upon a pair of identical, prismatic, doubly-symmetric I-section girders with effective bracing, subject to a uniform moment. They offer adjustments for singly symmetric sections, consideration of up to 4 girders and moment gradients but even so, the limitations are such that for most practical cases, an eigenvalue buckling analysis using FE can be used to give a greater level of accuracy and confidence.

### 3.2 Example – Marcy Pedestrian bridge

For the purposes of this paper, the Marcy Pedestrian bridge was retrospectively modelled using LUSAS (Figure 1). The webs, bottom flange and diaphragms were represented using quadratic order thick shell elements (QTS8), while the compression flanges and bracing were represented using quadratic order thick isoparametric beam elements (BMI31) ref. LUSAS [6]. Such a model is capable of identifying a variety of buckling modes including local modes – and the critical global mode – and is rapid both in generation and solution, therefore an efficient model for this instance. Values for  $AF_G$  in Table 1 indicate significant second-order effects under merely the self-weight of the girder, considerably increased when the deck pour reached 60% completion – to the extent that the collapse would have been readily predicted by engineers using such data.

**Table 1** Key results from LUSAS analysis of Marcy pedestrian bridge

	Units	Self-weight of girder only	Added load of wet concrete
Eigenvalue load factor, $\alpha_{cr}$	none	3.32	1.07
Amplification factor, $AF_G$	none	1.43	15.28
Peak elastic stress in compression flange from linear static analysis, $\sigma_{x,Ed}$	MPa	50.7	136.9
Elastic critical stress, $\sigma_{cr} = \alpha_{cr} \times \sigma_{x,Ed}$	MPa	168.5	146.5
Amplified stress, $\sigma_{AF} = A_{FG} \times \sigma_{x,Ed}$	MPa	72.5	2091.8
Real world outcome		No collapse	Collapse

## 4 Member resistance calculations

The design resistances in the Eurocode, in common with other international codes, are based upon slenderness which is in principal defined from the critical elastic buckling load or moment – see  $N_{cr}$  in EN1993-1-1 [4] clauses 6.3.1.2(1) and 6.3.1.4(2) and  $M_{cr}$  in clause 6.3.2.2(1) respectively.

Values for  $N_{cr}$  and  $M_{cr}$  may be determined by any suitable means. Where members are of prismatic cross-section and within the standard section shapes, end restraints and loading conditions and moment distribution, the values are typically determined using closed form

expressions such as those available in SN001a [7] and SN003b [8]. For sections which fall outside such criteria, for example tapering sections – or indeed for any section –  $N_{cr}$  and  $M_{cr}$  may be determined using an eigenvalue extraction from an FE analysis, i.e.

$$N_{cr} = \alpha_{cr} N_{Ed} \text{ or } M_{cr} = \alpha_{cr} M_{Ed} \text{ as appropriate} \quad (2)$$

Importantly, buckling modes identified using FE may be visualised, potentially resulting in a better understanding of structural behaviour than when formulae are used ‘blindly’.

These critical elastic values ( $N_{cr}$  and  $M_{cr}$ ) are not themselves used as design resistance values because they do not take into account material plasticity, initial imperfections or second-order effects. The expressions for member resistance in the Eurocode make the necessary allowances leading to a safe design.

The ability to use eigenvalue analysis to determine slenderness for member resistance calculations makes it possible to use the codified expressions to determine resistances for quite non-standard structures, such as existing structures.

#### 4.1 Example – existing U-frame bridge

The assessment of existing railway structures in the UK is to NR-GN-CIV-025 [9], which requires member resistances to be calculated using BS5400-3 [10]. The bending resistance of the main girders in the U-frame bridge of Figure 2 below was assessed using the manual method of clause 9.6.4.1.3, and found to be inadequate for the Client requirements.

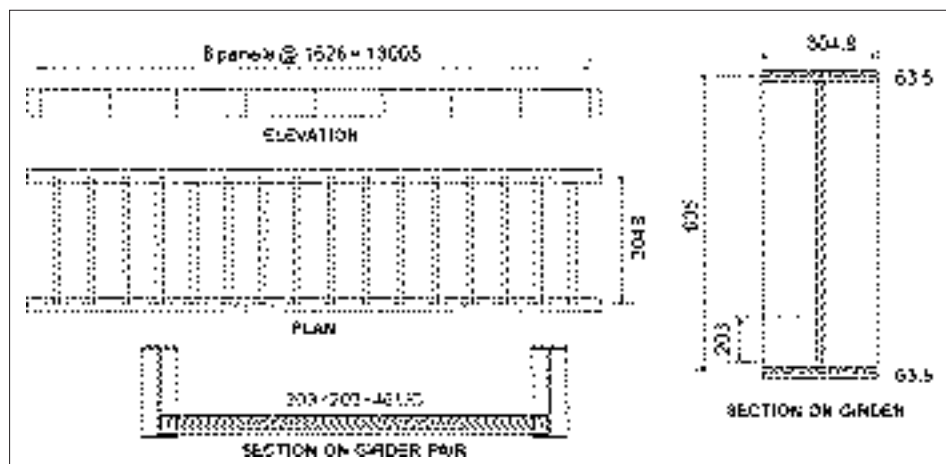


Figure 2 Example U-frame bridge deck

The member resistance for the main girders was then re-calculated, using an eigenvalue analysis of an FE model as illustrated in Figure 3. Using the load factor obtained to derive a slenderness in accordance with BS5400-3 [10] clause 9.7.5 (similar to the Eurocode approach); the calculated resistance was improved by 41% over the manual method of clause 9.6.4.1.3. In the FE model of Figure 3, shell elements are used to represent the main girders (webs, flanges and stiffeners) and the cross-members (webs and flanges). Using shell elements throughout ensures that buckling modes, global and local, are identified and can indeed contribute, together, to the predicted failure of the member in a full nonlinear analysis, if this is later required. Thus the small additional overhead in modelling and solution time associated with using shells rather than beams to represent flanges, stiffeners and cross-members often pays back.

In this example, the manual calculations to [10] clause 9.6.4.1.3 had revealed that the connection between cross-members and main girders was effectively rigid by comparison to other parts of the U-frame. In other cases, that approach would result in an over-estimate of buckling loads, and so the flexibility should then be included in the model, by inclusion of suitable joint elements.

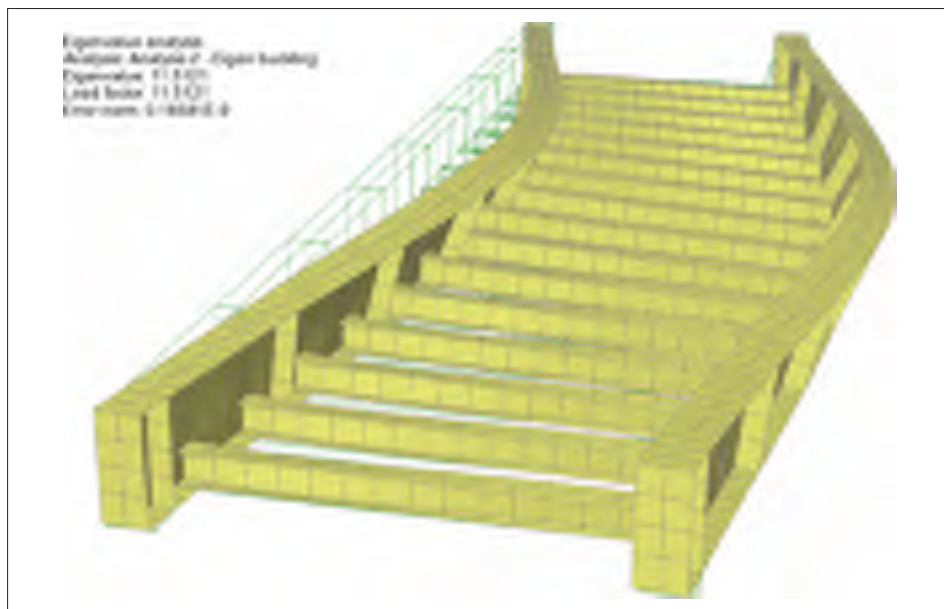


Figure 3 Lowest buckling mode from eigenvalue analysis of U-frame deck

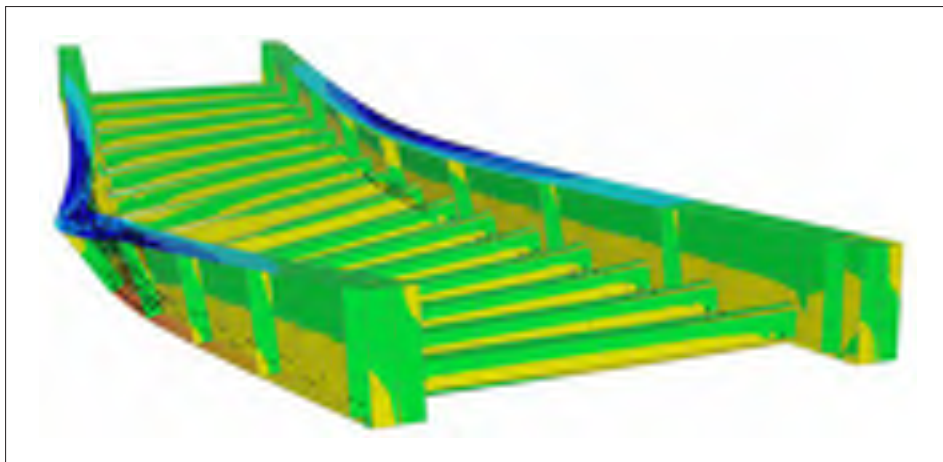
## 5 Nonlinear buckling analyses using FE

Moving beyond Eigenvalue analyses and codified approaches, a nonlinear analysis can provide an alternative means for assessing failure loads. This may be appropriate when unexpected behaviour has been highlighted by a prior Eigenvalue buckling analysis, when the structure or details are outside the scope of the code, or when the importance of the structure warrants further investigation, for example, a heavily trafficked existing structure where remedial works would be very costly and disruptive.

Models such as those in Figure 3 allow both local and global buckling modes to arise and therefore are a suitable starting point for a full nonlinear analysis. Crucially, such an analysis must take into account material plasticity, initial imperfections and second-order effects. It may also incorporate lift-off at bearings in skew structures, slack connections and other structure-specific issues such as corrosion, as necessary.

The results from a full nonlinear analysis for the example U-frame deck of Figure 2 gave a buckled shape as shown in Figure 4, and indicated a failure load 70% greater than that determined using the manual method of calculation of BS5400-3 [10] clause 9.6.4.1.3. Similar improvement in capacity was found by Hendy et al [11].

Material plasticity is readily added to FE models when using software with the appropriate facilities such as LUSAS. Steel materials have significant strain hardening beyond yield, and ideally this should be incorporated in order to give represent the behaviour of the structure well. However, post-yielding behaviour is “sensitive to gauge length type effects” (CIRIA C664 [12] section 7.7.5) and so a conservative strain hardening slope should be adopted.



**Figure 4** Buckling with yielding, from nonlinear analysis of U-frame deck

Regarding initial imperfections, these are also readily incorporated and can have a significant effect on the analysis results – this underlines the limitation of codified buckling rules to members fabricated and erected to modern tolerances, and the possible need for nonlinear analysis to be used for members not meeting such standards. EN1993-1-1 [4] suggests using the shape of the elastic critical buckling mode as an imperfection when second-order analysis is used (see clause 5.3.4) with the amplitude based on the section in question (see Table 6.2 and Table 5.1 in conjunction). Broadly speaking, the imperfections are of order span/150, or span/300 for heavy bridge sections if LTB is concerned. These values – significantly greater than expected fabrication tolerances – incorporate an allowance in lieu of residual stresses, locked-in during fabrication. For existing structures NR-GN-CIV-025 [9] clause 9.12.1A requires initial imperfections corresponding to 1.2 times the measured out-of-straightness of the compression flange – the 1.2 factor allows for residual stresses. If the bow in the flange is not measured, but instead the construction and fabrication tolerances from Codes or drawings are used, the imperfection should be based on a larger factor, perhaps twice the stated tolerance (CIRIA C664 [12] section 7.7.3).

Use of an incremental-iterative approach with geometric nonlinearity should ensure that second order effects are fully incorporated (LUSAS [13], Chapter 3).

Partial factors can be conveniently applied to the results from nonlinear analyses (rather than within nonlinear material properties, for example). This is over-conservative for buckling analyses, being equivalent to applying the partial factors to the elastic modulus of the material as well as the strength. However, it is noted by CIRIA C664 [12] to be “rigorously safe and simple”.

## 6 Conclusions

The elements used in FE buckling analyses might comprise shells, beams or a mixture. In general, shell elements are recommended. In all cases, mesh refinement should be checked. Elastic critical buckling loads may be obtained from eigenvalue buckling analyses and used for member resistance calculations using codes of practice. This has particular application for non-standard members such as existing structures.

Nonlinear analysis may also be used to assess member resistances. Initial imperfections need to be included in such analyses and eigenvalue buckling mode shapes typically provide a suitable imperfect shape.

Eigenvalue buckling analyses can also be used to investigate the susceptibility of any girder system to second-order effects or stability issues.

Nonlinear analysis is recommended by NCHRP Report 725 [1] and EN1993-1-1 [4] clause 5.2.1(3) for girder systems with a large amplification factor ( $AF_{\phi}$ ), or for which lift-off may occur. Such analyses can be readily undertaken, utilising the same analytical models constructed for a prior eigenvalue buckling analyses.

## References

- [1] NCHRP Report 725: Guidelines for Analysis Methods and Construction Engineering of Curved and Skewed Steel Girder Bridges, Transportation Research Board, Washington DC 2012.
- [2] Galambos, T.V. (ed): Guide to Stability Design Criteria for Metal Structures, John Wiley & Sons, Inc, New York, p. 134, 1998
- [3] Yura, J., Widiyanto, B.O.: Lateral Buckling and Bracing of Beams—A Re-Evaluation after the Marcy Bridge Collapse, Annual Technical Session of the Structural Stability Research Council, 2005, Montreal, Quebec, Canada, Structural Stability Research Council, Rolla, MO, pp. 277-294, 2005
- [4] EN 1993-1-1:2005: Eurocode 3: Design of steel structures – Part 1-1: General rules and rules for buildings, British Standards Institution, London, 2005
- [5] Yura, J., Helwig, T., Herman, R., Zhou, C.: Global Lateral Buckling of I-Shaped Girder Systems, Journal of Structural Engineering, vol.134, no.9, pp. 1487-1494, 2008
- [6] LUSAS: Element Reference Manual, FEA Ltd, Kingston-Upon-Thames, 2015
- [7] SN001a: NCCI – Critical axial load for torsional and flexural torsional buckling modes, Access Steel/ SCI, Ascot, 2008
- [8] SN003b: NCCI – Elastic critical moment for lateral torsional buckling, Access Steel/ SCI, Ascot, 2005
- [9] NR-GN-CIV-025: Guidance Note – The structural assessment of underbridges, Issue 3, Network Rail, London, 2006
- [10] BS5400-3:2000: Steel, concrete and composite bridges – Part 3: Code of practice for design of steel bridges, British Standards Institution, London, 2001
- [11] Henty, C., Denton, S., MacKenzie, D., Iles, D.: EN1993 Practice Paper: Buckling analysis of steel bridges, Bridge Design to Eurocodes – UK Implementation, ICE Publishing, 2011
- [12] CIRIA C664: Iron and steel bridges – condition appraisal and remedial treatment, CIRIA, London, 2008
- [13] LUSAS: Theory Manual 1, FEA Ltd, Kingston-Upon-Thames, 2015



## 16 POWER SUPPLY OF TRANSPORT SYSTEMS







## PROBLEMS OF ELECTRICAL SAFETY IN DEPOTS AND WORKSHOPS FOR SERVICING ELECTRIC TRACTION VEHICLES

Tadeusz Maciolek, Adam Szeląg

*Warsaw University of Technology, Faculty of Electrical Engineering, Poland*

### Abstract

Electric rolling stock workshops and depots are to be prepared for service of modern rolling stock, typically equipped with power electronic converters and in a case of railway vehicles with a multi-system as well. Presence of catenary, which is supplied by DC or AC voltage, and need to supply wagons by different voltages and use of typical low-voltage 230/400 V 50 Hz installations pose some obstacles due to different requirements towards electric shock protection in AC and DC systems. For DC systems in a catenary/pantograph zone bonding as a protection measure is applied and rails are not to be straight-line grounded due to a stray currents flow, while for AC catenary and in-door electric installations earthing is required. The safety of personnel during normal and emergency operation cases is a pre-requisite of any type of solution, which is to be applied in that kind of areas. So the allowed level of touch voltage is reduced both during a long-term (permanent voltage drops) and short-term (over-voltage, short-circuits) period, furthermore the presence of mix AC and DC components is to be taken into consideration acc. to the EN 50122-3 standards. The technical infrastructure spread-out in depots could cause an unexpected current flow through hidden elements as well as appearance of dangerous potential. In order to reduce possible occurrence of such cases during exploitation it is required, at a design level to undertake a detailed study of methods to assure safety. Additionally tests upon completion of the installation are to be performed as well. The paper presents safety measures implemented in a newly build depot of electric rolling stock in Poland. The paper discusses the problems of electric shock-protection coordination in depots and workshops of electric traction vehicles. Furthermore, the results of analysis of electric shock voltage under normal and different fault conditions of operation are described. A multi-track model of a return network was applied in the analysis, which allowed assessing values of maximum voltages which could appear during fault conditions. A study-case of a protection system for devices and installation requiring grounding or bonding, whilst maintaining isolation of rails from earth has been presented as well.

*Keywords: tram, electric shock-protection, catenary, depots, earthing*

### 1 Introduction

In the halls used for servicing electric rolling stock one might come across potential dangers from DC constant and AC alternating voltage. There are catenaries supplied with 600 V constant voltage for trams or with 3 kV for trains. Installation and devices with 230/400 V 50 Hz supply are also used. The DC traction supply system requires structures in a danger zone to be bonded. Both AC installations and structures inside the halls need to be earthed as well. At the same time, rails of the tracks shall be isolated from earth in order to provide protection against stray currents [2]. Technical requirements for an electric traction supply system, which is implemented by an overhead contact line and a return network, pertain to, among other

things, safety of personnel and reduction of negative influence on devices and elements of infrastructure in the area of electrified transport system (short-circuits, effective touch voltages, voltage drops, EMC, stray currents).

## 2 Permissible line-to-ground voltages

To ensure safety of both personnel and electrical devices some restrictions are imposed on voltages and time of their occurrence in a rail return network and bonded elements in relation to the surrounding earth and the earthed parts. These restrictions ensue from the PN-EN 50122-1:2011 Standard [1]. As far as the workshops are concerned, a permissible long-term DC constant touch voltage is 60 V. Theoretically, during isolation failure, both constant and alternating voltages might appear. For such overlapping of voltages Standard [4] requires the presented below characteristics (Fig. 1) to be fulfilled. Higher voltages are permitted, however with shorter times.

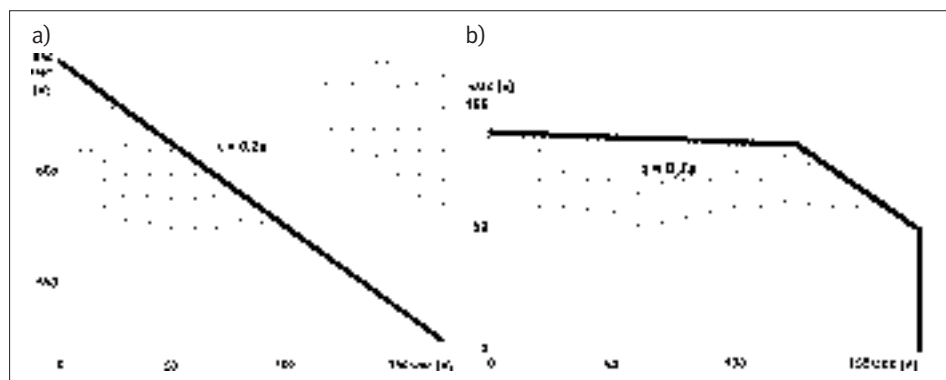


Figure 1 Example of permitted levels of AC and DC combined voltages for time a) 0.2 s and b) 0.7s [5]

Values of line-to-ground voltages depend on the values of maximum currents and resistance in circuits. In order to determine the parameters of current and voltage, it is required to develop a model of a supply system and conduct calculations [6, 7].

## 3 Exemplary model of a contact line for a multiple track system

In workshops of tramway traction supplied with 600 V system voltage occur higher traction currents than in railway workshops that are supplied with 3 kV system voltage. What is necessary for extensive track systems is an analysis of currents and voltages that might appear between the rails and earth, which would be conducted by means of a complex model [6, 11]. Normal and emergency (short-circuit) operation conditions are subject to analysis. Exemplary 10-track model for a tram hall is presented in Fig. 2. The model includes the parameters of a substation, traction feeders and return cables as well. Rails of the electrified tracks might be electrically connected in a permanent manner with tracks' rails in the area outside the hall. Such solution eliminates the need of using separated rectifier units for the tracks in a hall. Thus, both operational currents and short-circuit currents can flow through the tracks in the hall and outside the hall. Voltage level between the rails of electrified tracks and the earthed elements or earth is the basic criterion that is determined during the analysis. The adopted system of rails that are isolated from earth causes changes in voltage to earth, depending on the values of currents and their flow path. Due to this fact the analyses are conducted for the least favourable cases of return system emergency operation. The results of calculations per-

tain to voltage between the analysed track point in the hall and the negative bus of a traction substation. In the present case two operating states have been examined:

- emergency mode operation (unlikely) – when only one return cable connected to a hall’s track system operates. Resistance of a hall’s earth electrode is considerably larger than the resistance of a substation’s earth electrode and rail-to-ground leakage resistance.
- normal mode operation – when in the area of a depot all return cables operate. Resistance of a hall’s earth electrode is compliant with the project, lower than or comparable to the substation’s earth electrode resistance.

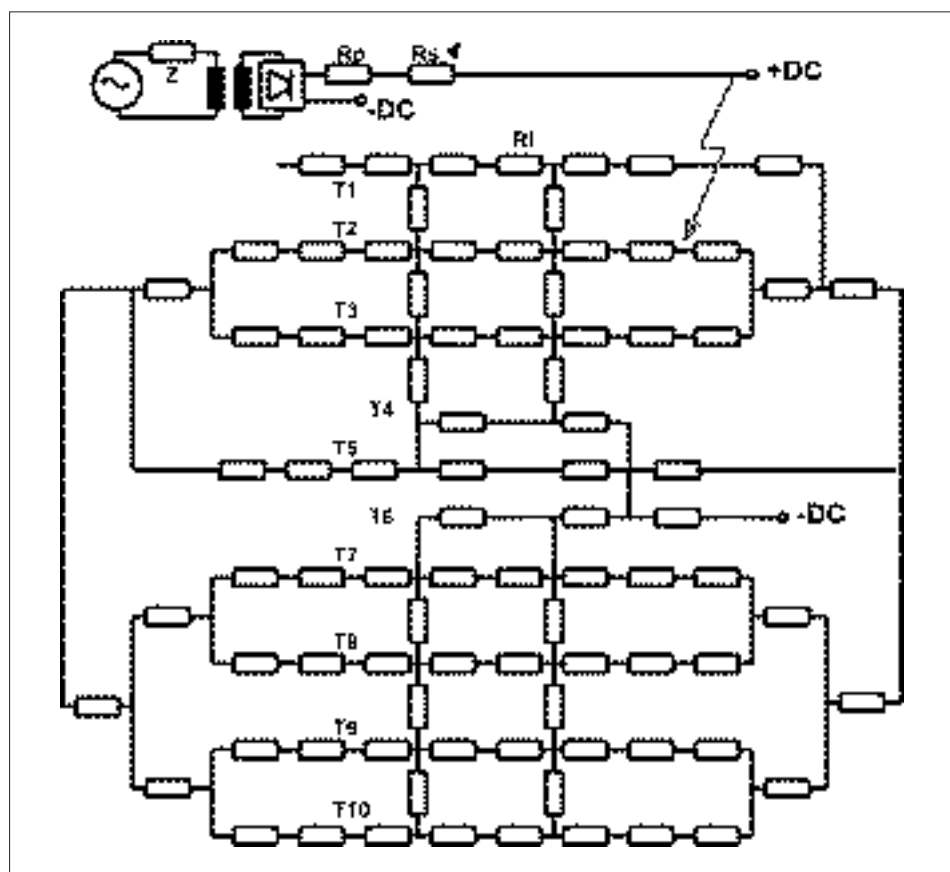


Figure 2 Diagram of the power supply system of the analysed 10-track (T) tram depot and hall

### 3.1 Normal operation mode (load)

In the state of load, currents flowing in all tracks, both inside and outside the hall, influence the voltage levels. Influence of tram currents (outside the hall) is limited and dispersed. For the purpose of the analysis one has assumed an extreme case, in which hall’s tracks are connected to the negative buses of a traction substation only with one return cable. Impact of trams outside the halls has been omitted. However, current flowing in the analysed track is the most important element. Current consumed by one tram depends on a ride phase and tram’s speed. Speed limit to several km/h and acceleration limits in the area of a depot results in current limits – current consumed by one tram shall not exceed 400 A.

During the analysis, one included a borderline case of simultaneous start-up of 2 trams and a flow of standstill currents of 4 trams, which has increased current up to 1000 A. Voltage levels between the tracks' rails and earth for alternating current of 1000 A in each case, under the most unfavourable conditions with only one return cable operating, have the value of 11 V. In a normal operation mode of the power supply system (two return cables operating), this value is several times lower. Voltages are therefore lower than the allowable continuous voltage of 60 V.

### 3.2 Short-circuit mode – cleared by a high speed breaker (HSB) and a convection power breaker

Metallic short-circuits are characterised by a rapid increase of current with time constant of a dozen of milliseconds. When operating properly, high speed breakers can limit the maximum value of current to approx. 4 kA. Short-circuit clearance occurs in less than 0.1 s. Results of voltage levels between the tracks' rails and earth for alternating current of 4000 A in each case, under the most unfavourable emergency conditions, have the value of up to 45 V. They are also lower than the allowable continuous voltage of 60 V. Current of a metallic short-circuit can reach a set value in a case of high speed breaker failure (lock). Due to high values of power supply system short-circuit power and expected simultaneous operation of rectifier units under steady states, these currents can exceed 20 kA. High speed breaker that does not operate properly (closed) limits the maximum value of current only to a small extent and does not stop its flow. These phenomena are of changeable nature, hence it is difficult to estimate influence of such a breaker on the value of steady-state current. For this case the analyses of short-circuit current values have been assumed as for the metallic short-circuit, and without a limiting effect. Switching off of power supply takes place using a power breaker (PCB) on the side of alternating current in less than 0.2 s. Fig. 3 shows an exemplary initial process of short-circuit that is cleared by a power breaker when there is a failure of a high speed breaker.

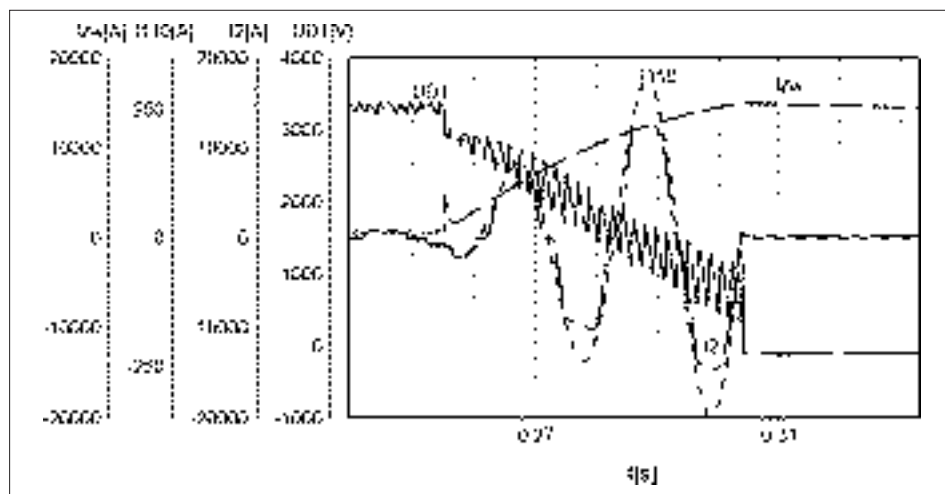


Figure 3 Exemplary waveform of  $I_{zw}$  short-circuit current with a faulty high speed breaker (HSB) (short-circuit clearance by a power breaker (PCB) on the AC side of substation supply – 110 kV 50 Hz – current I110)

For this case one has conducted an analysis of borderline states. The obtained results of voltage levels between tracks' rails and earth for short-circuit with a steady current for all the cases are up to 195 V, with duration time of 0.2 s (under the most unfavourable emergency conditions). The analysis and calculations of the system have been conducted in an exem-

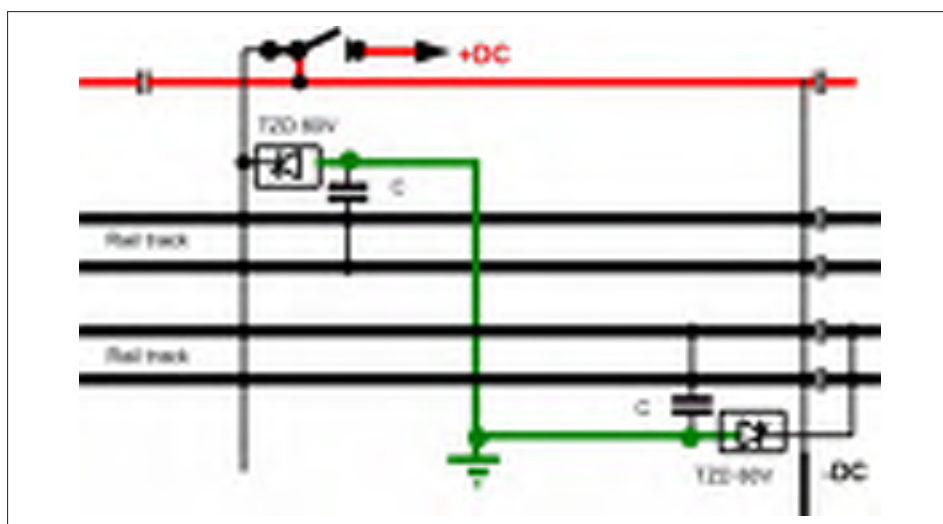
plary hall, with all return cables operating (normal operation mode), and they showed that voltage between a short-circuit point and a negative bus of a substation is 66 V. Upon taking into account distribution of line-to-ground voltages in relation to local earth, voltage shall not exceed the value of 33 V. Voltages, both in the normal and emergency operation mode, have lower values than the permitted value of 245 V for a duration time of 0.2 s. In order to reduce voltages between rails and earthed structures, it is required to connect earthing circuits with the rails by means of limiters. When operating in the emergency mode, voltage between the rails and earthing in the hall shall activate an electronic limiter TZD, thus reduce voltage to 2 V in 1 ms.

### 3.3 State of short-circuit to earthing circuit

In case of a short-circuit of an overhead contact line to elements connected to earthing (insulator failure), line voltage of 600 V or 3 kV might appear at certain points of the structure. When voltage exceeds 60 V, an electronic voltage limiter of TZD type shall be activated, as in case of the system presented in Fig. 4, and voltage in the structure will be reduced to 2 V in 1 ms. Until tripping of a limiter thyristor (time up to 1 ms), voltage is limited to the level of approx. 300 V by varistors [3].

Permitted voltage for time of less than 20 ms is 870 V. Earth fault shall also activate electronic earth fault protection (EZZ). In a traction substation, when voltage between a rail and an earth electrode is too high, the EZZ closes the negative rail with the earth electrode (activation range from 80 to 140 V DC). In the event of continued earth fault (not cleared by an appropriate high speed breaker), the EZZ forces the power breaker to disconnect rectifier units of a traction substation.

Maximum voltage between the rails in a hall and earth, and earthed elements during normal operation of a return power supply system does not exceed 60 V, regardless the values of current. It pertains to the states of load, but also to short-circuits that are cleared or not by a high speed breaker of a feeder. In such conditions, the electronic voltage limiter of a TZD type between the rail system and earthing will not trip. Isolation between earthing and rails will remain unchanged; hence the flow of stray currents will not be possible. Fig. 4 shows the proposed protection connections system with the use of TZD limiters.



**Figure 4** Example of a protection system employing low-voltage limiters for tracks and the earthing circuit in the hall

Such solution also provides protection for halls and devices in the case of a current flow from lightning discharge. Such discharge might take place to a hall's structure or nearby supporting structures of catenary outside the hall. It is necessary to take into account the possibility of several cases of lightning discharge during a year. When a lightning discharge occur – direct lightning strike – current of the main channel is typically 100 kA. Discharge time is several tens of  $\mu\text{s}$ . Even when the flowing current is that high, a varistor inside the limiter decreases voltage to approx. 300 V. Voltage limiters TZD are, in most cases, a second, additional level of protection, since the high speed breaker and power breaker provide a sufficiently rapid solution for switching off power supply. They constitute a primary way for limiting a voltage level in the event of failure of the basic protection, earth fault in the hall and lightning discharge that occur in close proximity.

#### 4 Connections of a traction return network in a hall

Solutions that have been widely used in the halls and workshops consist in isolation of the rails from track systems outside the hall and their direct earthing. Such approach resulted from the need to use earthing for electric circuits, housing of devices and hall's structures. The quality of hall's rails isolation from rails on the outside decreases. When the train is entering the hall, short-circuit of the hall's earthing system with the rails on the outside occur. In order to avoid that, rails are switched over in the hall. These solutions are unreliable. Currently, it is also possible to directly connect the electrified tracks' rails with tracks' rails outside the hall. Due to electric corrosion in DC current traction systems, rails, as the elements of the return circuit, are isolated from earth, and in this case, they are also isolated from earth circuits, which provides protection against stray currents flow – according to the recommendations of the PN-EN 50122-2:2003 Standard [2]. Availability of electronic – thyristor TZD limiters [3] enables maintaining isolation between the rails of the traction system and earthed elements for the permissible voltage level. At the same time, the limiters provide a constant control of voltage between earth (earthing system) and rails. Exceeding permissible voltage will result in these circuits being closed by a thyristor. It is an element of protection against electric shock. Time of occurrence of voltage, which is restricted by varistors to approx. 300 V, before activation of the thyristor is approx. 1 ms. After interrupting the current flow, the limiter returns to a state, in which it provides isolation for these two circuits.

Non-traction electric devices and structures in the hall shall be earthed. The earthing system should not be directly connected with a traction rails system. Capacitor's capacitance of several  $\mu\text{F}$  will provide such flow of AC current so a residual current device operates properly. This breaker will switch-off a device supplied from a 50 Hz network in a case of an isolation breakdown and flow of current to the rails. Capacitor's capacitance depends on the required value of residual current.

#### 5 Conclusions

The paper discusses problems of electric shock-protection coordination in depots and workshops of electric traction vehicles supplied by DC voltage. Some exemplary safety measures implemented in a newly build depot of electric rolling stock in Poland are presented. Results of analysis of electric shock voltage under normal and different fault conditions of operation are described. A multi-track model of a return network was applied in the analysis. Assessment of values of maximum voltages, which could appear during fault condition has been performed with comparison to proper safety standards. A study-case of a protection system with application of electronic earth fault protection for devices and installations requiring grounding or bonding with assuring isolation of rails from earth during normal operation is presented. The results of analysis confirmed effectiveness of the applied solutions.

## References

- [1] PN-EN 50122-1:2011 – Zastosowania kolejowe – Urządzenia stacjonarne – Bezpieczeństwo elektryczne, uziemianie i sieć powrotna – Część 1: Środki ochrony przed porażeniem elektrycznym
- [2] PN-EN 50122-2:2003 (U) – Zastosowania kolejowe. Urządzenia stacjonarne. Część 2: Środki ochrony przed oddziaływaniem prądów błędnych wywołanych przez trakcję elektryczną prądu stałego
- [3] PN-EN 60099-5:1999 Ograniczniki przepięć. Zalecenia wyboru i stosowania. (ze zmianą A1:2004)
- [4] PN-EN 50122-3:2011 – Zastosowania kolejowe – Urządzenia stacjonarne – Bezpieczeństwo elektryczne, uziemianie i sieć powrotna – Część 3: Oddziaływanie wzajemne systemów trakcji prądu przemiennego i stałego
- [5] Szelaż, A.: Obliczanie tramwajowej sieci powrotnej w celu zmniejszenia upływu z szyn jezdnych prądów błędnych. Konf. N-T “Trakcja elektryczna w komunikacji miejskiej “ TRAM’96, Gdańsk 9-11 V 1996, pp. 95-102
- [6] Drażek, Z., Mierzejewski, L., Szelaż, A.: Obliczenia metodami analitycznymi parametrów sieci zasilającej i powrotnej układów zasilania trakcji tramwajowej (2). Technika Transportu Szynowego 9/2001, pp. 25-33
- [7] Drażek, Z., Mierzejewski, L., Szelaż, A.: Metoda symulacyjna obliczania obciążeń sieci tramwajowej. Technika Transportu Szynowego 2/2002, pp. 66-76
- [8] <http://www.elester-pkp.com.pl/ezz.php>
- [9] Szelaż A., Maciołek T.: A 3 kV DC electric traction system modernisation for increased speed and trains power demand-problems of analysis and synthesis. Przegląd Elektrotechniczny 3a/2013, pp. 21-28
- [10] Szelaż, A., Mierzejewski, L.: Ground transportation systems (in) Encyclopaedia of Electrical and Electronic Engineering, Supplement I, John Wiley & Sons, pp. 169-194, 1999
- [11] Szelaż, A.: Применение моделей и технологий моделирования как методов для технико-экономического обоснования и проектирования систем тягового электроснабжения, Электрификация транспорта, pp. 56-65. 8/2014







# TIMETABLE OPTIMIZATION ON THE RAILWAY LINE ELECTRIFIED IN A DC POWER SYSTEM IN TERMS OF ENERGY CONSUMPTION USING THE PARTICLE SWARM OPTIMIZATION

Włodzimierz Jefimowski

*Warsaw University of Technology, Institute of Electrical Machines*

## Abstract

The paper presents the results of the investigation of timetable influence on energy consumption and peak power demand on a DC electrified railway. The aim of the investigation is to optimize a timetable in terms of energy consumption and costs. The original railway timetable was modified to insure the highest receptivity of the overhead catenary system (OCS) for the trains braking with recuperation. For this purpose the Particle Swarm Optimization has been used in connection with the program carrying out the parallel train performance calculations with the power flow calculation in the DC rail supply system with the recuperative braking. The optimization has been done taking into account the restrictions resulting from passenger waiting time.

## 1 Introduction

Energy saving is becoming more important for railway transport due to the growing prices of electric energy and environmental issues. Simultaneously it is known that traction energy is about 60-70% of the total energy consumption in railway [4]. Traction energy consumption could be decreased by improving the effectiveness of regenerating braking energy (RBE) utilization. Different methods are known to improve the effectiveness of regenerative braking energy recapturing, they could be divided into three groups [4]:

- Involving the energy storage devices (ESD). The different solutions belonging to this group enables storing regenerative energy and utilizing it when it is needed. The wide and general overview of the different storage systems has been presented in [14]. The solution gives independence from the power source receptivity [4].
- Optimisation of train braking effort and the speed trajectory for a single vehicle [4][5][6][13][21]. The subject has been investigated for last the two decades. In the number of papers different solutions in terms of methodology have been found. Various methods of artificial intelligence have been applied to find an optimal train speed trajectory.
- Improving the receptivity of the power source. This could be achieved via equipping a traction substation with an inverter to transfer energy to AC grid [9]. The second feasible method is timetable optimisation. The topic has been investigated for decades and much more intensively for the last few years [15][16][20]. The next chapter presents a literature review for this solution.

## 2 Literature review and aim of the research

The train timetable is a schedule of train traffic which is crucial to maintain the efficiency of transport service. Timetable influences many important economical, technical and environmental aspects. Since 1971 the timetable optimisation problems have been undertaken

and a number of timetable optimisation models with different objectives have been applied. Many of different objectives of the timetable optimisation have been defined and a large number of optimisation models have been developed as well. Particularly the objectives: trip time [11], passenger waiting time [7], delay time [8], energy consumption [12]. Concomitantly the energy consumption has become more important factor in the last decade, thus more researches have been undertaken to solve the timetable optimisation problems in terms of energy consumption. The aim of the studies is to create the timetable which enables synchronizing of drive modes of different trains operating on the same supply section in order to improve source receptivity from the point of view of braking trains. In [12] the optimisation model based on a Genetic algorithm has been created. The pilot model of the railway system contains an electrified double track line with three power substations, six train stops and four trains operating. The timetable has been modified according to the Genetic algorithm result by shifting the reserve time. In [15] the timetable optimisation in terms of regenerative energy recovery has been done. The developed model enables modelling the transfer of regenerative energy not only between adjacent trains, but among all trains. The strategy of the timetable optimisation does not depend on the section length. The regenerative power could also be drawn not only by the accelerating trains but also by all trains on the supply section. However the model has the constant number of trains and all of the trains are the same type. For last few years the timetable optimisation has been more often considered as a multi-objective problem. More than one aspect is being considered as the objective in optimisation models. For example in [1] two-objective optimisation is considered as a manner, to increase the efficiency of recuperation and to shorten the passenger waiting time. The aim of optimisation from the point of view of the first objective is the improvement of synchronisation between trains in up and down direction. In [20] the variation of passenger flow at stations is being considered, the concept of passenger waiting time is proposed and taken as the optimisation objective. The second objective is energy consumption and an iterative speed profile generation approach has been developed to find the energy-efficient speed profile. The proposed timetable optimisation model is two objective optimisation. The first objective is the minimum energy consumed by power substations. The second is maintaining the condition of the passenger flow alleviation without increasing the maximum passengers waiting and travel time. The result of the investigation is the timetable optimisation in terms of maximisation of regenerative energy flow among trains operating in the considered railway line and simultaneously maintaining passenger waiting time that is not longer than the original timetable. The timetable is modified by changing departure and arrival times at the stations as it is shown in Figure 1. The simulation model includes occurrence of random variations in railway traffic, especially the station dwell time and occurrence of unplanned train stops and speed reductions which are described by a random variation. The parameters of the random variations are prepared based on the statistic data from the railway operator. The random variations have been introduced to the model in order to improve the accuracy of the model. The Particle Swarm Optimisation is applied as an optimisation tool. The investigation considers a case study with a double track railway line electrified in a 3 kV DC system with different types of train operation. The case study is based on the original timetable taken from a Polish railway operator. The timetable has been modified according to the optimisation algorithm operation result.

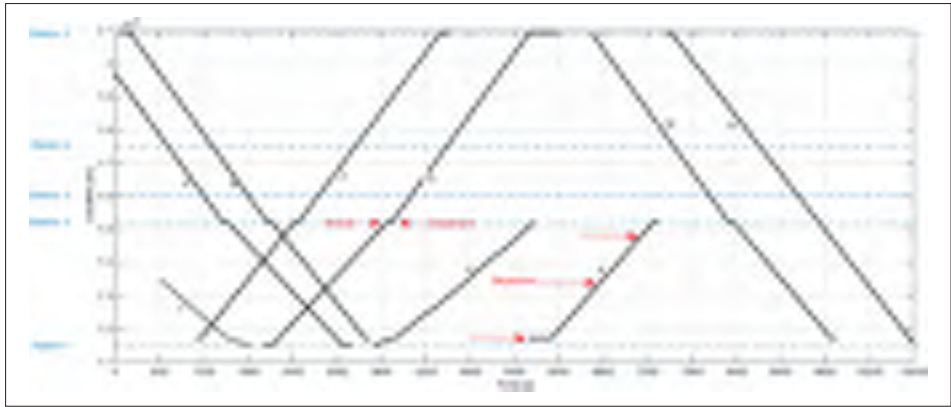


Figure 1 Graphic timetable with modified variations

### 3 Simulation model description

The tool applied for the purpose of the research is a complex simulation model of an electrified railway line. The general scheme of the model is presented in Figure 2. The program enables simulation of regenerative braking of trains. In the program there are no limitations in terms of a number of trains, substations and train stops as well as track length. The simulation program consists of the layer of parallel train performance calculation (1) which gives the location and the power value of each train operating on the modelled line. The algorithm is based on the set of equations 1:

$$\left\{ \begin{array}{l} \frac{dv(t)}{dt} = \frac{F(v(t), U(t)) - W(v(t), s(t))}{m(1 + \eta)} \\ P(t) = F(t) \cdot v(t) \end{array} \right. \quad (1)$$

These values are necessary as input data to the algorithm of the power flow and pantograph voltage calculations (2). Due to the nonlinearity of the loads as electrical elements there is need for using the iterative method to solve the circuit. Therefore a simple iterative method is used in connection with a superposition method [17][18][19]. In case when the overhead catenary system OCS is not fully receptive from the point of view of braking trains the algorithm of the iterative subtraction of the regenerative current is being operated. Pantograph voltages cannot exceed the maximum permissible value given in standard EN 50163, in case of a 3 kV DC system – 3900 V.

On Figure 2 the input data necessary into insert to the program is shown. The input data includes the vertical profile of the track, which influences on the regenerative braking profiles of trains.

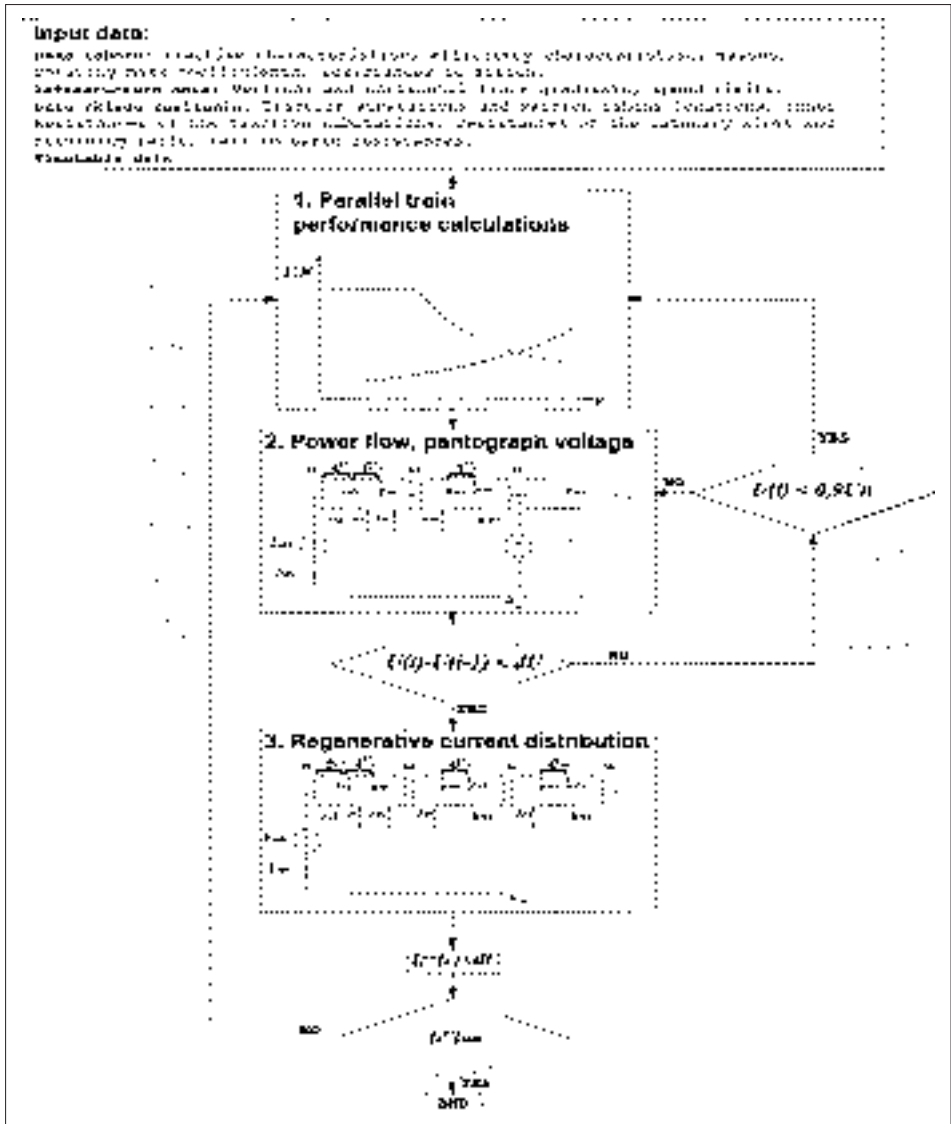


Figure 2 General scheme of the optimisation program

#### 4 Particle Swarm Optimisation algorithm (PSO)

The general scheme of the Particle Swarm Optimisation is shown in Figure 3. [3] In the first step the initial positions and velocities of the established number of particles are being found. During the second step the objective functions are being calculated for each particle position in a multidimensional space of variables. During this step the energy consumption is being calculated by the program described in Chapter 3 for each particle, where the variables are the parameters of a timetable – departure and arrival times. In the next step the best solution for each particle and for all particles, for all previous PSO algorithm iterations are being recorded.

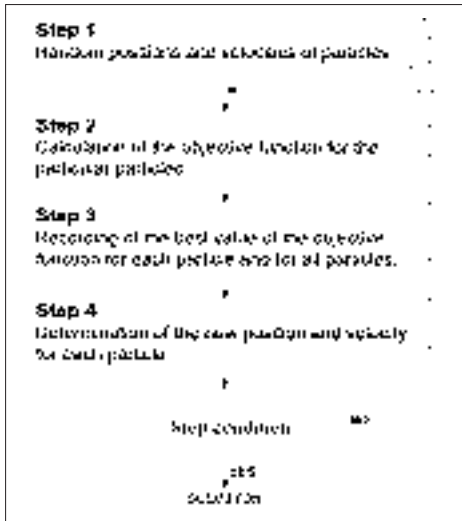


Figure 3 General scheme of a PSO algorithm

In step 4 the new velocities and locations are being calculated according to the Eq. 2 and 3 [3]:

$$v_k^{t+1} = c_0 r_0^t v_k^t + c_1 r_1^t (y_k^t - x_k^t) + c_2 r_2^t (y_k^{p^{tt}} - x_k^t) \quad (2)$$

$$x_k^{t+1} = x_k^t + v_k^{t+1} \quad (3)$$

Where:

- $r_0^t, r_1^t, r_2^t$  – random figures from the interval (0,1),
- $v_k^t$  – particle velocity in the previous step and in k-dimension,
- $x_k^t$  – particle coordinate in the previous step and in k-dimension,
- $y_k^t$  – particle coordinate in the location where the value of the objective function is the best till current step,
- $y_k^{tt}$  – coordinate in the location where the value of the objective function is the best for all particles till current step,
- $c_0$  – coefficient determining the influence of the particle velocity on its own velocity in the next step
- $c_1$  – coefficient determining the influence of the best particle location on its velocity in the next step
- $c_2$  – coefficient determining the influence of the best location found till current step among all particles on the particular particle velocity in the next step.

The optimisation algorithm includes two objectives. The first one is the minimum energy consumption. The second is maintaining the passenger waiting time, so it is not longer than before the timetable modification.

## 5 Timetable influence on the energy consumption.

The current chapter presents the results of simulations carried out on the program presented in Chapter 3. The operation of a 5 car electric multiple unit with regenerative braking is implemented. Two variants of simulations in terms of a section length have been done:

- 1) The double track line of 50 km length has been modelled with 12 train stops. Section busbar short circuit brakes are closed. Infrastructure data shown in Table 1. (Option 1)

- 2) The double track line of 12,5 km length has been modelled with 4 train stops. Section busbar short circuit brakes are opened, with train stops shown in Table 1. (Option 2)

In the first case the data of infrastructure implemented into the program is presented in Table 1. The line is electrified in a 3 kV DC system with 5 power substations and 4 section cabins. Figure 4 shows the instant values of substation power against time for the first option. Figure 5 shows the timetable of the trains implemented into the program with shift time between directions.

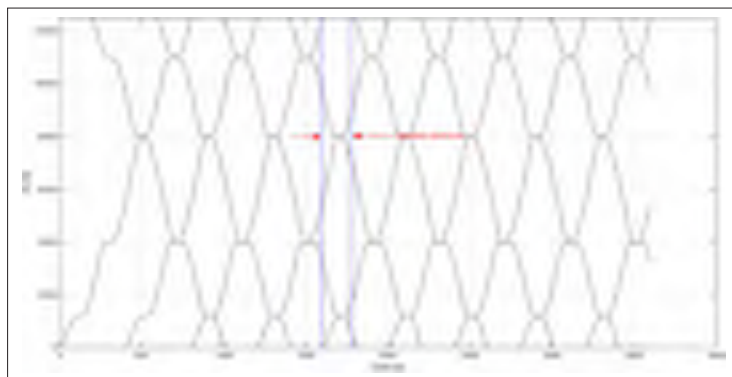
**Table 1** The infrastructure data

Train stops locations [m]	Power substations locations [m]	Section cabins locations [m]
1200, 4000, 8000, 12000, 15243, 21000, 24003, 29879, 35923, 43043, 45092	0, 12500, 25000, 37500, 50000	7000, 21000, 32000 43000

The train operation with headway time of 400 s in both directions has been modelled. Train stops have been modelled with different dwell times. The number of simulations has been made with different shift times between directions.



**Figure 4** Instant power of substations against time



**Figure 5** Implemented timetable of multiple units operation

Figures 6 and 7 show total energy consumed by power substations as a function of shift time between directions of traffic.

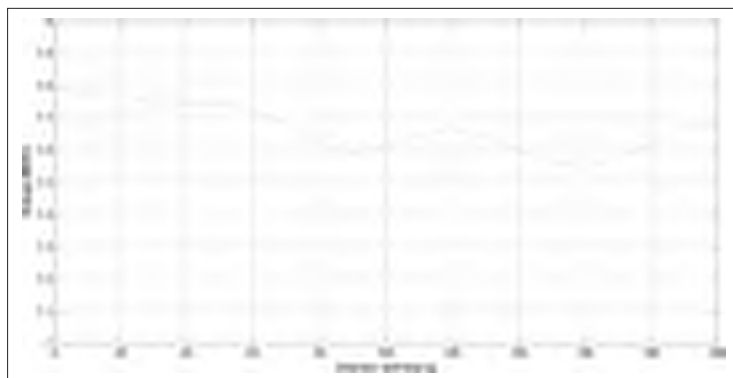


Figure 6 Energy consumption as a function of shift time between directions for option 1

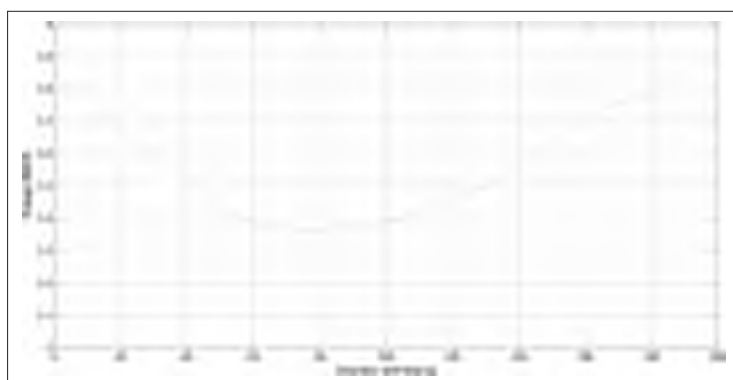


Figure 7 Energy consumption as a function of shift time between directions for option 2

## 6 Conclusions

The proposed timetable optimisation method provides the possibility of achieving more effective and accurate solution than the current solutions due to elimination of the train number limitations, stops and power substations as well as the implementation of random factors in trains operation. The model involves different types of trains including passenger, suburban and freight trains. Initial simulation results show that total energy consumption differs on the shift time between directions more in case with a short supply section than with a long one. It proves that timetable optimisation is more effective in case with shorter supply sections and longer average headway times. Figure 7 shows that by the modification of shift time, the total energy consumption may be decreased by 12,4 %.

It should be noticed that energy consumption is the result of random varieties influence. Precisely for this reason the effect in terms of energy saving in a traction system should be estimated in a long term perspective, and considered with support of the statistics tools. The drawback of the presented solution is significant computation time, which takes several hours. The proposed process of the optimisation is based on the multiple operation of the program described in chapter 4 .



## Acknowledgements

Scientific work financed from the statutory activities of the Faculty of Electrical Engineering on Warsaw University of Technology under a dean's grant.

## References

- [1] Yang, X., Ning, B., Li, X., Tang, T.: "A Two-Objective Timetable Optimization Model in Subway Systems," in IEEE Transactions on Intelligent Transportation Systems, vol. 15, no. 5, pp. 1913-1921, Oct. 2014. doi: 10.1109/TITS.2014.2303146
- [2] Goh, S., Griffith, M., Larbi, K.: "Energy saving by using regenerating braking as normal train operation," Railway Traction Systems (RTS 2010), IET Conference on, Birmingham, 2010, pp. 1-4. doi: 10.1049/ic.2010.0041
- [3] Baczyński, D.: "Metody inteligencji obliczeniowej w elektroenergetyce" Prace Naukowe PW, Seria ELEKTRYKA, s.157, z. 145, 2013
- [4] Lu, S., Weston, P., Hillmansen, S., Gooi, H.B., Roberts, C.: "Increasing the Regenerative Braking Energy for Railway Vehicles," in IEEE Transactions on Intelligent Transportation Systems, vol. 15, no. 6, pp. 2506-2515, Dec. 2014. doi: 10.1109/TITS.2014.2319233.
- [5] Dominguez, M., Fernandez-Cardador, A., Cucala, A.P., Pecharroman, R.R.: "Energy Savings in Metropolitan Railway Substations Through Regenerative Energy Recovery and Optimal Design of ATO Speed Profiles," in IEEE Transactions on Automation Science and Engineering, vol. 9, no. 3, pp. 496-504, July 2012. doi: 10.1109/TASE.2012.2201148
- [6] Khmelnitsky, E.: "On an optimal control problem of train operation," in IEEE Transactions on Automatic Control, vol. 45, no. 7, pp. 1257-1266, Jul 2000. doi: 10.1109/9.867018
- [7] Nachtigall, K.: "Minimizing waiting times in integrated fix interval timetables by up-grading railway tracks," Eur. J. Oper. Res., vol 103, no. 3 pp. 610-627, Dec 1997.
- [8] Liebchena, C., Shachtebeckb, M., Schobel, A., Stiller, S., Prigge, A.: Computing delay resistant railway timetables," Comput. Oper. Res., vol. 37, no. 5, pp. 857-868, May 2010.
- [9] Henning, P.H., Fuchs, H.D., le Roux, A.D., Mouton, H.d.T.: "A 1.5-MW Seven-Cell Series-Stacked Converter as an Active Power Filter and Regeneration Converter for a DC Traction Substation," in IEEE Transactions on Power Electronics, vol. 23, no. 5, pp. 2230-2236, Sept. 2008. doi: 10.1109/TPEL.2008.2001882
- [10] Adinolfi, A., Lamedica, R., Modesto, C., Prudenzi, A., Vimercati, S.: "Experimental assessment of energy saving due to trains regenerative braking in an electrified subway line," Industrial and Commercial Power Systems Technical Conference, 1997. Conference Record, Papers Presented at the 1997 Annual Meeting., IEEE 1997, Philadelphia, PA, 1997, pp. 211-216.
- [11] Szpigel, B.: "Optimal train scheduling on a single track railway," in Operation Research. Amsterdam the Netherlands: North Holland, 1973, pp. 343-352.
- [12] Nasri, A., Moghadam, M.F., Mokhtari, H.: "Timetable optimization for maximum usage of regenerative energy of braking in electrical railway systems," SPEEDAM 2010, Pisa, 2010, pp. 1218-1221. doi: 10.1109/SPEEDAM.2010.5542099
- [13] Forsythe, J.B.: "Light Rail/Rapid Transit: New Approaches for the Evaluation of Energy Savings, Part I – Life-Cycle Cost from Synthetic Routes/Operational Models," in IEEE Transactions on Industry Applications, vol. IA-16, no. 5, pp. 655-665, Sept. 1980. doi: 10.1109/TIA.1980.4503848
- [14] Lu, S., Meegahawatte, D.H., Guo, S., Hillmansen, S., Roberts, C., Goodman, C.J.: "Analysis of energy storage devices in hybrid railway vehicles," Railway Engineering – Challenges for Railway Transportation in Information Age, 2008. ICRE 2008. International Conference on, Hong Kong, 2008, pp. 1-6.

- [15] Chen, E, Bu, B., Wenzhe, S.: "An Energy-Efficient Operation Approach Based on the Utilization of Regenerative Braking Energy Among Trains," Intelligent Transportation Systems (ITSC), 2015 IEEE 18th International Conference on, Las Palmas, 2015, pp. 2606-2611. doi: 10.1109/ITSC.2015.419 .
- [16] Su, S., Li, X., Tang, T., Gao, Z.: "A Subway Train Timetable Optimization Approach Based on Energy-Efficient Operation Strategy," in IEEE Transactions on Intelligent Transportation Systems, vol. 14, no. 2, pp. 883-893, June 2013. doi: 10.1109/TITS.2013.2244885
- [17] Szelaǳ, A.: Wpływ napięcia w sieci trakcyjnej 3 kV DC na parametry energetyczno-trakcyjne zasilanych pojazdów", Instytut Naukowo-Wydawniczy INW SPATIUM, Radom, 2013, s.1-158,
- [18] Szelaǳ, A., Mierzejewski, L.: Modelling and verification of simulation results in computer aided analysis of electric traction systems. VII Int. Conference "Computer in Railway" COMPRAIL'2000. 11-13 IX,2000, Bologna, s.599-610
- [19] Szelaǳ, A.: Zagadnienia analizy i projektowania systemu trakcji elektrycznej prądu stałego z zastosowaniem technik modelowania i symulacji. Prace Naukowe PW, Seria ELEKTRYKA, s.178, z. 123, 2002
- [20] Xiaoming, X., Keping, L., Xiang, L.: "A multi-objective subway timetable optimization approach with minimum passenger time and energy consumption" in Journal of Advanced Transportation, Jan 2016
- [21] Jianshao, H., Huawei, X., Zhiyuan, H., Linyi, H., Qunxing, L.: "Study on braking force distribution based on fuzzy control algorithm," 2015 IEEE Advanced Information Technology, Electronic and Automation Control Conference (IAEAC), Chongqing, 2015, pp. 1114-1119. doi: 10.1109/IAEAC.2015.7428732
- [22] Kennedy, J., Eberhart, R.: "Particle swarm optimization," Neural Networks, 1995. Proceedings., IEEE International Conference on, Perth, WA, 1995, pp. 1942-1948 vol.4. doi: 10.1109/ICNN.1995.488968



## 17 STRUCTURAL MONITORING





## STATIC AND DYNAMIC TESTING OF STEEL RAILWAY BRIDGE “SAVA”

Domagoj Damjanović, Janko Koščak, Ivan Duvnjak, Marko Bartolac  
*University of Zagreb, Faculty of Civil Engineering, Zagreb*

### Abstract

Due to the increase in traffic load, steel railway bridge “Sava” in Zagreb was strengthened in order to meet higher standard requirements. After the strengthening, experimental investigation of the bridge was conducted. Bridge “Sava” is a double-track railway bridge over 4 spans with total length of 306 m and width of 9.6 m. Static system of the bridge is a simply supported continuous beam which is strengthened by the arch in the main span (langer beam). The main span is 135.54 m long and the remaining three spans are 57.50 m, 57.96 m and 55.00 m long. Static and dynamic loading was performed using two 119.5 m long train compositions each consisting of locomotive (4 axles, 20.0 t per axle) and 8 freight wagons (4 axles, 19.95 t per axle). During the static testing trains were positioned in different locations on the bridge in order to achieve maximal inner forces and displacements. Displacements were measured at 30 measuring points and strains were measured at 16 measuring points. Within dynamic testing, modal parameters of the bridge (natural frequencies and modal shapes) were determined using operational modal analysis during ambient excitation. In addition, natural frequencies were determined from vibrations measured with robotic total station after train compositions pass by at various speed. Experimentally determined displacements, strains (stress) and modal parameters were compared to the corresponding numerical values obtained from the FE model of the bridge. Values of experimentally determined parameters presented in this paper are important for future monitoring of the structural health of the bridge structure.

*Keywords: static and dynamic testing, structural health monitoring, operational modal analysis, modal parameters*

### 1 Introduction

The railway bridge “Sava” was built in 1939 as a replacement for an old single-track railway bridge that was no longer able to sustain continuously increased traffic loads. Static system of the old bridge was a continuous truss girder over 8 spans with total length of 253 m, Figure 1 [1].

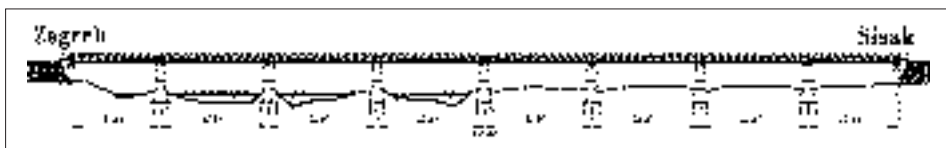


Figure 1 Old single-track railway bridge “Sava” [1]

The new bridge “Sava” is a double-track railway bridge over 4 spans with total length of 306 m and width of 9,6 m. Static system of the bridge consists of a continuous beam that is strengthened with arch in the main span (Langer beam). the link between the arch and the beam

is achieved by 28 vertical steel hangers. The main span is 135,54 m long and the remaining three spans are 57,50 m, 57,96 m and 55,00 m long, Figure 2 [2].



Figure 2 New bridge “Sava” before the strengthening

Due to the increase in traffic load, steel railway bridge “Sava” needed to be strengthened in order to meet higher standard requirements in relation to those when bridge was built (1939). After the strengthening of the bridge had been performed, the experimental investigation of its static and dynamic characteristics was conducted [3]. The experimental investigation was fully performed according to guidelines given in Croatian National Standard HRN U.M1.046 – Testing of bridges with test load [4].

## 2 Testing of the bridge with test load

The main objective of the conducted experimental investigation was to determine whether the bridge “Sava” could withstand increased traffic load imposed on it after the strengthening. In this chapter, a brief description of experimental investigation is presented and measuring points of the investigated parameters are shown.

### 2.1 Progress of the experimental investigation

Experimental investigation consisted of static and dynamic testing. All static tests were conducted under the traffic load, which was in the form of locomotives and freight wagons, Figure 3. During the static tests, trains were positioned in different locations on the bridge in order to achieve maximum inner forces and vertical displacements corresponding to those from the bridge design data. Basic parameters and brief description of train compositions used for static loading of the bridge are shown in Table 1. Static testing of the bridge was carried out through multiple phases of loading and unloading. Vertical displacements were measured in each phase by a method of geometric levelling and by a trigonometric levelling method, Figure 4.

Table 1 Length and masses of train compositions used for static loading

Number of compositions = 2					
Locomotive (per composition)			Wagons (per composition)		
Number	Length	Mass	Number	Length	Mass
1	15,5 m	80,0 t	8	13,0 m	79,8 t
Total length per composition		$15,5 + 8 \cdot 13,0 = 119,5$ m			
Total load per composition		$80,0 + 8 \cdot 79,8 = 718,4$ t			
Total load		$718,4 \cdot 2 = 1436,8$ t			



**Figure 3** Static testing of the bridge “Sava” – two compositions in the main span

During the static testing, strains in critical elements were measured via LVDT sensors and the data was collected with the HBM MGCPlus data acquisition system, providing continuous measurement with the adjustable sampling frequency. With that possibility strain measurement was conducted while compositions were moving across the bridge at low speed in order to identify the maximum values of inner forces occurring in the bridge elements.



**Figure 4** Vertical displacement measurement (left), data acquisition system (middle) and strain measurement sensor (right) on bridge “Sava”

Modal parameters (natural frequencies and modal shapes) were determined by means of operational modal analysis. Accelerations were measured in multiple measuring points on the bridge during ambient excitation, using accelerometers (PCB Piezotronics 393B31) – connected to the Bruel & Kjaer 3560C data acquisition system. Two accelerometers were used as reference, while the other two were moved through all measuring points. Acquisition and post processing of the data was conducted on PC with the Bruel & Kjaer “Pluse” software. Data post processing included Fast Fourier Transforms (FFT) and Frequency Domain Decomposition (FDD) of the time signal functions measured with accelerometers in order to obtain bridge modal shapes. Detailed explanation of data post processing procedure is shown in [5] and [6]. Unlike the operational modal analysis, determination of natural frequencies with the robotic total station is hardly achievable during the ambient excitation only. For that reason higher level of vibration of the bridge were produced by train passing over the bridge at various speed [7], [8].

It is important to note that the experimental investigation was fully performed according to guidelines given in Croatian National Standard HRN U.M1.046. Please note that not all of the performed tests and obtained results are shown in this paper. Rather, the presented results are limited to vertical displacements, strains in critical elements and modal parameters. Critical values of the measured vertical displacements and determined modal parameters are compared to the values obtained from numerical models, which are based on FEM [9].

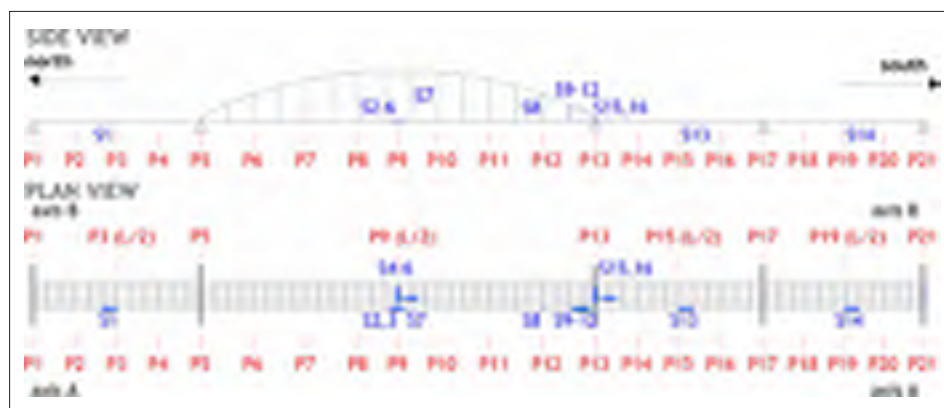


## 2.2 Investigated parameters

During the experimental investigation of the bridge “Sava” vertical displacements of the bridge were measured at 30 measuring points (namely, 21 measuring points along axis A and 9 measuring points along axis B), see Figure 5. Vertical displacements were measured by the modified method of geometric levelling and also by the trigonometric levelling method.

**Table 2** Measuring points for strain measurement

Measuring point label	Description of the measuring point location	
S1	MG1-LZ	Main girder, span 1, lower flange.
S2	MG2-LZ	Main girder, span 2, lower flange.
S3	MG2-UZ	Main girder, span 2, upper flange.
S4	CG2 – UZ	Cross girder, span 2, upper flange.
S5	CG2 – UZ2	Cross girder, span 2, upper flange.
S6	SLG2 – UZ	Secondary longitudinal girder, span 2, upper flange.
S7	HM	Hanger in the middle of the main span.
S8	H2	Second hanger.
S9	H1N	First hanger, north side.
S10	H1S	First hanger, south side.
S11	ARCH	Arch, span 2, south side.
S12	MG2C – UZ	Main girder, column between 2. and 3. span, upper z.
S13	MG3 – LZ	Main girder, span 3, lower flange.
S14	MG4 – LZ	Main girder, span 4, lower flange.
S15	SLG3C – LZ	Secondary longitudinal girder, span 3 – near column.
S16	CG2C – UZ	Cross girder, column between 2. and 3. span.



**Figure 5** Measuring points of static vertical displacements (red) and measuring points for strain measuring (blue)

Apart from vertical displacements, strains in critical structural elements were measured at 16 measuring points continuously during all phases of static testing of the structure. Measuring points for strain measurement were placed on main girders (6 measuring points), on the secondary longitudinal and cross girders (5 measuring points) and on the arch and hangers of the main, largest, span (5 measuring points), Figure 5 and Table 2.

Within determination of modal parameters (natural frequencies and modal shapes) using OMA, accelerations were measured at 42 points during ambient excitation. Additionally, natural frequencies of the bridge were determined from the vibration measured with the Robotic Total Station (RTS). Positions of the acceleration measuring points (1-42) as well as RTS measuring point are shown in Figure 6.

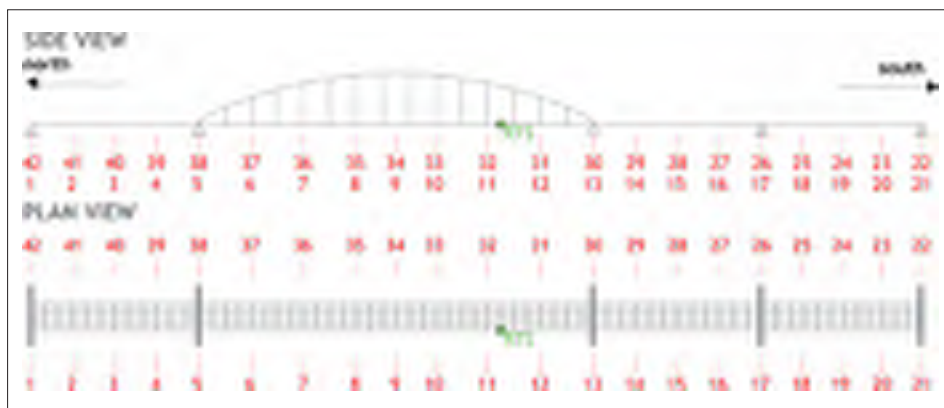


Figure 6 Positions of accelerometers and RTS measuring points

### 3 FEM modelling of the bridge

Vertical displacements and modal shapes obtained by experimental investigation are compared to those obtained from numerical model. Numerical model of bridge “Sava” was created in software CSI SAP2000 v18 based on Finite Element Method (FEM). Figure 7 shows numerical model of the bridge created with frame elements.

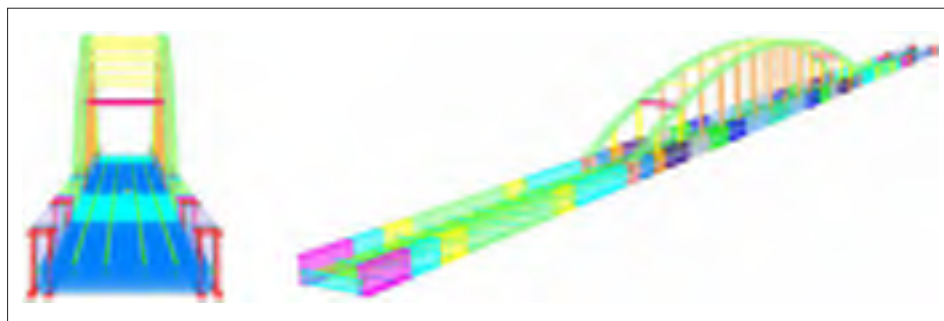


Figure 7 FEM numerical model of the bridge “Sava” – 3D view

In order to determine masses and positions of train compositions causing maximum inner forces and displacements of the structure, numerical models were made prior to experimental investigation. For all numerical models static and dynamic analysis was conducted. Within the static analysis, forces equal to those of train compositions were applied on to the numerical models. Analysis output in terms of vertical displacements is compared to experimentally obtained values and presented in this paper. Furthermore, dynamic analysis was conducted and dynamic parameters (natural frequencies and modal shapes) obtained from a numerical model are compared to measured ones.

## 4 Results

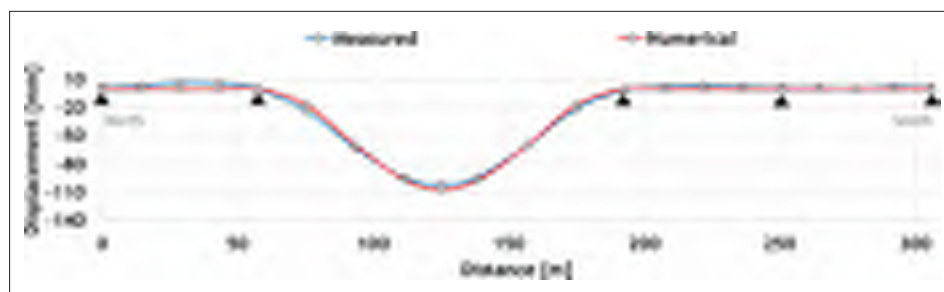
### 4.1 Vertical displacements

In this paragraph, maximum values of measured vertical displacements for each span of the bridge are compared to corresponding numerically obtained displacements. Residual values after load removal were also measured and shown below.

**Table 3** Comparison between measured and numerically obtained vertical displacements

Span	Measuring point	Measured value	Calculated value	Residual displacement
1	P3-A	45,0 mm	47,6 mm	2,0 mm
2-main span	P9-B	102,0 mm	107,0 mm	2,0 mm
3	P15-A	43,0 mm	49,0 mm	1,0 mm
4	P19-B	49,0 mm	51,2 mm	1,0 mm

Table 3 and Figure 8 show that results obtained from experimental investigation are similar to those obtained from numerical model. Maximum deviation between measured and calculated values is about 12 % (span 3). Maximum residual displacement is measured in spans one and two (2,0 mm), which is 4 % of maximum measured displacement in span 1 and 2 % of maximum measured displacement in the main span. Ratio between residual and maximum measured vertical displacements is below 15 %, which is maximum allowed value given in Croatian National Standard HRN U.M1.046 for steel structures.



**Figure 8** Measured and numerically obtained deflection curves for a load case with two compositions in the main span – max. vertical displacement

### 4.2 Strain measurement

Due to determination of cross section usability, strain measurement was conducted within the experimental investigation. Maximum measured strain value detected during experimental investigation was  $-0,3793 \text{ ‰}$  at measuring point S11-ARCH which is, from expression (1), stress of  $-79,7 \text{ MPa}$ . Continuous record of strain measured values during experimental investigation is shown in Figure 9. Stress estimation is calculated with the Hooke's law for one axial stress,

$$\sigma = \varepsilon \cdot E \quad (1)$$

where  $\varepsilon$  represents measured strain value,  $E \text{ [MPa]}$  is young's module of elasticity and  $\sigma \text{ [MPa]}$  represents calculated stress value. Expression (1) can be used if all sensors were placed in one axial stress zone, which is the case in this experimental investigation.

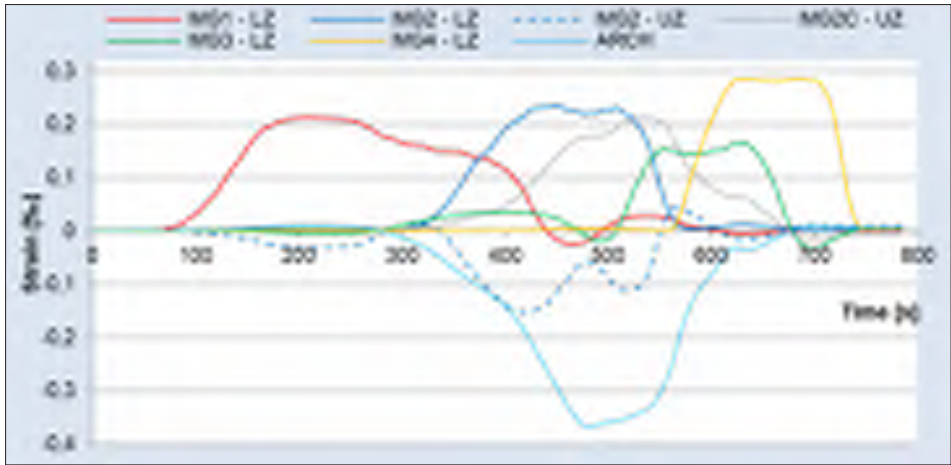


Figure 9 Continuous record of strain measured values during experimental investigation – measuring points on the main girder

### 4.3 Dynamic parameters

Natural frequencies of the bridge were determined from dynamic displacement measured by robotic total station (RTS) and with operational modal analysis (OMA). Fast Fourier transform (FFT) analysis was used to convert the time domain records of dynamic displacement measured by RTS to frequency domain. Natural frequencies were identified as resonance peaks of these spectral functions. Comparison between measured and numerically obtained values are shown in Table 4.

Table 4 Natural frequencies of the bridge “Sava”

OMA [Hz]	RTS [Hz]	Numerical model [Hz]
1,01	1,02	1,03
1,57	1,56	1,63
1,96	1,95	1,54
2,73	2,73	2,81

For each natural frequency modal shape was also determined by operational modal analysis, some of experimentally obtained modal shapes are shown below.



Figure 10 Modal shapes of the bridge obtained by operational modal analysis

## 5 Conclusions

The steel railway bridge “Sava” was strengthened in order to meet higher standard requirements in relation to those when the bridge was built. After the strengthening was done, experimental investigation of the bridge static and dynamic parameters was performed according to the guidelines given in the Croatian National Standard HRN U.M1.046 – Testing of bridges with test load [4]. The experimental investigation consisted of vertical displacement and strain measurement but also of dynamic parameters determination. Comparison between numerically obtained and measured values of vertical displacements shows high accordance in results. Furthermore, measured values of residual vertical displacements were below 15 % of the maximal measured values, which is maximum allowed ratio for steel structures given in the HRN U.M1.046 standard. Measured strain and estimated stress show that all critical structural elements of the bridge remain elastic during all phases of static tests. Maximal measured strain value was  $-0,379 \text{ ‰}$  which gives stress of 79,7 MPa or 22,5 % of yielding point value for steel S355 which is the main construction material of the bridge. Investigated dynamic parameters are of great importance for the future health monitoring of the structure. Dynamic parameters obtained from experimental investigation are within the expected range, which indicates that no damage occurred during the experimental investigation and that the strengthening of the bridge can be overall assessed as successful.

## References

- [1] Leko, V.: Iz povijesti graditeljstva, Građevinar, vol. 61, pp. 775–791, 2007.
- [2] Crnobrnja, N.: Zagrebački savski mostovi, Građevinar, vol. 21, pp. 977–985, 2005.
- [3] Rak, M., Damjanović, D., Duvnjak, I., Koščak, J.: Izvještaj o ispitivanju željezničkog mosta ‘Sava’, Sveučilište u Zagrebu Građevinski fakultet, Zagreb, p. 75, 2015.
- [4] HRN.U.M1.046, “Ispitivanje mostova probnim opterećenjem – HRN.U.M1.046.” Croatian National Standard, 1984.
- [5] Damjanović, D.: Utjecaj temperature na dinamičke parametre građevinskih konstrukcija, Sveučilište u Zagrebu, Građevinski fakultet, 2010.
- [6] Le, T., Tamura, Y.: Modal Identification of ambient vibration structure using frequency domain decomposition and wavelet transform, Proceedings 7th Asia-Pacific Conf. Wind, no. 2001, 2009.
- [7] Marendić, A., Paar, R., Grgac, I., Damjanović, D.: Monitoring of oscillations and frequency analysis of the railway bridge ‘Sava’ using robotic total station, Proceedings of 3rd Joint International Symposium on Deformation Monitoring (JISDM), 2016.
- [8] Psimoulis, P., Stiros, S.: Measuring Deflections of a Short-Span Railway Bridge Using a Robotic Total Station, J. Bridg. Eng., vol. 18, pp. 182–185, 2013.
- [9] Computers and Structures Inc., “CSI Analysis Reference Manual.” p. 496, 2011.



## THE INTERACTION OF STEEL RAILWAY BRIDGES WITH WOODEN SLEEPERS AND LOADED CWR TRACKS IN RESPECT OF LONGITUDINAL FORCES

Helga Papp, Nándor Liegner

*Budapest University of Technology and Economics, Faculty of Civil Engineering,  
Department of Highway and Railway Engineering, Hungary*

### Abstract

If rails are constructed continuously over discontinuities (such as between a bridge deck and an abutment) without any rail expansion devices, the rails might restrain the free movement of the bridge, therefore longitudinal forces might be generated in the rails, in the bridge structure and the fixed bridge bearings. As a result of the interaction of steel railway bridges and continuously welded rail (CWR) tracks, normal force can be generated in the rails from the deflection of the bridge deck, from braking and acceleration of the trains and from change of temperature. Internal forces and displacements resulting from the change of temperature arise on an unloaded track. Effects from the braking and acceleration of the trains are generated on a loaded track. The longitudinal behaviour of a loaded and an unloaded track is basically different, therefore a non-linear computation has to be carried out on an unloaded and another one on a loaded track. Eurocode standard allows for the linear superimposing of results obtained from two non-linear models. This paper produces calculation methods for the combined response of CWR tracks and bridges in respect of longitudinal effects, without carrying out computations on two separate non-linear models. Recommendations are presented for the calculation of internal normal forces in the rails, bridge structure and the fixed bearing, and also that for relative displacement of the bridge and the rail.

*Keywords: expansion joint, heat expansion, steel bridge, wooden sleepers, rail restraint, combined response*

### 1 Introduction

A finite-element (FEM) model has been developed to determine the normal, axial forces in the rail, bridge structure and the bearing in case of a two-span-bridge with an expansion length of 40 m resulting from the change of temperature and braking and acceleration of trains. Following this, the model has been converted into bridges with 70 m and 100 m expansion.

### 2 Laboratory testing

Test series have been carried out in the Laboratory of the Department of Highway and Railway Engineering, Budapest University of Technology and Economics. The aim of these tests was to determine the longitudinal stiffness and the longitudinal rail restraint of Vossloh KS (Skl-12) fastening in case there was railpad under the railbase.

## 2.1 Longitudinal rail restraint tests without any vertical load

The tests were carried out according to standard EN 13146-1:2012 [1]. The test arrangement is shown in Figure 1. The rail displacement was measured with inductive transducer of type Hottinger Baldwin Messtechnik (HBM) WA20 mm and the load was measured with force transducer of type HBM C9B 50 kN. The data acquisition unit and measuring amplifier was HBM Quantum MX 840, evaluation software was Catman AP. The sampling rate frequency was 10 Hz. The load – displacement diagrams are illustrated in Figure 2 and the results are summarized in Table 1.



Figure 1 The test arrangement

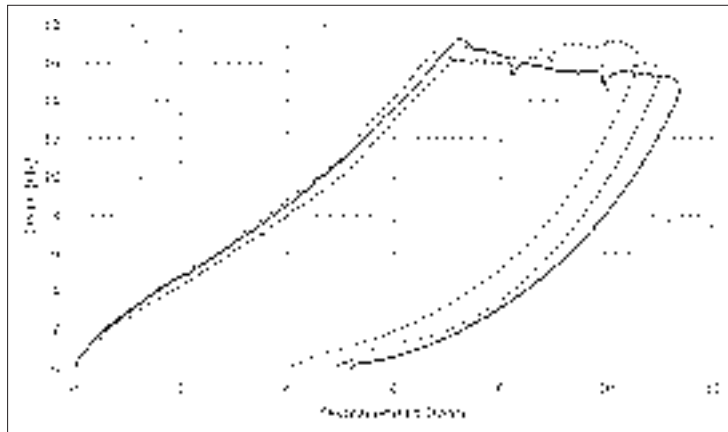


Figure 2 Force-displacement diagram of KS fastening

Table 1 Longitudinal rail restraint and stiffness of rail fastenings (without any vertical load)

Test	Longitudinal rail restraint [kN]	Longitudinal stiffness [kN/m]
1	15.81	2268
2	15.59	2279
3	15.65	2174
Average	15.68	2240

## 2.2 Longitudinal rail restraint tests with vertical load

The relationship between the longitudinal resistance of the loaded and unloaded track is indicated in Figure 3 according to EN 1991-2:2003 Standard. This standard specifies that the longitudinal resistance of the ballast is three times greater and that of the rail fastenings is twice higher than that in the unloaded condition.

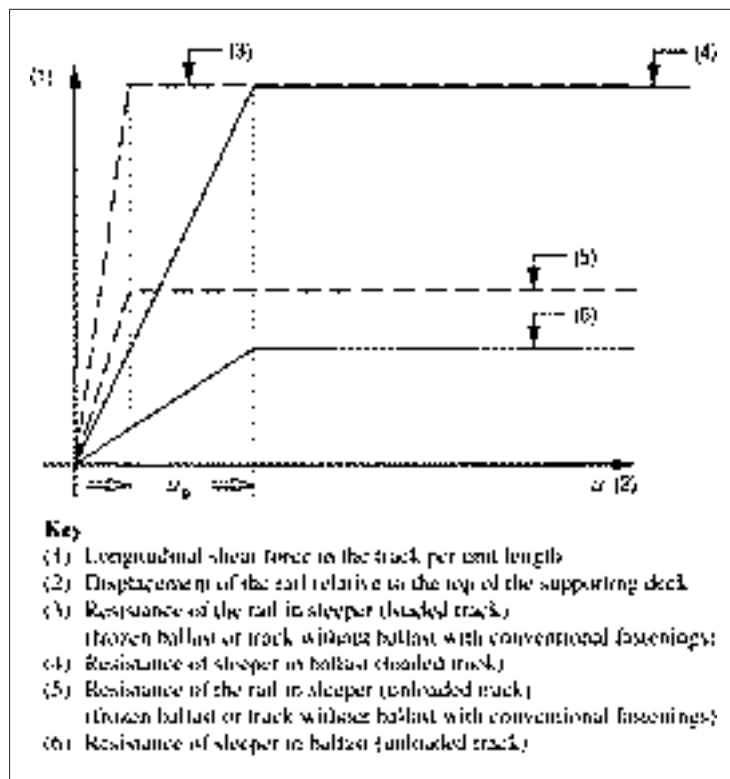


Figure 3 Variation of longitudinal shear force with longitudinal track displacement for one track [2]

The longitudinal rail restraint of the Vossloh Sk112 fastening has been determined as described in Chapter 2.1 in case of the unloaded track. Additional test series were carried out to determine the longitudinal rail restraint of fastenings loaded vertically in function of the vertical load. The tests were carried out in cases the fastening was loaded by 20 kN, 40 kN, 60 kN, 80 kN and 100 kN. The measurement results are illustrated in Figure 5.

In further calculations the longitudinal rail restraint has been taken into consideration that was obtained at a vertical load of 60 kN acting on the rail top. The results are indicated in Figure 6. The test results obtained at a vertical load of 60 kN are indicated in Figure 6, a longitudinal rail restraint of 34,11 kN and a longitudinal stiffness of 4500 kN/m have been obtained. The relationship between the loaded and the unloaded conditions is approximated well by the EN 1991-2:2003 Standard.





Figure 4 The test arrangement (with vertical load)

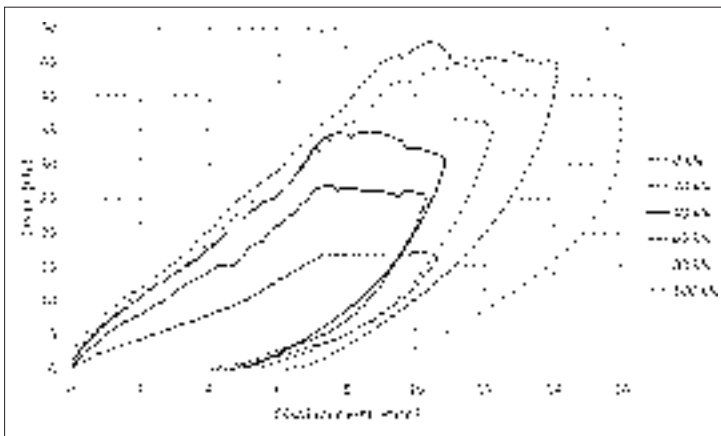


Figure 5 Force-displacement diagram of KS fastening with different vertical loads

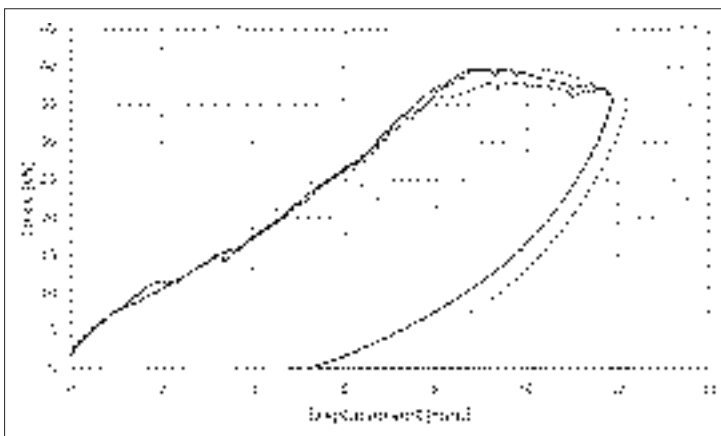


Figure 6 Force-displacement diagram of KS fastening with 60 kN vertical load

### 3 FEM models

The finite-element software of AxisVM 13 was used for models. The model structures consist of one rail of section 60E1 and half of the cross-sectional area of the bridge [3]. The static model of the bridge is illustrated in Figure 7. The fix support is located at the left hand-side and there are moving supports at mid-span and the right hand end.

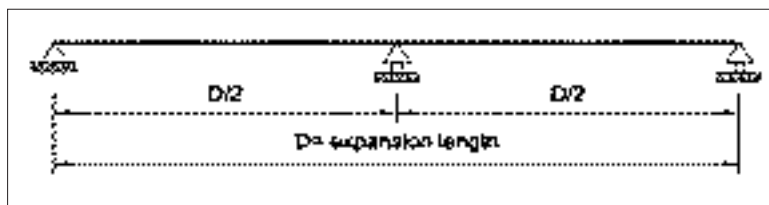


Figure 7 The static model of the railway bridges

It has been assumed in the models that a ballasted track with CWR joins the bridge at its both ends. The longitudinal resistance of newly laid ballast can be 5 N/mm on an unloaded track. The longitudinal ballast resistance of the track increases under the load of train. In case of loaded track the ballast longitudinal resistance is 18 N/mm in our calculations [2]. The properties of the springs between the CWR and the bridge – are defined on the basis of the laboratory tests. European Standard EN 1991-2 [2] require that the braking effect of the trains into the rails be substituted by a longitudinally uniformly distributed load of 20 kN/m per two rails that is 10 kN/m per one rail through a total length of 300 m. It has a maximum value of 6000 kN on the bridge. The acceleration of the trains is to be taken into consideration by an evenly distributed longitudinal load of 33 kN/m with a total value of 1000 kN. Of the two effect, it is the braking that produces higher force, therefore this is critical. In case of critical load combination the position of maximum values of normal forces generated by the change of temperature and by braking should coincide [4] [5] [6].

### 4 Determination of normal forces

First the maximum values of the normal forces in the bridge structure, the fixed bearing and the continuously welded rail track were determined in case the vertical load of the vehicle is neglected [4]. The results are summarized for tracks with wooden sleepers and Sk12 rail fastenings on bridges with expansion length of 40 m, 70 m and 100 m without any rail expansion joints, Table 2. The FEM models have been built also with the assumption of the track loaded vertically as well. Also bridges with expansion length of 40 m, 70 m and 100 m have been modelled. The results are summarized in Table 3.

Table 2 Maximum normal forces without any vertical load

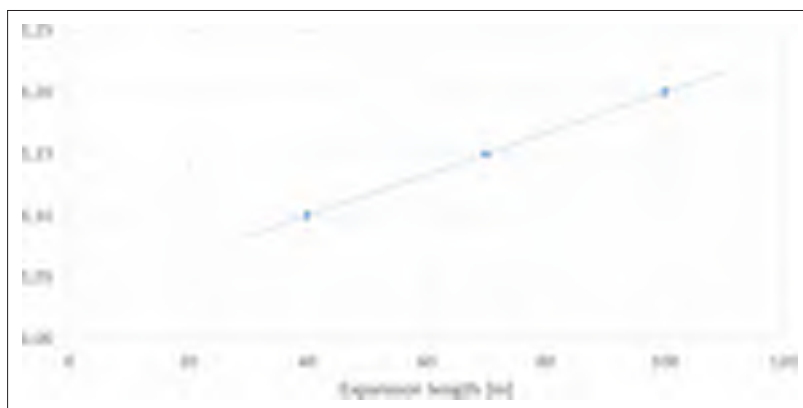
Expansion length [m]	Maximum normal force [kN]		
	Bridge structure	Fixed bearing	CWR track
40	±1051	±1051	-1701/+1947
70	±1666	±1666	-1731/+1977
100	±2054	±2054	-1855/+2102

**Table 3** Maximum normal forces with 60 kN vertical load

Expansion length [m]	Maximum normal force [kN]		
	Bridge structure	Fixed bearing	CWR track
40	±1162	±1120	-1433/+1680
70	±1927	±1893	-1751/+1998
100	±2466	±2428	-1973+/2219

## 5 Conclusions

It can be concluded from the results that the difference between the normal forces in the loaded track and the unloaded track increases with increasing expansion length. Greater internal forces are resulted on the loaded track. Omitting the vertical load of the vehicle is not an approximation in favour of safety. The proportion between the loaded and the unloaded conditions increases with expansion length, according to our computations the relationship is linear (Figure 8).



**Figure 8** Proportion between internal forces obtained on loaded and unloaded conditions in function of the expansion length of the bridge

## References

- [1] EN 13146-1:2012, European Standard, Railway applications, track, test methods for fastening systems, Part 1, Determination of longitudinal rail restraint, European Committee for Standardization, ICS 93.100, 2012.
- [2] MSZ EN 1991-2:2006, European Standard, Eurocode 1, Actions on bridges, Part 2, Traffic loads on bridges, European Committee for Standardization, ICS 91.010.30, 93.040, 2006.
- [3] Birk, C., Ruge, P.: Longitudinal track-structure interaction on railway bridges, *Proceedings in Applied Mathematics Mechanics*, Vol. 6, No. 1, 2006, pp. 209–210.
- [4] Liegner, N., Kormos, G., Papp, H.: Solutions of omitting rail expansion joints in case of steel railway bridges with wooden sleepers, *Periodica Polytechnica*, Vol. 59, No. 4, 2015, pp. 495–502.
- [5] Jiang, J.Z.: Additional longitudinal forces in continuously welded rails and their transmission on railway bridges, *China Railway Science*, Vol. 19, No. 2, 1998, pp. 67–75.
- [6] Yang, Y.B., Yau, J.D., Wu, Y.S.: *Vehicle–Rails–Bridge Interaction – Three-Dimensional Modeling. Vehicle–Bridge Interaction Dynamics: 2004*, pp. 311-407.

## AUTHOR INDEX

Aghazadeh Dokandari, Peyman.....	245	Čutura, Boris.....	869
Ahac, Maja.....	497	Čygas, Donatas.....	165, 659
Ahac, Saša.....	885, 893, 901	Ćirović, Goran.....	513
Aksentijevic, Jelena.....	39, 583	Damjanović, Domagoj.....	989
Albinović, Sanjin.....	149, 507	De Backer, Hans.....	909
Alduk, Waldemar.....	687	Deluka-Tibljaš, Aleksandra.....	45, 921
Andrijeauskas, Tadas.....	187	Deljanin, Abidin.....	141
Babanajad, Saeed.....	389	Deljanin, Emir.....	141
Bachmann, Dóra.....	567	Dimitrov, Emil.....	951
Bačić, Mario.....	293	Dimter, Sanja.....	237, 353, 667, 847
Badovinac, Darko.....	741	Djordjević, Dragan.....	131
Barić, Danijela.....	861	Dodev, Nikolay.....	951
Barišić, Ivana.....	527, 847	Dolaček-Alduk, Zlata.....	667
Barsi, Árpád.....	115	Domitrović, Josipa.....	237
Bartolac, Marko.....	791, 989	Dragčević, Vesna.....	885, 893
Basily, Basily.....	397	Duarte, Francisco.....	811
Bencze, Zsolt.....	267	Duvnjak, Branimir.....	557
Benz, Volker.....	823	Duvnjak, Ivan.....	989
Bezina, Šime.....	901	Džambas, Tamara.....	885, 893
Blazejowski, Krzysztof.....	217	Džebo, Suada.....	611
Bocz, Péter.....	335, 709	Džumhur, Saša.....	101
Bogdan, Mario.....	549, 573	Đurđević, Siniša.....	359
Bojovic, Nebojsa.....	447	Énekes, László.....	267
Borza, Viktor.....	437	Ferreira, Adelino.....	223, 803, 811
Brčić, Davor.....	373	Flinstch, Gerardo.....	803
Brezina, Tadej.....	379	Földiák, János.....	437
Bruns, André.....	619	Frey, Harald.....	67, 109
Buč, Sanjana.....	839	Fujiu, Makoto.....	365, 413, 597
Car, Marijan.....	301	Gandhi, A. R.....	471
Carrara, Sergio.....	769	Gáspár, László.....	181, 267
Cela, Liljana.....	877	Gavin, Kenneth.....	277, 285, 627
Chang, S.K. Jason.....	909	Ghasemi, Hamid.....	389
Christos, Antoniadis.....	817	Gjorgjievski, Mate.....	877
Cihlářová, Denisa.....	229	Glavinov, Aleksandar.....	695
Cimbola, Zdravko.....	667	Gradkowski, Krzysztof.....	521
Coiret, Alex.....	589	Gražulytė, Judita.....	643
Cuculić, Marijana.....	45	Gret, Goran.....	535
Cuervo-Tuero, Ana.....	589	Grgić, Viktorija.....	741
Cvek, Roman.....	527	Grzybowska, Wanda.....	195
Cvitanić, Dražen.....	855, 921		
Czerepak, Adam.....	549, 573		
Čovrk, Enes.....	101		

Gucunski, Nenad .....	389, 397	Lee, Hojin .....	703
Haladin, Ivo .....	791	Lee, Jin-Wook .....	309
Haramina, Hrvoje .....	39	Lee, JinWook .....	703
Hartmann, Timo .....	21	Lee, Sang Hyun .....	703
Hebib-Albinović, Mirna .....	507	Lee, Sung-Jin .....	309
Humić, Renato .....	557	Leth, Ulrich .....	67, 109
Hu, Zhiwei .....	715	Lewandowski, Mirosław .....	343
Icke, Philip .....	959	Librić, Lovorka .....	301
Igazvölgyi, Zsuzsanna .....	173	Liegner, Nándor .....	997
Ipavec, Aleksander .....	157	Lima de Paiva, Cassio .....	223
Ištoka Otković, Irena .....	59	Lim, Yujin .....	703
Ižvolt, Libor .....	733	Lopez Martinez, Alejandro .....	455
Jakhodiya, Devendra V. ....	471	Lovrić, Ivan .....	149, 869
Jan, Andrej .....	543	Lyons, Paul .....	959
Jefimowski, Włodzimierz .....	977	Machelski, Czesław .....	573
Jelenc, Marko .....	543, 935	Maciotek, Tadeusz .....	969
Jun, Seong-Chun .....	309	Macura, Dragana .....	123, 447
Jurić Kačunić, Danijela .....	301	Madejski, Janusz .....	651
Kanižaj, Krešimir .....	359	Maher, Ali .....	389, 397
Kapetanovic, Marko .....	447	Majstorović, Igor .....	73, 83, 91
Karleuša, Barbara .....	45	Maljković, Biljana .....	855
Kaya, Derya .....	245	Marenjak, Saša .....	687
Kee, Seong-Hoon .....	397	Marković, Ljubo .....	513
Kim, Bo-Kyong .....	309	Martinović, Karlo .....	277, 285
Kim, Jinyoung .....	397	Maslač, Danijela .....	149, 869
Kim, Sun-Il .....	309	Matzenberger, Petra .....	823
Kisgyörgy, Lajos .....	115	Mayerthaler, Anna .....	67, 109
Kiso, Fadila .....	141	McGregor, Gary .....	603
Klusáček, Ladislav .....	405	Mickovski, Slobodan B. ....	603
Koike, Kosuke .....	365	Mikić, Tatjana .....	131, 479
Kontrec, Damir .....	635	Miličević, Tomislav .....	479
Korlaet, Željko .....	209	Milić Marković, Ljiljana .....	513
Košćak, Janko .....	791, 989	Milosevic, Milutin .....	447
Kovačević, Meho Saša .....	293, 535, 627	Milošević, Milutin .....	123
Kozić, Mateo .....	45	Miltiadou, Marios .....	877
Krakutovski, Zoran .....	695	Minami, Takahiro .....	413
Kralj, Gregor .....	935	Miyake, Hiroyuki .....	597
Krason, Wieslaw .....	831, 943	Miyauchi, Kota .....	53
Kravcovas, Igoris .....	643	Mlinarić, Tomislav Josip .....	557
Krejčířřiková, Hana .....	405	Mollenhauer, Konrad .....	259
Kumrić, Oliver .....	489	Mondschein, Petr .....	229
Lađinović, Đorđe .....	203	Moser, Vladimir .....	847
Lakušić, Stjepan .....	497, 741, 791	Moslavac, Darko .....	695
Landmann, Jens .....	83, 91	Nakayama, Shoichiro .....	365, 413
Laurinavičius, Alfredas .....	659	Nedevska, Ivana .....	785
Lauwers, Dirk .....	909	Nenov, Nencho .....	951
Lechner, Bernhard .....	751	Niezgoda, Tadeusz .....	831, 943
		Nkayama, Shoichiro .....	597
		Obad, Ivan .....	497

Ognjenović, Slobodan.....	785	Stankiewicz, Michal.....	943
Olmeda Clemares, Ana.....	73	Starčević, Martin.....	861
Öner, Jülide.....	245	Steczek, Marcin.....	327
Orosz, Csaba.....	567	Stipanovic Oslakovic, Irina.....	627
Paiva, Cássio.....	811	Styliani, Sotiriadou.....	817
Pandžić, Hrvoje.....	549	Szeląg, Adam.....	327, 969
Papaioannou, P.....	817	Szele, András.....	115
Papp, Helga.....	997	Šarić, Ammar.....	149, 507
Park, Young-Kon.....	309	Šelmić, Milica.....	123
Parvardeh, Hooman.....	389	Šernas, Ovidijus.....	165
Pavāl, Flavius-Florin.....	929	Šešlija, Miloš.....	203
Pecak, Przemyslaw.....	217	Šimun, Miroslav.....	839
Pessoa de Oliveira, Lúcia.....	223	Šimunović, Domagoj.....	489
Pethő, László.....	173	Šlibar, Miha.....	157
Pilko, Hrvoje.....	379, 861	Šmalo, Michal.....	733
Piskulev, Petio.....	951	Šojat, Dino.....	373
Plášek, Otto.....	405	Šoštarić, Marko.....	373
Pranjić, Ivana.....	921	Špehar, Snježana.....	421, 757
Pretnar, Gregor.....	73, 83, 91	Šraml, Matjaž.....	59
Prutki-Pečnik, Gordana.....	527	Šurdonja, Sanja.....	45, 921
Puž, Goran.....	489	Švábenský, Otakar.....	405
Queiroz, Cesar.....	455	Takada, Kazuyuki.....	53
Radonjanin, Vlastimir.....	203	Takayama, Jun-ichi.....	365
Radović, Nebojša.....	203	Takayama, Jyunichi.....	413, 597
Rajčić, Davor.....	635	Teodorović, Dušan.....	123
Rajle, Damir.....	847	Tepeš, Krunoslav.....	379
Ramūnas, Vaidas.....	659	Thomas, Andree.....	83, 91
Ratkajec, Goran.....	527	Topal, Ali.....	245
Ravnikar Turk, Mojca.....	157	Tóth, Csaba.....	173
Ravnjak, Katarina.....	535	Trošt, David.....	91
Reale, Cormac.....	277, 285	Tušar, Marjan.....	157
Reiter, Uwe.....	73	Umair Shaukat, Muhammad.....	723
Rhodes, Steve.....	959	Vaitkus, Audrius.....	165, 187, 643, 659
Ristov, Riste.....	785	Vandanjon, Pierre-Olivier.....	589
Rüger, Bernhard.....	319, 823	Vendel, Jiří.....	405
Rukavina, Tatjana.....	237	Venturini, Loretta.....	769
Ruška, Filip.....	353	Vidak, Boris.....	463
Santos, João.....	803	Vinkó, Ákos.....	335, 709
Schöbel, Andreas.....	39, 431, 583	Vivoda, Bojan.....	293
Schönberger, Christine.....	583	Vorobjovas, Viktoras.....	187
Şengöz, Burak.....	245	Vranešić, Katarina.....	497
Shah, M. V.....	471	Wang, Hwachyi.....	909
Shala, Fitim.....	723	Wasilewska, Marta.....	217
Simić, Tatjana.....	479, 675	Wehr, Hans.....	431
Simnofske, Diana.....	259	Wieczorek, Maciej.....	343
Slavulj, Marko.....	359	Zafirovski, Zlatko.....	695
Soós, Zoltán.....	173		
Stančerić, Ivica.....	901		

Zagvozda, Martina.....	209, 353
Zhu, Jianyue.....	715
Zieliński, Piotr.....	195
Zobel, Robert.....	389

## ADVERTISEMENTS





Proceedings of the  
4<sup>th</sup> International Conference on Road and Rail Infrastructure – CETRA 2016  
23–25 May 2016, Šibenik, Croatia

TRAFFIC PLANNING AND MODELLING

CONSTRUCTION & MAINTENANCE

ROAD PAVEMENT

RAIL TRACK STRUCTURE

TRANSPORT GEOTECHNICS

NOISE & VIBRATION

TRACTION VEHICLES

INNOVATION & NEW TECHNOLOGY

URBAN TRANSPORT

TRAFFIC SAFETY

TUNNELS & BRIDGES

COMPUTER TECHNIQUES & SIMULATIONS

INTEGRATED TIMETABLES ON RAILWAYS

POWER SUPPLY OF TRANSPORT SYSTEMS

INFRASTRUCTURE PROJECTS

STRUCTURAL MONITORING

INFRASTRUCTURE MANAGEMENT