

Oblikovanje namještaja u zgradama za predškolski odgoj i obrazovanje kao temelj zdravoga dječjega rasta i razvoja

Iliev, Boris

Doctoral thesis / Disertacija

2021

Degree Grantor / Ustanova koja je dodijelila akademski / stručni stupanj: **University of Zagreb, Faculty of Forestry and Wood Technology / Sveučilište u Zagrebu, Fakultet šumarstva i drvne tehnologije**

Permanent link / Trajna poveznica: <https://urn.nsk.hr/urn:nbn:hr:108:425470>

Rights / Prava: [In copyright](#) / [Zaštićeno autorskim pravom.](#)

Download date / Datum preuzimanja: **2025-02-11**



Repository / Repozitorij:

[University of Zagreb Faculty of Forestry and Wood Technology](#)





UNIVERSITY OF ZAGREB
FACULTY OF FORESTRY AND WOOD TECHNOLOGY

BORIS ILIEV, M.Sc.

**Furniture design in facilities for preschool
education as a basis for healthy children's
growth and development**

DOCTORAL THESIS

Zagreb, 2021



UNIVERSITY OF ZAGREB
FACULTY OF FORESTRY AND WOOD TECHNOLOGY

BORIS ILIEV, M.Sc.

**Furniture design in facilities for preschool
education as a basis for healthy children's
growth and development**

DOCTORAL THESIS

Supervisor:

Danijela Domljan, Ph.D., Associate Professor

Zagreb, 2021



SVEUČILIŠTE U ZAGREBU
FAKULTET ŠUMARSTVA I DRVNE TEHNOLOGIJE

mr. sc. BORIS ILIEV

**Oblikovanje namještaja u zgradama za
predškolski odgoj i obrazovanje kao temelj
zdravoga dječjega rasta i razvoja**

DOKTORSKI RAD

Mentorica:

izv. prof. dr. sc. Danijela Domljan

Zagreb, 2021

Children, young or old, know good design when they see it. They are aware of quality.

Martin Dudek

Bibliographic data

UDK:

Title of doctoral dissertation: Furniture design in facilities for preschool education as a basis for healthy children's growth and development

The environment for the implementation of modern educational measures and methods in the current system of preschool education has changed in accordance with their development. This doctoral thesis seeks to answer the fundamental question whether the design of furniture and environments in education facilities (i.e. kindergartens) follows the development of new pedagogical methods and whether the existing furniture in kindergartens creates the foundation for healthy children's growth and development.

In order to answer this question and provide comparisons, the survey was conducted in three countries, namely the Republic of North Macedonia, the Republic of Croatia and the Republic of Bulgaria, i.e. in their capitals Skopje, Zagreb and Sofia. The polygons have been targeted in three different environments, where each has its own specific cultural characteristics as well as rules stipulating the implementation of educational methods, working conditions and different procedures linked to (public) procurement of furniture and equipment in kindergartens. These distinctive features allowed a comparative overview of similarities and differences between various conditions and systems, equipment and methodology of work in the context of a particular polygon. The paper analyses a historical review of the development of kindergarten furniture, preschool educational system in three observed states, European standards for furniture in preschool institutions, explains the role of anthropometry in kindergartens and psychological and pedagogical aspects affecting furniture and interiors in kindergartens and examines designers' responsibility in the design of furniture in kindergartens.

The subject of this research is the design of modern furniture used in preschool educational institutions. The basic objectives of the research comprise the following elements: O1: determining whether the furniture and equipment with which children currently come into contact in kindergartens on daily basis in three different countries accommodate healthy growth and development of children, especially from the point of view of design, functional dimensions prescribed in line with the applicable standards, the application of wood and other environmentally-friendly materials, safety and other criteria, and O2: defining the basic requirements for the design and furnishing of furniture in kindergartens that would involve professionals from several different scientific fields in the design process of children's furniture. In that context, two hypotheses are highlighted, namely H1: furniture used by children in kindergartens does not meet the requirements of modern pedagogy, design, quality, safety, ergonomics and sustainability, and H2: it is possible to define new modern requirements and criteria for the design and quality of products, thereby creating prerequisites for the preservation of children's health.

Summary: In order to make the research involving minor children possible and in accordance with the code of ethics, the approval of institutions and offices responsible for equipping kindergartens, principals of individual kindergartens and parents of children participating in the survey was obtained in all three countries.

The survey was conducted in the three capitals of three countries (L), Skopje, Zagreb and Sofia, with the participation of a total of N=27 kindergartens-polygons (P), i.e. Zagreb (N=12P), Skopje (N=8P) and Sofia (N=7P). The research were conducted with three main groups of respondents: preschool children (c), educators (e) and producers (p) at all three locations (L). The research methods included measuring the functional dimensions of furniture, chairs (Nc=25, P=27), tables (Nt=22, P=27), beds (Nb=8, P=27) and storage furniture (Ns=25, P=27), and measuring the anthropometric variables of children (Nc=848, P=15), a survey questionnaire designed for two types of respondents (Ne=593, P=39; Np=12, P=12), interviewing children using the Mosaic method (Nc=36, P=1), and observing and taking photographs of children and furniture (P=15). The anthropometric variables prescribed by manuals were used for the anthropometric measurements while the European Standard EN 1729- 1:2015, applied in all three countries, was used for comparison. The survey questionnaire for educators comprised a total of 74 questions, and the questionnaire for producers 53 questions divided into five sections. The Mosaic method was introduced as a completely new method in educational institutions. This method which puts the user (child) at the forefront and collects children's views on the problem under scrutiny. The Mosaic method was carried out in one kindergarten where 36 children were given a picture questionnaire and asked to draw their ideal kindergarten classroom. Statistical processing was carried out using MedCalc or IBM SPSS Statistics software tools.

The results obtained confirmed the hypotheses and indicate that functional dimensions of furniture and equipment do not correspond to the anthropometric dimensions of children, which does not contribute to maintaining a healthy and physically appropriate position of the body and that environmentally-friendly materials were not used. The results prove that the analysed design and construction of furniture used in kindergartens do not meet the new pedagogical and psychological standards recommended in the literature and recommendations taken from conversations with educators. Both the design and dimensions of furniture are not suited to creating various spatial setups in kindergarten classrooms where most of the educational process take place. Thus, the prerequisites for designing new solutions and suggesting new ways of equipping the observed facilities have been set.

The contribution of research results has been presented in the innovative concepts and design solutions of products that could be located in rooms used by different children age groups in

accordance with appropriate pedagogical guidelines and educational methods that create the foundation for healthy children's growth and development.

The thesis confirms that it is necessary to establish an intensive interdisciplinary cooperation between different professions on this issue in future research and design of furniture in preschool facilities. Only with an appropriate approach to children's healthy growth and development, we can create the foundations for the development of a healthy community and society as a whole.

Key words: Kindergarten furniture, kindergarten interior, preschool children, proper growth, interdisciplinarity
Scientific area: Biotechnological sciences
Scientific field: Wood technology, Construction and design of wood products
Institution: University of Zagreb Faculty of Forestry and Wood Technology, Department of Wood Technology, Institute of Furniture and Wood Products
Supervisor: Danijela Domljan, PhD, associate professor
Number of pages: 274
Number of figures: 73
Number of tables: 66
Number of charts: 20
Number of references: 206
Supplement: CD with selected data
Oral examination / date: 8. 7. 2021
Zoran Vlaović, Ph.D., associate professor, University of Zagreb Faculty of Forestry and Wood Technology, chairman
Dissertation committee: Danijela Domljan, Ph.D., University of Zagreb Faculty of Forestry and Wood Technology, supervisor, member
Tanja Jurčević, Lulić, Ph.D., full professor, member, University of Zagreb Mechanical Engineering and Naval Architecture
Institution / archived: University of Zagreb Faculty of Forestry and Wood Technology

Podaci za bibliografsku karticu

UDK:

Naslov doktorskog rada: Oblikovanje namještaja u zgradama za predškolski odgoj i obrazovanje kao temelj zdravoga dječjega rasta i razvoja

Sukladno razvoju suvremenih odgojno-obrazovnih mjera i metoda u današnjem sustavu predškolskog odgoja i obrazovanja mijenja se i okruženje u kojemu se one provode. Temeljno pitanje na koje su u doktorskome radu nastoji dati odgovor je prati li oblikovanje namještaja i okruženja u zgradama za odgoj i obrazovanje (kraće: vrtićima) nove pedagoške metode i stvara li postojeći namještaj u vrtićima temelje za zdravi dječji rast i razvoj.

Kako bi se odgovorilo na postavljeno pitanje i omogućila usporedba, istraživanje je provedeno u tri države: Republici Sjevernoj Makedoniji, Republici Hrvatskoj i Republici Bugarskoj, tj. njihovim glavnim gradovima Skoplju, Zagrebu i Sofiji. Poligoni su ciljano odabrani u tri različite sredine od kojih svaka ima svoje posebne kulturološke karakteristike kao i pravila provođenja odgojno-obrazovnih metoda, uvjete rada te različit postupak (javne) nabave namještaja i opreme u vrtićima. Upravo te posebnosti omogućile su komparativno utvrđivanje sličnosti i različitosti uvjeta i sustava, opremljenost i metodologiju rada unutar pojedinog poligona.

Rad analizira povijesni pregled razvoja vrtićkog namještaja, predškolski obrazovni sustav u tri promatrane države, europske norme za namještaj u predškolskim ustanovama, objašnjava ulogu antropometrije u vrtićima, psihološke i pedagoške aspekte koji utječu na namještaj i interijere u vrtićima te preispituje odgovornost dizajnera u oblikovanju namještaja u vrtićima.

Predmet istraživanja je oblikovanje suvremenog namještaja koji se koristi u predškolskim odgojnim ustanovama. Osnovni ciljevi rada odnose se na C1: utvrđivanje je li trenutni namještaj i oprema s kojim djeca svakodnevno dolaze u kontakt u vrtićima u tri različite zemlje primjeren zdravom rastu i razvoju djece, naročito sa stajališta oblikovanja, funkcionalnih dimenzija propisanih važećim normama, primjene drvenih i drugih ekoloških materijala, sigurnost i drugih kriterija; te C2: definiranje osnovnih zahtjeva na oblikovanje i opremanje vrtićkog namještaja čime bi se u postupak oblikovanja dječjeg namještaja uključili profesionalci iz nekoliko različitih znanstvenih područja. Istaknute su dvije hipoteze, H1: Namještaj kojeg djeca koriste u vrtićima ne odgovara zahtjevima suvremene pedagogije, dizajna, kvalitete, sigurnosti, ergonomije i održivosti; te H2: Moguće je definirati nove suvremene zahtjeve i kriterije za oblikovanje i kvalitetu proizvoda, a time stvoriti preduvjete za očuvanje dječjeg zdravlja.

Kako bi istraživanje s maloljetnom djecom bilo moguće i u skladu s etičkim kodeskom, dobiveno je odobrenje ustanova i ureda nadležnih u pojedinoj državi za provedbu opremanja promatranih vrtića, ravnatelja pojedinih vrtića te roditelja djece koja su sudjelovala u istraživanju.

Sažetak:

Istraživanje je provedeno u tri glavna grada triju država-lokacija (L): Skoplju, Zagrebu i Sofiji, u kojima je sudjelovalo sveukupno $N=27$ dječjih vrtića-poligona (P): Zagreb ($N=12P$), Skoplje ($N=8P$) i Sofija ($N=7P$). Istraživanja su provedena s tri glavne skupine ispitanika: predškolskom djecom (d), odgajateljima (o) i proizvođačima (p) na sve tri lokacije L. Metode istraživanja obuhvaćale su mjerenje funkcionalnih dimenzija namještaja pri čemu su mjerene stolice ($N_s=25$, $P=27$), stolovi ($N_S=22$, $P=27$), kreveti ($N_k=8$, $P=27$) i namještaj za odlaganje ($N_{np}=25$, $P=27$), te mjerenje antropometrijskih varijabli djece ($N_d=848$, $P=15$), zatim anketni upitnik s dvije vrste ispitanika ($N_o=593$, $P=39$; $N_p=12$, $P=12$), intervjuiranje djece Mozaik metodom ($N_d=36$, $P=1$), kao i promatranje i fotografiranje djece i namještaja ($P=15$). Za metodu antropometrijskih mjerenja korištene su antropometrijske varijable propisane priručnicima, dok je za usporedbu s normom korištena važeća norma EN 1729-1:2015 koja se primjenjuje u svim obuhvaćenim državama. Anketni upitnik za odgajatelje sadržavao je sveukupno 74 pitanja, a upitnik za proizvođače 53 pitanja podijeljenih u pet odjeljaka. Mozaik metoda predstavljala je sasvim novu metodu u obrazovnim ustanovama, koja u prvi plan stavlja korisnika (dijete) i prikuplja korisnikove stavove o promatranom problemu. Mozaik metoda provedena je u jednom vrtiću pri čemu je 36 djece dobilo slikovni upitnik i zadatak da nacrtaju svoju idealnu dnevnu sobu u vrtiću. Statistička obrada provedena je s MedCalc i s IBM SPSS Statistics programskim alatima.

Dobiveni rezultati potvrdili su postavljene hipoteze te ukazuju da ponuđeni namještaj i oprema funkcionalnim dimenzijama ne odgovaraju antropometrijskim dimenzijama djece, ne pomažu u održavanju zdravog i tjelesno odgovarajućeg položaja tijela te da ne koriste ekološke materijale. Rezultati dokazuju da analizirana oblikovno-konstruktivna rješenja namještaja u vrtićima ne zadovoljavaju nove pedagoške i psihološke standarde preporučene literaturom i savjete/preporuke iz razgovora s odgajateljima. Namještaj je i oblicima i dimenzijama neprilagođen stvaranju različitih prostornih organizacija u vrtićkim dnevnim boravcima gdje se većinom provodi odgojno obrazovni proces. Spomenuto stvara preduvjete oblikovanja novih rješenja i prijedloge načina opremanja promatranih zgrada.

Doprinos istraživačkih rezultata u radu je u prikazanim inovativnim konceptima i oblikovnim rješenjima proizvoda koji bi se mogli nalaziti u prostorijama različitih vrtićkih dobnih skupina djece, sukladno primjerenim pedagoškim smjernicama i odgojno i obrazovnim metodama koje stvaraju temelje za zdravi dječji rast i razvoj.

Rad potvrđuje nužnost intenzivne interdisciplinarnе suradnje različitih struka na ovoj problematici u budućim istraživanjima i oblikovanju namještaja u zgradama za predškolski odgoj i obrazovanje, gdje su glavni korisnici djeca. Prikladnim pristupom dječjem zdravom rastu i razvoju stvaramo temelje razvoja zdrave zajednice i društva u cjelini.

Ključne riječi: Namještaj za dječje vrtiće, interijer dječjih vrtića, predškolska djeca, pravilno odrastanje, interdisciplinarnost

Znanstveno područje: Biotehničko područje

Znanstveno polje, grana: Drvna tehnologija, Konstruiranje i oblikovanje proizvoda od drva

Institucija u kojoj je rad izrađen: Sveučilište u Zagrebu Fakultet šumarstva i drvne tehnologije, Drvnotehnološki odsjek, Zavod za namještaj i drvne proizvode

Mentor rada: Izv. prof. dr. sc. Danijela Domljan

Broj stranica: 274

Broj slika: 73

Broj tablica: 66

Broj grafikona: 20

Broj korištenih bibliografskih jedinica: 206

Prilog doktorskom radu: CD s podacima i radom u elektronskom obliku

Datum obrane: 8. 7. 2021.

Povjerenstvo: izv. prof. dr. sc. Zoran Vlaović, Sveučilište u Zagrebu, Fakultet šumarstva i drvne tehnologije predsjednik povjerenstva
izv. prof.dr.sc. Danijela Domljan, Sveučilište u Zagrebu, Fakultet šumarstva i drvne tehnologije mentor, članica
prof. dr. sc. Tanja Jurčević Lulić, Sveučilište u Zagrebu, Fakultet strojarstva i brodogradnje, članica

Institucija u kojoj je rad pohranjen: Sveučilište u Zagrebu, Fakultet šumarstva i drvne tehnologije

DEDICATION

To my father, mother and sister as well as to all those who unreservedly believed and supported me. (kg)

I dedicate it to all the children with the hope of at least a small contribution to a healthy development in the overall preschool environment.

Boris Iliev, M.Sc.

CONTENT

CONTENT	VIII
PREFACE	XII
ABSTRACT	XIV
SAŽETAK	XVI
АБСТРАКТ	XVIII
РЕЗЮМЕ	XXI
MENTORS BIOGRAPHY	XXIV
LIST OF ILLUSTRATIONS	XXV
TABLE OF FIGURES	XXV
TABLE OF TABLES	XXVI
TABLE OF CHARTS.....	XXVIII
1. INTRODUCTION	1
2. THEORETICAL BASIS AND ANALYSIS OF THE TOPIC	5
2.1. HISTORICAL OVERVIEW OF THE DEVELOPMENT OF KINDERGARTEN FURNITURE.....	6
2.2. PRESCHOOL EDUCATIONAL SYSTEMS IN THREE OBSERVED COUNTRIES	17
2.2.1. Republic of North Macedonia – organizational set-up of preschool system	17
2.2.2. Republic of Bulgaria – organizational set-up of preschool system	18
2.2.3. Republic of Croatia – organizational set-up of preschool system.....	19
2.2.4. Statistic data for preschool children	19
2.2.5. Duration of education process in the three observed countries	20
2.3. EUROPEAN STANDARD FOR FURNITURE IN PRESCHOOL INSTITUTIONS	20
2.4. THE ROLE OF ANTHROPOMETRY IN KINDERGARTENS.....	21
2.4.1. Factors impacting anthropometric data	23
2.4.2. Anthropometry of preschool children	23
2.4.3. Periodization of the development of the child.....	24
2.4.4. Physical growth and development of children.....	25
2.4.4.1. Characteristics of physical child's growth and development.....	25
2.4.4.2. Factors affecting children's anthropometric data	27
2.4.4.3. Secular trend in the process of growth and development of children.....	30
2.4.5 Importance of anthropometric data in the designing of preschool furniture.....	32
2.4.5.1. Inconsistency between children's body dimensions and educational furniture.....	35
2.5. PSYCHOLOGICAL AND PEDAGOGICAL ASPECTS AFFECTING FURNITURE AND INTERIORS IN KINDERGARTENS	36
2.5.1. Colors in kindergartens	44
2.6. RESPONSIBILITY OF DESIGNERS IN DESIGNING FURNITURE IN KINDERGARTENS	46

2.7. SUMMARY OF THE THEORETICAL FOUNDATIONS AND PREVIOUS RESEARCH	48
3. BASIC OBJECTIVES AND HYPOTHESIS OF THE RESEARCH.....	50
3.1. SUBJECT OF THE RESEARCH	50
3.2. RESEARCH OBJECTIVES.....	51
3.3. HYPOTHESES.....	51
4. RESEARCH METHODS, POLYGONS, SAMPLES AND PARTICIPANTS	52
4.1. PERMISSION FOR RESEARCH WITH PRESCHOOL CHILDREN.....	52
4.2. RESEARCH METHODS	52
4.2.1. <i>Measurement methods</i>	52
4.2.1.1. Measurement of the dimensions of the samples - preschool furniture.....	53
4.2.1.2. Anthropometric measurements of preschool children.....	54
4.2.2. <i>Survey methods</i>	59
4.2.2.1. Survey on kindergartens employees	59
4.2.2.2. Survey on manufacturers / distributors.....	60
4.2.3. <i>Mosaic method</i>	61
4.2.4. <i>Observation and photography of furniture and children</i>	61
4.2.5. <i>Statistical data processing method</i>	62
4.3. POLYGONS	62
4.3.1. <i>Polygons in the measurement method</i>	62
4.3.1.1. Polygons in the method of measurement of the samples-furniture.....	63
4.3.1.2. Polygons in anthropometric measurements.....	65
4.3.2. <i>Polygons in the survey method</i>	66
4.3.3. <i>Polygons in the Mosaic method</i>	67
4.3.4. <i>Polygons in the method of observation and photographing</i>	67
4.4. FURNITURE SAMPLES	67
4.4.1. <i>Chairs</i>	68
4.4.2. <i>Tables</i>	74
4.4.3. <i>Beds</i>	79
4.4.4. <i>Storage furniture</i>	82
4.5. PARTICIPANTS (RESPONDENTS).....	88
4.5.1. <i>Participants - children in anthropometric measurements</i>	89
4.5.2. <i>Participant in survey methods</i>	92
4.5.2.1. Kindergarten employees in survey method	92
4.5.2.2. Producers / distributors in survey method	93
4.5.3. <i>Participants - children in Mosaic method</i>	93
4.5.4. <i>Participants - children in the method of observation and photographing</i>	93
5. RESULTS.....	94
5.1. RESULTS OF THE MEASUREMENTS OF SAMPLES AND PARTICIPANTS.....	94
5.1.1. <i>Results from measuring furniture</i>	94

5.1.1.1. Results of chairs' measurements	94
5.1.1.2. Results of tables' measurements	97
5.1.1.3. Results of beds' measurements	100
5.1.1.4. Results of Storage furniture' measurements	101
5.1.2. <i>Results of children's anthropometric measurements</i>	103
5.4.1.1. Differences between genders	104
5.4.1.2. Differences between polygons in anthropometric parameters.....	108
5.1.3. <i>Comparison of furniture dimensions and standard</i>	114
5.1.4. <i>Comparison of furniture and anthropometric measurements of children</i>	117
5.2. RESULTS OF SURVEY QUESTIONNAIRES	118
5.2.1. <i>Results of kindergarten employees' survey</i>	118
5.2.2. <i>Results of furniture manufacturers' survey</i>	130
5.3. RESULTS OF THE MOSAIC METHOD WITH CHILDREN	135
5.4. RESULTS OF THE METHOD OF OBSERVING AND PHOTOGRAPHING FURNITURE AND CHILDREN.....	141
6. DISCUSSION	145
6.1. DISCUSSION ON CHAIR'S DESIGN	145
6.1.1. <i>Comparison of popliteal height with height of seat</i>	157
6.2. DISCUSSION ON TABLE'S DESIGN	159
6.3. DISCUSSION ON BED'S DESIGN	162
6.4. DISCUSSION ON STORAGE FURNITURE.....	164
6.5. ATTITUDES OF EDUCATORS IN RELATION TO THE FURNITURE THEY USE IN KINDERGARTENS.....	167
6.6. EDUCATORS' VIEWS ON THE APPLIED COLORS	169
6.7. SPATIAL ORGANISATION IN THE PREMISES OF THE KINDERGARTENS.....	171
6.7.1. <i>Behavioral and educational activities regarding kindergarten's environment</i>	177
6.7.2. <i>Other parameters affecting the modification of the space – playroom</i>	178
6.8. DISCUSSION REGARDING OF MANUFACTURER'S SURVEY RESULTS	184
6.9. DISCUSSION ON CHILDREN DRAWINGS AS A PART OF MOSAIC METHOD	186
6.10. DISCUSSION ON THE ANALYZED RESULTS.....	188
6.11. NEW APPROACH FOR DEVELOPMENT OF THE FURNITURE FOR KINDERGARTENS	190
6.12. PROPOSAL OF A NEW PURCHASING METHODS/PLAN.....	192
6.13. NEW IDEAS AND VISIONS.....	193
7. CONCLUSION	201
8. BIBLIOGRAPHY.....	205
APPENDIX.....	214
APPENDIX I. FORM FOR ANTHROPOMETRIC DIMENSIONS OF THE RESPONDENTS - CHILDREN.....	214
APPENDIX II. SURVEY FOR RESPONDENTS - EMPLOYEES IN KINDERGARTENS	215
APPENDIX III. SURVEY RESULTS OF THE RESPONDENTS /EDUCATORS - SUGGESTIONS AND COMMENTS	222
APPENDIX IV. SURVEY ON RESPONDENTS - MANUFACTURERS / SUPPLIERS OF PRESCHOOL FURNITURE	225

Appendix V. SURVEY ON RESPONDENTS / CHILDREN - MOSAIC METHOD	230
APPENDIX VI. PERMITS FOR CONDUCTING RESEARCH WITH CHILDREN	232
APPENDIX VII. RESULTS OF COMPARING FURNITURE WITH JUS AND BDS STANDARDS	235
Comparison of the measured furniture with the standard BDS (БДС) 8475 – 88.....	238
Comparison of the furniture with normative acts for a preschool educational process	239
CURRICULUM VITAE	241
ŽIVOTOPIŠ	242
LIST OF PUBLISHED PAPERS	243

PREFACE

I sincerely want to thank all those who participated in the creation of this work.

I would like to express special thanks to prof. Dr. Konstantin Bahcevandziev from the Faculty of Design and Technologies of Furniture and Interior in Skopje, for the many moments in which he devoted his time for conversations, discussions, advice, and support since the moment I decided to enroll in the doctoral studies. I would also like to thank the Assistant Professor Yanko Genchev from the University of Forestry in Sofia, for the unconditional help and advice without which I would not have been able to do the research in Sofia. It is impossible not to mention Ms. Bosiljka Devernay, a Head of the Department for preschool education City Office of Education in Zagreb, and prof. Dubravka Vuletić an Advisor for preschool education City Office of Education in Zagreb for the understanding and support and the help in accessing the kindergartens in Zagreb and conducting the research smoothly. I would also like to express my gratitude to the principals of the kindergartens in Zagreb, Sofia and Skopje who provided me entering the preschool facilities, as well as to all the employees in the kindergartens who selflessly gave me advice, suggestions and remarks, which contributed to a more comprehensive and better formation of this academic writing.

I would also like to express my great gratitude to the employees of the administration of the City of Sofia, responsible for the preschool institutions, who provided me with access to the kindergartens, and most of all to Ms. Vesela Politova from the East Region, Municipality of Sofia.

I am also grateful to the principals and employees of the kindergartens in Skopje for their contribution to the creation of this writing, for their time and patience, and a number of other employees in the preschool institutions that are not mentioned here, but deserve attention.

I can not leave unmentioned the contribution of all the furniture manufacturers that participated in the research.

Many thanks to Krešimir Šolić, Ph.D., assistant professor, for the help with the statistical analysis and results, to Dragana Gjoreska MA, an English translator for translating the text, to Sanja Simoska, an academic artist, for the graphic beautification of my ideas and results shown in the doctoral thesis, as well as the colleague Elizabeta Slavkovska for the time and assistance in exchanging experiences, as well as many other colleagues who were in any way involved in the creation of this paper.

Special attention should be paid to all the children who participated in the research, with special gratitude for their patience while taking all the measurements (with the hope that this is

an attempt to make a small contribution to healthy development in their overall preschool environment).

I would also like to express my sincere and enormous gratitude to my (real) non-teachers and leaders throughout my doctoral studies and throughout the project, the professors who have greatly influenced me. Many thanks for their time, patience and advice they have given me when I needed them the most. Without their encouragement and selfless support, I probably would not have learned how to cope and persevere in scientific challenges. I would also like to thank Zoran Vlaović, Ph.D., associate professor and Tanja Jurčević-Lulić, Ph.D., full professor for helping me to defend and finish this thesis successfully

I especially and immensely thank my mentor, Danijela Domljan, Ph.D., associate professor, for her wholehearted assistance in all the phases of my doctoral studies, from the moment of enrolling in the doctoral studies, monitoring my development, choosing the topic and preparing the doctoral dissertation (without whose help this thesis would not have existed), as well as for the full support given professionally and personally, of the freedom of action, as well as of building self-confidence that I will bring all this to an end. It was a special pleasure and privilege to cooperate with her, as a great professional, with outstanding personal qualities.

Finally, I thank my family, my father, mother and sister as well as all those who unreservedly believed in me and gave me strength and support.

Thank you!

Sincerely,

Boris Iliev

ABSTRACT

The environment for the implementation of modern educational measures and methods in the current system of preschool education has changed in accordance with their development. This doctoral thesis seeks to answer the fundamental question whether the design of furniture and environments in education facilities (i.e. kindergartens) follows the development of new pedagogical methods and whether the existing furniture in kindergartens creates the foundation for healthy children's growth and development.

In order to answer this question and provide comparisons, the survey was conducted in three countries, namely the Republic of North Macedonia, the Republic of Croatia and the Republic of Bulgaria, i.e. in their capitals Skopje, Zagreb and Sofia. The polygons have been targeted in three different environments, where each has its own specific cultural characteristics as well as rules stipulating the implementation of educational methods, working conditions and different procedures linked to (public) procurement of furniture and equipment in kindergartens. These distinctive features allowed a comparative overview of similarities and differences between various conditions and systems, equipment and methodology of work in the context of a particular polygon.

The paper analyses a historical review of the development of kindergarten furniture, preschool educational system in three observed states, European standards for furniture in preschool institutions, explains the role of anthropometry in kindergartens and psychological and pedagogical aspects affecting furniture and interiors in kindergartens and examines designers' responsibility in the design of furniture in kindergartens.

The subject of this research is the design of modern furniture used in preschool educational institutions. The basic objectives of the research comprise the following elements: O1: determining whether the furniture and equipment with which children currently come into contact in kindergartens on daily basis in three different countries accommodate healthy growth and development of children, especially from the point of view of design, functional dimensions prescribed in line with the applicable standards, the application of wood and other environmentally-friendly materials, safety and other criteria, and O2: defining the basic requirements for the design and furnishing of furniture in kindergartens that would involve professionals from several different scientific fields in the design process of children's furniture. In that context, two hypotheses are highlighted, namely H1: furniture used by children in

kindergartens does not meet the requirements of modern pedagogy, design, quality, safety, ergonomics and sustainability, and H2: it is possible to define new modern requirements and criteria for the design and quality of products, thereby creating prerequisites for the preservation of children's health.

In order to make the research involving minor children possible and in accordance with the code of ethics, the approval of institutions and offices responsible for equipping kindergartens, principals of individual kindergartens and parents of children participating in the survey was obtained in all three countries.

The survey was conducted in the three capitals of three countries (L), Skopje, Zagreb and Sofia, with the participation of a total of N=27 kindergartens-polygons (P), i.e. Zagreb (N=12P), Skopje (N=8P) and Sofia (N=7P). The research were conducted with three main groups of respondents: preschool children (c), educators (e) and producers (p) at all three locations (L). The research methods included measuring the functional dimensions of furniture, chairs (Nc=25, P=27), tables (Nt=22, P=27), beds (Nb=8, P=27) and storage furniture (Ns=25, P=27), and measuring the anthropometric variables of children (Nc=848, P=15), a survey questionnaire designed for two types of respondents (Ne=593, P=39; Np=12, P=12), interviewing children using the Mosaic method (Nc=36, P=1), and observing and taking photographs of children and furniture (P=15). The anthropometric variables prescribed by current manuals were used for the anthropometric measurements while the European Standard EN 1729- 1:2015, applied in all three countries, was used for comparison. The survey questionnaire for educators comprised a total of 74 questions, and the questionnaire for producers 53 questions divided into five sections. The Mosaic method was introduced as a completely new method in educational institutions. This method which puts the user (child) at the forefront and collects children's views on the problem under scrutiny. The Mosaic method was carried out in one kindergarten where 36 children were given a picture questionnaire and asked to draw their ideal kindergarten classroom. Statistical processing was carried out using MedCalc or IBM SPSS Statistics software tools.

The results obtained confirmed the hypotheses and indicate that functional dimensions of furniture and equipment do not correspond to the anthropometric dimensions of children, which does not contribute to maintaining a healthy and physically appropriate position of the body and that environmentally-friendly materials were not used. The results prove that the analysed design and construction of furniture used in kindergartens do not meet the new pedagogical and psychological standards recommended in the literature and recommendations

taken from conversations with educators. Both the design and dimensions of furniture are not suited to creating various spatial setups in kindergarten classrooms where most of the educational process take place. Thus, the prerequisites for designing new solutions and suggesting new ways of equipping the observed facilities have been set.

The contribution of research results has been presented in the innovative concepts and design solutions of products that could be located in rooms used by different children age groups in accordance with appropriate pedagogical guidelines and educational methods that create the foundation for healthy children's growth and development.

The thesis confirms that it is necessary to establish an intensive interdisciplinary cooperation between different professions on this issue in future research and design of furniture in preschool facilities. Only with an appropriate approach to children's healthy growth and development, we can create the foundations for the development of a healthy community and society as a whole.

SAŽETAK

Sukladno razvoju suvremenih odgojno-obrazovnih mjera i metoda u današnjem sustavu predškolskog odgoja i obrazovanja mijenja se i okruženje u kojemu se one provode. Temeljno pitanje na koje su u doktorskom radu nastoji dati odgovor je prati li oblikovanje namještaja i okruženja u zgradama za odgoj i obrazovanje (kraće: vrtićima) nove pedagoške metode i stvara li postojeći namještaj u vrtićima temelje za zdravi dječji rast i razvoj.

Kako bi se odgovorilo na postavljeno pitanje i omogućila usporedba, istraživanje je provedeno u tri države: Republici Sjevernoj Makedoniji, Republici Hrvatskoj i Republici Bugarskoj, tj. njihovim glavnim gradovima Skoplju, Zagrebu i Sofiji. Poligoni su ciljano odabrani u tri različite sredine od kojih svaka ima svoje posebne kulturološke karakteristike kao i pravila provođenja odgojno-obrazovnih metoda, uvjete rada te različit postupak (javne) nabave namještaja i opreme u vrtićima. Upravo te posebnosti omogućile su komparativno utvrđivanje sličnosti i različitosti uvjeta i sustava, opremljenost i metodologiju rada unutar pojedinog poligona.

Rad analizira povijesni pregled razvoja vrtićkog namještaja, predškolski obrazovni sustav u tri promatrane države, europske norme za namještaj u predškolskim ustanovama, objašnjava ulogu antropometrije u vrtićima, psihološke i pedagoške aspekte koji utječu na

namještaj i interijere u vrtićima te preispituje odgovornost dizajnera u oblikovanju namještaja u vrtićima.

Predmet istraživanja je oblikovanje suvremenog namještaja koji se koristi u predškolskim odgojnim ustanovama. Osnovni ciljevi rada odnose se na C1: utvrđivanje je li trenutni namještaj i oprema s kojim djeca svakodnevno dolaze u kontakt u vrtićima u tri različite zemlje primjeren zdravom rastu i razvoju djece, naročito sa stajališta oblikovanja, funkcionalnih dimenzija propisanih važećim normama, primjene drvenih i drugih ekoloških materijala, sigurnost i drugih kriterija; te C2: definiranje osnovnih zahtjeva na oblikovanje i opremanje vrtićkog namještaja čime bi se u postupak oblikovanja dječjeg namještaja uključili profesionalci iz nekoliko različitih znanstvenih područja. Istaknute su dvije hipoteze, H1: Namještaj kojeg djeca koriste u vrtićima ne odgovara zahtjevima suvremene pedagogije, dizajna, kvalitete, sigurnosti, ergonomije i održivosti; te H2: Moguće je definirati nove suvremene zahtjeve i kriterije za oblikovanje i kvalitetu proizvoda, a time stvoriti preduvjete za očuvanje dječjeg zdravlja.

Kako bi istraživanje s maloljetnom djecom bilo moguće i u skladu s etičkim kodeskom, dobiveno je odobrenje ustanova i ureda nadležnih u pojedinoj državi za provedbu opremanja promatranih vrtića, ravnatelja pojedinih vrtića te roditelja djece koja su sudjelovala u istraživanju.

Istraživanje je provedeno u tri glavna grada triju država-lokacija (L): Skoplju, Zagrebu i Sofiji, u kojima je sudjelovalo sveukupno $N=27$ dječjih vrtića-poligona (P): Zagreb ($N=12P$), Skoplje ($N=8P$) i Sofija ($N=7P$). Istraživanja su provedena s tri glavne skupine ispitanika: predškolskom djecom (d), odgajateljima (o) i proizvođačima (p) na sve tri lokacije L. Metode istraživanja obuhvaćale su mjerenje funkcionalnih dimenzija namještaja pri čemu su mjerene stolice ($N_s=25$, $P=27$), stolovi ($N_S=22$, $P=27$), kreveti ($N_k=8$, $P=27$) i namještaj za odlaganje ($N_{np}=25$, $P=27$), te mjerenje antropometrijskih varijabli djece ($N_d=848$, $P=15$), zatim anketni upitnik s dvije vrste ispitanika ($N_o=593$, $P=39$; $N_p=12$, $P=12$), intervjuiranje djece Mozaik metodom ($N_d=36$, $P=1$), kao i promatranje i fotografiranje djece i namještaja ($P=15$). Za metodu antropometrijskih mjerenja korištene su antropometrijske varijable propisane priručnicima, dok je za usporedbu s normom korištena važeća norma EN 1729-1:2015 koja se primjenjuje u svim obuhvaćenim državama. Anketni upitnik za odgajatelje sadržavao je sveukupno 74 pitanja, a upitnik za proizvođače 53 pitanja podijeljenih u pet odjeljaka. Mozaik metoda predstavljala je sasvim novu metodu u obrazovnim ustanovama, koja u prvi plan stavlja korisnika (dijete) i prikuplja korisnikove stavove o promatranom problemu. Mozaik metoda

provedena je u jednom vrtiću pri čemu je 36 djece dobilo slikovni upitnik i zadatak da nacrtaju svoju idealnu dnevnu sobu u vrtiću. Statistička obrada provedena je s MedCalc i s IBM SPSS Statistics programskim alatima.

Dobiveni rezultati potvrdili su postavljene hipoteze te ukazuju da ponuđeni namještaj i oprema funkcionalnim dimenzijama ne odgovaraju antropometrijskim dimenzijama djece, ne pomažu u održavanju zdravog i tjelesno odgovarajućeg položaja tijela te da ne koriste ekološke materijale. Rezultati dokazuju da analizirana oblikovno-konstruktivna rješenja namještaja u vrtićima ne zadovoljavaju nove pedagoške i psihološke standarde preporučene literaturom i savjete/preporuke iz razgovora s odgajateljima. Namještaj je i oblicima i dimenzijama neprilagođen stvaranju različitih prostornih organizacija u vrtićkim dnevnim boravcima gdje se većinom provodi odgojno obrazovni proces. Spomenuto stvara preduvjete oblikovanja novih rješenja i prijedloge načina opremanja promatranih zgrada.

Doprinos istraživačkih rezultata u radu je u prikazanim inovativnim konceptima i oblikovnim rješenjima proizvoda koji bi se mogli nalaziti u prostorijama različitih vrtićkih dobnih skupina djece, sukladno primjerenim pedagoškim smjernicama i odgojno i obrazovnim metodama koje stvaraju temelje za zdravi dječji rast i razvoj.

Rad potvrđuje nužnost intenzivne interdisciplinarnе suradnje različitih struka na ovoj problematici u budućim istraživanjima i oblikovanju namještaja u zgradama za predškolski odgoj i obrazovanje, gdje su glavni korisnici djeca. Prikladnim pristupom dječjem zdravom rastu i razvoju stvaramo temelje razvoja zdrave zajednice i društva u cjelini.

АБСТРАКТ

Во согласност со развојот на современите воспитни мерки и методи во денешниот систем на предучилишно образование, се менува и опкружувањето во кое се спроведуваат. Основното прашање на кое докторската дисертација се обидува да одговори е дали дизајнот на мебел и околината во зградите за едукација (накратко: градинки) ги следи нови педагошки методи и дали постојниот мебел во градинките создава темели за здрав раст и развој на детето.

Со цел да се одговори на прашањето и да се овозможи споредба, истражувањето беше спроведено во три земји: Република Северна Македонија, Република Хрватска и Република Бугарија, односно нивните главни градови Скопје, Загреб и Софија. Полигоните беа намерно избрани во три различни средини, од кои секоја има свои

посебни културни карактеристики, како и правила за спроведување на едукативните методи, број на испитаници, услови за работа и различните постапки (јавни) набавки на мебел и опрема во градинките. Токму овие особености овозможува компаративно утврдување на сличностите и разликите на условите и системите, опремата и методологијата на работа во рамките на индивидуалниот многуаголник.

Трудот го анализира историскиот преглед на развојот на мебелот во градинките, системот на предучилишно образование во трите набљудувани земји, европските стандарди за мебел во предучилишните установи, ја објаснува улогата на антропометријата во градинките, психолошките и педагошките аспекти што влијаат на мебелот и ентериерот во градинките и ја испитува одговорноста на дизајнерите при дизајнот на мебел и обликување на просторот во градинките.

Предмет на истражување е дизајн на модерен мебел што се користи во предучилишните образовни институции. Главните цели на трудот се однесуваат на Ц1: утврдување дали сегашниот мебел и опрема со кои децата доаѓаат во секојдневен контакт во градинките во три различни земји е погоден за здрав раст и развој на децата, особено од аспект на дизајнот, функционалната димензии пропишани со важечките стандарди, еколошките материјали, безбедност и други критериуми; и Ц2: дефинирање на основните барања за дизајнирање и опрема на мебел во детските градинки, што би вклучило професионалци од повеќе различни научни области во процесот на дизајнирање на детски мебел. Истакнати се две хипотези, H1: Мебелот што го користат децата во градинките не ги исполнува барањата на модерната педагогија, во поглед на дизајн, квалитет, безбедност, ергономија и одржливост; и H2: Можно е да се дефинираат нови современи барања и критериуми за дизајн и квалитет на производот, а со тоа да се создадат предуслови за зачувување на здравјето на децата.

Со цел истражувањето со малолетни деца да биде овозможено и во согласност со етичкиот кодекс, одобрување од институциите и канцелариите одговорни во секоја земја за спроведување на истражувањето е добиено дозвола од страна на директорите на одделни градинки и родителите на децата кои учествувале во истражување.

Истражувањето е спроведено во три главни град во три републики-локации (L): Скопје, Загреб и Софија, во кои учествувале вкупно N=27 градинки-полигони (P): Загреб (N=12P), Скопје (N=8P) и Софија (N=7P). Истражувањето е спроведено со три главни групи испитаници: деца од предучилишна возраст (d), воспитувачи (v) и производители (p) во сите три локации. Методите на истражување вклучуваат мерење на

функционалните димензии на мебелот каде се мерат столовите ($N_s=25$, $P=27$), маси ($N_m=22$, $P=27$), кревети ($N_k=8$, $P=27$) корпусен мебел ($N_{km}=25$, $P=27$) мерење на антропометриски варијабли на деца ($N_d=848$, $P=15$), потоа анкети со два типа на испитаници ($N_v=593$, $P=39$; $N_p=12$, $P=12$), интервјуирање на деца со Мозаик методата ($N_d=36$, $P=1$), како и набудување и фотографирање на деца и мебел ($P=15$). За методот на антропометриски мерења, користени се антропометриски варијабли пропишани со важечки прирачници, додека за споредба со стандардот е користен валидниот стандард EN 1729-1: 2015, кој се применува во сите опфатени земји. Анкетниот прашалник за воспитувачи содржеше вкупно 74 прашања, а прашалникот за производителите 53 прашања поделени во пет делови. Мозаик методата беше целосно нов метод во образовните институции, кој го става корисникот (детето) во преден план и ги собира ставовите на корисникот за набудуваниот проблем. Методот со мозаик беше спроведен во една градинка каде на 36 деца им беше даден прашалник со слики и една задача да ја нацртаат својата идеална соба во градинката. Статистичката обработка беше извршена со софтверски алатки MedCalc или IBM SPSS Statistics.

Добиените резултати ги потврдија поставените хипотези и укажуваат на тоа дека постоечкиот мебел и опрема не одговараат на функционалните димензии на детските антропометриски димензии, не помагаат во одржување на здрава и физички соодветна положба на телото и не се користат еколошки материјали. Резултатите докажуваат дека анализираните обликовно-конструктивни решенија на мебелот не ги исполнуваат новите педагошки и психолошки стандарди препорачани од литературата и совети / препораки од разговори со воспитувачи. Дизајнот и димензиите на мебелот не се прилагодени за создавање на различни просторни организации во занималните во градинките, каде што се спроведува воспитно-образовниот процес. Ова создава предуслови за дизајнирање на нови решенија и предлози за тоа како да се опремаат предучилишните згради.

Придонесот на резултатите од истражувањето во трудот е во презентираниите иновативни концепти и решенија за дизајн на производи што би можеле да се употребат во занималните каде престојуваат различни возрасни групи деца во градинка, во согласност со соодветните педагошки упатства и едукативни методи кои создаваат темели за здрав дете раст и развој.

Трудот ја потврдува неопходноста од интензивна интердисциплинарна соработка на различни професии по ова прашање во идните истражувања и дизајнирање на мебел во згради за предучилишно образование, каде главни корисници се децата. Со соодветен

пристап кон здрав раст и развој на децата, создаваме основи за развој на здрава заедница и општеството како целина.

РЕЗЮМЕ

Средата за прилагане на съвременни образователни мерки и методи в сегашната система на предучилищното образование се променя в съответствие с тяхното развитие. Тази докторска дисертация се стреми да отговори на основния въпрос дали дизайнът на мебели и средата в учебните заведения (т.е. детските градини) следва развитието на нови педагогически методи и дали съществуващите мебели в детските градини създават основата за здрав растеж и развитие на децата.

Провежда се проучване в три държави, за да се отговори на този въпрос и за да се направят сравнения, а именно Република Северна Македония, Република Хърватия и Република България, т.е. в техните столици - Скопие, Загреб и София. Сферите на проучване са насочени в три различни среди, като всяка има свои определени културни характеристики, както и правила, предвиждащи прилагането на образователни методи, брой на субектите на проучването, условия на труд и различни процедури, свързани с (обществени) поръчки и доставки на мебели и оборудване в детските градини. Тези отличителни черти позволяват сравнителен преглед на приликите и разликите между различните условия и системи, оборудването и методологията на работа в контекста на определена сфера на изпитване.

Дисертацията включва анализ на историческия преглед в развитието на мебелите в детските градини, предучилищната образователна система в трите наблюдавани държави, Европейските стандарти за мебели в предучилищните институции, обясняват ролята на антропометрията в детските градини и психолого-педагогическите аспекти, касаещи мебелите и интериора в детските градини, и изследват отговорността на дизайнерите при проектирането на мебели за детските градини.

Субект на това изследване е проектирането на съвременни мебели, използвани в предучилищните образователни институции. Основните цели на изследването включват следните елементи: Ц1: определяне дали мебелите и оборудването, с които децата ежедневно влизат в контакт в детските градини в трите различни държави, дават възможност за здравословен растеж и развитие на децата, особено от гледна точка на дизайна, функционалните размери, в съответствие с приложимите стандарти, използване

на дърво и други екологични материали, безопасност, и други критерии и Ц2: определяне на основните изисквания за проектиране и обзавеждане на мебели за детските градини, които да включват специалисти от няколко различни научни области в процеса на проектиране на детските мебели. В този контекст се подчертават две хипотези, а именно Х1: мебелите, използвани от деца в детските градини, не отговарят на изискванията на съвременната педагогика, дизайн, качество, безопасност, ергономичност и устойчивост и Х2: възможно е да се определят нови съвременни изисквания и критерии за дизайна и качеството на продуктите, като по този начин се създават предпоставки за опазването на детското здраве.

За да бъде възможно изследването с участието на непълнолетни деца и в съответствие с етичния кодекс, беше получено одобрение и в трите държави от институциите и службите, отговарящи за детски градини, директорите на отделните детски градини и родителите на деца, участващи в изследването.

Изследването е проведено в трите столици на три държави (L), Скопие, Загреб и София, с участието на общо N=27 детски градини-сфери за обследване (P), т.е. Загреб (N=12P), Скопие (N=8P) и София (N=7P). Изследването е проведено с три основни групи респонденти: деца в предучилищна възраст (д), възпитатели (в) и производители (п) и на трите места (L). Методите за изследване включват измерване на функционалните размери на мебели, столове (N_c=25, P=27), маси (N_m=22, P=27), легла (N_л=8, P=27) и мебели за съхранение (N_{мс}=25, P=27) и измерване на антропометричните променливи на децата (N_д=848, P=15), анкетна анкета, предназначена за два вида респонденти (N_в=593, P=39; N_п=12, P=12), интервюиране на децата по метода Mosaic (N_д=36, P=1) и наблюдение и заснемане на децата и мебелите (P=15). Предписаните антропометричните променливи, от настоящите ръководства, бяха използвани за антропометричните измервания, докато за сравнение е използван Европейският стандарт EN 1729-1: 2015, приложен във всичките три държави. Въпросника за преподаватели включва общо 74 въпроса, а въпросника за производители 53 въпроса, разделени в пет раздела. Методът Mosaic се въвежда изцяло като нов метод в образователните институции. Този метод поставя потребителя (детето) на чело и събира възгледите на децата за проблема. Методът Mosaic се прилага в една детска градина, където на 36 деца се дава въпросник с картинки и те трябва да нарисуват идеалната си занималня за детска градина. Статистическата обработка се извършва с помощта на софтуерните инструменти MedCalc или IBM SPSS Statistics.

Получените резултати потвърждават хипотезите и посочват как функционалните размери на мебелите и оборудването не съответстват на антропометричните размери на децата, което не допринася за поддържането на здравословно и физически подходящо положение на тялото и не са използвани екологични материали. Резултатите доказват, че анализираният дизайн и конструкция на мебелите, използвани в детските градини, не отговарят на новите педагогически и психологически стандарти, препоръчани в литературата както и на препоръките, получени от разговори с възпитатели. Дизайнът, и размерите на мебелите не са подходящи за създаване на различни пространствени възможности в занималните на детските градини, където се провежда по-голямата част от образователния процес. По този начин се създават предпоставките за проектиране на нови решения и предлагане на нови начини за оборудване на наблюдаваните съоръжения.

Приносът на резултатите от изследването е представен в иновативните концепции и дизайнерски решения за продукти, които могат да бъдат разположени в занималнята, използвани от деца в различни възрастови групи в съответствие с подходящите педагогически насоки и образователни методи, които създават основата за израстване и развитие на здрави деца.

Дицертацията потвърждава, че е необходимо да се установи интензивно интердисциплинарно сътрудничество между различните професии по този въпрос при бъдещи изследвания и проектиране на мебели за предучилищни заведения. Само с правилен подход към здравословен растеж и развитие на децата, ние можем да положим основите за развитието на здрава общност и общество като цяло.

MENTORS BIOGRAPHY

Danijela (Janković) Domljan, Ph.D., Associate Professor, was born in Zagreb. In 1996 she graduated at the Interdisciplinary School of Design at Faculty of Architecture University of Zagreb (MA in product design). From 1996 - 2004 she worked as designer in company Tvin d.d. Wood Industry Virovitica, Department for rationalization, research and development. From 2004 she works at the University of Zagreb, Faculty of Forestry and Wood Technology, Wood Technology Section, Department of Furniture and Wood Products. As the first (and still only) designer in Croatia with Ph.D. in Biotechnology field, she is dealing with scientific research and teaching in the field of furniture design, methodology of design, interior equipping, furniture and health, contemporary values and cultural heritage in furniture design. Doctoral thesis "Design of the school furniture as prerequisite for pupils' health" she defended in 2011.

She participated in four EU IPA CQS projects and led a numerous professional projects and designers workshops, special enjoying in Designer drawing workshops with children. As well, she was researcher in a numerous scientific and professional projects. She wrote as the author or co-author over 100 scientific and popular science works; led, wrote, edited and published one University Manual, held more than 50 lectures at international conferences and was invited as guest lecturer to the several faculties (Sopron / Hungary; Prag, Brno / Czech Republic; Kuchl, Vienna / Austria; Thessaloniki / Greek; Ljubljana / Slovenia; Knoxville Tennessee, Ithaca NY, Gainesville Florida / USA, etc).

In 2019 she got UKF Scholarship at Cornell University with a project "Enhancing children's well-being by sustainable school furniture design".

She is a professional member of Croatian Designers Society, Croatian Ergonomics Society, Association for Industrial Design and a numerous other associations, working groups and technical and designers' commissions.

She got several designers recognitions and awards and specialy is proud on three on Halabala Awards for students projects. Danijela Domljan, PhD, associate professor supervised over 40 BsC and MA thesis. The work of Boris Iliev is her first supervising of doctoral thesis.

LIST OF ILLUSTRATIONS

TABLE OF FIGURES

Figure 1 A baby seated on a large bowl with hole cut for its feet.	7
Figure 2 Pestalozzi with his children.	10
Figure 3 Froebel Kindergarten	10
Figure 4 Montessori furniture.	10
Figure 5 Interior of classroom in nursery school.	10
Figure 6 Interior design of the playroom from 1928.	13
Figure 7 Suggestions (left, right) for organization of the activity centers.	16
Figure 8 Typical posture used in anthropometric data gathering.	22
Figure 9 Proportion of the head of a newborn and grown man.	26
Figure 10 Change in the proportion of the body from the fetal month to the end of adolescent age.	26
Figure 11 Height (left) and weight (right) curves between boys and girls.	28
Figure 12 Child anthropometry between children of the same age	32
Figure 13 Cubic seat with adjustable footrest.	34
Figure 14 Measuring anthropometric variables	34
Figure 15 The children romp in the flowery bowers and swings of the "Tree of Dreams".	40
Figure 16 Modern contemporary kindergarten playroom for 12 children, 18–24 months.	43
Figure 17 Modern contemporary kindergarten playroom for 24 children, 3–6 months.	43
Figure 18 Reference points for tables and chairs, with sloping front and rear seats.	53
Figure 19. Baseline seat reference points.	54
Figure 20 Anthropometric Measurement in Polygon I, II and III	58
Figure 21 Calliper.	58
Figure 22 Proportions of selected chairs among children.	136
Figure 23 Proportions of selected floor mats among children	136
Figure 24 Proportions of selected tables for drawing among children	137
Figure 25 Appendix V, question no. 4c.	138
Figure 26 Inadequate dimensions of chair with child growth. Too small or too large chair.	141
Figure 27 Significant discrepancies in chair dimensions with child growth.	142
Figure 28 Inadequate height of the chair, III polygon.	142
Figure 29 Inadequate height of the chair, III polygon.	142
Figure 30 Inadequate height of the chair, II polygon.	142
Figure 31 Sitting on the edge of the chair, II location.	142
Figure 32 Inadequate furniture size, II location.	142
Figure 33 Sitting on the edge of the chair while eating. II location.	143
Figure 34 Inadequate chair size, II location.	143
Figure 35 Inadequate body posture when playing.	143
Figure 36 Inadequate chair size, II location.	143
Figure 37 Inadequate height of the chair, I polygon.	143

Figure 38 Significant discrepancy of chair dimension with child growth, Polygon I	143
Figure 39 Inadequate height of the chair, II polygon.	144
Figure 40 Inadequate body posture, II polygon,	144
Figure 41. Examples of chairs that are inadequate for children's age in Skopje	146
Figure 42 Examples of chairs in Zagreb, where there are several different types of chairs in one room.	147
Figure 43 Posture of the back.	150
Figure 44 Extremes of size students using the largest size school chair.	151
Figure 45 Posture of the body in a seated position.	153
Figure 46 Chair for preschool age	153
Figure 47 Preschool chair	156
Figure 48 Preschool chair in playroom	156
Figure 49 Damaged tables.	161
Figure 50 Cabinets.	165
Figure 51 Storage furniture.	166
Figure 52 Condition of the audio-visual equipment.	167
Figure 53 a, b, c. Examples of spatial organization in Polygon I. Open space without partitions.	176
Figure 54 a, b, c. Examples of spatial organization in Polygon III. Open space without partitions.	176
Figure 55 a, b, c. Examples of spatial organization in Polygon II. Space with a partition.	176
Figure 56 Colorfull corridor	178
Figure 57 Example of corridor, before and after.	178
Figure 58 A playroom divided on small zones	180
Figure 59 Clearly defined spaces eliminate chaos.	180
Figure 60 Children's drawing 1	187
Figure 61 Children's drawing 2	187
Figure 62 Children's drawing 3	187
Figure 63 Children's drawing 4	187
Figure 64 Children's drawing 5	188
Figure 65 Children's drawing 6	188
Figure 66 Children's drawing 7	188
Figure 67 Children's drawing 8	188
Figure 68 Sketches of the dragon (multifunctional furniture elements)	194
Figure 69 Dragon, multifunctional furniture elemnt for play and work	195
Figure 70 Table ladybug.	196
Figure 71 Castle- a multifunctional piece of furniture for playing and sleeping.	197
Figure 72 Conceptual solution of playroom.	198
Figure 73 Intrior design of playroom.	200

TABLE OF TABLES

Table 1 Size marks for chairs and tables according to European standard EN 1729-1:2015	21
Table 2 Canons in chidren.	26
Table 3 Measuring anthropometric variables and their marks. Source: Domljan, 2011.	35
Table 4 Measurement of variables in chairs according to EN 1729-1:2015	53
Table 5 Measurement of variables in tables according to EN 1729-1:2015	54

Table 6 Description of the anthropometric variables included in the research	55
Table 7 Structure of the surveys for respondents – kindergarten employees	60
Table 8 Structure of the surveys – manufacturers.....	60
Table 9 Kindergartens included in the measurement methods.....	63
Table 10 Locations of the kindergartens in city area.....	64
Table 11 Number of children in a working group (playroom)	65
Table 12 Kindergartens included in the anthropometric measurements	65
Table 13 Kindergartens included in the survey method	66
Table 14 Distribution of respondents by survey method by location	67
Table 15 Types of chair	68
Table 16 Types of tables.....	74
Table 17 Types of children’s beds by polygons.....	79
Table 18 Types of storage furniture by polygons	83
Table 19 Distribution of children by age groups.....	89
Table 20 Distribution of respondents to preschool children by polygons	90
Table 21 Distribution of respondents – teachers: by job position	92
Table 22 Years of work experience of respondents – kindergarten employees.....	92
Table 23 Producers/distributors and basic characteristics	93
Table 24 The functional dimensions of the chairs	96
Table 25 Functional dimensions of tables	99
Table 26 Functional dimensions of beds.....	101
Table 27 Functional dimensions of storage furniture	102
Table 28 Differences in anthropometric parameters regarding gender (in age between 2-3).....	105
Table 29 Differences in anthropometric parameters regarding gender (in age between 3-4).....	106
Table 30 Differences in anthropometric parameters regarding gender (in age between 4-5).....	106
Table 31 Differences in anthropometric parameters regarding gender (in age between 5-6).....	107
Table 32 Differences in anthropometric parameters regarding gender (in age between 6-7).....	107
Table 33 Differences in anthropometric parameters regarding gender (in age between 7-8).....	108
Table 34 Differences between anthropometric parameters regarding polygons (in age between 2-3).....	110
Table 35 Differences between cities/polygons regarding anthropometric parameters (in age between 3-4).....	110
Table 36 Differences between cities/polygons regarding anthropometric parameters (in age between 4-5).....	111
Table 37 Differences between cities/polygons regarding anthropometric parameters (in age between 5-6).....	111
Table 38 Differences between cities/polygons regarding anthropometric parameters (in age between 6-7).....	112
Table 39 Comparison of types of chairs with EN 1729-1:2015	115
Table 40 Comparison of types of tables with EN 1729-1: 2015	116
Table 41 Distribution of chairs that fit the lower leg of the children between the locations	117
Table 42 General data on respondents	119
Table 43 Properties of the kindergartens and their activity rooms/playrooms	120
Table 44 Description of activity room in kindergartens (current state)	121
Table 45 Playroom, opinions of the teachers what is should be like	122
Table 46 Questions regarding children’s chairs (current state).....	123
Table 47 Questions regarding children’s chairs, opinions of the teachers what is should be like.....	124
Table 48 Description of the children’s tables	125
Table 49 Description of children’s beds.....	126

Table 50 State of cabinet furniture.....	127
Table 51 Opinion on cabinets furniture.....	128
Table 52 Satisfaction with activity room design and working conditions	128
Table 53 Distribution of responses in survey used among furniture manufacturers	130
Table 54 Distribution of responses in survey regarding tender procedures	132
Table 55 Distribution of responses in survey regarding the construction of the furniture.....	133
Table 56 Distribution of responses in surevy used among furniture manufacturers- design.....	134
Table 57 Distribution of chaires that fits standard among poligons	148
Table 58 Suggestions for effective depth of seat	152
Table 59 Comparison of popliteal height - seated with height of seat (h8) according to EN 1729-1:2015	158
Table 60 Preschool tables and chairs size in standards JUS D.E4.021:1965 and JUS D.E4.022:1965	235
Table 61 Preschool chairs size in standards Bulgarian standard BDS 8475 – 88.....	235
Table 62 Preschool tables size in standards Bulgarian standard BDS 8475 – 88.....	236
Table 63 Comparison of types of chairs with D.E4.022:1965.	238
Table 64 Comparison of type of chairs with BDS 8475 – 88	239
Table 65 Comparison of type of tables with BDS 8475 – 88.....	239
Table 66 Comparison of types of furnitures with the ulebook	240

TABLE OF CHARTS

Chart 1 Share of children between investigated location.....	103
Chart 2 Frequency regarding age differences among children between gender	104
Chart 3 Differences in Head height regarding gender between children of different age	105
Chart 4 Frequency of the children’s age between cities	108
Chart 5 Maximum reach in heigh between age group in locations.....	112
Chart 6 Popiliteal height between age group in locations.....	112
Chart 7 Knee height between age group in locations	113
Chart 8 Upper leg height, buttock - popiliteal length between age group in locations	113
Chart 9 Width of the bottocks (seated) between age group in locations	113
Chart 10 Sitting height between age group in locations	114
Chart 11 Proportions of examined chairs among investigated locations	117
Chart 12 Number of examined chairs that fit the height of the children’s lower legs regarding age groups	118
Chart 13 Proportions of examinees between investigated cities/polygons.....	118
Chart 14 Number of selected table color.....	137
Chart 15 Number of selected chair color.....	138
Chart 16 Frequency of colors used to color in squares.....	139
Chart 17 Frequency of colors used by boys.....	140
Chart 18 Frequency of colors used by girls	140
Chart 19 Proportions of examined chairs regarding fit or not fit to the standard	148
Chart 20 Division of popliteal height seated by age of children according to EN 1729-1: 2015.....	159

1. INTRODUCTION

Preschool institutions, also called nurseries or kindergartens, are institutions in which the educational process of children aged 9 months to 7 years is performed, i.e. before starting elementary school. During this period, children experience the greatest physical and mental changes. Hence, more attention should be paid to design and equipping this type of institutions, both from the educational and architectural-organizational aspect, as well as from the aspect of the furniture design used in the space (both interior and exterior). While designing furniture and equipment for kindergartens, the question of their quality and design values are approached as the least valuable for discussion. The furniture is usually seen as a functional object in the space, presented only as a seating element - a chair, an element for performing mental activities and eating - tables, etc. and nothing beyond that. Children's furniture is designed mostly as copies of the already existing furniture used by adults, but with reduced dimensions. This approach does not go in favor of the children and to improve their proper psycho-physical development, because very little is taken into account in terms of their needs of playing and imagination, especially from a pedagogical, psychological or physical point of view (Dudek, 2000; Ivanović Šekularac, 2000; Dragostina-Dobreva, 2013; Iliev et al., 2018).

The influences that children are exposed to in preschool period are very large, and in addition to the biological and physiological factors, the factors of social, economic type, family, environment and surrounding are also influential (Prebeg and Prebeg, 1985; Burić, 2006; Domljan, et al., 2015). The environment is conditioned by the organization of the space in which the children stay, be it preschool institutions or children's rooms in the residential units in which they live. In kindergartens, such rooms are called also playrooms. The arrangement and equipping of playrooms, as well as the design of the furniture suitable for the needs of the children, should not be neglected, but through thorough research it should be improved and modernized. This will also show the effect of whether, how and to what extent they affect the stimulation of personality development and children's health (Dudek, 2005; Domljan, 2011; Falk, 2019).

The number of children covered in the educational process in preschools varies from country to country, but worldwide, in highly developed countries it ranges from 40% to 90% (Ivanović Šekularac, 2000). The number of children who attend preschool institutions varies

1. INTRODUCTION

from 20 % to 30 % of the total number of preschool children in the countries of conduct of this research, Skopje Republic of Nord Macedonia, Zagreb Republic of Croatia and Sofia Republic of Bulgaria. The fast pace of life, the struggle for existence, the work responsibilities of both parents, have necessitated the increasing need for children to be cared for in preschool. This, in turn, imposes the need for new preschool facilities and their proper equipment (Iliev, 2011).

During the construction of new preschool facilities, as well as in the old buildings that are subject to renovation, not enough care is taken whether the basic elements required for their proper use are fully observed. The involvement of politics is also influential in the process of designing, building and equipping the preschool facilities. Namely, the management and financing of the kindergartens is mostly done under the jurisdiction of the state or local self-government units (small part are private kindergarten). In such circumstances, in order to raise its political rating, especially in pre-election periods, the competent authorities often stimulate and accept hasty projects and solutions, to the detriment of the quality of facilities and equipment. This is followed by the not always well-defined requirements in the public procurement procedures, in which mostly criterion is the lowest price. In this situation, the competent authority, without the possibility of qualitative selection, accepts the offer that offers an incomplete, inexpensive, low-quality and poorly designed product. In addition to this is the fact that the financial resources allocated for this purpose are usually limited and very small (Ceppi and Zini, 2001; Auf-Franić et al., 2003; Dudek, 2008; Domljan, 2011; Iliev, 2011; Klein, 2014; Ivanova, 2015).

The inadequate furniture that is present in the preschool facilities today is a product of the rigid and bureaucratized administration that most often does not accept and does not allow new innovative design solutions. The reason for that is the fact that the kindergarten staff, as end users of furniture and equipment, are almost never involved in these issues. This issue is directly or indirectly related to the interdisciplinary factors and requirements that are in the modern preschool environment, which affect the health of the children, and which are also not sufficiently involved and consulted in this process.

Analyzing individually the elements of furniture that are in the preschool institutions, at first glance it is concluded that they are not such bad examples for the conduct of daily activities. But, when you look at the whole picture, most of them do not even remotely meet the basic conditions for the daily educational process and do not follow the psycho-physical development of children.

1. INTRODUCTION

In urban areas with distinct populations, in terms of language barriers, as well as cultural, religious, ethnic, and other differences, kindergartens provide an opportunity for the population to integrate, because children very easily establish communication and social interaction. Architecture can help in this process, representing a social catalyst. Therefore, designing preschool facilities as well as designing the furniture needed to equip them is a very sensitive process. The truly end users of these facilities, the children, need to identify with these institutions in order to encourage a rational, emotional and most of all personal attitude, so that they can feel the preschool object as their second home. On the other hand, through the educational process that is carried out in these institutions, they can more easily master and accept the tasks assigned to them by the teachers. All this can be achieved only based on the quality of the spatial environment and the equipment in it (Auf-Franić et al., 2003; Dudek, 2008; Iliev, 2011; Remenschneider, 2017; Stoecklin, 2007; Vodenova, 2017).

The playrooms, in which almost all activities are performed during the day should be the most susceptible to change and adaptation. Proper spatial organization leads children to acquire good habits to fulfil their responsibilities, to improve social interaction, in preparation for further life (Stanković, 2009; Iliev, 2011; Ivanova, 2015).

In addition to the proper organization of space, one of the important elements for the psychophysical development of the children is the correct way of sitting and performing tasks in a sitting position. Therefore, proper design of furniture elements that suit the age of children is crucial for the proper forming and development of their bodies. In order to design elements of furniture that will correspond to their age, it is necessary to pay more attention to the anthropometry of the children. In order to enable the proper growth and development of preschool children, in addition to adjusting the environment in which they stay, it is necessary to use ergonomic furniture, which will monitor the anatomy and size of the child's body (Zini, 2006; Stoecklin, 2007; Iliev, 2011; Wardle, 2011; Wiser, 2011).

A very careful approach is essential in designing furniture for preschool children, taking into consideration two aspects. The first aspect is the child's anatomy. During the earliest years of childhood, the spine column, much like the rest of the bones, is not fully formed, hence the proper utilization of furniture is of great importance. If the seating element is designed according to the needs of the children, i.e., it follows the body line, this will lead to proper development of the body. The second aspect is the size of the furniture. Items of furniture that are too big or too small also lead to an anomalous physical development. One of the most common curvatures of the spinal column is the scoliosis, which is a curvature in the "coronal"

1. INTRODUCTION

(frontal) plane, and kyphosis, which is a spinal curvature of the thoracic vertebrae in the form of a hump. Besides the spinal curvatures, which are the most common ones, deformities occur with the legs as well. This phenomenon is a result of the too small dimensions of the chairs which forces the legs to an improper posture. A research conducted by the specialist psychiatrists Prim. Dr. Velika Labachevska and Prim. Dr. Lidija Ivanovska¹ regarding the spinal column curvatures of 4,609 children, has yielded the following results:

- 1,168 children or 25.3 % have spinal curvatures in the form of scoliosis,
- 339 children or 7.4 % have curvatures in some form of kyphosis.

All of the above create the basic assumptions for further research pooled in this dissertation. On the contrary, they will try to prove that today's everyday design solutions of furniture used in kindergartens as well as spatial organization can causes discomfort to the children when they do daily activity and often to health consequences. New solutions and proposals aim to eliminate or at least reduce these symptoms and achieve the ultimate goal to preserve the health of children. However, further interdisciplinary research is yet to be achieved this ultimate goal.

¹ The data were obtained in conversation (interview) with the two doctors, at that time employed at the Institute for Rehabilitation and Physical Therapy in Skopje Republic of Macedonia.

2. THEORETICAL BASIS AND ANALYSIS OF THE TOPIC

In the facilities for preschool education and upbringing (hereinafter: kindergartens) a process of organized form of acquiring knowledge, skills and habits takes place and the physical, mental, cognitive, social and other abilities of the children from the preschool period are developed (Nikolovska, 2002; Dudek, 2008; Stanković, 2009). The importance of influencing the upbringing and educating of children are even more important when it comes to such a system that considers only a small segment, which also has an unavoidable impact on the psychophysical, cognitive and social development of the young being - the subject environment, furniture, equipment, didactic toys, as well as other elements in the space (Domljan, 2011). Most recent literature on this issue deals with doctoral thesis (Yarbrough, 2001; Pasalar, 2003; Domljan, 2011), textbooks, books, and manuals (Dudek, 2000; Auf-Franić et al., 2003; Dudek, 2008; Domljan et al., 2015) who at a scientific and professional level observe the problems, opportunities and directions on how to approach the architecture, the design and the construction of new spaces and products (equipment), according to the modern requirements of the children and the educational staff in the kindergartens and other educational facilities. Unfortunately, modern methods of preschool education go beyond the design and quality of wood products (furniture, didactic toys, and equipment) that children use daily in play, work and leisure, and more attention is paid to modernizing methods than the products and equipment with which those methods are conducted (Gigov, 2007; Stoecklin, 2007; Wardle, 2011; Wiser, 2011).

In early childhood development, as a result of intentional or unintentional environmental influences and maturation, significant changes in physical, intellectual, and social functions occur, affecting the child's personality as a whole (Genchov, 1967; Vasta et al., 2005). The preschool development period is different from other periods in a person's development, primarily because it is a time of the busiest growth and development of the child (Nikolovska, 2002).

Because the process of biological maturation of the child from an early age is very intense, its nervous system and mental functions are subject to the influences of the environment around it. This is especially important for those circumstances that are particularly striking and

powerful and that have lasting effects on the child. Such external influences on the child's personality in the preschool period, whether positive or negative, are crucial to his or her further development (Stevanovič, 1970; Nikolovska, 2002; Stevanovič, 2001).

It is known that the development process that takes place in this period greatly affects subsequent years and that 60-70% of the learning ability is acquired in the preschool period (Şahin and Turkun Dostoglu, 2012).

The process of preschool education contributes to short-term and long-term effects on children and society since early childhood development and the basis for its social development. The quality of the physical and social environment in this process of education is crucial to the children's development. In order to improve the conditions of the physical environment, designers can, and should try to achieve the best design solutions, attracting ideas that lead to improvement of the conditions of the educational environment of the children (Stanković, 2009; Yalcin, 2013; Remenschneider, 2017; Vodenova, 2017).

2.1. HISTORICAL OVERVIEW OF THE DEVELOPMENT OF KINDERGARTEN FURNITURE

Childhood and the upbringing of children have not always been treated as modern pedagogy, psychology, and sociology do today (Kamenov, 1988). "Education is a social phenomenon, which means that it is largely socially conditioned (...) Historical studies show that many of our notions of childhood, family, parenting, school, children's relationship with adults, etc., have generality and durability" (Kamenov, 1988). Historically, the notion of childhood and attitudes toward children has changed dramatically. In ancient Greece and Rome, children were treated as possessions that could be "exchanged" and "spent." At this stage, the military-gymnastic schools in Sparta; gramatista, gitarista schools and high schools in Athens; and the Ludus and Humanitas schools in the Roman Empire. Children from the fifth year of school attended classes in these facilities, which did not fully cover the preschool period of the children. (Vasta et al., 2005; Iliev, 2011). The architecture of the education of young children aged 5 or 6 to 11 years has been a distinct building type for over a century. Early years architecture for preschool children aged 0 to 5 years has been less distinct (Dudek, 2008). Therefore, the lack of specialized buildings intended for preschool education and learning and the lack of understanding and non-existence of childhood as a category, logically led to this type of children's furniture, in this period not to be produced or improvised.



Figure 1 A baby seated on a large bowl with hole cut for its feet.
Source: Luice-Smith, 2005

In the Middle Ages, the church raised awareness in society of "childlike purity and innocence." On the other hand, it allowed only religious explanations for human behavior, which did not allow scientific research for the child's development and psychology. These views are revived only in the Renaissance. In the tenth and eleventh centuries there was no judgment that children are something special and that this distinction essentially distinguishes them from adults and even from other young people. Throughout the middle Ages, the child was not separated from the adults, more precisely, childhood was a completely vague and undefined concept. The children attended parties where they could see everything, even naked parts of the adults' bodies. The child was seen as a "pet", as something "sweet", and they had fun with him/her as if with an animal. During this period, in addition to not paying attention to the education and upbringing of children, the family as an institution was also not given emotional and psychological security, in which they would develop smoothly. Therefore, the family was not created out of love, but primarily for the sake of life, in order to maintain the offspring and ensure their existence. The child immediately became a young man, without going through the stages of childhood (Kamenov, 1988; Aries, 1989; Vasta et al., 2005; Iliev, 2011).

Childhood perceptions and attitudes toward children began to change in the late 16th and early 17th centuries. Then the term "innocence" appears as a synonym for a child. Attention was paid to what has been discussed and done in front of them, and various restrictions and controls were introduced that should tailor children's interest in their own benefit. The child was seen as a helpless being, to whom special attention and love should be given, and who must

be brought up and educated in order to grow and develop into a mature person. From then until today, the view towards the child has changed and improved both psychologically and educationally. Thus, the whipping of children in the 17th century began to be abandoned, as it was considered to humiliate the soul, with the exception of England, where it has been retained for a longer time (Kamenov, 1988; Aries, 1989; Vasta et al., 2005; Iliev, 2011).

Historically, the notion of childhood, as well as the view and attitude towards children has changed. From ancient times when children were presented as victims of the gods, to this day when children have their rights and are considered as individuals from birth. With the change of consciousness in society, many new disciplines and sciences have emerged that explore childhood. The child gradually began to occupy a central place in the family. One of them is the emancipation movement of the child, which contributed to the proclamation of the twentieth century as the "century of the child." In 1924, the first "Geneva Declaration of the Rights of the Child" was adopted, and in 1959, the United Nations adopted a new "Declaration of the Rights of the Child" (supplemented and amended over time) (Kamenov, 1988; Aries, 1989).

With the advancement of the opinions and attitudes towards the child that have been affirmed by many philosophers, psychologists, pedagogues, sociologists, the need for appropriate education and upbringing of preschool children has been imposed. The need for proper care has led to the creation of institutions that will take care of and later educate children. The idea of the emergence of children's preschool institutions has existed since the XVII century, when a small group of citizens from European countries became interested in the social changes they entered and promoted the idea of proper access to children. The family begins to organize around the child and give him/her more importance. The industrialization and the modern understanding of the children enabled the opening of preschool institutions, in which care, educational and upbringing activities are performed. In addition to children whose parents are unable to care for the child throughout the day, preschools are also visited by those who are not affected by this condition, but for the purpose of child's socialization and proper progress (Kamenov, 1988; Aries, 1989; Vasta et al., 2005).

The beginnings of a kind of children's preschool institutions emerge in the second half of the 18th century, when the grouping of small children's groups in Steithal, in Waldersbach, by the evangelical priest Oberlina, for social and economic reasons, was observed. There is seen the necessity for the children to be kept while their mothers were at work (Ivanović Sekularac, 2000).

The roots for the modern organization of preschool education were defined by the Czech pedagogue Jan Amos Komenski. He explains the purpose of preschool education in his book *Didactica Magna*, where he defines “mother school” as the first step in the educational process (Bognar and Matijević, 1993; Dzambo, 1993; Roth-Čerina, 2015). Today's name Kindertagens comes from the German pedagogue Friedrich Flobel (1782-1852), who first introduced the term to institutions of this type. His pedagogical views spread to other European countries, so this name has been taken for institutions of this type in the English-speaking world as well. From the beginning of the creation of preschool children's buildings to the present day, a number of changes have been made and revolutionary ideas have been introduced, what exactly they should look like, how they should be organized, and so on. Following the example of Friedrich Flobel, several preschool childcare facilities have been opened. Johann Heinrich Pestalozzi (1746 - 1827) founded the first child-centered institution, at Yverdon in 1805. Although not specifically for younger children, it was based on what became the essential kindergarten principles. Ten years later, following a visit to Yverdon, philanthropist Robert Owen established a childcare institution in his ideal industrial community New Lanark, Scotland (Žlebnik, 1955; Jakopović, 1984; Dudek, 2000).

The example is followed by a number of pedagogues, psychologists, sociologists; as Sir William Mather who founded first kindergarten in the north of England in 1871, then Ronge sisters's kindergarten in London in 1851; In the USA the first kindergarten was established in 1856: in Germany, in the wake of Frobel's revolutionary ideas, kindertagens were established in many centers after 1840 (Dudek, 2000).

Preschool facilities can be seen as a phenomenon that developed across national borders during the latter part of the 19th century and the first third of the 20th century (Dudek, 2000). Today's kindertagens began to take shape after the 1920s, when revolutionary buildings began to be built using new materials. Many architects have been involved in the creation of unique buildings of this type. Among them was Walter Gropius, who designed the unfinished preschool for the Clary Peabody Trust in 1937. It is important to mention not only the architectural style, but also the spatial organization of the building itself. Le Corbusier is also included, with the unique idea of building a children's space at the top of the Unitè building. Other well-known architects, designers involved in the creation of preschools are Paul Klee, Vasilij Kandinski, Frank Lloyd Wrih and many others. In addition to architects, pedagogues such as Maria Montessori, Rudolf Steiner, Loris Malaguzzi and others also participated in the construction of

2. THEORETICAL BASIS AND ANALYSIS OF THE ISSUE

the buildings (Ivanova, 1984; Delchev, 1993; Dudek, 2000; Roth-Čerina, 2015; Vodenova, 2017).

In the available, processed literature there is scant information about the furniture used in preschool facilities. The only source of information is the drawings and pictures as well as the small number of texts found for this type of furniture. In the Figure 2 there is no furniture in the room of the school where the children are staying, so they are sitting on the ground. On the wall are tables to aid the teaching of counting and drawing. More information about the interior and children's furniture has been found for the period from the end of the XIX century. In the Figures from 2 to 5, the furniture, which is shown, has been tailored to the needs of the children.

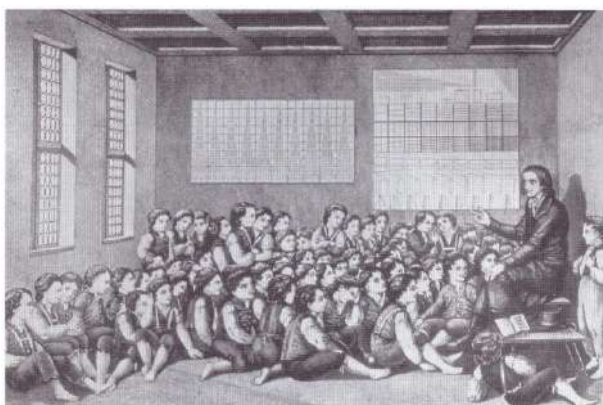


Figure 2 Pestalozzi with his children.

Source: Dudek, 2000



Figure 3 Froebel Kindergarten

Artists impression of a Froebel Kindergarten showing at The Centennial World Fair in America. The children are playing with the Froebel 'gifts' at the table. Source: web

1



Figure 4 Montessori furniture.

In 1932, P. Johannes Müller presented a room fitted out with Montessori materials on the occasion of the congress for infant education in Berlin. Source: web 2

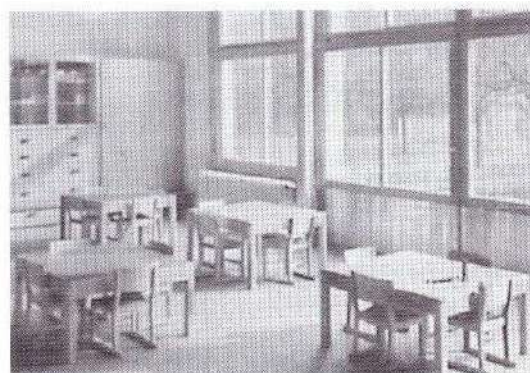


Figure 5 Interior of classroom in nursery school. Designed by Hans Leunzinger in Zurich in 1934.

Source: Dudek, 2000

With the change of mind about the upbringing and education and the sociological changes of the late nineteenth century, the furniture intended for preschool children began to change. The furniture began to adapt to the age of the children, i.e. to adapt and pay more attention to the needs of the children. The furniture was designed to be lighter, allowing children to move it on their own. "The bed that the children can move on their own is different from the cradles, which is designed in accordance with the laws for beauty and comfort; It differs from the adult bed in terms of the fact that children can be comfortably stretched out and put to sleep in it, any time they want. The so-called children's beds - cradles are "shackles", on which the parent places the child and thus commands the needs of it. Children are prisoners of the civilization created by adults. They should have the right to sleep when they are asleep, to wake up when they have slept enough, so the beds which are low, almost to the floor, change and facilitate the mental life of children" (Montessori, 2003).

We should not think that the "ambience" of the first children's houses was comfortable and beautiful, as it is now in our institutions. The furniture was a solid table for the teacher, housed in a dominant place and a large closet, made high and solid, on which many items could be placed, where the doors were locked, and the key was kept by the teacher. The bench (tables) provided for children were made according to the criterion to be durable and solid; they were long enough for three children to sit in a row; placed one after the other, as the classical benches in the schools. The only innovation were the single individual small chairs, one for each child. Flowers were missing (Montessori, 2003).

With the advent of mass education, the view has been copied, meaning that the main role of society - the state - was to control and discipline children, in order to create strong citizens who would fit into the new industrialized world. "The effect of this education is to create dissatisfied children and students who are more chaotic and less disciplined" (Dudek, 2005). As a result, individualism emerged as a new system in the educational process. Maria Montessori was the proponent of this idea. Montessori's pedagogy aims to respect the child and his individuality. She considered that "children would develop very successfully only if they received the necessary external stimulus in time and when they live in tidy environment and that children's social backwardness is more of a pedagogical than a medical problem" (Stevanović, 2001), "The first 6 years are the most important, because this is a period when the child becomes particularly sensitive to the development of a learning ability. The young child is at the level, as she calls it, "creative", through which she/he learns with her/his senses, everywhere and constantly, he/she learns unconsciously through the senses, being in a constant

movement "(Rot-Čerina, 2015). Montessori emphasizes that the purpose of raising preschool children is not to transfer certain knowledge, but to enable children to develop freely through their interests and abilities (Montessori, 2003; Philipps, 2003).

In 1907, Montessori opened the first "Casa dei bambini" kindergarten in San Lorenzo. The kindergarten had furniture that matched the child's age. She also developed a special material for the development of children's senses (didactic sensorimotor materials) (Stevanović, 2001). The furniture has changed shape, become more aesthetic, rounded, less cruel and can be said to be more organic (Vodenova, 2017). On the other hand, the furniture², i.e., its construction was lighter, so that the child can move it freely without the help of adults. "The tables and chairs in the playroom are set up thus to perform more activities. (...) Children also do activities on the floor where they naturally feel best." (Stevanović, 2001). In this way, the furniture was harmonized with the newly created pedagogical norms, free movement, and children's play.

"One day the teacher was late for school, and the day before she forgot to lock the cabinet. She found the closet open and many children by its side ... The teacher attributed this act to the stealing urge. In her opinion, children who steal and have no respect should be punished. It seems to me that the children know the subjects well enough and can choose for themselves, and what they did was exactly that. Because of this, we procured a low elegant cabinet that was better suited, in which the accessories were better organized and within the reach of the children who chose their things more easily according to their choice. Greater intelligence was initiated, children showed more activity and chose their own activities. Thus, the principle of free choice has joined the principle of repetition of exercises" (Montessori, 2003).

One of the first "children's houses" in Rome is an impressive and important example. It housed orphans after the catastrophic earthquake in Messina (Montessori, 2003). *They were frightened, silent, and absent, feeding was difficult as well as the moment of falling asleep. "There is a room for their needs. Miniature furniture was made, bright, shiny and varied; small cabinets, colored curtains; round tables, low in height and in strong colors, rectangular tables that were higher and brighter small chairs with backrest; the dishes were attractive, small plates, cutlery (...) there was an ornament on each piece of furniture (...). Beautiful pictures on*

² From 1913 – 1935, P. Johannes Müller, VS's Berlin-based founding company, held the sole right to manufacture and distribute Maria Montessori furniture and teaching materials in Germany. An appropriately fitted out Montessori children's room was presented at the 1914 German Werkbund exhibition in Cologne – the first time in Germany it reached a wider public.

the walls and flower pots (...) the rapid transformation of these children caused a deep impression; one could see children happily carrying objects in the garden; they move the furniture, but nothing breaks or hits, a cheerful and happy image (Montessori, 2003). After a while, the children began to eat normally, to sleep, and simply became happy. Taking care of the children and the approach to the educational process itself are not the only condition for their change. The environment itself, that is, the interior and the furniture, also influenced that (Montessori, 2003).



Figure 6 Interior design of the playroom from 1928.

Simple and clear structure. A Children's House has clear, structured rooms or areas for different activities. The large activities room allows room for exercise. Children's House in Altona, 1928. Source: web 3

Another pedagogue who strongly influenced the development of preschool institutions was Rudolf Steiner (1861-1935), the founder of Waldorf Kindergartens (Carlgrén, 1990). The first Waldorf school was founded in 1919 for the children of employees of the Waldorf-Astoria-Stuttgart cigarette factory, at the joint initiative of Rudolf Steiner and the factory's head, after which the school received its name. Steiner emphasized the importance of the environment and heritage for child development. He believed that upbringing (pedagogy) should not be carried out only in a theoretical or predetermined program, but in a way that teachers develop their intuition through regular monitoring and research of children's behavior. Based on the insight they draw conclusions about the way of the optimal improvement of the conditions that are influential for the upbringing of children. Hence, Steiner believed that the upbringing of children in kindergartens did not require any prearranged curriculum, because the time and content of the activities should be based on the change of the seasons, through play, through drawing and storytelling. A separate game has been organized characterizing each season of the year. Waldorf's pedagogy is based on the claim that a child should develop according to his or

her childhood ability, and not from preset goals that the child should achieve (Premerl, 1973; Carlgren, 1990; Krauth, 1993; Stevanović, 2001; Dteiner, 2002; Rot-Čerina, 2015).

Waldorf Kindergarten is dominated by peach color, which is transparently applied to the walls so that the space can show "life". The whole space, and especially the tables, mark a certain time of the year or a certain holiday. The wardrobe, kitchen and laundry room were different from the other modern kindergartens at the time. There was a difference in the toys as well. They were made only from natural materials and in their shape, surface and color are as original as possible. There are no technical toys and construction toys at all, and picture books are rarely used. Dolls, animals, wooden toys, and natural materials are present on the shelves and in the baskets (Krauth, 1993; Dudek, 2000; Stevanović, 2001).

Another important pedagogical movement is expressed through the "Reggio" kindergartens, which began operating in 1965 in the Italian province of Reggio - Emilia. The founder of "Reggio" is Loris Malaguzzi (Stevanović, 2001). "The Reggio Emilia Approach is an educational philosophy based on the image of a child with strong potentials for development and a subject with rights, who learns through the hundred languages belonging to all human beings and grows in relations with others" (web 4). Reggio kindergartens are organized as "kindergartens", with a maximum of 4 groups. The garden is open to itself and towards the outside. There are several separate centers (zones) with different purposes, in which the children freely explore and spend the time. The child thinks and plans how he / she will organize his / her activities for the next day and does not expect only from the mentor to solve it. In this way, the teachers do not exercise direct control over the children. The children have fun on their own, negotiate, associate, and move freely from one group to another. In the educational process in Reggio kindergartens, not only the relationship between the teacher and the child is important, but also the relationship between a child with a child is important, in order to exchange feelings, ideas, attitudes. This is an institution that maintains the well-being that the teachers, parents, and children have built. This is an institution that provides an opportunity for exchange of different thoughts and discussions (Stevanović, 2001).

Great attention is paid to space and its arrangement in preschool institutions. It should provide activity in large and small groups of children, as well as individual work. The space should be challenging and appealing. It should be organized not only for physical and intellectual activities, but also for children's recreation (Smoljanović, 1986; Stanković, 2009; Klein, 2014). It must unite the senses of the past, but also the challenge of the present. The space in the kindergartens should also be distinguished by the following: upon entering the

kindergarten, in the communication rooms, which according to the concept of "Reggio" is called a square, a string of information, messages, guidelines, lists for the parents are glued. The greatest part of the space is dedicated to children's expression and through graphic language, which presents the child's idea, observation, memory, fantasy, sensation, etc., with other words the total "speech" of children. This is in order to attract the children to the wish of returning again and again back to the facility.

After the Second World War, in most of the Western world, the organized pedagogical educational process was included in the legislation that regulated education, and the responsibility for children and their daily care was increasingly taken over by the state (Rot-Čerina, 2015). The population growth in the cities, as well as an increase in the number of employed women, has led to the need of building more preschool institutions. Many countries had state-run pedagogical programs that taught in children's institutions. Some of these national programs in certain countries continue to follow the "pure" form of upbringing, according to the methods of Montessori and Waldorf pedagogy (Rot-Čerina, 2015). However, in most European countries there is a certain discrepancy between the norms for hygienic and technical requirements and the development of children's psychology and the pedagogical process (Rot-Čerina, 2015). In the region, the pedagogical processes and the arrangement of the premises in the kindergartens is done according to the curriculum established by the Foundation for Educational and Cultural Initiatives, - Regional Educational Program "Step by Step"³ (Walsh Burke, 2004). This method is based on modern pedagogical - psychological principles of children's learning. It stems from constructivism and the developmental learning of the children through examples. Unlike the old teachings that are focused only on the teaching process, this new methodology is aimed towards the child, which means that it observes the child as a being and develops it in its entirety, starting from all its developmental-psychological characteristics (Walsh Burke, 2004). This educational program encourages the children to become active citizens and to accept a democratic lifestyle. Children are also encouraged to express their

³ The "Step-by-Step" Educational and Cultural Initiative Foundation was established as a non-governmental organization to continue the activities of the regional "Step-by-Step" educational program, established by the Open Society Institute in New York and Georgetown University from Washington. The International "Step By Step" Association (ISSA) fully supports and follows ISSA's international principles for achieving quality pedagogical practice:

1. Interaction filled with understanding and respect between adults and children, as well as in children's mutual relations;
2. Involvement of the family and the community in the education of the children;
3. Inclusion, respect for the differences and values of democracy for each child and his/her family;
4. Assessment and planning for a quality teaching process;
5. Strategies and teaching techniques that encourage curiosity, research, critical thinking and collaboration.

2. THEORETICAL BASIS AND ANALYSIS OF THE ISSUE

opinions, to ask questions and to discuss, to emphasize mutual respect, mutual responsibility between adults and children, values of respect, to care and to be diligent (Walsh Burke, 2004; Marković et al., 1997).

According to the "Step by step" method, the most obvious and at the same time the best way to organize the materials in the space was to organize the playrooms in the learning centers. The centers should be grouped so that similar teaching content is performed in the same group or next to each other. For example, children who make constructions with the help of cubes should be separated from those children who work in the art center. Accordingly, similar centers should be grouped together, but separated from other centers by different activities. The centers can be divided into art center, writing center, drama center, research center, etc. Example is shown in Figure 7.

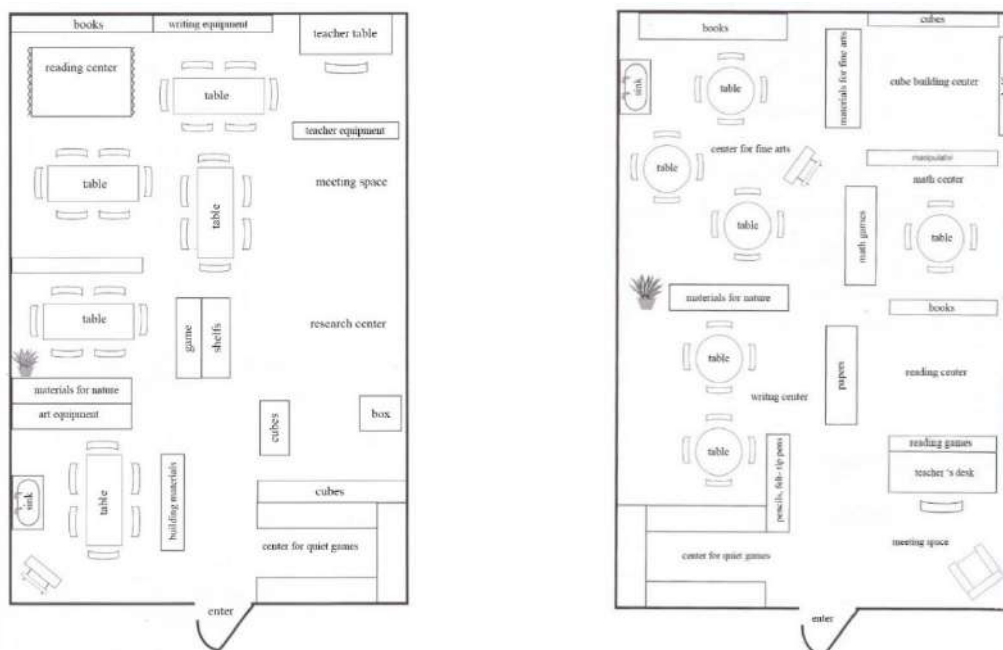


Figure 7 Suggestions (left, right) for organization of the activity centers.

Source: Walsh Burke, 2004

Each area should be defined by boundaries that separate them from the other areas. The boundary markers can be low storage shelves, bulletin boards, or even tables and chairs. These boundaries should mark the location of an area in the classroom's organizational scheme without inhibiting children's activity (Falk, 2019).

It was not until the 19th century that children's furniture began to be produced, which to some extent began to be produced industrially. This is due to the industrial revolution, which is gaining momentum during this period. An example of children's furniture from this period is the high feeding chair, designed by Thonet. "After the success of this product, designed for

children, it designs and launches an improved version, which very easily transforms from a high feeding chair into a toy chair, and when the wheels are removed, it can also serve as a table" (Vodenova, 2017). In addition to this product, Tonet also designed a cradle. His products, with the new technology he created, were characterized by a strong and solid construction, saving material and easy to manipulate. The mass production of children's furniture began in the early twentieth century, when it gained its present appearance in terms of ergonomics, anthropometry, construction and design. Many famous architects and designers have created an element of children's furniture in their creative path. Gerrit Rietveld in 1919 designed the high feeding chair; Peter Keler is known for his famous crib for nursery groups; Marcell Breuer is known after the set of tables and chairs; Alvar Aalto with the chair 65, developed for children's variant in 1950; Arne Jacobsem - In 1956 designed a table and a chair that was in three different sizes, adapted to the age of the children and many others. All of these pieces of furniture may not have been intended for use in preschool, but they certainly influenced the design of the furniture used in them (Vodenova, 2017).

2.2. PRESCHOOL EDUCATIONAL SYSTEMS IN THREE OBSERVED COUNTRIES

The care and upbringing of preschool children is a form of child protection, which as an activity is organized for care, accommodation, nutrition, educational, sports-recreational, cultural and entertainment activities, acts, and activities to improve and preserve the health and to encourage the intellectual, emotional, physical, mental and social development of the child up to six years of age, i.e., up to his enrollment in primary school (***, 2013). As the research conducted in this thesis is related to three observed countries: Republic of North Macedonia, Republic of Bulgaria and Republic of Croatia, it is valuable to describe the organizational set-up of preschool system in all three countries. There are some similarities, but also some differences important to mention.

2.2.1. Republic of North Macedonia – organizational set-up of preschool system

The preschool institutions in the Republic of Macedonia (***, 2018a) are divided into three units:

- A. **Nursery groups**, which include children from six months to two years, divided into a small nursery group (6-18 months) and a large nursery group (18-24 months).

B. **Kindergartens**, that cover children from two to six years old, divided into small group (2-4 years), middle group (4-5 years) and large group (5-6 years) children.

C. **Combined groups**, that include children from 12 months, to elementary school.

In the Republic of Macedonia in 2008, with the amendment of the Law on Primary Education, nine-year education was introduced, so children aged six to seven from preschool institutions were transferred to primary schools (***, 2009a).

In addition to administrative officials and auxiliary-technical staff, the preschool institutions also employ staff who perform foster care, educational, pedagogical, psychological work, health care, etc. In the playrooms, for performing the daily activity with the children, there are *educators* who are graduated pedagogues and pedagogues for preschool education and caregivers with a four-year secondary education and a valid license for a caregiver work (***, 2009b).

2.2.2. Republic of Bulgaria – organizational set-up of preschool system

Preschool institutions in the Republic of Bulgaria (***, 2016a) are divided into two units:

A. **Nursery groups**, children from 1 to 3 years.

B. **Kindergarten groups**, organized into four age groups:

- a. *first age group*: 3 - 4 years old,
- b. *second age group*: 4 - 5 years old;
- c. *third preparatory age group*: 5 - 6 years old;
- d. *fourth preparatory age group*: 6 - 7 years old.

Staff performing teaching duties have functions related to the preparation, organization and implementation of teaching, upbringing, socialization and childcare in preschool institutions are (***, 2016b):

- a. a teacher: plans the educational process,
- b. a senior teacher: conducts the internal institutional qualification,
- c. a head teacher: assists in developing an institutional development strategy.

Educational duties in kindergartens are performed by:

- a. an educator,
- b. a senior educator,
- c. a head educator.

2.2.3. Republic of Croatia – organizational set-up of preschool system

According to State pedagogical standard (***, 2010a), in the Republic of Croatia the educational groups of children in the regular program are divided into:

A. Nursery groups

- a. age from six to 12 months, the first nursery group
- b. age from 13 to 18 months, second nursery group
- c. age from 19 to 24 months, third nursery group

B. Kindergarten groups

- a. age of 3 to 4 years, small kindergarten group
- b. age of 4 to 5 years, medium kindergarten group
- c. age of 5 to 6 years, big kindergarten group
- d. age of 6 to 7 years (before starting school), preschool group

In the kindergarten, the immediate tasks of upbringing and training of preschool children from the age of six months until their departure to primary school are performed by the educators.

2.2.4. Statistic data for preschool children

According to the statistical projections of the State Agency for Statistics of the Republic of Macedonia (***, 2018b) in 2017 there were 35,286 children covered by some of the forms of preschool education. In Skopje, the number of children attending preschool is 16,086, or almost half of the total number in the entire country. In Republic of Macedonia there is a total of 99 institutions, of which in Skopje 43 institutions.

According to the statistical projections of the State Agency for Statistics of the Republic of Bulgaria (***, 2019a) for the school year 2018/19, there are 218,767 children covered by some of the forms of preschool education. In Sofia, the number of children attending preschool is 44,948. In Republic of Bulgaria there is a total of 1,834 preschool facilities and 276 facilities in Sofia.

According to the statistical projections of the State Agency for Statistics of the Republic of Croatia (***, 2019b) for the school year 2018/19, there are 139,378 children in the country, covered by some of the forms of preschool education. In Zagreb, the number of children attending preschool is 39,953. In Republic of Croatia there is a total of 1710 facilities, and 330 facilities in Zagreb.

2.2.5. Duration of education process in the three observed countries

Preschool institutions, according to the duration, carry out programs for (***, 2010a; ***, 2013):

1. All-day stay, where children stay from 8 to 11 hours a day. This form of stay has an educational and caring character, especially for those children whose parents are employed.
2. Half-day stay, lasting from 4 to 6 hours a day, in which, unlike the classic all-day stay, children stay according to the needs of the parent or the affinity of the child.
3. Shortened programs that last from 240 to 600 hours per year, i.e. a stay of children for a few hours, two or three times a week, which has the role of socialization or education of the children.

The way of organizing the daily stay in the preschool institutions influences the definition of the space where the children stay. The activities that the children perform, depending on the time they are present in the playroom, do not depend only on its dimensions but on the functional organization as well, so the longer they stay, the more functions they perform. The space is arranged according to the needs of the children who perform them, but it also depends on the length of stay (***, 2013).

2.3. EUROPEAN STANDARD FOR FURNITURE IN PRESCHOOL INSTITUTIONS

The standard EN 1729-1:2015 (***, 2015b) is a European standard, adopted by the European Committee for Standardization (CEN) in which all the countries of the European Union, and some European countries that are not part of the Union, are members.

In all three countries where the research has been carried out, the same national standard, based on EN 1729-1:2015 applies: HRN EN 1729-1:2016, MKC EN 1729-1:2016, БДС EN 1729-1:2016. So far, that standard is the best regulation describing the functional dimensions of chairs and tables for preschool and school facilities and prescribing safety requirements and test methods. This standard is consisting of Part 1 and Part 2. The standard refers to chairs and tables for educational institutions, and its Part 1 for functional dimensions, in which, depending on the height of the children, a division is made, marked from 0 to 7. The height for preschool children enters in the size mark from 0 to 3 (Table 1).

2. THEORETICAL BASIS AND ANALYSIS OF THE ISSUE

Table 1 Size marks for chairs and tables according to European standard EN 1729-1:2015

Size mark (all measures in mm)	0	1	2	3
Color code	white	orange	violet	yellow
Popliteal range	200-250	250-280	280-315	315-355
Stature range	800-950	930-1160	1080-1210	1190-1420
h8 height of seat ± 10	210	260	310	350
b3 desk width (min)	210	240	280	320

2.4. THE ROLE OF ANTHROPOMETRY IN KINDERGARDENS

Anthropometry is a term denoting measurement of a person and derives from the Greek words, antropos - man and metrien - measurement (Sherilova, 2009). It is a study that is part of physical or somatic (biological) anthropology⁴, in which measurements are made of parts of the human body (Trojchanec, 1981; Gjorgoski and Dashtevski, 2004).

Many authors define antropomerty differently. According to Bridger (2003), anthropometric data are used in ergonomics to specify the physical dimensions of workspaces, equipment, furniture, and clothing to ensure that physical disparities between the dimension of equipment and products and corresponding user dimensions are avoided. Ergonomics uses anthropometric data to make the best shape and dimensions of machines, tools, devices, products, and work environment adapted to the anthropometric properties of humans (Mikšić, 1997). According to Mijović (2008), anthropometry is a biological study of the measurement of the body. The anthropometric data provide information on the distribution of the measures of the human population.

In the manufacturing of products, machines, tools etc, that will be in line with the individual needs of everyone who uses them, we are facing a big problem. A chair or workplace separately for each individual cannot be made. That is why anthropometry takes its place and using its methods come up to an average that would fit the majority of people in a population using the product. Anthropometry provides quantitative data to match the physical with the body dimensions when using the workplaces. It is also used in the design for the manufacturing of various products. Designers and engineers need to know the anthropometric measures well, their application providing a product, a workplace, a machine that fully meets the needs of man.

⁴ Physical anthropology deals with the theory of evolution, with systematization, changes that occur in the human organism, the issue of growth and development (physical, psychological and gender related) under the influence of environmental factors (Gjorgoski and Dashtevski, 2004)

Depending on what is measured, anthropometry is divided into (Gjorgoski and Dashtevski, 2004; Nacheva et al., 2012):

- Somatometry, measurement of the human body;
- Osteometry, measurement of the skeleton,
- Cephalometry, measurement of the head.

Measurement takes place from one anthropometric point to another and is called metric measurement or measurement of angles created from certain planes and lines, gonometric measurement. Anthropometric points are located at a precisely determined place on the body. Depending on the location, they are divided into fixed and variable (virtual) anthropometric points. The fixed ones are located on the same part of the body, while virtual points change in terms of changing the position of the body. Traditionally, measures are taken in the metric system. For standardized measurements, the body is placed in an upright standing or sitting position (Salvendy, 1997; Gjorgoski and Dashtevski, 2004; Nacheva, et al., 2012; Pheasant, 2003). (Figure 8).

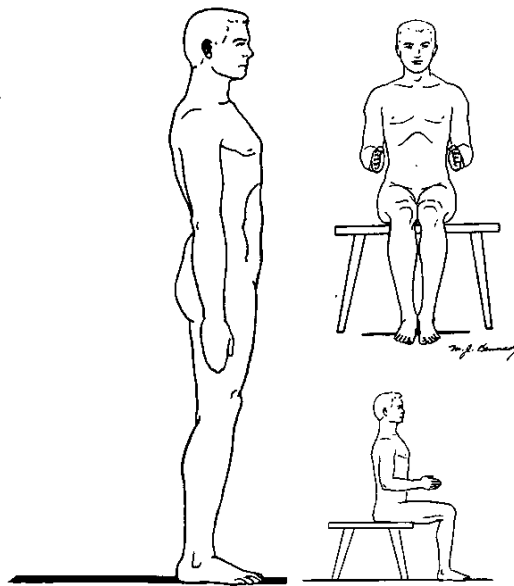


Figure 8 Typical posture used in anthropometric data gathering.
Source: Salvendy, 1997.

There are two types of anthropometric measurements (Muftić et al., 2001; Mikšić, 1997):

- Static or structural anthropometry when a person is measured in a fixed position. Measurement is clearly performed from one anthropometric point to another.
- Dynamic or functional anthropometry, the measures are taken when a person moves in relation to one reference point.

2.4.1. Factors impacting anthropometric data

When taking anthropometric data, it is first necessary to know which target group will be measured, i.e., at what population is the product aimed. The measures depend on many factors: genetic, climatic, socio-economic, gender, age, etc. (Maver et al., 1976; Salvendy, 1997). Anthropometric measures directly depend on genetic factors – genotype and non-genetic factors – phenotype (Maver et al., 1976).

The mutual correlation leads to the acceleration or deceleration of a certain anthropometric component. The phenotype is a direct product that acts on the genotype, i.e., it is a direct product that impacts this interaction. How much a genotype will develop depends also on the external influences, i.e., how much a population lives under different natural and social conditions. Phenotypic variations of one population are the sum of genotypic variations associated with each other as a 'total stock of genes' and that part of the environmental variables that directly affect the phenotype. (Maver et al., 1976; Mikšić, 1997). It can also be shown by the formula $F_v = E_v + G_v$, in which F_v is a phenotypic variation; E_v is a variation of environmental factors and G_v variation of the genotype. Genotypic variations in human population are the result of the adaptation to numerous environmental influences (Maver et al., 1976).

Anthropometric data, depending on the impact of environmental factors, can be divided into meso-stable variables, in which external factors do not greatly affect, such as the height of the human body, height in a sitting position, etc, and meso-labile in which the genetic factor is not decisive, but are conditioned by environmental factors. This includes body weight, body, and limbs dimensions, etc. (Maver et al., 1976).

2.4.2. Anthropometry of preschool children

Complete anthropometric data for children, especially for those of preschool age, are shamefully less frequently found in specialized literature than those for the adult person. Human measures, and therefore those of children, belong to a group of certain anthropometric data of one population. In existing and available literature, the anthropometry for adults of both sexes is relatively better treated than child anthropometry that is almost nonexistent (Muftić, 2001; Muftić, 2005).

Knowing the anthropometric data of children's age is of great importance when making products that are used by them. Through precisely determined measures, clothes, toys,

equipment of rooms used by children are produced. Moreover, through the knowledge of anthropometry, the physical development of each young generation can be determined, which is an essential indicator of the health situation of each nation and together with this also reflect the social and economic and hygienic conditions of each society (Zhicheva, 2007).

2.4.3. Periodization of the development of the child

In human ontogeny, two stages are distinguished: Prenatal period⁵ and postnatal period⁶ (Zhicheva, 2007). The postnatal period is divided into several age periods. Many authors divide the periodization into different schemes both from biological aspect and from social one, which affects growth and development and psychological conditions. A widely popular division used in anthropology, pediatrics, psychology of the postnatal period was taken from the VII All-Union Conference held in Moscow in 1965, which covers the problems of adult periodization from morphological, physiological, and biochemical aspects (Zhicheva, 2007). This division includes the regulations in the formation of the organism and the person, as well as the social factors, including those associated with the child's training. The scheme is (Zhicheva, 2007):

- Newborn 1-10 days,
- Infant 10 days-1 year,
- Early childhood 1-3 years,
- First childhood 4-7 years,
- Second childhood 8-12 years,
-

In the Republic of Croatia, according to pedagogical practice, a different division of the developmental period of children is used (Prebeg and Prebeg, 1985):

- Intrauterine period
- Early childhood: infant - from birth to 11 months and nursery period from 1 to 2 years.
- Preschool period from 3 to 5 years,
- School period from 6 to 18 years.

⁵ Prenatal period is the period of development of the fetus in the womb, the pre-birth development.

⁶ The postnatal period is the period after birth. In the postnatal period, the individual development of each individual from his birth to death is realized.

The divisions of the childhood period should not be taken so rigidly and restrictively. Development is a continuous process and the child gradually passes from one period to another, faster or slower, following its own individual pace of development (Prebeg and Prebeg, 1985).

According to Anglo-Saxon authors (Lueder and Berg, 2008), the childhood period differs according to:

- Intrauterine period,
- Infant – from birth to 11 months,
- Period of small child – from 12 to 23 months,
- Preschool age – from 2 to 5 years,
- Early school age – from 6 to 12 years,
-

In the preschool institutions in the Republic of Croatia, but also in the entire Balkan region, children in the educational process are divided into two units: *Nursery* groups from 9 months to 3 years and a group of *kindergartens* that covers children from 3 years to 6 or 7 years (***, 2010a). In the UK and USA preschool age covers children up to 5 years old, in Denmark and Sweden from the 3 to the 5 year, and in Germany and Austria to the 7. In other European countries it is up to the 6 year (Lueder and Berg Rice, 2008).

2.4.4. Physical growth and development of children

2.4.4.1. Characteristics of physical child's growth and development

Physical growth and development mean the rise in height and weight⁷, a change in the body's proportions, anatomical, histological, and functional development of the organs and organic systems. Intensive growth is not equal throughout the entire developmental period. Growth is greatest in the first year when the body grows an average of 23-24 cm, and the weight increases by about 7 kg. In the second year, the growth decreases, the child grows on average about 7-8 cm and in weight increases 3 kg. From age 4 to 5 years, children grow at a fairly stable pace, that is, the rate of growth of the body gradually decreases. In the process of growth and development from birth to mature person, body weight increases by 20 times (Prebeg and Prebeg, 1985; Šercer et al., 1986; Delpuch, et. al., 1999; Zhicheva, 2007)

⁷ In the anthropometry in the second half of the 20th century there emerged a new science of human auxology (from Greek auxono- growth). Auxology deals with the growth and development of the body in terms of height and weight.

During human development, parts of the body and certain organs alter their ratio. The outer form of the body and its proportion change. The proportions between the size of the trunk and the size of the head are particularly changing (Šercer et al., 1986) (Figure 9).

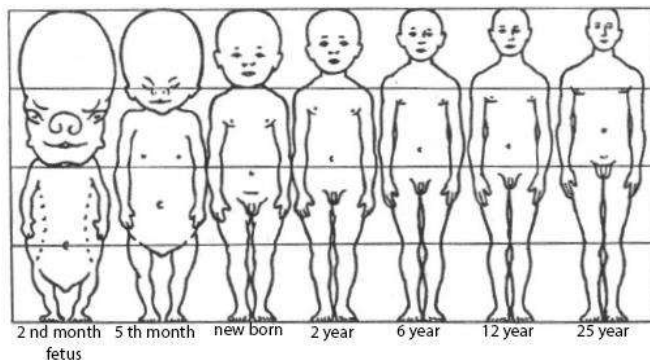


Figure 9 Proportion of the head of a newborn and grown man.

Source: Mučić, 2005

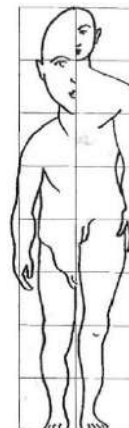


Figure 10 Change in the proportion of the body from the fetal month to the end of adolescent age.

Source: Šercer, et al., 1986

The head of the newborn is a quarter of the total height, while in an adult the head is one-eighth (Figure 10). The increase in the size of the head from the newborn to the achievement of maturity is very small. The ratio of the size of the head compared to the height of the man is given by the canon in which the head is eight times contained in the height of the man. The same can be determined in children, with the difference that for each age the canon is different (Table 2) (Mučić, 2005). According to the existing data, it is established that the change of the canon is also related to the harmonious change in the size of particular parts of the body.

Table 2 Canons in children.

Title	Newborn	One-year old	Four-year old
Canon used	4 Head Lengths (HL)	4-4,5 HL	5,5 HL
Trunk	1,66 HL	1,75 HL	1,80 HL
Arms	1,50 HL	1,75 HL	2,25 HL
Legs	1,33 HL	1,75 HL	2,50 HL

Source: Mučić, 2005

According to the construction of the body, children are divided into three types (somatotypes): endomorphic type, mesomorphic and ectomorphic type⁸ (Nacheva, et al. 2012). It is very rare to find a pure body type. They are usually a combination of all three types. Depending on the different combinations of dominance of the somatotrophic units of the three components, 13 somatotypes and one central somatotype are formed. That is why children are so much different in terms of body structure. They can be both tall and short regardless of the somatotype they belong to. Endomorphs usually mature early, and the ectomorphic later, therefore in puberty, endomorphs appear tall and the ectomorphic short (Šerčer, 1986).

2.4.4.2. Factors affecting children's anthropometric data

Every child has the ability to grow and develop (Bralić, 2008). It is made possible by the very nature in which everything is born, developed, and grows. However, how the process of growth will depend on many factors, some impact it positively, some negatively, which is explained below.

- *Genetic or hereditary factor*

The most important factor that determines the development of the child are the genetic predispositions inherited from both parents. The growth process is determined by a complex neuro-endocrine mechanism in which the action of various external influences can lead to a change in its activity (Bralić, 2008). The genetic predisposition in each person individually can be activated or frozen at some point depending on the factors that affect the body.

To see how much the degree of genetic determinant influences the development of the child, studies have been made on twins and on family genes. In the case of monozygotic twins that represent a natural genetic experiment, the genetic predisposition impacts much more than the external influence on the organism. Same in the case of dizygotic twins that differ genetically, the genetic factor has a greater impact than the external factor. In assessing the impact on the shape and size of the body it has been established that children have the same shape as their parents (Dundova, 1978; Zhecheva, 2007).

⁸ Endomorphic type - rounded body, rather large digestive organs, well developed fatty tissue, large trunk and thighs, thin limbs; Mesomorphic type – quadrilateral body type, strong body built, well-developed muscles, bones and connective tissue; Ectomorphenic - type, linear and fragile body, poorly developed fatty tissue, gentle muscles.

- *Difference between the sexes*

Even at first glance you can see the difference between the two sexes (Muftić, 2005). This difference is called gender dimorphism⁹.

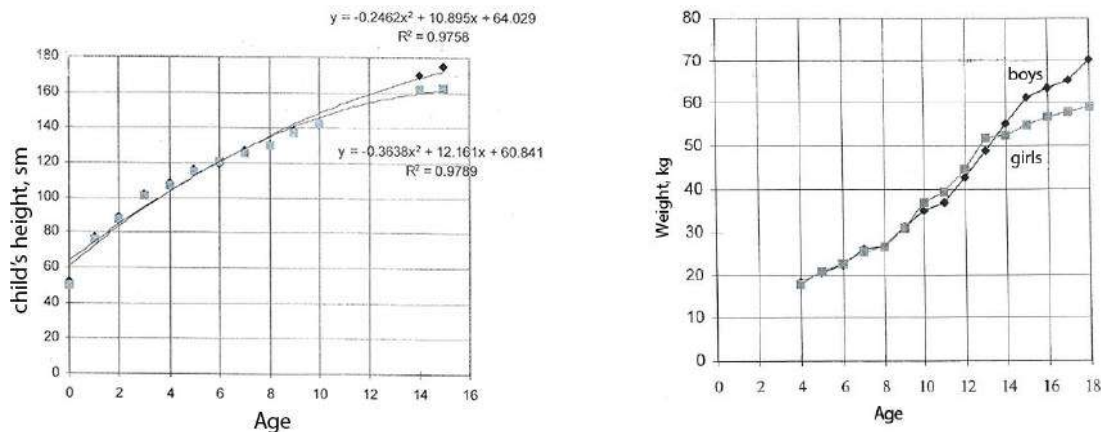


Figure 11 Height (lefr) and weight (rigrh) curves between boys and girls.

Source: Muftić, 2005

The age of 1 to 7 years is called neutral childhood. During this period, the size and shape of the body differs very little between boys and girls. This can also be seen graphically (Figure 11), where from age 2 to 8 years there are no visible differences. Statistical differences between the mean height in boys and girls occur after the age of 10, that is, at the time when the puberty hits, the differences are most conspicuous. The same is true of body weight (Zhecheva, 2007; Muftić, 2001; Muftić, 2005). There are many authors in literature (Prebeg and Prebeg; 1985; Šercer et al., 1986; Ray, et. al., 1995; Muftić, 2001; Muftić, 2005; Zhecheva, 2007; Bralić, 2008;) who note that there is a difference in the physical development between the sexes. It has been found that girls in the first 4 to 6 weeks are more developed than boys, just like puberty that occurs 2 years earlier than for boys. Moreover, girls reach 50% growth in 1.75 year, while for boys this it occurs after the second year. Following inter-gender differences, it has been established that boys have an advantage over girls in terms of length of the trunk and upper limbs as early as one month old. Up to 1.5-year-old, the height in a sitting position and the width of the shoulders is greater in male children, while the bispial diameter is greater in female ones. Boys have longer lower limbs up to the fourth year, the head and face, i.e., all the measures are bigger, with the difference that after the fifth-year girls have bigger lower limbs. Regardless of the fact that gender differences in the period prior to puberty are very small, some statistical significance can be achieved in some anthropometric data (Prebeg and Prebeg; 1985; Šercer et al., 1986; Muftić, 2001; Muftić, 2005; Zhecheva, 2007; Bralić, 2008).

⁹ biological differences in appearance between the males and females of a species.

- *Natural - environmental factors*

The anthropometric data of children are of great variable potential. The population from different climatic and geographical areas differ among themselves in terms of size and shape of the body, as well as the rate of growth. In temperate and cold areas children are usually of bigger growth. In spring and summer children grow faster, but on the other hand, they are thinner. In autumn and winter, they grow more slowly and gain more weight. In the warmer regions, children develop faster, unlike in colder ones, provided the socio-economic conditions are the same in both (Prebeg and Prebeg, 1985; Šercer, 1986).

Anatomical difference does not occur only between individuals, but also among large human groups, called ethnic groups and races. In a study that explores different ethnic groups in the Tumen region, children of the Khanty between 3 and 7 years old are with relatively smaller growth than Russian children living in the same area (Zhecheva, 2007). In the USA, which are composed of many ethnic groups, research has been done, which concluded that difference in the height of preschool children is present (Anderson and Whitaker, 2009). Some ethnic groups have similarities between themselves, while others display great differences. The differences between the black and white race living in the United States are not as great as the difference that occurs within the same race that lives in two different areas (Salvendy, 1997).

Children living at higher altitudes are shorter and weigh less, and their development is slower. Children living in the Andes have been found to be shorter and leaner than children living at lower altitudes (Zhecheva, 2007). Another study by Al 'Shehry (cited in Zhecheva, 2007) made up of 13,580 children living at altitudes above 3,100m, found them to be below the American standard in terms of height and weight.

Other factors that affect children's growth are air pollution, gradual increase in temperature, extreme natural disasters that are more frequent in recent years (Pop-Jordanova and Grigorova, 2015)

Shorter growth and lower weight are not always the result of adverse effects and do not reflect a disturbed physical development and are due to ethnic and climatic differences (Eiben, 1988).

- *Socio-economic factors*

Children who live in different socio-economic conditions are developing in a different somatic way (Prebeg and Prebeg, 1985). Children in good conditions are on average more developed than children living in worse conditions. One of the key factors is nutrition, which with low economic standard is always insufficient. In the Satyanarayana study 1980 (cited in Zhecheva, 2007), it was noted that 20% of the boys with the shortest growth were in a severe form of starvation in their early childhood. The authors conclude that this result could have been avoided if measurements were taken of boys at the age of 5 (Zhecheva, 2007). Besides this, poverty is accompanied with poor housing, unhygienic conditions, illness without proper care, fatigue, lack of sleep, stress, as well as other factors that can negatively affect the child's development. (Prebeg and Prebeg 1985). Analyzing the Mascie-Taylor and Lasker data 2005 (cited in Zhecheva, 2007), children who grow up in better living standards are at a certain age more developed and mature than their peers who grow up in bad social conditions. According to the same authors, a national survey in Hungary found that children from more numerous families are shorter and leaner, unlike those from families with fewer members (Prebeg and Prebeg 1985). Moreover, the development of children is affected by the parents' age, the profession of the mother, i.e., the level of education and the economic level of the household. (Zhecheva, 2007; Delpuch, 1999 (cited in Zhecheva, 2007)). Children born in an urban environment are taller than children who grow up in villages. But in countries with a highly developed economy in which there is almost no difference between urban and rural areas, the growth difference is almost no-existent (Eiben, 1988).

2.4.4.3. *Secular trend in the process of growth and development of children*

Acceleration¹⁰ or secular trend is the appearance of an increase in height and weight, both for children and adults (Zhecheva, 2007). In Anglo-Saxon literature this phenomenon is called a secular trend (Bralić, 2008). The data from comparatively many studies of different generations of children show that since the 19th century, when this phenomenon began to be monitored, growth acceleration, body enlargement, and earlier maturation are in a constant rise (Zhecheva, 2007). From the Neolithic Age to the 19th century, human race is becoming increasingly taller, with the trend of accelerating growth most evident during the twenties of

¹⁰ Comes from the Latin word *Acceleratio* – acceleration. For the first time, this term was used by the German physician Koch in 1935 year.

the last century. The question arises whether this phenomenon reflects the "microevolution" of genetic change or reflects lifestyle changes and the improvement of social and economic conditions (Bralić, 2008). According to the same author, secular changes can be both variable and reversible (positive or negative) depending on gender, age, race, economic and social circumstances, etc. (Prebeg, et. al., 1994; Bralić, 2008; Domljan, 2011).

Secular changes in growth are conditioned by two factors: by the biological laws of man, i.e., the genetic predisposition and the influence of the natural - geographic and socio - economic conditions of life (Zhecheva, 2007).

The secular changes in the growth and development of children in the preschool period historically have the greatest increase in the 20th century. In North America and Europe from 1890 to 1950, children from the fifth to the seventh year, are on average are 1 to 2 cm taller and about half a kilogram heavier every decade (Prebeg and Prebeg, 1985). According to Jaeger (1998), the weight and height of preschool children has been rising significantly from the beginning of the 20th century to 1996. Vercauteren et al. 1996 (cited in Zhecheva, 2007) writes about the positive secular trend of children in Belgium in the period from 1930 to 1982, of which the most significant increase was observed in children from the age of 3 to 4 years, in the size of the head. In the Czech Republic according Vignerova & Blaha 1998 (cited in Zhecheva, 2007) between 1951-1991, the median length of the body of children aged 1 year increased by 3 cm in boys and 2 cm in girls. Many authors prove this positive secular trend of children's development (cited in Zhecheva, 2007).

With the stepping into the 21st century many studies done in this area indicate a slowdown and stabilization of the acceleration of children's development. Some authors even point to deceleration in development and sexual maturation, emphasizing that a period of negative secular trend will follow. According to Bodzsár and Sussane 1998 (cited in Zhecheva, 2007), the biggest acceleration changes in the development of children's growth in Europe were observed in the 70s and 80s of the 20th century. After this period, things come to a stop, even to a point of deceleration in the physical development of children (Zhecheva, 2007).

However, after all the provided data on secular changes in children, it can be said with certainty that man has not yet reached his genetic potential for growth, and further development of secular changes in different directions and intensity can be expected (Prebeg and Prebeg, 1985; Prebeg, et. al., 1995; Jaeger, 1998; Zhicheva, 2007; Bralić, 2008).

2.4.5 Importance of anthropometric data in the designing of preschool furniture

As an essential and indispensable prerequisite for the design and production of furniture, besides the safety, functionality, use of materials, durability, comfort of the furniture, is the knowledge and the use of anthropometry. Studying the needs of preschool children related most directly to their growth and development reflects on designing furniture that corresponds to their age and dimensions (Prebeg, 1997; Živičnjak et al., 2003; Kroemer et al., 2003; Molenbroek et al., 2003; Dostoglu Turkun, and Şahin, 2012;).

Anthropometry facilitates information about the physical characteristics of children, which are of great importance to designers and manufacturers of children's products. By applying the appropriate data, the product design can be adjusted to the majority of the population (Prebeg, 1997; Živičnjak et al., 2003; Kroemer et al., 2003; Molenbroek et al., 2003).

Proper product design for children is conditioned by accurate body data. Consideration should also be given to the large differences in body dimensions in children of the same age, hence the design of furniture suitable for this whole population is very difficult. This means that using age categories for design purposes (in years, or in months for very young children) will probably misrepresent the valid data. The large variations among children of the same age make it more difficult to design for children than for adults. Designers of children's products must account for such a key stage in child development and important developmental factors (Figure 12), (Lueder, and Berg, 2008; web 7).

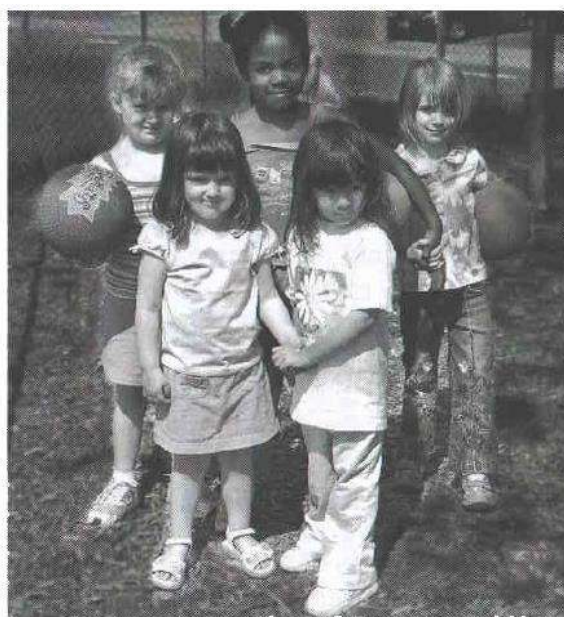


Figure 12 Child anthropometry between children of the same age
Source: Lueder and Berg, 2008

The great difference in the growth of children even at the same age, as well as their fast and rapid growth, is a great challenge in designing furniture. Differences in child development can sometimes lead to overlapping of anthropometric data for different ages. For example, a 4-year-old child may be taller than the shortest 6-year-old child. These differences between children from different age groups lead to the design of children's furniture according to their development, and not according to the age group they belong to. The anthropometric differences between the sexes of preschool children are not so great that they can be considered for each sex separately (Lueder and Berg, 2008).

With serial furniture production it is impossible to know all the specific characteristics of each individual future user. Hence, an arbitrary sample should be measured of the users for which the product is intended, in order to be able to evaluate the data. For this reason, furniture of different sizes should be manufactured or be adaptable with various mechanisms (Voigt and Greil, 2009; Domljan, 2011).

Obtaining mass anthropometric data, even in the most developed countries, is hardly feasible. Large-scale anthropometry surveys are very expensive, time-consuming, and difficult to perform (Salvendy, 1997). Anthropometric measurements of pre-school children are carried out in almost all countries once a year at systematic examinations, where height and weight are measured (Prebeg and Prebeg, 1985).

When designing preschool furniture, many countries use anthropometric data that is very old (Norris and Wilson 1995). All this leads to the irregular size of the furniture used. Another element that indicates lack of sufficient anthropometric data is the small number of conducted expert studies. The same view is shared by Panero and Zelnik (1990) who point out that “the designers are given very little data on the dimensions of the child's body”. In some studies, there are some data missing that are very important for furniture design, while in others, the number of respondents participating in the study is too small to be generalized for each nation separately (web 7).

In all anthropometric research, as well as in the collection of data on anthropometry used for furniture design, particular protocols are observed, especially concerning the design of seating elements. Measures should be made by well-trained people and the same should participate in each measurement session. Measures should be taken with the same anthropometric devices (web 8). When taking measures in a sitting position, a cubic chair with a adjustable footrest and backrest is used. Children should be seated at angles between body parts of 90° (Figure 13). An example of anthropometric data to be taken in measurements for

the furniture design needs is shown in (Figure 14). There are authors who point out the fact that in everyday conditions in schools, kindergartens and at home, children do not stand and sit constantly in standard positions in a natural way. Therefore, the dimensions taken from the measured poses should be changed so that they reflect the actual position of body posture. The positions occupied by the body are many, so every designer needs to know exactly what he requires and what element needs to create (web 8).



Figure 13 Cubic seat with adjustable footrest.

Source: web 8

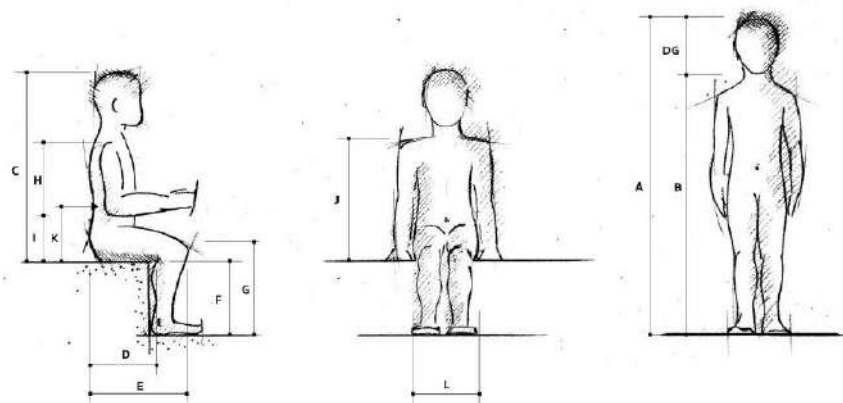


Figure 14 Measuring anthropometric variables

Source: Domljan, 2011

Table 3 Measuring anthropometric variables and their marks. Source: Domljan, 2011.

A	Stature
M	Weight
DG	head height
B	stature up to head height
C	sitting height
D	upper leg length, buttock–popliteal length, seated
E	upper leg length, buttock to knee, seated
F	popliteal height, seated
G	knee height, seated
H	upper arm length, shoulder to elbow
I	elbow height, seated
J	shoulder height, seated
K	lumbar height
L	hip breadth, maximum when seated

2.4.5.1. Inconsistency between children's body dimensions and educational furniture

Due to old furniture based on outdated anthropometric data, as well as due to lack of new data, the inconsistency between children's anthropometric data and the dimensions of furniture, there is almost no country that does not face the same problem, specially in schools (Evans et al., 1992; Paracells et al., 1999; Hänninen and Koskelo, 2003; Legg et al., 2003; Diep, 2003, Domljan, and Grbac, 2003; Panagiotopoulou et al., 2004; Önder et al., 2006; Voigt and Greil, 2009; Iliev, 2011; Domljan, 2011; Domljan et al., 2015).

Numerous authors (Prebeg i Prebeg, 1985; Watson et al., 2003; Burton, 2005; Trevelyan and Legg, 2006; Iliev and Domljan, 2016; Iliev and Domljan, 2017; Iliev, et. al., 2018) point to the problem that occurs when sitting on inadequate pieces of furniture which is the main cause of poor posture and curvature of the back (kyphosis and scoliosis). Moreover, same authors confirm that the inconsistency between anthropometric data with the functional dimensions of the furniture is the main cause of back, neck, head and leg pains.

In the literature, the data related to the mismatch of anthropometric variables with the dimensions of furniture for children of school age are in greater numbers in contrast to the data for preschool children (Önder et al., 2006; Voigt and Greil, 2009; Iliev, 2011). Such a study that confirms mismatch of anthropometric variables with the dimensions of furniture has been done by Önder et al. during 2001 and 2002 in Turkey, which included 288 preschool children. 18 anthropometric variables had been measured. Also measured were types of furniture such as chairs, tables, coathanger, washbasin, mirror WC pan and TV table. A comparison of each

furniture variable has been made. The results suggest that in the case of all pieces of furniture that are subject to research at least one of the dimensions does not correspond with the anthropometric data of children. For example, the tables are 'very problematic' in depth, and 'problematic' in width. The chairs are 'problematic' in depth and height (Önder et al., 2006).

Research by Andrea Voigt and Holle Greil (2009), done in Potsdam, Germany, on 122 children aged 3 to 7 years in three kindergartens, suggests that knowing the appropriate anthropometric data helps obtain elements of furniture that are fully functional for children. Six anthropometric variables were taken (sitting height, leg length, elbow height over seat, lower leg length etc.). This study points out that the detailed knowledge of seated body relevant measurements is necessary for the construction of optimal adapted chairs and desks. An optional chair is marked by the facility to arrange both feet completely on the floor. In this position, the compression on the back of the thighs with their blood vessels and nerves is minimized. For the evolution of optimum height boards, the knowledge of the height of the seat and the elbow height above the seat is essential (Voigt and Greil, 2009).

Iliev (2011) has conducted research in Skopje, Macedonia on 80 children aged 2 to 6 years, measuring 13 anthropometric variables and comparing them with the dimensions of existing tables and chairs. According to the obtained data from the measurements of the chairs and tables in the facilities, it can be concluded that: The children from the first small group can not use the existing chairs and tables, because they are higher. Children from the second small and middle group can use the smaller-sized chairs. Children from the big group can use larger-sized chairs, by reducing the height of the sea (Iliev, 2011; Iliev. and Karanakov, 2013).

2.5. PSYCHOLOGICAL AND PEDAGOGICAL ASPECTS AFFECTING FURNITURE AND INTERIORS IN KINDERGARTENS

The child from an early age can be vulnerable, i.e. the bad atmosphere in the family or the institution and the inappropriate actions that affect his/her development and learning can cause a number of psychomotor diseases (Kamenov, 1988). The environment, that is, the interior in which they stay, acts in the same way. Improperly used color and to the greatest extent inappropriately designed furniture directly affects the improper psychophysical development of preschool children. Although not enough attention is paid to what the furniture should look like, it is a crucial element for the appearance of the interior (the surrounding). Improperly designed furniture, both in kindergartens and schools, contributes to improper

maintenance of educational activities, body aches, loss of concentration, but also a feeling of discomfort in the space in which children stay, as well as affecting the safety and security of children, with the possibility of physical injury (Lazarov, 1975; Nikolova, 1986; Belamarić, 1987; Podđakov, 1992; Grozev and Tiholov, 1993; Valkov, 2001; Auf-Franić et. al., 2003; Velkov, 2005; Stoecklin, 2007; Domljan, 2011; Fischil, 2011; Wardle, 2011; Wiser, 2011).

Initially, kindergartens were designed and oriented in the traditional way of education and learning. In the classical preschool institution, the main initiative belonged to the "managerial" role of the educator. However, thanks to the great development potentials in early childhood, today preschool children are no longer seen as beings with habits and memory, but as beings who are able to examine, analyze, see differences, discover similarities, and so on (Cohen and Stern, 1974; Dudek, 2008; Şahin and Turkun Dostoglu, 2012; Vassiliki and Aimilia, 2012). Thus, over time, as the attitude towards the child and his pedagogical and psychological needs changed, so did the concept of the interior.

The space and the way it is organized can significantly help or hinder education. The interior and exterior space created for children must offer them a chance to gain individual life experiences. Spaces are not merely "expanses of emptiness", but may make a considerable contribution towards a child's successful early life.

The task of each teacher is to enable (with the organization of space and work) occasional isolation and individual play. A child who has the conditions for independent play, who can occasionally be left alone, with any activity that he / she performs independently, will be more easily involved, or activated in the group activity or to participate in organizing a joint game. The activity of the child in a large group is possible at most 6.11% of the time, according to the explanation of prof. Miljak (Miljak, cit. in Stevanović, 2001). As for individual children's activities, motor activities are the most represented (16.4% of the time is for independent coping with some activities), and for symbolic ones (is 14.65% of the time), (Miljak, cit. in Stevanović, 2001). Thus, the space should be organized depending on the type of activities that the children perform during their stay in the kindergartens.

There can be noticed a big difference in the behaviour and the way children of different ages play (Stanković, 2009). The distinction is present even in the relatively close age groups of children, such as children aged 3, 4 and 5, and hence the need to differentiate children in relation to the organization of the space in which they stay, through the formation of certain units (zones) intended for play and other activities. Thus, children from 3 years of age have the best social activity in a group of 2 to 3 children, so there are several small, partially separated

units (zones), dimensioned for this number of children. Zone can be from various contents, like zone for quiet activities like reading, zone for construction, zone for fine arts and so on. Children aged 5 years can play in larger groups of up to five children at the same time and for a longer period of time, so hence the space is organized with separate units that are larger than the previous ones (Stanković, 2009). You can minimize conflicts and maximize playtime by using the classroom layout to offer options for all kinds of play: alone, with friends (groups of 2 to 5 children usually work best), or with a teacher (Fiechtner and Albrecht, 2015).

The needs of preschool children, during the development of cognitive processes in their development, when it comes to the architectural space in preschool facilities in which they stay, are largely related to children's activity, thinking and ability development. In this context, the space, or parts of the space in which certain activities take place are conceived and designed with architectural procedures. The game as a dominant activity of the children seeks its physical determination and differentiation in space in the form of indications for separation from other spaces or whole. The development of thinking in the development of children's abilities determines the space with specific structures, complex enough and inspiring for their engagement (Stanković, 2009).

„Everything is very much pre-determined by the zones or territories which are strictly imposed upon children. Although they are usually described as 'homebase' areas, many are similar in character to school classrooms. Each homebase area may be further designated into functional zones such as the cloakroom, the wet zone (with sinks for art and craft activities) and the quiet zone. This is a range of activities which is so tightly prescribed that the architecture tends to reduce and limit the scope for learning rather than extending and opening it up. The focus is on adult needs, such as safety and security, rather than on child needs, such as the promotion of exploration and discovery. Clearly this approach can obscure the potential for creativity and imagination“ (Dudek, 2007).

All the activities of the children in the nursery groups do not belong only to the game, other activities are organized here, such as observation of work activities and behavior of adults, animals, plants, getting to know the environment in which they are (Stevanović, 2001). It can be emphasized that the basic conditions for the children's work activities are the space, toys, and other didactic objects. In the rooms where children from 1 to 2 years stay, the arrangement of the furniture should not be moved (it should always be in the same position), due to the feeling of security and "children's conservatism". The playrooms should have fresh flowers and greenery. Their photographs and drawings should be hanging on the walls (Stevanović,

2001). In the third year of life, in the nursery groups, the same needs rule as those for the children from two years. The whole activity is individualized and is based on the children's needs and their unhindered prephysical development in the educational process. Good social communication between the children is also an important and indispensable condition for the proper functioning of the groups. The work of the playrooms is expanding to other areas in the kindergarten (Stevanović, 2001).

The most exciting development in the preschool period takes place in the sphere of emotions. Children experience reality around them more suggestively than they interpret it rationally. Therefore, space and furniture should evoke positive emotions, joy, satisfaction, and acceptance, so that they perceive the kindergarten as their own space and identify with it (Nikolovska, 2002; Dudek, 2008; Stanković, 2009).

It is evident that a playroom environment which helps children feel welcome, safe, and secure is critical to supporting ongoing emotional and social development. Children must primarily feel that their basic needs for safety, love, and belonging are met before they can take charge of their learning. The most basic level of need is confidence that physical needs will be met promptly and sensitively. Once that basic level is met, children must feel emotionally safe and supported. Finally, children need to have the feeling of belonging – they need to feel welcomed and cherished. Only then learning is possible (Fiechtner and Albrecht, 2015).

However, it must be a conscious architectural exercise when designing a kindergarten in order to meet the spatial needs of the individual child as well as those of the whole group (Dudek, 2000).

A kindergarten should be designed to encourage the development of a child's cognitive, social, emotional and motor skills (Colbert, 2006; Stoecklin, 2007; Fiechtner and Albrecht, 2015). Particularly as childhood is often repressed in many sections of society today, children should be given the chance to mess about and play: e.g. to hammer, saw, build, experiment, splash around, climb, run, tussle, hide, slide, dig etc. (Falk, 2019; Remenschneider, 2017) Contemporary architects can do much more in applying these experiences. They have the opportunity through their positive approach to this knowledge and their application, in the construction of the preschool facilities, to give their professional contribution towards a happy childhood (Stoecklin, 2007).

In the process of creating space and furniture in the kindergartens, the concept of being imaginary has been fully accepted. Great example of children's creativity and possibility to play in imaginary space is explained in Dudek's book "Schools and Kindergarten" (Dudek, 2008).

Dudek describes a project where a dragon was created in one preschool facility. The dragon and the whole project were fully accepted by the children. Children came to the building every day with a song and joy, and even three years after the project was completed, no part of the dragon was damaged or destroyed. Dudek also writes about a preschool facility in which ITree of Dreams was created (Figure 15), which had the same positive effect on children. Its leafy roof reflects natural light deep into hitherto insufficiently lit corridors, its leaves rustle as if the tree is giggling. "The I Tree of Dreams even snores", inviting the children to share its dreams. They are able to explore and experience their world with all their senses, make new friends and chat to one another (Dudek, 2008).



Figure 15 The children romp in the flowery bowers and swings of the "Tree of Dreams".
Source: Dudek, 2008

In kindergartens, which are built as "open spaces" facilities, children learn more and have healthier social life. They would, if permitted, explore linen cupboards, climb stairs (or any type of feature which enabled this to occur), set up games in corners and niche areas, and mount stairs to access high level walkways (Dudek, 2005). Perhaps the key dimension of this was the process of listening and hearing the views of children which had largely dictated the framework of its architectural development.

A huge problem regarding the functionality and types of educational facilities is that the large number of them have not been built or reused for modern maintenance of the educational system such as "open space" kindergarten (Dudek, 2005). On the other hand, when rearranging buildings, a large number of architects arrange the space according to their vision,

without including the opinion of the teachers, and especially the opinion of the children (Dudek, 2005). The best result in architectural form of educational facilities is evident when an informed dialogue between teachers and children are established, when children are active involved in the process of decisions in shaping their interiors and parallel, their lives. The architecture has the third dimension, which creates the special children's perception of the space and the whole environment they live, play and reside in. Opposite, when the children are not involved, they don't percept their environment as their shelter or something they are involved with. „As a result, the real needs of the children for freedom and adventure in their own worlds are censored. We must somehow give this back to them“ (Dudek, 2005).

The children's opinion should be heard when creating preschool space and furniture (Dudek, 2005; Şahin and Turkun Dostoglu, 2012). Children's views should not be ignored just because of their status as “young, inexperienced people” (Dudek, 2005; Şahin and Turkun Dostoglu, 2012; Vassiliki and Aimilia, 2012). Children know very well what they really want, what is beautiful, comfortable, etc. and they need to be remarked and perceived. "This approach has developed as a multi-method model. It was important to include a range of methods to enable the children with different abilities and interests to participate. The multi-method approach also made it possible to contribute to the overall picture or "mosaic" through traditional monitoring and interview tools. Benefits have also been added for triangulation of the findings through various methodologies” (Dudek, 2005).

A positive learning environment needs to provide activities to support all aspects of growth. To do this, the playroom needs to include activity centers that offer opportunities for both hands-on, play-based learning and developmentally appropriate instruction of academic skills (Stanković, 2009; Falk, 2019). Activity centers are several small partially separated units (zones), that can be from various contents, like zone for quiet activities like reading, zone for construction, zone for fine arts and so on. Different materials needs to be available in activity centers that invite children to inquire, explore, discover, and engage with each other about ideas. Varied types of activities need to be offered throughout the day and provided in a clear and predictable schedule, supported by routines and carefully planned transitions that result in a smooth and well-managed flow of the day (Falk, 2019).

To promote children's independence, autonomy and a sense of self-efficacy, the materials housed in the centers should be available to children so that they can get what they need on their own (Colbert, 2006; Fiechtner and Albrecht, 2015; Neiza, 2017). This means that the shelves should be open and accessible for their small hands (Remenschneider, 2017).

“Playroom environments that are thoughtfully designed encourage social learning and cognitive development. There are 5 simple ways to help make playroom a secure and welcoming place for children” (Fischlil, 2011):

1. To look like a home,
2. Personalized spaces for each child, children that have a place that is “theirs” it gives them a sense of belonging.
3. Celebrate collaborations. A child who feels connected to the group – that he is making a meaningful contribution to the whole – is a happy child.
4. Mealtimes are special. We eat family-style, and I try to make mealtimes like they would be in my home.
5. Nature is a healer. It’s a known fact that exposure to nature has a calming, healing effect on people of all ages.

“When space is well-organized, with open pathways that clearly lead to activities that offer enough to do, children manage on their own. Children can move freely from one activity to another, giving the teacher an opportunity to attend to each child depending of its needs. Space that is not well-organized creates problem areas. These include dead spaces that encourage wandering and unruly behavior, and pathways that lead nowhere or interfere with play already in progress” (Colbert, 2006).



2. THEORETICAL BASIS AND ANALYSIS OF THE ISSUE



Figure 16 Modern contemporary kindergarten playroom for 12 children, 18–24 months.
Source: web 5



Figure 17 Modern contemporary kindergarten playroom for 24 children, 3–6 months.
Source: web 6

2.5.1. Colors in kindergartens

In a child's environment only partial attention is paid to color as an element of the overall furnishing of the space; standard arrangements are used to treat the interior, such as bright colors for greater space effect, warm colors to create a warmer atmosphere and so on (Kirova, 2006; Vodenova, 2017). These are just some of the clichés of full color organization in rooms, and lacking in ready-made color solutions for the children's interiors. Either the color difference is complemented by objects and furniture elements or they are already pre-selected according to the taste of the "elder". To some extent this is understandable, but not loyal to the children, who, according to a research, have had their own visual world and color-related preferences from an early age (Pisareva, 1999; Valkov, 2001; Klaren, et. al., 2003; Starmer, 2005; Kirova, 2006; ***, 2011; Vodenova, 2017;).

Children perceive color emotionally. It can be said that the child feels pleasure to the colors. Color affects the mood of adults, and even more so in children. The children come into contact with a new toy that has attracted their attention most of the time through the strength of the color and at the same time it offers pleasure and tranquility. Everything that brings them uncertainty, simulation is dismissed as "their world" (Kirova, 2006). Color and its influence make children perceive objects in this way. Preschoolers prefer bright and bold colors from the range of primary colors, slightly later than fifth year they differentiate among dark and light shades of primary and secondary colors. They love the bright colors, red, yellow, orange. Children at this age hardly react to shades and halftones. Older children have an affinity for green, blue and the mutual shades. A suitable colorful environment is one that is adapted to the specific preferences of the child in different age groups. They are largely related to the development of the eyes (as a visual organ). (Pisareva, 1999; Valkov, 2001; Kirova, 2006; Vodenova, 2017).

Color is extremely important for the environment where most of the time is spent. Children who grow up in a monochromatic environment have been shown to get tired faster, they are not well educated and not energetic, cheerful and "alive". Color is important for the good emotional and physical development of the child, for the development of their feelings, fantasies. A precise and comprehensive analysis of the use of the color in the rooms where children are staying is needed. The lack of color would make the atmosphere sterile and impersonal, and excessive use of color will result in overloaded and chaotic atmosphere (Dragostinova-Dobreva, 2013).

Research has been done by Kirova (2006), on how preschoolers respond to colors. Her research consists of three experiments involving children from 3 to 6 years. In the first experiment of children of age 3 and 4, music is played, in the first case it is cheerful, and in the second case it is slow and a bit of disharmonic music. Under that influence they have to draw a picture of their choice. They are offered 6 different colors to use. Music, more precisely the different type of music influences a child's emotional state in a certain way. The different emotional state also causes different use of color. The idea of this experiment is to provoke the child's emotions, so to express it through color. The conclusion of the first experiment indicates that when children are anxious they use one or two colors when drawing, while 3, 4 or more colors when they are cheerful. Also, when there is a sad music the drawings are to a large extent cold, filled with drama (wind, rain, storm, scary people, etc.).

The second experiment involves children of age 5. The task is a bit more complex, which is logical because children at this age are intellectually more advanced than previous groups. They are offered different colored pieces of clothing, to dress two kittens with, one happy and the other one sad. Ten different color types are given, because at this age children make a difference between different color types than at younger ages. The colors used for the happy kitten's clothing are warm and bold (pink, orange, light blue), while for the sad kitten the clothing is in darker colors, in cold varieties such as violet, brown. The cheerful kitten is colored in all colors available (colorful prevails), while in the sad kitten the clothes are monochrome. It is interesting to note that to girls the use of color is more meaningful and more logical in use, while to boys the form and visual interpretation of graphics are more essential (the direction of the lines, the place of coloring in the field). This phenomenon can also be explained physiologically, with the fact that children at the age of 5 begin their cognitive differentiation (Kirova, 2006).

The third experiment examined 6-year-old children. There is a white sheet of paper on which a room is drawn, and their task is to glue - arrange elements of furniture and various objects that are already prepared and already painted. Fifteen colors are used for this task. The aim is to note the choice of colors, the type of composition and the overall effect achieved in the interior, in order to draw conclusions about the peculiarity of the environment in which the child would feel optimally well according to their own requirements. The results show that children have their own ideas and solutions for the space, this "problem" excites them and fosters their fantasy. Unusually, with the boys the rooms are scattered and messy, they choose colors according to the purpose for which the object is intended (*sensible, practical approach*).

The girls use more a combination of colors so that colors are close or in the same range (pink-purple, yellow - green etc.) *reasonable approach* (Kirova, 2006).

The optical effect of colors is a consequence of light and darkness, which is due to the color's ability to reflect differently, according to the amount of light that falls on it. Therefore, in the presence of a large amount of light, the surfaces look different when there is no light. So for example, if the ceilings were painted in black the room would look darker, unlike when the ceiling would be white, the room would be lighter and wider. When choosing a color it should not be overlooked that two different materials with the same color do not have the same color expression. The color varies depending on the material's relief. The glossy surfaces make the material more active while the matte surfaces absorb the color. When the illumination is not directly directed at the object but at an angle, it creates shadows and the material looks darker. According to the law of color perspective, the objects which are closer to us have sharper and clearer contours. Hence the furniture, toys and other items in the middle of the playroom should feature more intense and vivid colors than the colors used on the walls. A good selection of shapes, tonality of walls, ceiling, floor and furniture should create an environment for children in which they feel comfortable, safe and confident. It would be appropriate to use fresh pastel colors in two-three colors and their shades, because too colorful is tiring. If the idea is to settle the difference between the two primary colors in a room such as the walls and the ceiling, it is enough to use white in between. The white color will reduce the contrast between them. When pure and intense colors are applied one to another, they behave bluntly, so contrasting or harmonious colors should be used. In each composition there should be one color and a pair of contrasting colors, adding the other colors to the elements themselves (Trstenjak., 1987; Pisareva, 1999; Valkov, 2001; Raychev, 2005; Starmer, 2005; Kirova, 2006; ***, 2011; Siu Michael, et. al., 2015; Vodenova, 2017;).

2.6. RESPONSIBILITY OF DESIGNERS IN DESIGNING FURNITURE IN KINDERGARTENS

The main task of the design is to change the human environment and tools, and indirectly the person himself. The man has always tried to change himself and his environment, but this has been made possible recently, thanks to science, technology and mass production. Finally, we are able to define, to group together the problems, to determine the potential goals and deliberately work on their achievement (Quarante, 1990; Dorfles, 1994; Lapaine, 1994). Hence, looking at the furniture and the overall environment in which children spend their time

in kindergartens, we can not completely agree with Dorfles' (1994) claim of good design. The furniture that is in the kindergartens it has not changed significantly since a hundred years ago (Eckelman et al., 2001). Haviarova and coauthors (2001) point out that “today's design of school furniture concept is mostly traditional (...) The most common forms of tables are small, with four legs, flat worktops, as well as desks with veneer and steel worktops plinth tubes. Today, worktops are most often constructed of chipboard panels coated with laminate, which is bolted to the welded construction of the plinth. Unfortunately, existing furniture is most often redesigned design and construction solutions, inconsistent with today's needs of modern education, anthropometric sizes of students and new norms, non-ergonomically designed, unstable construction and inadequate durability and strength”.

In most countries, school furniture is made of three basic materials - wood (solid or wood products), metal and plastic (Domljan et al., 2004). A school desk and chair made of solid wood are the most expensive, but at the same time the most suitable for the student, especially in terms of tactile properties, warmth, softness, and the impression of naturalness. Wood materials such as veneer board (from which back and seat moldings are made) have similar properties. Given the price of solid wood, most wood materials (chipboard and plywood) are veneered or covered with foil or laminate. Metal is most often used in the form of pipes for making plinths, which must be structurally strong and stable, so a bent or welded pipe is the most common choice. Due to the economic demands for a cheap product of large series, more and more plastic furniture is produced (back and seat of chairs, table tops and even pedestals) (Knight and Noyes, 1999), but it showed the worst properties in terms of durability, strength and maintenance. Hedge's (2015) research also shows that plastic, beside that is not an environmentally friendly material, retains more bacteria than wood at the surface.

Unfortunately, existing furniture most often is redesigned visual and construction solutions, inconsistent with today's needs of modern education, anthropometric sizes of students and new norms, non-ergonomically designed, unstable construction and inadequate durability and strength. With the development of new materials and new technologies, pedagogical equipment and educational interiors, it is expected that in the near future the current classic way of equipping children's workplaces will change significantly, certainly in anticipation of rising standards and economic opportunities.

A good designer must be aware of his social and moral responsibility. The designer should know how to shape his products and his environment, and thus, he must analyze the past, predict the future, and the consequences of his actions. Especially today, when the super-

technologically, sterile, and inhumane environment in which a person lives, has led to a planet that is constantly choking in the gray polluted air (Papanek, 1971). Using of environmentally degradable materials and giving preference to wood.

2.7. SUMMARY OF THE THEORETICAL FOUNDATIONS AND PREVIOUS RESEARCH

The analysis of the problem and the presented theoretical basis of many scientists and experts in this chapter highlight the basic problems faced by today's modern preschool pedagogy, education, psychology, kindergarten building architecture, design of the immediate subject environment of children and staff (products, furniture, equipment), the state apparatus, as well as manufacturers. These problems can be summarized in several main determinants, which also form the basis of hypothesis.

- Anthropometric values show the physical and health conditions of the individual and are influenced by various socio-economic, geographical, environmental, and genetic factors. At the same time, these values reflect the social, economic, hygienic and cultural living conditions and change accordingly (Prebeg and Prebeg, 1985; Zhecheva, 2007; Bralić, 2008).
- The knowledge of the anthropometric data and dimensions of the preschool children is of great importance in the production of wood products that children use every day for play, work and rest. Furniture is produced based on precisely determined variables and dimensions of the child's body and thus the space and environment are equipped and design (Lueder and Berg Rice, 2008; Domljan and Vlaović, 2011; Iliev, 2011; Domljan et al., 2015).
- The anthropometric research of the population of the preschool children in many countries has not been done systematically and comprehensively, so the data on the dimensions of the children from 2 to 7 years old are insufficient and outdated. However, some authors make great efforts in this field (Panero and Zelnik, 1990); Noris and Wilson, 1995; Prebeg, 1997; Živičnjak et al., 2003; Kroemer et al., 2003; Molenbroek et al., 2003; Muftić, 2005; Domljan, 2011).
- The results of the research on the appropriateness of the functional dimensions of the furniture and the anthropometric sizes of the children of preschool and school age indicate a large inconsistency, so the children do not have properly sized furniture.

(Barli et al., 2006; Voigt and Greil, 2009; Domljan, 2011; Iliev and Domljan, 2017; Iliev et al., 2018).

- The norms for the size and the quality of the furniture for the educational institutions define/determine the functional dimensions of the furniture according to the child age and the anthropometric dimensions. Unfortunately, there are few educational institutions, producers and investors who follow and apply the stated norms and guidelines. (Auf-Franić et al., 2003; ***, 2013; ***, 2015b; Domljan et al., 2015; ***, 2016c).
- The contemporary methods of preschool and school education emphasize the importance of socialization through play, which is important for a healthy social, psychophysical, cognitive and other type of development. The design of the environment and the products that the children use is important as well (Ivanovič Šekularac, 2000; Stevanović, 2001; Stoecklin, 2007; Dudek, 2008; Domljan, 2011; Fischil, 2011; Wardle, 2011; Dobrevska, 2012; Klein, 2014; Falk, 2019).
- In the buildings used for upbringing and education, the use of wood and wood materials should be encouraged, as well as new materials that will be environmentally friendly, renewable, non-toxic and safe for the health of the users, and at the same time to have a decorative, visual function. Such materials have a longer shelf life, and after the end of their life they are completely biodegradable (Papanek, 1971).
- When designing the children's products for play, work or rest, the colors in the interiors of the kindergartens should be considered, especially the influence they have on the healthy psychological development of the children. (Pisareva, 1999; Valkov, 2001; Starmer, 2005; Kirova 2006; ***, 2011; Domljan, 2011; Vodenova, 2017).
- The children have ever been treated as an object, and not as a subject of research, because the adults have not recognized their ability to think and discuss their relevant issues (problems). Today, children are seen as active collaborators in all processes of action within the educational institutions, and children's opinion is sought to be used in order to shape the products and the space they use (Dudek, 2005; Domljan, 2011; Şahin and Turkun Dostoglu, 2012; Vassiliki and Aimilia, 2012).

3. BASIC OBJECTIVES AND HYPOTHESIS OF THE RESEARCH

Based on the analysis of the referred literature, and the subject of the research, the hypotheses and the purpose of the research can be defined.

3.1. SUBJECT OF THE RESEARCH

Based on the analyzed research results so far and the analysis of the topic, the subject of this research has emerged:

The subject of the research is the design of contemporary furniture and environment used in the preschool educational institutions.

Determined by the interdisciplinary nature of the thesis, the subject of the research is divided into several activities, undertaken as follows:

1. Analysis of the anthropometric variables of preschool children with the dimensions of the furniture currently used in kindergartens, as well as harmonization of the measures of the existing furniture in the playrooms where the research was performed with the determined European standard;
2. Analysis of the attitudes and opinions of the staff in the kindergartens (teachers, caregivers and other staff) about the furniture and the spatial organization (the interior) in the playrooms;
3. Analysis of the manufacturers / distributors of kindergarten furniture for the process of production and sale of furniture and for the process of public procurement for equipping preschool facilities;
4. Analysis of teacher's and children's wishes and needs regarding the furniture and the environment, which they show through the process of play;
5. Defining the needs of the children and the teachers in an ideal system, user - furniture - environment, in order to create furniture that maintains the health of the children;
6. Defining the needs of the children and the teachers to create a fully functional and healthy atmosphere in the space in which they spend most of the day.

-
7. Determine how much wood and wood materials are present and used in interiors. Wood is ecological, sustainable environmentally friendly and healthy.

3.2. RESEARCH OBJECTIVES

Based on the defined subject of the research, the main research objectives are:

O1. To determine whether the current furniture and equipment that children come into daily contact with in kindergartens in three different countries is appropriate for the healthy growth and development of children, especially from the point of view of design, functional dimensions prescribed by applicable standards, use of wood and other environmental materials, safety and other criteria;

and

O2. To establish basic requirements for the design of kindergarten furniture and equipment, and give impetus to further research, which would involve professionals from several different scientific fields in the process of designing children's furniture.

3.3. HYPOTHESES

The following hypotheses, based on the objectives and goals are:

H1: Furniture used by children in kindergartens does not meet the requirements of modern pedagogy, design, quality, safety, ergonomics and sustainability;

and

H2: It is possible to define new contemporary requirements and criteria for product design and quality, and thus create the preconditions for preserving children's health.

It is also assumed additionally:

- The spatial organization in the kindergarten playrooms does not meet the conditions for conducting the contemporary educational process.
- In the process of public procurement of furniture for kindergartens, clear and unambiguous rules are missing in order to define the exact parameters according to which furniture that follows the psychophysical development of the children would be designed.

4. RESEARCH METHODS, POLYGONS, SAMPLES AND PARTICIPANTS

4.1. PERMISSION FOR RESEARCH WITH PRESCHOOL CHILDREN

In order to conduct research with preschool children, it was necessary to obtain special permits from the competent institutions. Permission to enter the kindergartens for the research conducted was obtained from the City Office for Education in Zagreb, from the Sofia City Municipality, and from the Department of Education and the Municipalities Butel in Skopje. Additionally, the University of Zagreb gave special permission from the Ethical Borad (Appendix VI).

In each of the kindergartens, consent was obtained from the principals. Parents have been also informed, and have given a written approval for children included in the study. Prior to the start of the research, all involved participants have had been informed about the course and the process of research. Also, everyone has been informed that the participation is voluntary, and if a child changes his mind during the research, they may withdraw from the research at any time.

4.2. RESEARCH METHODS

Five types of research methods have been used:

1. Objective measurement method;
2. Survey method;
3. Method of photographing and observing;
4. Mosaic method; and
5. Statistic analyses of the results.

4.2.1. Measurement methods

Measurement method included two types of objective measurements:

1. Measurements of the samples (chairs, tables, beds and storage furniture); and
2. Measurements of the participants (children) .

4.2.1.1. Measurement of the dimensions of the samples - preschool furniture

The chairs, tables, shelves, beds, cabinets have been measured. It has been taken a ground measure in height, depth and width. As for the chairs, as a specific element of furniture, measurements of the inclination of the seat and backrest have been taken, the lowest and the highest point of the height of the backrest have been taken. As for the tables and chairs measurements on the ground according to EN 1729-1:2015 has been taken.

The research was not made only on well-defined samples, i.e. on a specific type of furniture that was purposefully separated, but only those that appear more frequently or are necessary for performing some activity in the preschool institution.

The dimensions of all the furniture were made with a metal metro labeled in mm, and the angles were measured with a digital angle measurer expressed in degrees ($^{\circ}$).

As for the chair's measurements have been taken according to the following variables shown in Table 4 and on Figures 18 and 19.

Table 4 Measurement of variables in chairs according to EN 1729-1:2015

Symbol	Description (all dimensions in mm the angles in degrees $^{\circ}$)
h8	height of seat
b3	seat width
t4	effective depth of seat
b4	width of backrest
h7	height to highest point of backrest
α	inclination of (single-sloped) seat, degrees
γ	angle between seat and backrest
p	height of armrest above seat
r	width between armrests

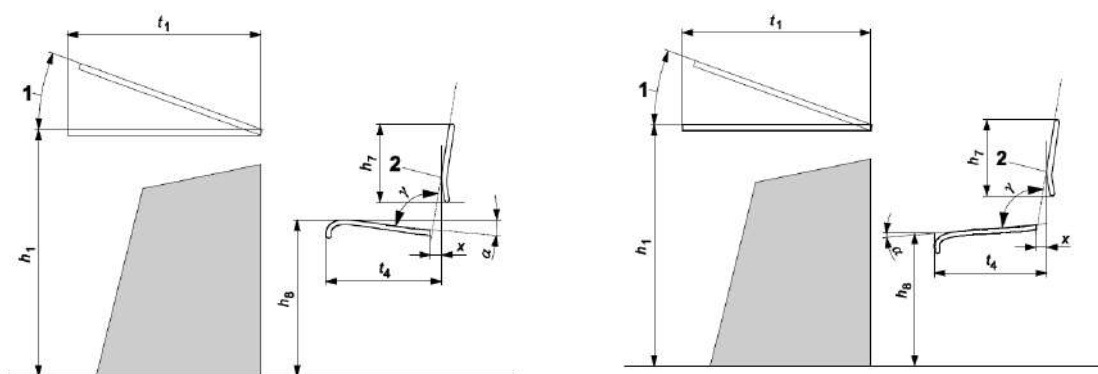


Figure 18 Reference points for tables and chairs, with sloping front and rear seats.

Source: EN 1729-1:2015

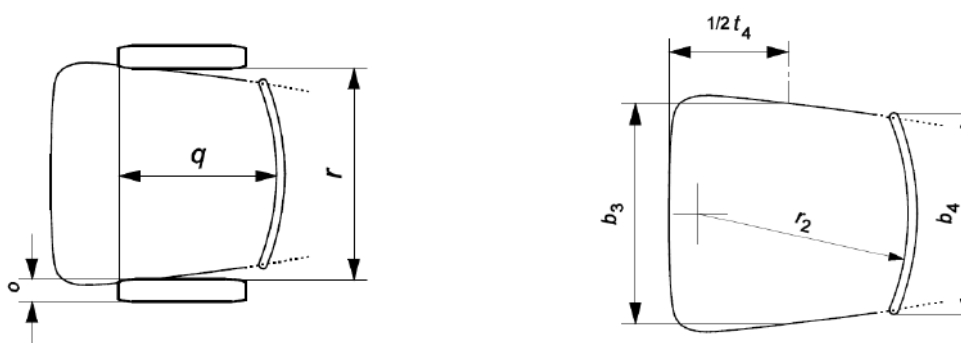


Figure 19. Baseline seat reference points.

Source: EN 1729-1:2015

For the tables measured and recorded the values have been shown in the table 5.

Table 5 Measurement of variables in tables according to EN 1729-1:2015

Symbol	Description (all dimensions in mm the angles in degrees °)
h1	height of table top
t1	height of table top
w1	width of top, per person at front edge, where pupils sit
b1	width of top surface
h9	height of footrest
y	inclination of the table top
z	vertical distance between the top of the table and the top of the seat

For the storage furniture the basic dimensions have been measured: height, width and depth.

The furniture was measured in order to determine:

1. whether the dimensions of the existing furniture deviate from the dimensions specified in the applicable standard EN 1729-1:2015.
2. whether the dimensions of the furniture in the kindergartens are appropriate for the growth of the children.
3. whether the equipment is in conformity with and in accordance with the existing regulations governing it, in each polygon separately.

4.2.1.2. Anthropometric measurements of preschool children

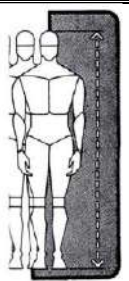
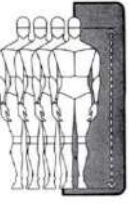
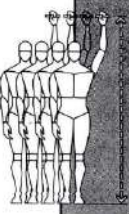
In the method of anthropometric measurements of the subjects, 16 anthropometric variables were measured. Standard body postures were used for the measurement of anthropometric variables (Salvendy, 1997):

1. *Basic posture in upright position.* The subject is in a maximal upright position, the head is in a horizontal frankfurt-plane¹¹, the upper tonsils are aligned parallel to the body, facing the body. The lower tonsils are touched next to each other.

2. *Basic posture in a seated position.* The subject is seated on a horizontal plane (during this research the respondent is seated on the chairs found in the polygons, behind the back and the paddles resting on the back). The spine is upright. The upper tonsils are bent and at right angles to the elbows, and the lower tonsils are touched to each other (Salvendy, 1997; Nacheva et al., 2012).

The measurements were made at reference points, measured from one reference point¹² to another (according to Panero and Zelnik, 1990) and are shown in the Table 6:

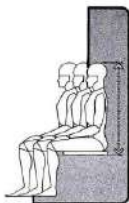

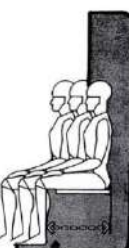
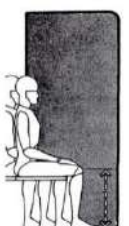
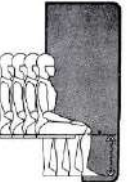
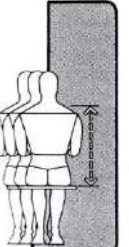

Table 6 Description of the anthropometric variables included in the research

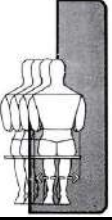
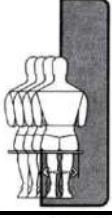
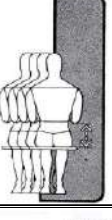
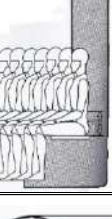
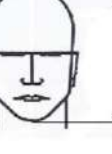
photo	symbol	variable	description
	(A)	Stature	the vertical distance from the vertex to the substrate on which the feet are placed.
	(M)	Weight	the respondent stands still and upright on the measuring instrument (scale)
	(B)	Height to the eye	Vertical distance from the substrate where the feet are set to the eyes, with the head in a frankfurt-plane. The body is in an upright position.
	(C)	Maximum reach	Vertical distance from the ground where the feet are raised to the fingertips when the arm is raised upwards and the body upright.

¹¹ horizontal frankfurt plane – plane passing through both tragions and lowest point along the lower left edge (orbitale sinistra), (Maver, et. all, 1976)

¹² Reference points are those anthropometric points that are always in the same position on the body parts. Most often these points are perceptible to morphological features of body parts, so we can easily determine their position (Buzina, et al. 1975).

4. POLYGONS, SAMPLES, RESPONDENTS AND RESEARCH METHODS

	(D)	Sitting height	Vertical distance, measured from the surface where the respondent sits to the base of the head. The body is in an upright position, its head in a horizontal frankfurt- plane. The respondent is in a seated position
	(E)	Upper leg length, buttock to knee, seated	Horizontal distance from the buttock to the farthest point of the knee, in a seated position.
	(F)	Upper leg length, buttock-popliteal length, seated	Horizontal distance from the buttock to the inner knee brace in a seated position.
	(G)	Knee height, seated	Vertical distance from the buttocks to the highest outer point of the knee, measured in a seated position, with the legs positioned at right angle to the elbow and the foreleg. The feet are fully positioned on the floor.
	(H)	popliteal height, seated	Vertical distance from the buttock to the inner knee flexion, measured in an upright posture, with the elbow and foreleg positioned at right angle. Feet completely touch the floor.
	(I)	Shoulder height, seated	Vertical distance from the substrate on which the respondent sits, to the highest point of the shoulders.
	(J)	Shoulder width	Horizontal distance from one endpoint to the other endpoint of the shoulders, in a seated position

	(K)	Width from elbow to elbow	Horizontal distance to cold, when water can be obtained and brought to justice and assist labs.
	(L)	Hip breadth, maximum when seated	The horizontal distance between the two furthest points left and right of the hips and buttocks, if the respondent is in a sitting position.
	(P)	Elbow height, seated	Vertical distance from the substrate where the respondent sits to the elbow where the upper arm and forearm are at right angle.
	(N)	Lumbar height	Vertical distance from the substrate where the respondent sits to the lumbar spine
	(O)	Head height	Vertical distance from the vertex of the head (v) to the top of the chin, the head is positioned in the horizontal frankfurt- plane.

Anthropometric variables such as height (A), body mass (M), eye height (B) and maximal reach (C) were measured in an upright position, while all others were measured in a sitting position.

The variables were written for each child, in the form provided in Appendix I. The children were measured in the preschools in which they reside and in the educational process (due to the specificity of the measured population, i.e. their age, and in consultation with principals, teachers and parents). The children were lightly dressed in T-shirts, cotton pants and barefooted. The time the children were measured in all locations was predetermined by the kindergarten staff, and ran from 9 am to 12 pm.

The variables were measured by two persons, familiar with the measurement methodology. One person doing the measurement and the other fill the form.



Figure 20 Anthropometric Measurement in Polygon I, II and III
Photo by employees, 2017

Several instruments have been used during the measurements:

- For height: Height to the eye and for maximum reach a height meter has been used, from 0 to 2000 mm;
- For weight: Digital scales (Huawei, AH100), error probability +/- 0,100 gr.;
- The other variables are measured with (the shubler mehanická) 16090014 // - from (0-600) mm, by the company "KMITEX s.r.o." with calibration sheet "č. P540 / 16", with an error margin of ± 0.02 mm. (Due to the measurement in three different cities and the inability to use an anthropometer, this type of calliper did the same job, due to the ability to measure up to 600 mm, which is sufficient for children's measures).



Figure 21 Calliper
Photo: Iliev, 2016

Children were measured in the aim to establish:

1. Comparative analysis of the anthropometric data with the dimensions of the furniture, determined according to the current standard EN 1729-1:2015.
2. Comparison of the differences in growth and development of pre-school children between polygons.
3. Comparison of the anthropometric variables and the furniture found in the polygons, in order to determine in which of the rooms the furniture does not match and does not correspond to the growth of children.

4.2.2. Survey methods

The survey was conducted at the employees of pre-school institutions (teachers and other staff) and manufacturers/distributors of pre-school furniture. Two separate surveys have been conducted, one for each group.

The purpose of both surveys was to establish, through specific polls, the most directly involved persons in relation to the real problems with the existing pre-school furniture. And by responding to their substantiated notes, offers, suggestions and tips, in accordance with the realistic, practical needs of the children, which will be implemented in improving the performance of children's furniture, both in terms of constructive – functional, as well as in aesthetic – design solutions.

4.2.2.1. Survey on kindergartens employees

The survey for employed in kindergartens was conducted to obtain information regarding:

- the current state of furniture and problems that exist with currently used furniture;
- the way the teaching process is maintained;
- opinions about the furniture they think is needed in the room where the children are staying, which would be most appropriate for working with children.

The teacher surveys have been divided into 6 thematic sections with a total of 74 questions. Table 7 shows the structure of the survey, the number of questions for each group separately and the content of the questions per group. The survey is presented in full in Appendix II.

4. POLYGONS, SAMPLES, RESPONDENTS AND RESEARCH METHODS

Table 7 Structure of the surveys for respondents – kindergarten employees

Number of questions	Content of the questions per groups
21	General information about the respondent and the area in which he / she works
12	Questions about the children's chairs
8	Questions about the children's tables
9	Questions about the children's beds
7	Questions about the children's furniture for disposal and storage (storage furniture)
17	Other questions related to the shape of the furniture and the interior environment
74	Total

The surveys for the employees in the kindergarten have been conducted to obtain important information, opinions and attitudes from each teacher, in order to eliminate and solve existing problems and to define the needs for designing new preschool furniture more clearly and precisely.

The completion of the surveys has been conducted in agreement with the staff in charge of the kindergartens in the municipalities in the three polygons and with the principal of each preschool separately.

4.2.2.2. Survey on manufacturers / distributors

The surveys in each location have been conducted in a different way. E-mails were sent to 13 company in Zagreb. The first contact was made with the assistance of an officer employed by the City Education and Sport Education Unit. Then was made second contact, from eight of the surveyed manufacturers, response was received from four. In Sofia and Skopje the surveys have been distributed at each firm's headquarters in hard copy.

The point of this survey was to obtain data on the areas of knowledge of the design and production of preschool furniture, the manner and conditions of producing its own production program; views on the current way of equipping preschools and suggestions for improving the current situation.

Structurally the survey has been divided into five groups of questions, with a total of 53 questions (Table 8). The layout of the survey is attached in Appendix IV.

Table 8 Structure of the surveys – manufacturers

Number of questions	Content of the questions per groups
4	Basic company information
20	Questions about public procurement for equipping kindergartens
13	Manufacture of the furniture produced / offered on the market
10	Development and design of the products that are manufactured
6	Production Criteria
53	Total

4.2.3. Mosaic method

Children were once an object rather than a research subject because adults did not acknowledge their ability to think and talk about relevant issues (Vassiliki and Aimilia, 2012). In 2001, Alison Clark and Peter Moss devised a Mosaic approach to reflect on this issue. Their intention was to ensure, in an efficient and simple way, that every child's voice was heard during preschool years. By "listening" we mean meaningful and exhaustive communication between the child and the adult through all communication channels – verbal, non-verbal, through all senses and emotions. This is an open, honest and multifaceted process (Vassiliki and Aimilia, 2012).

The mosaic method has been implemented in agreement with the directorate of the kindergarten and the City Office for Education in Zagreb and with the permission of the parents of the children. When answering the questions, the children were seated in a group and each question was followed by a play and a conversation and the corresponding answer was given. The questionnaire set consisted of five questions and one task: to draw their own kindergarten playroom from their imagination. The content of questionnaire was photographs of preschool furniture, photographs of different kinds of flooring and check-box for their favorite colour. The answer was to indicate the most used furniture of all that have been proposed. The appearance and content of the questionnaire was given in Appendix V.

4.2.4. Observation and photography of furniture and children

Constructive solution of furniture, the spatial organization in playrooms, space design and children behavior has been digitally photographed during the process of working, playing and eating.. The photos were taken with digital camera (Fine Pix 4700 zoom, Fuji Photo Film Co., Ltd., Japan).

The purposes of photography were:

1. to determine the condition of furniture;
2. the position of the child's body in a chair and at a table when sitting or performing other accompanying activities;
3. to determine whether the furniture used is appropriate for this age in all its shapes, construction, anthropometric standards, ergonomic parameters and the like.

4.2.5. Statistical data processing method

For statistical analysis standard statistical methods were used. All collected data are presented with absolute and relative frequencies, while numerical data are presented with arithmetic mean and standard deviation if distributed within parameters of normal Gaussian distribution. Numerical data that does not fit normal distribution are presented with median and interquartile range. Results are presented in tables or in graphs and explained in the chapter 5 *Results*.

Chi-Square Test was used for comparison of categorical data between and among categories, and if need it was substituted with Fisher's Exact Test. Differences between two independent sets of numerical data were tested with nonparametric Mann-Whitney U-Test, while differences between more than two independent sets of numerical data were tested with nonparametric Kruskal-Wallis Test and Conover post-hoc Test.

Statistical analysis was done with either MedCalc (19.1.3, MedCalc Software) or IBM SPSS Statistics (release 24.0.0.0) software tools, with statistical significance defined as $\alpha=0.05$, where all P values were two-tailed.

4.3. POLYGONS

The research has been conducted in the period from January 2017 to January 2020 in three capitals in three countries:

- I. Skopje, Republic of North Macedonia (Location I)
- II. Zagreb, Republic of Croatia (Location II),
- III. Sofia, Republic of Bulgaria (Location III).

The polygons are selected based on predetermined methods, diversity and the number of furniture-samples and respondents.

4.3.1. Polygons in the measurement method

The measurement method was conducted at all locations. Two types of measurements were used:

- measurement of furniture-samples – children's furniture, used by preschoolers only; and
- anthropometric measurements of the children.

4.3.1.1. Polygons in the method of measurement of the samples-furniture

The survey of objective measurement of the samples includes all polygons shown in the Table 9.

The polygons are selected so that it can be seen whether and how one or the other parameter influences the choice of different types of furniture in the playrooms where the children stay; to compare and determine if any of the different parameters affect the use of different types of furniture. The playrooms at the time of the taking measurement were fitted with standard preschool furniture, such as tables, chairs, shelves, lockers (for personal belongings), bed lockers and beds.

Table 9 Kindergartens included in the measurement methods

Location	city /country	Polygon, (kindergarten)	Construction type	Furniture type	Group type
I	Skopje, Republic of North Macedonia	“Majski Cvet”, Municipality of Karposh	modern building from the 20th century	old and new	Homogeneous
		“11-ti Oktomvri”, Municipality of Butel	modern building from the 20th century	old	Heterogeneous
		“Kocho Racin”, Municipality of Centre	contemporary building	new	Homogeneous
		“Tashko Karadza”, Municipality of Butel	modern building from the 20th century	old	Homogeneous
		“13-ti Noemvri”, Municipality of Centar	modern building from the 20th century	new	Homogeneous
		“Park”, Municipality of Centar	modern building from the 20th century	new	Homogeneous
		“Buba Mara”, Municipality of Aerodrom	modern building from the 20th century	old and new	Homogeneous
		“Sonce”, Municipality of Aerodrom	contemporary building	new	Homogeneous
II	Zagreb, Republic of Croatia	“Različak”, Petrinjska street.	modern building from the 20th century	old and new	Heterogeneous
		„Različak”, Jurišićeva street	modern building from the 20th century	old and new	Heterogeneous
		„Različak“, Amruševa street	modern building	old and new	Homogeneous
		“Trešnjevka”, Trakošćanska street	building from the 20th century	old	Homogeneous heterogeneous
		“Trešnjevka”, Badalićeva street	building from the 20th century	old and new	Homogeneous heterogeneous
		“Medveščak”, Voćarska street	modern building from the 20th century	old	Homogeneous
		“Medo Brundo”, Dubrava 185 street	contemporary building	new	Homogeneous
		“Jarun”, Bartolića street	contemporary building	new	Homogeneous
		“Rementinec”, Lanište street	contemporary building	old and new	Homogeneous

4. POLYGONS, SAMPLES, RESPONDENTS AND RESEARCH METHODS

		“Špansko”, Špansko street	modern building from the 20th century	old	Homogeneous
		“Sunčana”, Dječji trg 2	contemporary building	old and new	Homogeneous
		“Šumska jagoda”, Sveti Duh street	modern building from the 20th century	old	Homogeneous
III	Sofia, Republic of Bulgaria	“Bratya Mormarovi”, Vrabcha 7 street	adapted building	old	Heterogeneous
		“Bratya Mormarovi”, ul. Pobeda	contemporary building	old and new	Heterogeneous
		“Moyat Svyat”, Chumerna 15 street	modern building from the 20th century	old and new	Heterogeneous
		“Brezichka”, Vladimir Trendafilov 5 street	building from the 20th century	old	Homogeneous heterogeneous
		“Zdrave”, Mayor Yuriy Gagarin 16 street	building from the 20th century	old	Homogeneous heterogeneous
		“Slance”, Todor Stoyanov 18 street	building from the 20th century	old	Homogeneous
		“Zornica”, Eugene Poitier 1 street	20th century building with new additions	old and new	Homogeneous heterogeneous

The polygons differ according to:

- *Geographical location of kindergartens:*

They are located in three different countries. In each city, the selected kindergartens cover both central and suburban areas (Table 10).

Table 10 Locations of the kindergartens in city area

question/answers	number (percentage) of answers in each group			P	n (%)
	<i>Skopje</i>	<i>Zagreb</i>	<i>Sofia</i>		
Part of the city where the kindergarte is located					
narrower centre	119 (53.8)	37 (25.3)	88 (44.0)	<0.001	244 (43.0)
wider centre	86 (38.9)	107 (73.3)	112 (56.0)		305 (53.8)
outside of settlement	16 (7.3)	2 (1.4)	0		18 (3.2)

In Skopje, kindergartens have been selected from several municipalities. Each municipality is a separate administrative unit. This is not the case with Zagreb and Sofia, where all kindergartens are under the authority of the city.

- *Architectural solution and type of building:*
 - Buildings intended for pre-school activities;
 - Buildings adapted for pre-school institutions;
 - Buildings originating from the 20th century and
 - Contemporary buildings.
- *The number of children in the groups is from 15 to 45.*

In all of the kindergartens, the groups are more numerous than the standards prescribed in each of the three countries (Table 11).

Table 11 Number of children in a working group (playroom)

question/ answers	number (percentage) of answers			P	n (%)
	Skopje	Zagreb	Sofia		Total
Total number of children in the working group					
less than 10	2 (0.9)	0	0	<0.001†	2 (0.4)
11-15	4 (1.8)	4 (2.8)	0		8 (1.4)
16-20	27 (12.3)	28 (19.3)	4 (2.0)		59 (10.5)
21-25	43 (19.6)	59 (40.7)	33 (16.8)		135 (24.1)
25-27	88 (40.2)	32 (22.1)	62 (31.6)		182 (32.5)
28-30	55 (25.1)	19 (13.1)	74 (37.8)		148 (26.4)
more than 30	0	3 (2.1)	23 (11.7)		26 (4.6)

- *Depending on age of children* groups were organized into: homogeneous¹³, heterogeneous¹⁴ and combined groups (***, 2013). In Skopje and Zagreb most of the kindergarten groups are homogeneous, i.e. children are at the same age; while in Sofia most of the groups were heterogeneous, which makes it particularly difficult to choose appropriate furniture.
- *The furniture in the kindergartens* divides by type into old and new.
- *Spatial organization* and type of furniture for each city separately. Conceptually, the playrooms where the children stay are arranged differently.

4.3.1.2. Polygons in anthropometric measurements

Anthropometric data were measured on the preschool children in all three cities. The polygons differ according to the number and age of the respondents (Table 12).

Table 12 Kindergartens included in the anthropometric measurements

City / country	Polygon	N
Skopje, R. of N. Macedonia	Majski cvet, 11-ti Oktomvri, Kocho Racin, Tashko Karadza, 13-ti Nomezri	5
Zagreb, R. of Croatia	Različak, Petrinjska street; Različak, Jurišičeva street; Špansko, Špansko street; Trešnjevka, Badaličeva street	4
Sofia, R. of Bulgaria	Bratya Mormarovi, Moyat svyat, Zdrave, Brezichka, Slance, Zdrave	6

¹³Homogeneous group: up to 12 months; 12 to 18 months; from 18 months to 2 years, from 2 to 3 years; from three to four years; from 4 to 5 years; and from five to six years.

¹⁴Heterogeneous group: up to 2 years of age and from 2 years until starting school.

4.3.2. Polygons in the survey method

The survey covers polygons in all cities, as well as manufacturers and distributors of kindergarten furniture from the three observed locations.

The survey differs according to the type of the polygons and the type of the respondents (Tables 13 and 14).

Table 13 Kindergartens included in the survey method

Locations	City	Polygon	N
I Republic of N. Macedonia	Skopje	Tashko Karadza	13
		11 oktomvri Butel I	26
		11 oktomvri Butel II	8
		Buba Mara	13
		Sonce	7
		Majski Cvet Taftalidze I	14
		Majski Cvet Taftalidze II	18
		Majski Cvet	12
		Beli Mugri	11
		Panorama	9
		Kocho Racin	19
		Naum Naumovski Borche	16
		13 –ti Noemvri	24
		Park	14
		Jasmin	12
Kukushka	5		
Total Polygon I			221
II Republic of Croatia	Zagreb	data obtained from the Internet	26
		Razlichak, ul Petrinjska 31	26
		Razlichak, ul Podrebernica 15	9
		Razlichak, ul Jurisiceva	4
		Shpansko ul. Špansko 11	36
		Remetinec ul. Lanište 1d	37
		Trešnjevka ul. Badalićeva 24	20
		Trešnjevka ul. Trakošćanska 45	14
Total Polygon II			172
III Republic of Bulgaria	Sofia	Zornica	15
		Slance ul. Todor Stoyanov No. 18	18
		Zdrave ul. Juruj Gagarin 14-16	13
		Detelina ul. Dean Belishki	15
		Radecki ul. Nikola Gabrovski 25	4
		Bratya Mormarovi ul. Vrabcha 7	18
		Bratya Mormarovi ul. Pobeda	7
		Moiat Svjat ul. Chumerna 15	18
		Moiat Svjat ul. Veslec 31	7
		Mojat Svjat ul. Tcar Simeon 5	6
		Brezichka ul. Vladimir Trendafilov No. 5	17
		Radost ul. Pimen Zografski 5	14
		Prikazka ul. Suhodolska No. 2	10
		Zhar ptica ul. Dobrotich 48	30
Feniks ul. Suhodolska No. 2	8		
Total polygon III			200
Total for all of 3 polygons			593

Table 14 Distribution of respondents by survey method by location

Type of respondents	Locations	Total number
Respondents - employees in the kindergartens	Kindergartens in: Skopje, Zagreb and Sofia.	N=593
Respondents - manufacturers, distributors	Factories and distributors from: the Republic of Macedonia, the Republic of Croatia and the Republic of Bulgaria.	N=12

4.3.3. Polygons in the Mosaic method

Due to the specificity and workload of implementing this method, only one polygon and one kindergarten were selected. The Mosaic method was conducted at the polygon II - Zagreb, in the kindergarten Špansko, Špansko 11 street. The conditions and the way of working in the educational process as well as the type of furniture in the kindergarten, were not significantly different from the other kindergartens. The choice was random and unintentional.

4.3.4. Polygons in the method of observation and photographing

Observation and photographing the preschool children and furniture were done at all three locations (Table 9).

4.4. FURNITURE SAMPLES

Samples of furniture were taken directly from the polygons. All samples were analyzed and included in the survey, according to the methods performed. Most of the polygons had the same or similar furniture, with models depending on the manufacturers. They differ in the shape and constructive solutions, dimensions and materials used.




The research is not only done on specially designated specimens, i.e. on a certain type of furniture that is purposefully separated, but on all the furniture in the children's institutions. The aim was to inspect the current state of all furniture used in the preschools.

The photographs in the Tables 15-18 presented show the types of furniture that were used in kindergartens at the time of shooting. The furniture types are divided according to the function for which they are intended and according to the structural-design solutions.





4.4.1. Chairs

In the Table 15 are described all types of chairs found in observed polygons.





Table 15 Types of chair

TYPE	DESCRIPTION	PHOTO
LOCATION I		
A	The seat and the backrest are made of molded veneer beech press, of the molded veneer beech press. The legs, the seat carrier, as well as the subconstruction are made of veneer beech press. The chair is connected with visible screws, four (4) pieces on the backrest and four (4) or six (6) on the seat, depending on the manufacturer. The surface has been treated with wood varnish, and for the coloured chairs also wood paint has been used. The front of the seat is curved, a small horizontal radius on the seat, a backrest without expressed lumbar part.	
B	The seat and the backrest are made of molded steam beech veneer press. The legs, the seat carrier as well as the sub-construction are made of veneer beech presses. The chair is connected with visible screws, four (4) pieces on the backrest and six (6) on the seat. The surface has been treated with wood varnish. The front of the seat is curved, a small horizontal radius on the seat, a backrest without expressed lumbar part, and a backrest inclination.	
C	The chair is entirely made of solid wood - beech, the seat is connected by screws that are visible, while the other elements are connected by a solid connection, a pen and a groove. The backrest is without expressed lumbar part and without backrest inclination. The seat follows the line of the buttocks, so a recess is made. The front is with larger dimension than the back.	





4. POLYGONS, SAMPLES, RESPONDENTS AND RESEARCH METHODS

D, D1	<p>The legs, the seat and the backrest as well as the sub-construction are made of solid beech wood. The seat and backrest are made of veneer beech presses and are painted with wood paint. The seat is supported by a rectangular sub-construction which is connected with 4 visible screws. The backrest is rectangular in shape and is also held connected with 4 visible screws to the backrest carrier.</p> <p>The front part of the seat is curved, the backrest is without expressed lumbar part and with inclination.</p>	
E	<p>The seat is made of painted medium density fiberboard (MDF), while the backrest is made of molded and painted MDF. This type of chair has four legs and two backrest support that are made of beech veneer presses. The seat has a round shape, while the backrest is with rectangular. All of the edges are rounded. The 4 legs are screwed directly into the seat.</p>	
F	<p>Made of high-quality cast plastic, for indoor and outdoor use. The seat and the backrest have rounded corners and are at right angles. At the bottom of the legs there are black blisters (removable stop gaps) that are removable. The height regulation of the chair can differ depending on the height of this stopgaps which are available in two different heights.</p>	
G	<p>The chair is made of polypropylene at a single pressure, so it is very solid and durable. It has CE, SGS certificate. Available in 4 colours: red, blue, green and yellow.</p>	





4. POLYGONS, SAMPLES, RESPONDENTS AND RESEARCH METHODS

H	<p>This type of chair is used only in the nursery groups. They are intended for feeding the children. The legs and the sub-construction are made of solid pine wood, the seat and the backrest are upholstered. The part that is intended for the food, i.e. the plate on which the food is placed, is made of laminated plywood. The connections are visible, i.e. the chair is fastened with screws.</p>	
J 1	<p>Upholstered furniture (two-seater and stool) found in the music cabinet in one of the kindergartens. The sub-construction is made of raw plywood, upholstered with sponge.</p>	
LOCATION II		
I II	<p>Chair on 4 legs, made of solid natural beech wood, the back and upper part of the seat are made of veneer beech presses, the surface is treated with wood varnish. On the lower end of the legs there are canvas patches that do not allow slipping on the floor or the surface on which the chair is mounted. The seat is at right angle with a slight recess following the line of the buttocks. Slightly curved front part of the seat. The backrest is rectangular with rounded edges. The connections are not visible. The backrest is without expressed lumbar part. NOTE: In one kindrgarten only, this type of chair (II) with smaller dimensions has been found.</p>	
K	<p>Chair on 4 legs, with sub-construction holding the seat. On the lower end of the legs there are canvas patches that do not allow slipping on the floor or the surface on which the chair is mounted. The seat is at right angle with a slight recess following the line of the buttocks. The front part of the seat is slightly curved. The backrest is rectangular with rounded edges. It has also armrests that are attached to the backrest holder and directly to the seat. The connections are not visible. The backrest is without expressed lumbar part. The entire chair is made of solid beech wood nature and the surface is treated with wood varnish. It is used in the rooms where the nursery units, i.e. the children from 1 to 3 years, are staying.</p>	






4. POLYGONS, SAMPLES, RESPONDENTS AND RESEARCH METHODS

L	<p>Chair for nursery group, with 4 legs and backrest in irregular shape that is built between the seat and the armrests. Made of veneer press from steamed beech wood nature, with the surface coated with PU transparent varnish. A chair with a negative seat angle:</p> <p>NOTE: This type of chair is no longer in use, due to uncomfortable seating and slippery seat</p>	
M	<p>Upholstered armchair, with raw plywood sub-construction.</p>	
N, N1, N2, N3	<p>The seat and the backrest are made of molded veneer beech press. The legs, the seat carrier as well as the sub-construction are made of veneer beech press. The chair is connected with visible screws, 4 pieces on the backrest and with 4 or 6 on the seat, depending on the manufacturer. The surface has been treated with wood varnish, and for the coloroued chairs also wood paint has been used. The front of the seat is curved, a small horizontal radius on the seat, a backrest without expressed lumbar part.</p> <p>Note: This type of chair has been found in the most of Zagreb's polygons. In almost every building the dimensions have been different. This is due to the different manufacturers and the age of the furniture. Some of the chairs have been over 30 years old, when there existed another type of standard</p>	
O	<p>The seat and the backrest are made of veneer beech press. The legs and the chair construction are made of solid beech turning elements bonded with a permanent connection, pen and groove.</p>	


4. POLYGONS, SAMPLES, RESPONDENTS AND RESEARCH METHODS

P, P1 P2	<p>Construction (legs and backrest support) made of wrought steel profiles paint coated.</p> <p>At the bottom of the legs wooden borders are set, the screws are visible. The backrest and the seat are made of lacquered molded veneer press, beech nature. Slightly curved front, a backrest without expressed lumbar curvature. The backrest is of irregular shape, laterally cut at the top.</p>	
R, R1, R2	<p>Construction (legs and backrest support) made of wrought steel profiles paint coated, at the end of the legs there are white PVC borders. The backrest and the seat are made of molded veneer press, made of beech; painted in colour, the front part of the seat is sloped downwards and with rounded corners, a backrest without expressed lumbar curvature (w). Small horizontal radius on the seat. Semicircular arched upper and lower part of the backrest.</p>	
S	<p>Chair made of plastic, for the nursery groups. The seat and the backrest are molded into a single mold. Legs are separately molded and attached after.</p>	
LOCATION III		
T	<p>Cast plastic chair on 4 legs. The front of the seat is slightly curved. The entire structure of the chair has rounded edges. The seat has a straight angle, while the angle of inclination is 10°. It is used in all age groups, from 3 to 7 years. Chair that is most widely used at the research polygons.</p> <p>Note: In most of the kindergartens in Sofia chairs of this type were found.</p>	

4. POLYGONS, SAMPLES, RESPONDENTS AND RESEARCH METHODS

U, U1	<p>This type of chair is used in playrooms in which children from 3 to 7 years stay. Classic chair on 4 legs, with seat and backrest at the angle of 90°. There is no lumbar part expressed on the backrest. The connections are not visible and are of the pen and groove type. The whole chair is made of solid attic wood, painted with PU. There are no sharp edges.</p>	
V	<p>Chair made of attic wood, lacquered with transparent PU. The backrest has no slope, the seat is at right angle. There is no lumbar part expressed on the backrest. The connections are not visible and are of the pen and groove type. The chair is used in playrooms in which children from 3 to 7 years old are staying during the day-</p>	
W	<p>Upholstered corner sofa with undercover on piles of plates made of attic wood. It is used in the so-called creative center (family). It consists of a two-seater, an angular section and a three-seater.</p>	
X	<p>The chair is made of solid beech wood. The front legs are fastened, while the rear ones continue as the backrest support. Its shape is rectangular. One of the specifics of this chair that makes it different from the others is the surface treatment, i.e. it is all painted with floral motifs. The connections are not visible and are made of pen and groove, using glue.</p>	
Y	<p>Construction made of profiles of steel pipes paint coated in white, at the end of the legs there are white PVC borders. The backrest and the seat are made of upholstered PU leather material and are screwed directly to the construction. Seat with round corners and backrest without lumbar curvature expressed (w) in rectangular form.</p>	



4. POLYGONS, SAMPLES, RESPONDENTS AND RESEARCH METHODS

Z	<p>Metal construction that in some places is tightly bonded (welded), and on the rest is screwed, painted in white. At the lower part of the legs there are plastic borders. The seat is attached to the backrest (one segment) and is made of a fine mesh synthetic fabric. The front of the seat is slightly sloping downwards. The upper part of the backrest is oblique to the outside, with slightly sloping lumbar curvature.</p>	
---	---	--






4.4.2. Tables

In the Table 16 are described all types of tables found in observed polygons.






Table 16 Types of tables.

TYPE	DESCRIPTION	PHOTO
LOCATION I		
1	<p>A table designed for 4-6 children, height adjustable, but without slope. The regulation is with a system mounted on the legs themselves and consisting of two metal tubes that draw into one another. The lower tube which is movable has a small protruding portion and enters the upper which is fixed and has holes. At the desired height, the protruding part of the lower enters the hole in the upper tube. The table is on 4 legs that are directly attached to the worktop. The legs are made of metal and the trunk is trapezoidal and is made of melamine faced chipboard in white on the top. The ABS edging.</p>	
2	<p>A table designed for 4-6 children, height adjustable, but without slope. The regulation is with a system mounted on the legs themselves and consisting of two metal tubes that draw into one another. The lower tube which is movable has a small protruding portion and enters the upper which is fixed and has holes. At the desired height, the protruding part of the lower enters the hole in the upper tube. The table is on 4 legs that are directly attached to the worktop. The legs are made of metal and the trunk is round and is made of melamine faced chipboard in white on the top. The ABS edging.</p>	





4. POLYGONS, SAMPLES, RESPONDENTS AND RESEARCH METHODS

3	<p>A table designed for 4-6 children, without adjustable height and without slope. The table has 4 legs that form a rectangular substructure at the top that holds the worktop. The legs are made of veneer beech press. The worktop is rectangular with sharp angles Made of melamin faced chipboard in white with edging of solid wood.</p>	
4	<p>A table designed for 4 children, without adjustable height and slope on the worktop. There are 4 legs that form a rectangular substructure at the top that holds the worktop. The legs are made of veneer beech press. The worktop is round and made of MDF, painted in a variety of colours.</p>	
5	<p>A table designed for 4 children, without adjustable height and slope on the worktop. There are 4 legs that form a rectangular substructure at the top that holds the worktop. The legs are made of solid beech wood. The worktop is rectangular and made of plywood, coated with foil in different patterns, with ABS bands and has rounded edges.</p>	
6	<p>A table designed for 6 children, without adjustable height and slope on the worktop. There are 4 legs that form a rectangular substructure at the top that holds the worktop. The legs are made of solid beech wood. The worktop is rectangular with sharp edges, made of beige decorated melamin faced chipboard edged with solid wood.</p>	
7	<p>A table designed for 4 children, without adjustable height and slope on the worktop. The four polypropylene legs mounted on the top of the workbench are mounted in separate bearings, providing strength and durability at any pressure. The worktop is round and made of melamin faced chipboard in different decors.</p>	






4. POLYGONS, SAMPLES, RESPONDENTS AND RESEARCH METHODS

8	<p>A table designed for 4 children, with adjustable height and without slope on the worktop. The regulation is carried out through the black levellers at the bottom of the legs and with maximum extension through screwing of 3 cm.</p> <p>The legs are made of metal, painted in the colour of the work flap, and mounted on the upper side.</p> <p>The worktop is rectangular with rounded edges and made of PVC polypropylene.</p>	
LOCATION II		
9	<p>A table designed for 4 to 8 children, without adjustable height and without slope on the worktop.</p> <p>The table has 4 legs that form a rectangular substructure at the top that holds the worktop. The legs are made of solid beech wood. The worktop is rectangular with sharp edges, made of white melamine faced chipboard with solid wood edging.</p> <p>This type of table is used in the groups for children of age 3 to 7 years.</p>	
10	<p>A table designed for 2 to 3 children, without adjustable height and without slope on the worktop.</p> <p>The table has 3 legs and semicircle substructure top that holds the worktop. The legs are made of solid beech wood.</p> <p>The worktop is semi round, made of melamine faced chipboard in light décor edged with solid wood edge.</p>	
11	<p>A table designed for 4 to 8 children, without adjustable height and without slope on the worktop.</p> <p>The table has 4 legs that form a rectangular substructure at the top that holds the worktop. The legs are made of solid beech wood.</p> <p>The worktop is in a circled shape and made of melamine faced chipboard in natur beech décor and it is edged with ABS.</p>	
12	<p>A table designed for 6 children, without adjustable height and without slope on the worktop.</p> <p>The table has 4 legs that form a rectangular substructure at the top that holds the worktop. The legs are made of metal and are painted in yellow.</p> <p>The worktop is consisted of three pieces: one rectangle and two semicircles positioned on two opposite sides of the rectangle. The semi round worktops are screwed with piano hinges on the rectangular worktop, which is held by two movable metal rods that can be pull forward or backward.</p> <p>The worktops are made of melamine faced chipboard with white décor and it is edged with solid wood.</p>	

4. POLYGONS, SAMPLES, RESPONDENTS AND RESEARCH METHODS

13	<p>A table designed for 4 children, without adjustable height and without slope on the worktop.</p> <p>The table has 4 legs that form a rectangular substructure at the top that holds the worktop. The legs are made of metal and are painted in red, with plastic stoppers on the bottom.</p> <p>The worktop is rectangular, made of melamine faced chipboard edged with solid wood edge.</p>	
14	<p>A table designed for 8 children, without adjustable height and without slope on the worktop.</p> <p>The table has 4 legs that form a rectangular substructure at the top that holds the worktop. The legs are made of metal and are painted in yellow, with plastic stoppers on the bottom.</p> <p>The worktop is rectangular, made of melamine faced chipboard with white décor and it's edged with solid wood edge.</p>	
15	<p>A table designed for 6 to 8 children, without adjustable height and without slope on the worktop.</p> <p>The table has 4 legs that form a rectangular substructure at the top that holds the worktop. The legs and the worktop are made of polypropylene in a single pressure, with plastic stoppers on the bottom.</p>	
16	<p>A table designed for 4 to 6 children, without adjustable height and without slope on the worktop.</p> <p>The table has 4 legs that are screwed directly to the worktop. The legs are made of metal with a satin finish, with plastic stoppers on the bottom.</p> <p>The worktable is rectangular with rounded edges. The worktop made of melamine faced chipboard edged with ABS.</p>	

4. POLYGONS, SAMPLES, RESPONDENTS AND RESEARCH METHODS

17	<p>A table designed for 4 children, without adjustable height and without slope on the worktop.</p> <p>The table has 4 legs that form a rectangular substructure at the top that holds the worktop. The legs are made of veneer beech press.</p> <p>The worktop is rectangular with sharp edges, made of melamine faced chipboard with white décor with solid wood edging.</p>	
18	<p>A table designed for 4 children or for 8 to 10 children, without adjustable height and without slope on the worktop.</p> <p>The table has 4 legs that form a rectangular substructure at the top that holds the worktop. The legs are made of solid beech wood and are painted in blue and yellow.</p> <p>The worktop is rectangular with rounded edges/ round shape and made of solid wood of multy-ply panel.</p>	 
LOCATION III		
19	<p>A table designed for 6 children, without adjustable height and without slope on the worktop.</p> <p>The table has 4 legs that form a rectangular substructure at the top that holds the worktop. The legs are made of metal and are painted in white, with plastic stoppers on the bottom.</p> <p>The worktop is rectangular with rounded edges. The worktop is made of melamine faced chipboard in beige décor and it's edged .</p>	 

4. POLYGONS, SAMPLES, RESPONDENTS AND RESEARCH METHODS

20	<p>A table designed for 4 children, without adjustable height and without slope on the worktop.</p> <p>The construction of the table consists of two pieces melamine faced chipboard with transverse cross-lath.</p> <p>The worktop is rectangular and made of melamine faced chipboard with beige décor and edged with ABS.</p>	
21	<p>A table designed for 4 to 6 children, without adjustable height and without slope on the worktop.</p> <p>The table has four legs that are directly screwed to the worktop. The legs are made of metal with a satin finish, with plastic stoppers on the bottom.</p> <p>The worktop is of asymmetric shape, one side of the rectangle is with convex concave curve. It's made of melamine faced chipboard with Abs edging.</p>	
22	<p>A table designed for 4 to 6 children, without adjustable height and without slope on the worktop.</p> <p>The table has four legs that are directly screwed to the worktop. The legs are made of metal with a satin finish, with plastic stoppers on the bottom.</p> <p>The worktop can be rectangular, semiround or trapezoidal. It is made of melamine faced chipboard with ABS edging.</p>	





4.4.3. Beds

In the Table 17 are described all types of children's beds found in observed polygons.




Table 17 Types of children's beds by polygons

TYPE	DESCRIPTION	PHOTO
LOCATION I		




4. POLYGONS, SAMPLES, RESPONDENTS AND RESEARCH METHODS

A1	<p>A bed with four movable legs. The legs can be folded when the beds are placed in the lockers where they are stored or released when the beds are placed in the room and are used for their intended purpose. It is made of solid steamed beech.</p>	
A2	<p>A baby cot used in nursery groups. It is constructively composed of a front and a back panel that are made of massive frame with MDF filling, painted in white and of two longer sides made of solid wood that have been produced using turning wood.</p>	
A3	<p>A baby cot used in nursery groups. This baby crib is constructed of 4 high sides that serve as a safety fence. One of the sides of the cot is movable, allowing to lower the fence height and easier access. The mattress is mounted on MDF board. The bed is made of solid beech elements that have been produced using turning wood.</p>	
LOCATION II		
B1	<p>Mattresses, which are coated with artificial leather, for easier maintenance. They are located in one corner of the room. The mattresses are placed directly on the floor.</p>	

4. POLYGONS, SAMPLES, RESPONDENTS AND RESEARCH METHODS

B2	<p>Rectangular aluminum frame, with plastic elements fixed to the angles, that have the functions of legs. Throughout the length of the bed there is mesh material, which is stretched and covers the aluminum frame.</p>	
LOCATION III		
C1 C1a	<p>Bunk bed that is used for children from 3 to 7 years. The construction contains: the headboard, backboard, as well as the two sides form a rectangular frame made of melamine faced chipboard. All sides of the frame are with equal height. The legs are made of metal tube, with rectangular profile, painted in blue. They are screwed directly to the outside sides and at the same time they hold the upper and the lower bed. The mattress is held on a raw chipboard, mounted on a subconstruction that is fastened to the bed frame. On one of the sides there is a screwed metal ladder, made of the same pipe profile. In this polygon, beds of the same type are used, with the exception that the upper bed has fences that perform a security function (the bottom picture). The headboard and the backboard are higher than the sides and are with rounded corners.</p>	
C2	<p>Singlebed, used for children from 3 to 7 years. The headboard and one of the sides are higher, and together with the backboard and the other side they form a rectangular frame made of melamine faced chipboard. The legs are made of metal tube with a rectangular profile, painted in black, screwed directly to the inner side of the sides. The mattress is held on a raw chipboard, mounted on a subconstruction that is fastened to the bed frame.</p>	

4. POLYGONS, SAMPLES, RESPONDENTS AND RESEARCH METHODS





C3	<p>The headboard and one of the sides are higher, and together with the backboard and the other side they form a rectangular frame made of melamine faced chipboard.</p> <p>The headboard and the backboard take over the role of legs and hold the entire construction.</p> <p>The mattress is held on a raw chipboard, mounted on a subconstruction that is fastened to the bed frame. During the research, beds of the same construction but with different dimensions, were found.</p>	
C4	<p>A baby cot used in the nursery groups. It is constructively made of combined materials, i.e. one of the sides is made of frame with elements that have been produced using wood spinning lathe and the other three sides of melamine faced chipboard. The mattress is mounted on a raw chipboard.</p>	
C5	<p>Bunk beds that are used for children from 3 to 7 years.</p> <p>The structure is cube-shaped, with openings on the sides. One bed is on the upper part of the structure and the other bed on the lower. The headboard and the backboard are higher than the sides and are with rounded corners. The bed is completely made of melamine faced chipboard with ABS edging. A ladder is set on one of the sides.</p> <p>The mattress is held on a raw chipboard, mounted on a subconstruction that is fastened to the bed frame.</p> <p>During the research, beds of the same size and structure as the abovementioned, but with different designs, were found.</p>	

4.4.4. Storage furniture





In the Table 18 are described all types of storage furniture found in observed polygons.

4. POLYGONS, SAMPLES, RESPONDENTS AND RESEARCH METHODS





Table 18 Types of storage furniture by polygons

TYPE	DESCRIPTION	PHOTO
LOCATION I		
a1	<p>Storage 1-piece furniture with three horizontal fixed shelves for storing didactic materials. The corpus consists of a ceiling, lower and rear elements, left and right sides and of a base.</p> <p>It is used angle hardware for fastening, single-sided groove system and fastening element.</p> <p>The corpus is made of beech laminated wood, widely glued.</p>	
a2	<p>Storage furniture for storing didactic materials that consists of 2 segments, interconnected by piano hinges, around which they rotate. The element can be open in space (top photo) or closed (bottom photo). Each segment is three-partial, with 1 fixed shelf on one side and 3 fixed shelves on the other. The corpus consists of a ceiling, bottom and rear elements, left and rightside, mounted on castors (wheels).</p> <p>The elements are interconnected with a fixed edge- end connection, with a single-sided groove system and a fastening element.</p> <p>The body is made of beech laminated wood, widely glued.</p>	
a3	<p>Storage 2-piece double-layer furniture with a fixed shelf for storing children's personal clothes. The corpus consists of a ceiling, lower element, rear element, left and right sides and 2 doors.</p> <p>It's used angle hardware for fastening, with wooden dowels.</p> <p>The corpus is made of melamine faced chipboard, with ABS edging.</p>	
a4	<p>Storage 1-piece furniture with 3 fixed shelves for storing children's personal clothes. The corpus consists of a ceiling, lower, rear, left and right sides, which lie directly on the lower element.</p> <p>It's used angle hardware for fastening, with wooden dowels.</p> <p>The corpus is made of melamine faced chipboard, with ABS edging.</p>	






4. POLYGONS, SAMPLES, RESPONDENTS AND RESEARCH METHODS

a5	<p>Storage 1-piece double-layered furniture, used for storing the children's beds. The corpus consists of a ceiling, lower element, rear element, left and right sides and 2 doors. Above this element there is a 40 cm extension for storing bedding.</p> <p>It's used angle hardware for fastening, with wooden dowels.</p> <p>The corpus is made of melamine faced chipboard, with ABS edging. One cabinet can accommodate 6 beds.</p>	
a6	<p>Storage furniture with shelves for storing didactic staf. It consists of 3 fixed shelves and 6 vertical sidewalls. The corpus is shaped like a pyramid, with stepped rectangular shelves that lie on a base of 10 cm.</p> <p>It's used angle hardware for fastening, with wooden dowels.</p> <p>The corpus is made of melamine faced chipboard, with ABS edging.</p>	
a7	<p>Storage 2-piece double-layer furniture with 1 horizontal fixed shelf for storing children's personal clothes. The corpus consists of a ceiling, floor, back, left and right panels, 2 doors and of a base of 10 cm.</p> <p>It's used angle hardware for fastening, with wooden dowels.</p> <p>The corpus is made of melamine faced chipboard, with ABS edging.</p>	
a8	<p>Two pieces- open shelves cabinet in the upper part and door closed lower part. The corpus is consisted of two open shelves and lower element with two doors. Two sides left and right.</p> <p>It's used angle hardware for fastening, with wooden dowels.</p> <p>The corpus is made of melamine faced chipboard, with ABS edging.</p>	






4. POLYGONS, SAMPLES, RESPONDENTS AND RESEARCH METHODS

a9	<p>Storage 3-piece furniture with 3 vertical fixed shelves and 1 fixed vertical fixed shelf for storing didactic aids and toys. The corpus consists of a ceiling, floor, back, left and right panels. 2 doors and of a base of 10 cm. There are 3 doors at the bottom.</p> <p>It's used angle hardware for fastening, with wooden dowels.</p> <p>The corpus is made of melamine faced chipboard, with ABS edging.</p>	
LOCATION II		
b1	<p>Storage 2-piece furniture with 2 horizontal fixed shelves for storing didactic materials. The body consists of a ceiling, floor, back, left and right panels.</p> <p>It's used angle hardware for fastening, with wooden dowels.</p> <p>The corpus is made of melamine faced chipboard, with ABS edging.</p> <p>Many examples of this type of furniture have been found in polygon II, which are of different sizes, shapes and colours.</p>	
b2	<p>Storage 1-piece furniture with 2 horizontal fixed shelves for storing didactic materials. The corpus consists of a ceiling, floor, back, left and right panels.</p> <p>The element is mounted on a base, which makes it fixed.</p> <p>It's used angle hardware for fastening, with wooden dowels.</p> <p>The corpus is made of melamine faced chipboard, with ABS edging.</p> <p>Many pieces of this type of furniture have been found in polygon II, which are of different sizes.</p> <p>Many examples of this type of furniture have been found in polygon II, which are of different sizes, shapes and colours.</p>	
b3	<p>Storage 5-piece furniture with 6 wings for storing children's personal clothes. The corpus consists of a ceiling, floor, back, left and right panels that are directly screwed to the wall.</p> <p>It's used angle hardware for fastening, with wooden dowels. There is a hook attached to the bottom.</p> <p>The corpus is made of laminated solid beech wood.</p>	

4. POLYGONS, SAMPLES, RESPONDENTS AND RESEARCH METHODS


b4	<p>Storage 3-piece furniture with 1 horizontal fixed shelf and 4 doors for storing children's personal clothes. The corpus consists of a ceiling, floor, back, left and right panels and of a base of 10 cm.</p> <p>It's used angle hardware for fastening, with wooden dowels.</p> <p>The body is made of melamine faced chipboard with ABS edging.</p>	
b4a	<p>Storage furniture, the same as type b4 in polygon II has been found in many variants and it differs dimensionally and with slight differences in shape.</p> <p>The lockers on the upper photo are of one segment.</p>	
b5	<p>Storage 3-part furniture with 2 vertical cross-sided and 2 horizontal sidewalls for storing didactic materials and toys. The corpus consists of a ceiling, floor, left and right panels.</p> <p>The element is on wheels and is in the shape of a quarter circles. The corpus is on castors (wheels).</p> <p>It's used angle hardware for fastening, with wooden dowels. The body is made of melamine faced chipboard with ABS edging.</p>	
b6	<p>Storage furniture with shelves for storing didactic materials. The corpus consists of floor and back panels. The semicircular shelves and back panel give the furniture a pear shape.</p> <p>It's used angle hardware for fastening, with wooden dowels. The body is made of melamine faced chipboard with ABS edging.</p>	
b7	<p>Storage furniture with shelves for storing didactic materials. The corpus consists of ceiling, floor, back, left and right panels. There are plastic boxes on the shelves for sorted storage. The corpus is mounted on a base or on castors (wheels).</p> <p>It's used angle hardware for fastening, with wooden dowels. The body is made of melamine faced chipboard with ABS edging. Many examples of this type of furniture have been found in polygon II, which are of different sizes, shapes and colours.</p>	

4. POLYGONS, SAMPLES, RESPONDENTS AND RESEARCH METHODS

b8	<p>Storage furniture for storing children's personal clothes. The body consists of two columns with four lockers each. Between the columns there are two horizontal shelves of which the lower serves as a bench and the upper as a hanger.</p> <p>It's used angle hardware for fastening, with wooden dowels. The body is made of melamine faced chipboard with ABS edging.</p>	
b9	<p>Storage 1-piece furniture with two fixed horizontal shelves for storing didactical aids and toys. The body consists of a ceiling, floor, left and right panels.</p> <p>The element is on castors, which enables the possibility of storing didactical aids both from the front and the back.¹⁵</p> <p>It's used angle hardware for fastening, with wooden dowels. The body is made of melamine faced chipboard with ABS edging.</p>	
LOCATION III		
c1	<p>Storage 3-piece furniture with 3 horizontal fixed shelves and with 6 doors for storing didactic aids and toys. The corpus consists of a ceiling, floor, back, left and right panels and of a base.</p> <p>It's used angle hardware for fastening, with wooden dowels. The body is made of melamine faced chipboard with ABS edging.</p>	
c2	<p>Storage furniture with 2 horizontal fixed shelves for storing children's personal clothes. The body consists of a ceiling, floor, back, left and right panels and 2 doors.</p> <p>It's used angle hardware for fastening, with wooden dowels. The body is made of melamine faced chipboard with ABS edging.</p>	
3	<p>Storage 3-doors furniture with 2 vertical fixed shelves and 1 or 2 vertical fixed sidewalls, for storing didactical aids and toys. The corpus consists of ceiling, floor, back, left and right panels and legs. There are 3 doors at the bottom.</p> <p>It's used angle hardware for fastening, with wooden dowels. The body is made of melamine faced chipboard with ABS edging.</p>	

¹⁵In a conversation with the teachers from polygon II. it has been pointed out by them that they consider this element of furniture to be one of the most functional according to its constructive solution. This is due to the ability to manipulate, the position of the wheels and the ability to store from both sides, front and rear.

4. POLYGONS, SAMPLES, RESPONDENTS AND RESEARCH METHODS

c4	Storage furniture with fixed shelves or doors for storing didactic items, toys, or office materials. The body consists of ceiling, floor, back, left and right panels. It's used angle hardware for fastening, with wooden dowels. The body is made of melamine faced chipboard with ABS edging.	
c5	Storage furniture with fixed shelves or doors for storing didactic items, toys or office materials. The corpus consists of ceiling, floor, back, left and right panels. It's used angle hardware for fastening, with wooden dowels. The body is made of melamine faced chipboard with ABS edging.	
c6	Storage furniture with two horizontal fixed shelves and two vertical sides for storing didactic material. The corpus consists of of ceiling, floor, back, left and right panels. It's used angle hardware for fastening, with wooden dowels. The body is made of melamine faced chipboard with ABS edging.	

4.5. PARTICIPANTS (RESPONDENTS)

Participants in the research were from all three locations. Research has been implemented in several different stages. The research was done with preschool children first. Talking to teachers, parents, principals and persons in charge of preschools employed in municipalities and other institutions, it was decided that the best and safest way is to examine, measure and photograph children in the premises where they reside. In the next stage, a survey was conducted with the preschool employees (teachers) in all three locations Skopje, Zagreb and Sofia. Part of the research was conducted at the Faculty of Forestry and Wood Technology in Zagreb, the Institute of Furnishings and Wood Products, at the Lesotechnical University in Sofia, the Faculty of Furniture Design and Technologies in Skopje.

Other respondents that are directly or indirectly involved in issues that deal with preschool furniture in kindergartens, such as the City Office of Education in Zagreb, Sofia Municipality, Municipality of Centar, Municipality of Butel and City of Skopje in Skopje have been included to achieve the research objective; manufacturers and distributors of preschool

furniture in the countries surveyed; the Non Government Organization "Step by Step" in Zagreb and Skopje that represents and implements creative and innovative teaching processes;

The research included following participants:

- Preschool children:
 - a) through anthropometric measurements;
 - b) using a mosaic method;
- Employed in kindergartens: through a survey;
- Producers/distributors: through a survey.

4.5.1. Participants - children in anthropometric measurements

Anthropometric measurements included a total of 848 pre-school children, of which 446 boys and 406 girls. For the needs of the research, the children from certain pre-school institutions in Skopje, Zagreb and Sofia were selected precisely from the largest nursery group (children from 2 years) from the small group (3-4 years), the medium group (4-5 years), the large group (5-6 years) and children from the pre-school group (children 6-7 years). The youngest child at the time of the measurement was 2 years and 2 months old and the oldest was 7 years and 6 months old. The distribution of children by gender and age group is shown in the Table 19.

All the children who have been included in the measurement were healthy and showed no symptoms of pain in the back, neck, or some form of malformation in the musculoskeletal system. None of the participants had previously participated in this type of study. Data for each polygon, and the number of children who participated in the anthropometric measurements has been shown in the Table 20.

Children older than 7 years are in the same group as children aged 6 - 7, due to easier data processing.

Table 19 Distribution of children by age groups

Location	Skopje						
	2-3 years	3-4 years	4-5 years	5-6 years	6-7 years	total	Total per gender
Boys	17	23	47	59	/	146	51,9 %
Girls	15	16	50	54	/	135	49,1 %
Total per groups (N)	32	39	97	113	/	281	100 %
Total per groups	11,4 %	13,9 %	34,5 %	40,2 %	/	100 %	

4. POLYGONS, SAMPLES, RESPONDENTS AND RESEARCH METHODS

Location	Zagreb						
	2-3 years	3-4 years	4-5 years	5-6 years	6-7+ years	total	Total per gender
Boy	12	34	36	36	37	155	55,1 %
Girl	12	28	31	28	27	126	44,9 %
Total per groups (N)	24	62	67	64	64	281	100 %
Total per groups	8,5 %	22,1 %	23,8 %	22,8 %	22,8 %	100 %	
Location	Sofia						
years/ group	2-3 years	3-4 years	4-5 years	5-6 years	6-7+ years	total	Total per gender
Boy	2	25	33	40	45	145	50,7
Girl	/	27	43	25	46	141	49,3
Total per groups (N)	2	52	76	65	91	286	100 %
Total per groups	0,7 %	18,2 %	26,6 %	22,7 %	31,8 %	100 %	
Total I II III Location	2-3 years	3-4 years	4-5 years	5-6 years	6-7+ years	total	Total per gender
Boy	31	82	116	135	82	446	52,6 %
Girl	27	71	124	107	73	402	47,4 %
Total per groups (N) I II III Location	58	153	240	242	155	848	100 %
Total per groups I II III Location	6,8 %	18,1 %	28,3 %	28,5 %	18,3 %	100 %	

* In the Republic Macedonia since 2008, according to the Law on Primary Education, children from 6 to 7 years enter the education process of primary schools, not the pre-school process as before (***, 2013).

Table 20 Distribution of respondents to preschool children by polygons

location	Name of the polygon	Age group	Boy	Girl	Total	Total per polygon
I Skopje, Republic of North Macedonia	Majski cvet	2-3 years	/	/	/	38
		3-4 years	/	/	/	
		4-5 years	12	6	18	
		5-6 years	3	11	20	
	11-ti Oktomvri	2-3 years	1	/	1	63
		3-4 years	4	2	6	
		4-5 years	11	14	25	
		5-6 years	15	16	31	
	Kocho Racin	2-3 years	7	8	15	85
		3-4 years	10	9	19	
		4-5 years	9	16	25	
		5-6 years	14	12	26	
	Tashko Karadza	2-3 years	9	7	16	74
		3-4 years	9	5	14	
		4-5 years	11	9	20	
		5-6 years	15	9	24	
	13-ti Noemvri	2-3 years	/	/	/	21
		3-4 years	/	/	/	
		4-5 years	4	5	9	
		5-6 years	6	6	12	
Total			140	135	281	

4. POLYGONS, SAMPLES, RESPONDENTS AND RESEARCH METHODS

II Zagreb, Republic of Croatia	Različak, Petrinjska str.	2-3 years	/	/	/	72
		3-4 years	9	6	15	
		4-5 years	11	11	22	
		5-6 years	16	9	25	
		6-7+ years	6	4	10	
	Špansko, Špansko str.	2-3 years	9	10	19	95
		3-4 years	11	13	24	
		4-5 years	9	9	18	
		5-6 years	8	9	17	
		6-7+ years	12	5	17	
	Različak, Jurišićeva str.	2-3 years	2	/	2	30
		3-4 years	3	/	3	
		4-5 years	3	2	5	
		5-6 years	3	4	7	
		6-7+ years	7	6	13	
	Trešnjevka, Badalićeva str.	2-3 years	1	2	3	84
		3-4 years	11	9	20	
		4-5 years	13	9	22	
		5-6 years	9	6	15	
		6-7+ years	12	12	24	
Total		155	126	281		
III Sofia, Republic of Bulgaria	Bratya Mormarevi	2-3 years	/	/	/	127
		3-4 years	5	6	11	
		4-5 years	14	17	31	
		5-6 years	19	10	29	
		6-7+ years	21/ ¹⁶	21/7	42/14	
	Moyat Sviat	2-3 years	/	/	/	91
		3-4 years	4	3	7	
		4-5 years	8	15	23	
		5-6 years	21	13	34	
		6-7+ years	8/6	12/1	20/7	
	Zdrave	2-3 years	2	/	2	19
		3-4 years	6	8	14	
		4-5 years	1	2	3	
		5-6 years	/	/	/	
		6-7+ years	/	/	/	
	Brezichka	2-3 years	/	/	/	22
		3-4 years	10	9	19	
		4-5 years	3	/	3	
		5-6 years	/	/	/	
		6-7+ years	/	/	/	
	Slance	2-3 years	/	/	/	19
		3-4 years	/	1	1	
		4-5 years	7	9	16	
		5-6 years	/	2	2	
		6-7+ years	/	/	/	
	Zornica	2-3 years	/	/	/	8
3-4 years		/	/	/		
4-5 years		/	/	/		
5-6 years		/	/	/		
6-7+ years		3	5	8		
Total		145	141	286		

¹⁶The first number is for children of 6-7 years and the second for children 7 years before going to school. Children at the age of 7 join this group for further easier processing of data.

4.5.2. Participant in survey methods

4.5.2.1. Kindergarten employees in survey method

A total of 593 respondents, mostly teachers (caretakers and teachers), and the rest of the kindergarten staff participated in the survey. The research was done in all three locations, In Table 8 is shown how many and which kindergartens were included in this survey. Kindergarten employees are divided by the type of work responsibilities and years of work experience, not by gender and age. Distribution of respondents-employees (N) and percentage by job position and years of work experience are shown in Tables 21 and 22.

Table 21 Distribution of respondents – teachers: by job position

Polygon	City	Respondent	Total (N)	Total (%)
I	Skopje	Caretaker (teacher)	121	54,6 %
		educator	93	42,1 %
		Other staff		
		speech therapist	1	0,5 %
		administration	2	0,9 %
		special educator	1	0,5 %
		principal	2	0,9 %
		pedagogue	1	0,5 %
		total	221	100 %
II	Zagreb	Teacher	167	97,5 %
		Other staff		
		Psychologist	1	0,5 %
		nurse	2	1 %
		special educator	1	0,5 %
		pedagogue	1	0,5 %
		Total	172	100 %
III	Sofia	Teacher	143	71,5 %
		Assistant educator	35	17,5 %
		Other staff		
		pedagogue	4	2 %
		Principal	5	2,5 %
		nurse	7	3,5 %
		Accountant	4	2 %
		Psychologist	1	0,5 %
		Janitor	1	0,5 %
		Total	200	100 %

Table 22 Years of work experience of respondents – kindergarten employees

question/answers	number (proportion) of answers			P	n (%)
	Skopje	Zagreb	Sofia		Total
Work experience in years					
do 5	59 (26.6)	22 (15.0)	40 (20.3)	0.01*	121 (21.4)
6-10	35 (15.8)	29 (19.7)	26 (13.2)		90 (15.9)
11-15	27 (12.2)	12 (8.2)	20 (10.2)		59 (10.4)
16-20	25 (11.3)	12 (8.2)	17 (8.6)		54 (9.5)
21-30	37 (16.7)	26 (17.7)	28 (14.2)		91 (16.1)
More than 30	39 (17.6)	46 (31.3)	66 (33.5)		151 (26.7)

4.5.2.2. Producers / distributors in survey method

In the survey of producers / distributors are involved 12 company from Croatia, North Macedonia and Bulgaria. The Table 23 provides basic data of respondents, company name, number of employees and type of bussines.

Table 23 Producers/distributors and basic characteristics

No.	company name	year of founded	number of employees	type of bussines
1	Astreja plus d.o.o. Zagreb	1999	10	Import and sale of final products
2	Sliv oprema d.o.o. Zagreb	1992	3	Import of furniture parts, installation and sale of final products
3	TEDING d.o.o. Zagreb	1990	20	Production of furniture, wood products and semi-finished wood products
4	Škrinjica d.o.o. Zagreb	1994	8	Import and sale of final products
5	Karat-M Skopje	-	40	Production of furniture, products and semi-finished wood products
6	Andrej Kompani Skopje	2016	7	Production of furniture, products and semi-finished wood products
7	Mebel Art Skopje	2009	30	Production of furniture, products and semi-finished wood products
8	Tri Max Skopje	2000	41	Import and sale of final products
9	Kan Uchtehsport O. O. D. Sofia	1992	100	Production of furniture, products and semi-finished wood products
10	TES -A mebeli Sofia	1994	3	Import and sale of final products
11	Bulgarska uchilishna industria OOD Sofia	2007	14	Production of furniture, products and semi-finished wood products
12	Dibo mebeli Sofia	1997	80	Production of furniture, products and semi-finished wood products

4.5.3. Participants - children in Mosaic method

This study involved 36 preschool children (19 boys and 17 girls) aged 5 to 7 years, from the one polygon in the Zagreb. All participants were in a healthy mental state, with no signs of any deficiencies. None of the children had previously participated in any research of this type.

4.5.4. Participants - children in the method of observation and photographing

Participants - children were observed and photographed at all three locations in all polygons (Table 9).

5. RESULTS

In this chapter, the research results are processed and divided into four sections:

- 5.1. Results of the measurements of samples and participants,
- 5.2. Results of surveys,
- 5.3. Results of mosaic method study,
- 5.4. Photographs of the participants, preschool children, and the samples.

Each section contains comments on the obtained results, as the introduction to the Discussion chapter.

5.1. RESULTS OF THE MEASUREMENTS OF SAMPLES AND PARTICIPANTS

5.1.1. Results from measuring furniture

The results of measuring furniture are given in the tables and the text below, for each type of furniture separately.

In each of the three locations, furniture has been found that differs according to construction-design solution, functional dimensions, materials used and colour. Many types of furniture of have been noted separately, but only those that appear more frequently or are necessary for performing some activity in the preschool institution are analyzed in results.

5.1.1.1. Results of chairs' measurements

A total of 36 types of chairs have been analyzed that are included in the research, marked with capital letters A to Z in Table 13. Only chairs used by preschool children are analyzed.

The chairs used in kindergartens differed in several aspects:

i) Functional purpose: According to their functional purpose, they are divided into: chairs (A, C, D/D1, E, F, G, I/I1, N/N1/N2/N3, P/P1/P2, R/R1, R2, S, T, U/U1, V, X, Y, Z), chairs with armrests (B, K, L), stools (J), sofas (J1, W), armchairs (M) and children's high chairs (with tray) (H, O).

ii) Upholstery: Depending on whether the seat and/or the backrest had upholstery, the seating furniture is divided to non-upholstered (A, B, C, D/D1, E, F, G, I/I1, K, L, N/N1/N2/N3, P/P1/P2, R/R1, R2, S, T, U/U1, V, X,) or upholstered (H, J/J1, M, O, W, Y, Z).

iii) Adjusting: According to the construction, elements for seating are fixed on all chairs. Nor one has the possibility of adjusting the height, i.e. changing the dimensions.

iv) Mobility: According to mobility, all the chairs were movable. Mobility is divided into immobile, mobile and easily mobile (with castors) (Kychukov, 2004).

v) Materials used:

- Solid wood chairs and wood materials, composed of:

Two fronts legged with rectangular (D/D1, E, G, H, I/I1, K, T, V, Z) or square (A, B, L, N/N1/N2/N3, U/U1) cross section, with circular cross section (C, F, O, P/P1/P2, R/R1, R2, S, X, Y), made of solid wood, with diameter of 25 to 40 mm, width from 30 to 50 mm.

Two rear legs with same cross sections, with thickness/diameter of 25 to 40 mm and width of 30 to 55 mm.

The seat is made of veneer press with a thickness of 6 to 7 mm. The shape is rectangular, with a rounded form in the upper part of a certain type of chairs. It is with a slight inclination forward and rounded front edge, for help when tilting the body forward. On certain seats there is an indentation that follows the buttocks line, for a more comfortable seating (C, D/D1, G, I, K, N/N1/N2/N3, P/P1/P2, R/R1, R2).

The seat is usually attached to a carrying subconstruction and is connected either directly to it or with the help of a seat frame made up of seat rails, screwed or glued together. The seat rails with the front and rear legs are joined with a feather and groove, with dowels or with glue. Some of the chairs have side or front stretchers/spindles (C, O, U/U1, V), which are connected to the legs by the feather and groove, or with dowels with gluing. They are either lateral that connect the front and back legs or are only front or only rear.

The backrest is made of veneer press from 6 to 10 mm. The shape is rectangular with rounded edges. It is set to the height for the upper back, while for the lumbar part lacks the backrest. With all types of chairs, it has a semicircular shape (in the top view) to follow the line of the back. The backrest is fixed to the carriers that are connected to the seat rails or to the rear legs that are extended and

perform the function of holders. On the backrest area there was also a backrest composed of a top rail (upper back rail) and mid rail (C, O, P). The reinforcement of this type of backrest with the stile is with a feather and groove.

The armrests are made of veneer press and they enter the construction of the skeleton of the chair as an extension of the legs.

- Chairs of non-wood materials, made of plastic substances, polypropylene. They are made of one detail, i.e., casted in one press (F, G, S, T).

vi) Dimensions: The functional dimensions of the chairs are given in Table 24 and each is measured and marked according to EN 1729-1:2015. Note that chair size 3 were measured without school chair measurement device (SCMD).

Table 24 The functional dimensions of the chairs

Location	type of chair	Dimensions in cm									marking	user guide
		height of seat	width of seat	effective depth of seat	width of backrest	height of backrest	Inclination of seat	Angle between	height of armrest above the seat	width between armrests		
		h8	b3	t4	b4	h7	α	γ	p	r		
Location I	A	35	30	30	33	13	-5°	101°	/	/	Yes	/
	B	27	30	28	32	12,5	-5°	100°	8	40	/	/
	C	29	33	30	29	4	5°	95°	/	/	/	/
	D	29	30	30	32	12	-3°	95°	/	/	/	/
	D1	34	33,5	33	35	12	-3°	95°	/	/	/	/
	E	34	33	33	35	12	0°	95°	/	/	/	/
	F	27/30	30	30	30	13	0°	93°	/	/	/	/
	G	35,5	43	38	43	27,5	-5°	100°	/	/	/	/
	H	24	30	25	30	27	0°	105°	13	30	/	/
	J	31	35	40	/	/	0°	/	/	/	/	/
	J1	32	73	35	73	24	0°	90°	/	/	/	/
Location II	I	34	31,8	34	31,5	10	0°	95°	/	/	/	/
	II	25	25,5	26,5	22,5	10	0°	95°	/	/	/	/
	K	29	29	27	30,5	15	0°	113°	9	29	/	/
	L	27	30	26,6	31	27	(-) 3°	95°	13,3	31	/	/
	M	32,5	37,5	32,5	37,5	24,5	0°	90°	15,5	37,5	/	/
	N,	35,	32,	30,	33,5	15,						
	N1,	33,	27,	26,	32,	14,	-3°	101°	/	/	/	/
	N2,	31,	28,	26,	29,	13,						
N3	25,	27	30	26	12							
O	35	30	25.2	30	26	0°	90°	13	30	/	/	

	P,	34,	36,	33,	30,	17,						
	P1,	30,	32,	30,	27,	15,	-3 ⁰	96 ⁰	/	/	/	/
	P2	25	28	26	24	14						
	R,	35,	34,	29,	35,	14,						
	R1,	34,	34,	34,	35,	14,	-3 ⁰	95 ⁰	/	/	/	/
	R2	30	28	27	29	14						
	S	22.5	29	25	29	49	0 ⁰	100 ⁰	5	31	/	/
Location III	T	30	31	25	31	30	0 ⁰	105 ⁰	/	/	/	/
	U	35	29	28,5	29	10	0 ⁰	90 ⁰	/	/	/	/
	U1	29	27	26	29	10	0 ⁰	91 ⁰	/	/	/	/
	V	30,5	24	29	22	4	0 ⁰	90 ⁰	/	/	/	/
	W	37	60, 120	32	60, 120	35	0 ⁰	93 ⁰	/	/	/	/
	X	28,5	28	29	32	13	0 ⁰	100 ⁰	/	/	/	/
	Y	32	28	23	29	22	0 ⁰	94 ⁰	/	/	/	/
	Z	32	28	29	28	32	-3 ⁰	97 ⁰	12	29	/	/

5.1.1.2. Results of tables' measurements

A total of 22 types of tables were analyzed, marked with an ordinal number from 1 to 22 (Table 16).

Tables in all observed kindergartens are used for many different functions: eating, writing, reading, playing, or performing a given task.

Various types of tables were found during the research, which differ according to the shape, construction, dimensions, use of materials and color.

i) Adjusting: According to the possibility of changing the dimensions, there were found tables with the option to adjust the height of the worktops (types 1, 2 and 8). The regulation of the tables of types 1 and 2 is made possible with a system located on the legs, composed of two metal bars which enter (slip) into each other. The lower bar that is movable has a small protruding part and enters the upper bar that is fixed and has holes. At the desired height, the protruding part of the bottom bar enters the hole of the upper one. At the table type 8, the height is regulated with adjusting screwed on the bottom part of the legs.

Tables that alter the dimensions according to the collection or assembly principle were found only in Polygon II, type 12. The worktop consists of a rectangular and two semicircular tops. The semicircular tops are joined with "piano hinges" on the rectangular plate, which is held by two movable metal bars that pull back and forth. When the metal bars are pulled in, the semicircular tops fold down, making the table decrease in dimensions.

ii.) Mechanisms: Tables that have mechanisms for stretching the tops in width or length, as well as a mechanism for changing the angle of the worktop, were not found.

iii.) Shape: Depending on the *shape of the worktop*: rectangular (type 3, 5, 6, 8, 9, 13, 16, 17, 18a, 19, 20, 22a), circular (type 2, 4, 7, 11, 14, 15, 18b), semicircular, 19b), trapezoidal (type 1, 22c) and a combination of multiple forms (type 10, 22b). The worktop is with overhang on all (four) sides, i.e. bigger than the subconstruction underneath. They are made of boards with a thickness of 18 and 25 mm. The worktop of the tables is made of plywood boards covered with melamine paper in several patterns and colors.

iv.) Mobility: According to the mobility, the tables that are divided into immovable, movable and easily movable tables with wheels (Kjuchukov, 2004). All types of tables are movable.

v.) Materials: According to the materials used, tables are made of solid wood, wooden materials, non-wooden materials, and a combination of materials.

v.i. Tables of solid wood and wooden materials:

- Legs made of veneer press and worktop made of melamine faced chipboard edges with solid wood (3, 17) and ABS edging (5)
- Legs made of solid wood and worktop with melamine faced chipboard edges with solid wood (5, 6, 9, 10,) or ABS trim (11)
- Legs made of solid wood with multi plywood panels (18)
- Legs made of veneer press and worktop made of MDF boards (4)
- Table completely made of melamine faced chipboard panels (20)

v.ii. Tables made of non-wooden materials, made of plastic substances (8, 15).

v.iii. Table made of a combination of multiple materials:

- Metal legs and chipboard worktop, edge-trimmed with solid wood edging (12, 13, 14) or ABS edging (1, 2, 16, 19, 21, 22).
- Plastic legs and plywood worktop (7).

vi.) Construction: In terms of construction, the tables have been designed in the following manner:

- Tables on which the legs are connected with the screws to the worktop, without carrier construction (1, 2, 7, 8, 15, 20, 21, 22).
- Tables with a carrier subconstruction of metal bars in the form of a rectangle, welded together and screwed to the worktop (12, 13, 14, 15).

- Tables with a carrier subconstruction of solid detail rails, connected with fixed connection with dowels and glue (5, 6, 9, 10 - semicircular dowel, 11)
- A vertical sub construction of veneer press, where the legs themselves make up the construction. They are composed of a single veneer press that forms the letter 'P' (3, 4).

During the analysis of the tables, in none of them was found footrest.

vii.) Colors: In terms of color, the tables are all different. The legs most often retain the natural appearance of the material, if they are from wooden materials – solid beech wood/beech veneer, and if they are made of metal - the colour finish. The most of worktops are in the range of white and beige tones, while those of MDF are painted in bright colors, red, green, blue, or yellow.

viii.) Dimension: The functional dimensions of the tables are given in table 25 and each is measured and marked according to EN 1729-1:2015.

Table 25 Functional dimensions of tables

Location	Type of table	Dimensions (in mm)									marking	user guide
		height of table top	depth of table top	width of top, per person at front edge, where pupils sit	Width of top surface	Surface area per person (min)	legroom	Height of footrest	inclination of the table top	vertical distance between the top of the table and the top of the seat		
		h1	t1	w1	b1		h2, h4, t2,t3	h9	y	z		
Location I	1	56	156/76	74	74	0,1406 m2	/	/	/	21	/	/
	2	51	37	58	ø74	0,107 m2	/	/	/	16	/	/
	3	50	80	80	80	0,16m2	/	/	/	15	/	/
	4	50	45	70,65	ø90	0,1589m2	/	/	/	15	/	/
	5	50	80	80	80	0,16m2	/	/	/	15	yes	/
	6	50	90	45	90	0,135m2	/	/	/	15	/	/
	7	52	40	62,8	ø80	0,1256	/	/	/	22	/	/
	8	52	62	62	62	0,0961	/	/	/	16,5	/	/
Location II	9	58	90	45	90	1,0125	/	/	/	24	/	/
	10	58	45	70,65	ø90	0,1589m2	/	/	/	24	/	/
	11	48	45	70,65	ø90	0,1589m2	/	/	/	21	/	/
	12	52	80/30	40/ 35	60, ø60	0,1271	/	/	/	18	/	/
	13	50	80	80	80	0,16m2	/	/	/	16	/	/
	14	54	60	47,1	ø120	0,1413	/	/	/	19	/	/
	15	54	57	44,745	ø114	0,1275	/	/	/	22	/	/
	16	56	61	61	122	0,062	/	/	/	21	/	/
	17	49	90	90	90	0,2025	/	/	/	22	/	/
	18	57	90/70	45/54,95	90 ø140	0,10125/ 0,1623	/	/	/	23	/	/
Location III	19	56	100	50	50	0,083	/	/	/	26	/	/
	20	52	100	50	60	0,15	/	/	/	22	/	/
	21	56	100	50	50	0,15	/	/	/	26	/	/
	22	52	100/30	50/35	60	0,15/0,127	/	/	/	21,5	/	/

5.1.1.3. Results of beds' measurements

In all polygons, 11 types of beds were found (Table 17). There were no beds in some kindergartens in Location II. Children sleep on mattresses placed directly on the floor. All beds in all locations are single, of which a smaller part are bunk beds in Location III.

Beds are divided into two groups. They differ structurally and according to shape:

- a) Beds for children aged 2 to 7 (A1, B2, C1, C2 / C2a, C3, C5) and
- b) beds for nursery group (A2, A3, C4).

i.) Materials: According to the materials from which the beds are made, they are made of wood and wooden materials, namely:

- Beds made of laminated steamed beech (A1). This type of bed is kept all the time in specially designed bed-locker. Structurally, the bed is composed of two side rails, whit veener plywood joined with a tenon and groove.
- Beds made of melamine faced chipboard (C1, C2, C3, and C5). Regarding construction, all are made up of a headboard, footboard and right and left sides. At certain type of beds, the height of all structural elements is of the same dimension, while in another type of beds the headboard and one of the side boards are higher. At a third type, the headboard and footboard are higher than the sideboards. The bed base is made of melamine faced chipboard. They lie on solid wood beams embedded in the sides of the bed.
- Beds made from a combination of wood and wooden materials. The beds are made up of the same elements as the above mentioned, with the difference that they are higher and have the form of a fence, to perform a safety function. One of the types of these beds has the possibility of regulating the height of the side rails for easier manipulation when lifting or putting back the child. The side with slats are mostly made of turned wood elements.
- Beds made of combination of plastic and metal (B2)

ii.) Dimensions: The functional dimensions are given in the following table 26.

Table 26 Functional dimensions of beds

location	type of bed	dimensions (in mm)						fold-up bed
		height	width	depth	height of upper bed	height of side rails	height of headboard and footboard	
		H	B	L	L1	H1	h7	
I	A1	25	130	50	/	5	/	yes
	A2	30	120	60	/	80	80	/
	A3	30	120	60	/	80	80	/
II	B1	/	/	/	/	/	/	/
	B2	12	133	12	/	/	/	/
III	C1	30	140	60	100	15	15	/
	C1a	20	140	60	83	15	40	/
	C2	30	140	60	/	15/40	40/15	/
	C3	30	140	70	/	15/40	40/16	/
	C4	30	110	60	/	70	70	/
	C5	20	140	70	100	20	45	/

5.1.1.4. Results of Storage furniture' measurements

A total of 25 different types of storage furniture were analyzed. In each polygon types were marked with a small alphabet letter and an ordinal number (Table 18).

i.) Purpose: According to the purpose, the storage furniture can be divided into:

- for the storage of didactic materials and toys (a1, a6, a9, b2, b1, b6, b7, b9, c1, c4, c5, c6),
- for storage of personal belongings of the children (a3, a4, a7, b3, b4, b4a, b8, c2, c2a) and
- for storing books, picture books and writing material (a2, a8, b2, b5, c1, c3, c4, c5).

Only elements of furniture exclusively used by children have been considered.

ii.) Mobility: According to mobility, the elements are immovable, whose body is held on a toekick (the sides take on the role of the legs, and a mask is installed on the front), or legs and easily moved on castors. Depending on the type of material, the legs are made of solid wood or metal. A standalone toekick is used, which a construction is made of melamin faced chipboard in the form of a box.

iii.) Structure: all types of storage furniture were composed of left and right side, top, bottom panels and rear (back) panel. In some cases, the back element does not exist when it comes to furniture that separates the space and is used on both sides (b5, b9). Apart from the basic structural elements of which each piece of furniture is composed, depending on the function, other elements are added as well.

According to constructions, they can divide it into (the division according Gruevski and Simakovski, 2003)

- Cabinet with open shelves (a1, a2, a4, a6, b1, b2, b5, b6, b9, c6),
- Cabinet with doors. Small doors that open by turning around a vertical axis (a3, a5, a7, b3, b4, b4a, b8, c2),
- Cabinet with drawers and pull-out boards (b7),
- Combined furniture of open shelves, doors, and drawers (a8, a9, c1, c3, c4, c5).

Depending on the vertical inter-sides, the fixed shelves, and the number of doors, the storage furniture can be divided:

- According to the number of vertical inter-sides, into one-part, two-part, three-part, and multi-part furniture,
- Furniture without, with one, two, three or more horizontal sides,
- According to the number of small doors, into one door, two doors, and three doors cabinets.

iv.) Dimensions: Constructive joints that are commonly used in this furniture are various screws types that are directly screwed without pre-made joints or glue. This connection also appears as an additional one, for reinforcing the construction. Another type of connection is a fixed connection with glued dowels or semi-groove and dowel. The functional dimensions are given in Table 27.

Table 27 Functional dimensions of storage furniture

location	type of cabinet furniture	description	dimension (in mm)					
			height	width	depth	Height of toe kick	Height between shelves	height of the highest shelf
			H	S	D	h1	h2	h3
location I	a1	shelves	132,5	91	25	5	27	103
	a2	shelves	36	68	36	7	30	68
	a3	wardrobe	126	33	35	10	/	100
	a4	wardrobe	139	35	35	/	20	111
	a5	cabinet for beds	150	100	60	10	/	150
	a6	shelves	120	280	35	10	40	80
	a7	wardrobe	133- 147	30- 40	34- 42	10	20- 30	80- 100
	a8	shelves with drawers	122	80	30	5	/	100
	a9	shelves with wings	131	151	41	10	50/26	102
location II	b1	shelves with wheels	56	102	40	7	16	48
	b2	shelves with wheels	78/76	90/100	38,5/42	10	20/18	58/62
	b3	wardrobe	40	22	30	/	/	108
	b4	wardrobe	100	35	35	10	10	100
	b4a	wardrobe	120/65	26/31	40	10	20	88/110

	b5	shelf with wheels	95	147	40	7	43	95
	b6	Shelves	130	100	38	5	30	102
	b8	wardrobe	30	26	40	/	40	92
	b9	shelves with wheels	60	10	35	7	17	48
location III	c1	shelves with wings	139	165	39	10	41	91
	c2	wardrobe	104- 112	22- 26	32- 38,5	2- 10.	15- 20	84-90
	c3	shelves with wings	94	120	38	10	21,5	73,5
	c4	shelves with wings	200- 240	30-120	60	10	various	200
	c5	Shelves	50- 150	50- 120	30-055	5-10,	various	various
	c6	Shelves	127	80	35	5	40	80

5.1.2. Results of children's anthropometric measurements

The anthropometric measurements included a total of 848 kindergarten children. The share of children was equally distributed (Chi-Square Test, $P=0.98$) between all three polygons (Chart 1).

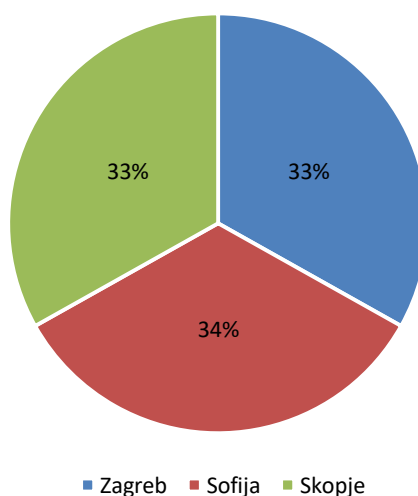


Chart 1 Share of children between investigated location

The study included preschool children of both sexes (Chi-Square Test, $P=0.29$), i.e. 446 (52.6 %) boys and 402 (47.4 %) girls children. There is no significant difference (Chi-Square Test, $P=0.44$) in age between genders, meaning that in almost every age category there was similar percentage of both genders (Chart 2).

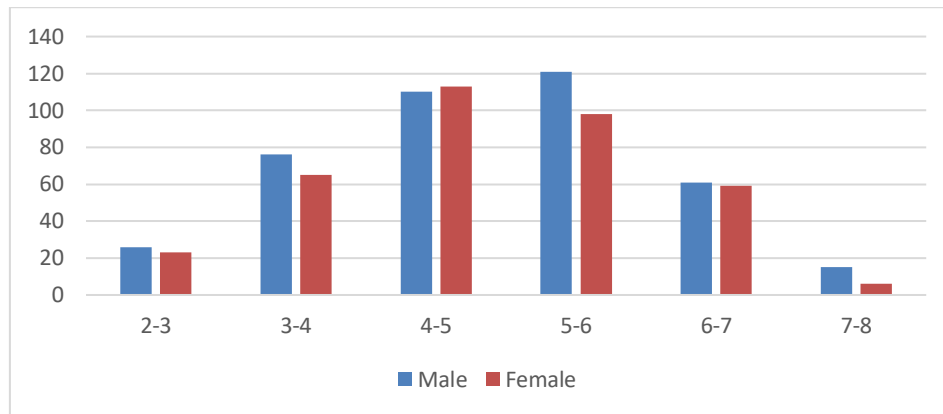


Chart 2 Frequency regarding age differences among children between gender

It is also common to omit the more extreme values of anthropometric measurements because furniture is designed for the general population. It is common to take the 5th and 95th percentile of the distribution and omit up to 5% of the data on both sides of the distribution (Panero and Zelnik, 1990). In this research, 8.8% of extreme data is left out (N=75=848-773).

5.4.1.1. Differences between genders

Statistical significance in anthropometric parameters among children regarding gender was found in almost every age group in head height (Mann-Whitney U Test, $P < 0.001$), while concerning other anthropometric parameters, no differences were found. (Tables 28 - 33).

In average the head height measure is significantly higher among male children comparing to the female children (Chart 3). In age between three and four, male children were found to be significantly heavier ($P=0.04$) than female children. For children in age between four and five, boys have significantly ($P=0.01$) shorter upper leg length i.e. buttock-popliteal length. Also, boys, when in age between five and six are significantly taller both when standing ($P=0.02$) and taller in sitting height ($P=0.02$) and also have significantly ($P=0.007$) larger width from elbow to elbow than girls ones.

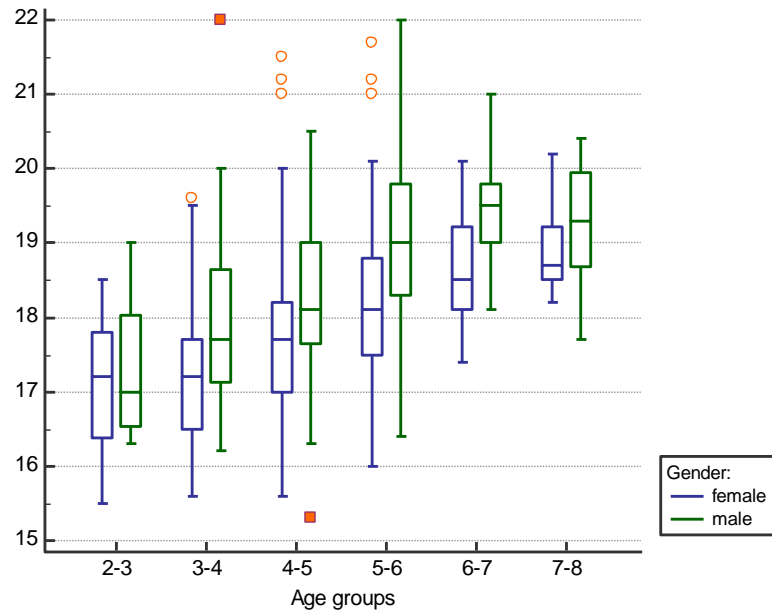


Chart 3 Differences in Head height regarding gender between children of different age

Table 28 Differences in anthropometric parameters regarding gender (in age between 2-3)

Variable (all in cm, except weight kg)	symbol	median (IQR)		P*
		Male (n=26)	Female (n=23)	
stature	(A)	97.5 (92.7 - 99.4)	94.5 (92.6 - 97.1)	0.15
height to the eye	(B)	88.4 (84.6 - 90.1)	85.8 (82.5 - 87.6)	0.09
maximum reach	(C)	112.9 (107.5 - 114.5)	109.2 (104.0 - 112.6)	0.27
sitting height	(D)	52.6 (50.8 - 54.2)	52.1 (50.3 - 54.3)	0.50
upper leg length, buttock to knee	(E)	28.9 (27.7 - 29.9)	28.3 (27.4 - 29.9)	0.78
knee height, seated	(G)	28.4 (26.8 - 29.5)	27.5 (26.9 - 28.7)	0.32
popliteal height, seated	(H)	23.6 (21.8 - 24.2)	22.9 (22.0 - 23.9)	0.41
upper leg length, buttock-popliteal length, seated	(F)	23.5 (22.5 - 24.5)	23.1 (22.1 - 24.2)	0.46
shoulder height	(I)	33.4 (32.7 - 34.2)	32.6 (31.8 - 34.8)	0.35
shoulder width	(J)	25.3 (23.9 - 25.9)	24.5 (24.1 - 25.5)	0.43
width from elbow to elbow	(K)	27.2 (24.9 - 28.4)	25.9 (24.7 - 27.8)	0.19
hip breadth, maximum when seated	(L)	20.7 (20.2 - 21.7)	20.5 (20.0 - 21.7)	0.66
elbow height	(P)	13.7 (12.9 - 14.2)	13.8 (12.8 - 14.7)	0.56
lumbar height	(N)	15.4 (14.2 - 15.9)	14.8 (14.1 - 16.2)	0.89
head height	(O)	17.0 (16.5 - 18.1)	17.2 (16.3 - 17.9)	0.82
weight	(M)	14.9 (13.7 - 16.3)	15.0 (13.2 - 16.7)	0.86

*Mann-Whitney U Test

Table 29 Differences in anthropometric parameters regarding gender (in age between 3-4)

Variable (all in cm, except weight kg)	symbol	median (IQR)		P*
		Male (n=76)	Female (n=65)	
stature	(A)	101.8 (100.5 - 105.5)	101.9 (99.4 - 104.7)	0.38
height to the eye	(B)	92.2 (90.3 - 95.1)	92.3 (89.5 - 94.9)	0.44
maximum reach	(C)	120.5 (117.8 - 124.1)	120.4 (116.4 - 124.3)	0.36
sitting height	(D)	55.5 (54.0 - 56.9)	55.0 (53.4 - 56.5)	0.29
upper leg length, buttock to knee	(E)	31.2 (29.9 - 32.1)	31.3 (30.5 - 32.3)	0.21
knee height, seated	(G)	30.2 (29.5 - 31.5)	30.3 (29.4 - 31.5)	0.77
popliteal height, seated	(H)	24.9 (24.1 - 25.9)	24.9 (24.3 - 25.9)	0.82
upper leg length, buttock- popliteal length, seated	(F)	25.2 (24.5 - 26.5)	25.6 (24.7 - 26.5)	0.48
shoulder height	(I)	35.4 (33.5 - 36.8)	35.0 (34.1 - 36.8)	0.87
shoulder width	(J)	26.1 (25.2 - 27.0)	25.6 (25.0 - 26.8)	0.28
width from elbow to elbow	(K)	28.2 (26.8 - 29.5)	28.1 (26.4 - 29.1)	0.49
hip breadth, maximum when seated	(L)	21.9 (21.4 - 23.0)	22.1 (21.1 - 23.1)	0.96
elbow height	(P)	14.0 (13.4 - 14.8)	14.2 (13.3 - 14.8)	0.93
lumbar height	(N)	16.0 (15.5 - 16.9)	15.9 (15.3 - 16.3)	0.29
head height	(O)	17.7 (17.1 - 18.7)	17.2 (16.5 - 17.7)	<0.001
weight	(M)	16.9 (15.4 - 18.5)	16.2 (14.7 - 17.5)	0.04

*Mann-Whitney U Test

Table 30 Differences in anthropometric parameters regarding gender (in age between 4-5)

Variable (all in cm, except weight kg)	symbol	median (IQR)		P*
		Male (n=110)	Female (n=113)	
stature	(A)	107.6 (104.5 - 110.5)	106.6 (103.8 - 111.0)	0.37
height to the eye	(B)	97.5 (94.5 - 100.9)	97.1 (93.4 - 100.8)	0.29
maximum reach	(C)	128.4 (123.7 - 133.5)	127.5 (122.9 - 133.4)	0.42
sitting height	(D)	57.2 (55.3 - 59.7)	57.1 (55.5 - 58.7)	0.42
upper leg length, buttock to knee	(E)	33.0 (31.9 - 34.3)	33.4 (32.2 - 34.9)	0.13
knee height, seated	(G)	32.3 (31.4 - 33.7)	32.5 (30.9 - 34.1)	0.93
popliteal height, seated	(H)	26.8 (25.5 - 27.9)	26.9 (25.8 - 28.5)	0.17
upper leg length, buttock- popliteal length, seated	(F)	26.6 (25.6 - 28.1)	26.9 (26.2 - 28.8)	0.01
shoulder height	(I)	36.1 (34.5 - 37.5)	36.6 (35.1 - 37.9)	0.06
shoulder width	(J)	26.3 (25.6 - 27.5)	26.3 (25.4 - 27.5)	0.75
width from elbow to elbow	(K)	28.1 (26.2 - 29.5)	28.1 (26.1 - 28.8)	0.27
hip breadth, maximum when seated	(L)	22.5 (22.1 - 23.5)	22.4 (22.3 - 23.5)	0.14
elbow height	(P)	14.2 (13.5 - 15.4)	14.3 (13.5 - 15.1)	0.98
lumbar height	(N)	16.6 (15.9 - 17.6)	16.6 (15.8 - 17.5)	0.82
head height	(O)	18.1 (17.6 - 19.0)	17.7 (17.0 - 18.2)	0.001
weight	(M)	18.3 (16.8 - 19.8)	17.9 (16.2 - 20.1)	0.56

*Mann-Whitney U Test

Table 31 Differences in anthropometric parameters regarding gender (in age between 5-6)

Variable (all in cm, except weight kg)	symbol	median (IQR)		P*
		Male (n=121)	Female (n=98)	
stature	(A)	115.6 (112.3 - 118.4)	113.8 (110.3 - 117.3)	0.02
height to the eye	(B)	105.5 (102.1 - 107.8)	104.1 (101.2 - 107.5)	0.06
maximum reach	(C)	139.6 (135.2 - 144.2)	136.8 (132.5 - 142.7)	0.02
sitting height	(D)	61.2 (59.4 - 63.4)	60.2 (58.5 - 62.8)	0.15
upper leg length, buttock to knee	(E)	36.2 (34.9 - 37.6)	35.8 (34.7 - 37.4)	0.44
knee height, seated	(G)	35.6 (34.4 - 37.4)	35.3 (33.3 - 36.7)	0.12
popliteal height, seated	(H)	29.5 (28.5 - 30.4)	29.5 (27.9 - 30.3)	0.45
upper leg length, buttock- popliteal length, seated	(F)	29.5 (28.5 - 30.5)	29.3 (28.2 - 30.5)	0.20
shoulder height	(I)	39.2 (37.4 - 40.8)	39.0 (36.6 - 40.9)	0.92
shoulder width	(J)	27.8 (27.2 - 29.5)	27.7 (26.9 - 28.5)	0.11
width from elbow to elbow	(K)	29.5 (27.5 - 31.1)	28.5 (26.9 - 30.1)	0.007
hip breadth, maximum when seated	(L)	23.5 (22.6 - 24.5)	23.4 (22.3 - 24.5)	0.26
elbow height	(P)	15.2 (14.4 - 16.4)	15.5 (14.5 - 16.5)	0.23
lumbar height	(N)	17.5 (16.4 - 18.9)	17.9 (16.7 - 19.5)	0.12
head height	(O)	19.0 (18.3 - 19.8)	18.1 (17.5 - 18.8)	<0.001
weight	(M)	20.7 (19.2 - 23.4)	20.4 (18.0 - 22.3)	0.10

*Mann-Whitney U Test

Table 32 Differences in anthropometric parameters regarding gender (in age between 6-7)

Variable (all in cm, except weight kg)	symbol	median (IQR)		P*
		Male (n=61)	Female (n=59)	
stature	(A)	122.6 (118.0 - 125.3)	121.9 (119.6 - 125.0)	0.96
height to the eye	(B)	112.2 (107.4 - 115.8)	112.3 (109.4 - 115.1)	0.96
maximum reach	(C)	149.4 (143.7 - 154.8)	147.4 (144.4 - 153.3)	0.58
sitting height	(D)	65.2 (62.4 - 66.4)	64.8 (62.6 - 66.7)	0.98
upper leg length, buttock to knee	(E)	38.6 (36.8 - 41.1)	39.4 (37.8 - 40.8)	0.29
knee height, seated	(G)	38.1 (36.5 - 39.7)	38.4 (37.1 - 39.7)	0.52
popliteal height, seated	(H)	30.9 (29.7 - 32.0)	31.2 (30.3 - 32.4)	0.23
upper leg length, buttock- popliteal length, seated	(F)	31.4 (29.9 - 32.4)	31.7 (30.6 - 33.2)	0.13
shoulder height	(I)	42.2 (40.4 - 43.3)	42.2 (40.5 - 43.5)	0.60
shoulder width	(J)	29.7 (28.5 - 30.6)	29.3 (28.2 - 30.5)	0.41
width from elbow to elbow	(K)	31.6 (30.6 - 32.7)	31.1 (29.5 - 32.9)	0.12
hip breadth, maximum when seated	(L)	24.5 (23.6 - 26.1)	24.4 (23.5 - 25.3)	0.46
elbow height	(P)	15.8 (15.1 - 16.8)	16.1 (15.4 - 16.6)	0.84
lumbar height	(N)	17.9 (16.9 - 18.5)	17.9 (17.3 - 18.5)	0.83
head height	(O)	19.5 (19.0 - 19.8)	18.5 (18.1 - 19.3)	0.001
weight	(M)	24.0 (21.7 - 27.2)	22.8 (20.8 - 25.7)	0.11

*Mann-Whitney U Test

Table 33 Differences in anthropometric parameters regarding gender (in age between 7-8)

Variable (all in cm, except weight kg)	symbol	median (IQR)		P*
		Male (n=15)	Female (n=6)	
stature	(A)	124.6 (120.4 - 127.6)	125.6 (117.8 - 130.4)	0.68
height to the eye	(B)	114.3 (110.4 - 117.5)	115.6 (108.0 - 120.4)	0.73
maximum reach	(C)	153.4 (147.5 - 158.7)	153.1 (141.8 - 163.5)	>0.99
sitting height	(D)	66.7 (64.8 - 67.4)	65.4 (60.2 - 68.3)	0.73
upper leg length, buttock to knee	(E)	39.9 (38.7 - 40.9)	41.5 (39.4 - 42.4)	0.38
knee height, seated	(G)	39.1 (37.5 - 40.3)	39.9 (38.0 - 40.8)	0.38
popliteal height, seated	(H)	31.2 (30.3 - 32.8)	32.1 (30.2 - 33.5)	0.68
upper leg length, buttock- popliteal length, seated	(F)	31.7 (30.5 - 32.9)	33.7 (31.8 - 34.6)	0.18
shoulder height	(I)	44.4 (42.1 - 45.3)	44.8 (42.5 - 46.1)	0.68
shoulder width	(J)	29.3 (28.2 - 30.8)	29.9 (27.4 - 30.8)	0.79
width from elbow to elbow	(K)	31.4 (30.8 - 33.1)	31.9 (30.9 - 33.3)	0.47
hip breadth, maximum when seated	(L)	24.7 (23.4 - 25.8)	24.8 (23.9 - 26.0)	0.73
elbow height	(P)	16.9 (15.4 - 17.8)	15.9 (15.0 - 16.5)	0.17
lumbar height	(N)	18.5 (17.7 - 18.9)	17.8 (16.5 - 19.7)	0.42
head height	(O)	19.3 (18.6 - 20.0)	18.7 (18.4 - 19.6)	0.45
weight	(M)	23.9 (22.4 - 27.7)	23.6 (20.7 - 29.2)	0.80

*Mann-Whitney U Test

5.4.1.2. Differences between polygons in anthropometric parameters

There is significant difference (Chi-Square Test, $P < 0.001$) found in age between children measured in different cities' kindergarten. In Skopje there is higher percentage of younger children comparing to the Sofia and Zagreb, where there is higher percentage of the older ones (Chart 4).

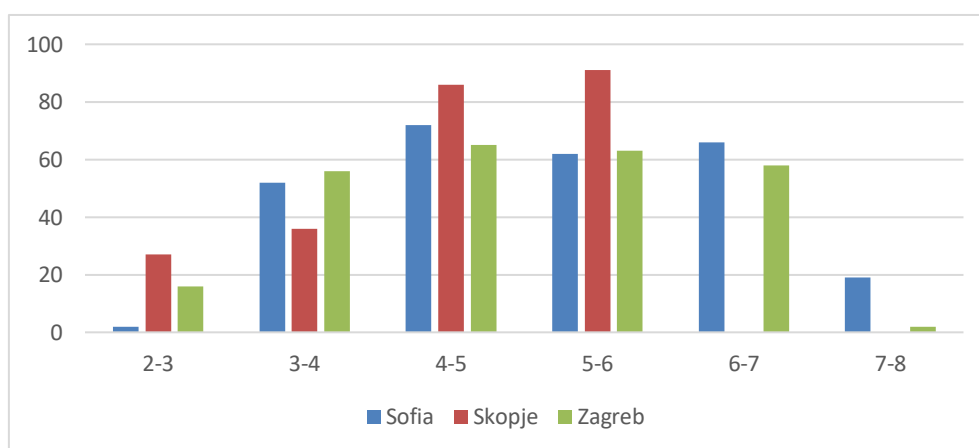


Chart 4 Frequency of the children's age between cities

Generally, significant differences were found in most of the measured anthropometric parameters between children from different polygons (Tables 34 - 38). Although, due to the comparison of anthropometric parameters between children, it was necessary to divide them into age groups because of the large difference in parameters between children of different ages,

the conclusions were, as far as possible, generalized. Therefore, these differences need to be considered when designing furniture and certainly when defining a standard, so the following results are generally pointed out for all kindergarten children.

In most age groups, most parameters that somehow measure height are on average significantly higher among children from Location I. These are the following parameters:

- stature
- height to the eye
- head height (chart 3)
- maximum reach (chart 5)
- popliteal height (chart 6)
- knee height (chart 7)
- lumbar height
- elbow height, seated

On average, the width of the buttocks is significantly the highest among kindergarten children from Location I (Chart 9). That means that the children in Location I seem to be taller than the children from Location II and III!

No significant difference was found in the average length of the upper leg, except for ages 4-5 where it was significantly shorter among Sofia children ($P < 0.001$).

Kindergarten children from Sofia, on average, have a significantly higher sitting height (Chart 10) and on average have the widest shoulders compared to kindergarten children from the other two observed cities. Kindergarten children in Zagreb have, on average, a significantly longer buttock-popliteal length (Chart 8), but on average have the lowest shoulder height compared to kindergarten children in the other two cities.

Table 34 Differences between anthropometric parameters regarding polygons (in age between 2-3)

Variable (all in cm, except weight kg)	Median (IQR)		P*
	Skopje (n=27)	Zagreb (n=15)	
stature (A)	97.2 (94.6 - 99.5)	96.2 (91.9 - 98.9)	0.27
height to the eye (B)	88.2 (85.8 - 90.1)	87.3 (82.8 - 89.7)	0.25
maximum reach (C)	111.8 (108.2 - 114.5)	112.2 (106.7 - 115.9)	0.67
sitting height (D)	52.4 (51.0 - 55.2)	52.4 (50.5 - 54.5)	0.51
upper leg length, buttock to knee (E)	28.9 (28.1 - 29.6)	28.6 (27.8 - 30.5)	0.77
knee height, seated (G)	28.3 (27.5 - 29.1)	28.3 (26.8 - 29.7)	0.98
popliteal height, seated (H)	23.3 (22.9 - 24.2)	23.4 (22.1 - 24.2)	0.75
buttock-popliteal length, seated (F)	23.5 (22.4 - 24.1)	23.9 (23.0 - 25.1)	0.10
shoulder height (I)	33.6 (32.5 - 35.7)	33.5 (32.5 - 34.5)	0.57
shoulder width (J)	25.2 (24.3 - 26.1)	25.1 (24.3 - 25.9)	0.67
width from elbow to elbow (K)	25.2 (23.8 - 27.9)	28.1 (26.5 - 28.4)	0.03
hip breadth, maximum when seated (L)	21.1 (20.3 - 21.8)	20.9 (20.2 - 21.8)	0.71
elbow height (P)	14.3 (13.8 - 15.1)	12.9 (12.0 - 13.8)	<0.001
lumbar height (N)	15.6 (14.3 - 16.5)	14.5 (13.9 - 15.3)	0.04
head height (O)	17.9 (17.0 - 18.4)	16.8 (16.4 - 17.6)	0.08
Weight (M)	15.4 (14.3 - 16.8)	15.0 (13.2 - 16.8)	0.36

*Mann-Whitney U Test

Table 35 Differences between cities/polygons regarding anthropometric parameters (in age between 3-4)

Variable (all in cm, except weight kg)	Median (IQR)			P*
	Sofia (n=52)	Skopje (n=36)	Zagreb (n=56)	
stature (A)	101.5 (99.6 - 103.7)	103.5 (100.4 - 106.5)	101.5 (100.4 - 104.2)	0.12
height to the eye (B)	91.6 (89.5 - 93.6)	93.7 (90.8 - 95.8)	91.5 (89.8 - 94.3)	0.03
maximum reach (C)	120.0 (116.5 - 122.7)	122.2 (118.5 - 125.4)	119.8 (116.6 - 124.1)	0.12
sitting height (D)	56.4 (54.6 - 57.6)	55.4 (54.1 - 56.7)	54.6 (53.0 - 56.0)	0.002
upper leg length, buttock to knee (E)	31.2 (30.2 - 32.2)	31.2 (30.2 - 32.2)	31.3 (30.2 - 32.2)	0.79
knee height, seated (G)	30.2 (29.5 - 30.9)	31.3 (29.5 - 32.1)	30.2 (29.5 - 31.4)	0.11
popliteal height, seated (H)	24.7 (24.1 - 25.1)	25.4 (24.8 - 26.3)	25.1 (24.1 - 26.2)	0.02
upper leg length, buttock-popliteal length, seated (F)	25.2 (24.4 - 25.9)	25.5 (24.8 - 26.1)	25.9 (24.8 - 26.8)	0.02
shoulder height (I)	35.8 (34.6 - 37.5)	35.5 (34.4 - 37.5)	34.3 (32.4 - 36.4)	<0.001
shoulder width (J)	26.2 (25.1 - 27.2)	26.2 (25.2 - 27.3)	25.5 (24.8 - 26.4)	0.03
width from elbow to elbow (K)	28.2 (26.9 - 29.1)	24.5 (23.1 - 24.5)	28.5 (27.4 - 29.8)	<0.001
hip breadth, maximum when seated (L)	21.7 (21.1 - 22.7)	22.5 (21.6 - 23.5)	22.1 (21.3 - 23.1)	0.009
elbow height (P)	14.5 (13.6 - 14.9)	14.5 (13.8 - 15.9)	13.5 (13.3 - 14.2)	<0.001
lumbar height (N)	16.3 (15.8 - 16.9)	16.5 (15.5 - 17.4)	15.5 (14.9 - 15.9)	<0.001
head height (O)	17.0 (16.4 - 17.3)	18.4 (17.8 - 19.1)	17.6 (17.0 - 18.0)	<0.001
Weight (M)	16.1 (14.8 - 17.5)	16.9 (15.3 - 19.0)	16.8 (15.1 - 18.1)	0.14

*Kruskal-Wallis Test

Table 36 Differences between cities/polygons regarding anthropometric parameters (in age between 4-5)

Variable (all in cm, except weight kg)	Median (IQR)			P*
	Sofia (n=72)	Skopje (n=86)	Zagreb (n=65)	
stature (A)	105.2 (102.4 - 108.4)	108.4 (105.6 - 112.3)	109.1 (106.1 - 111.5)	<0.001
height to the eye (B)	95.0 (92.2 - 98.3)	97.8 (95.7 - 102.2)	98.9 (95.5 - 101.4)	<0.001
maximum reach (C)	125.5 (121.6 - 131.2)	129.8 (123.7 - 133.7)	129.8 (126.2 - 133.8)	0.002
sitting height (D)	57.4 (56.4 - 59.6)	56.5 (54.9 - 58.5)	56.6 (55.3 - 59.5)	0.06
upper leg length, buttock to knee (E)	32.2 (31.5 - 33.4)	33.5 (32.2 - 35.3)	33.9 (32.6 - 34.7)	<0.001
knee height, seated (G)	31.4 (30.3 - 32.3)	33.4 (32.1 - 35.1)	32.5 (31.5 - 34.1)	<0.001
popliteal height, seated (H)	25.8 (24.9 - 26.6)	27.9 (26.5 - 29.4)	27.4 (26.3 - 28.0)	<0.001
upper leg length, buttock-popliteal length, seated (F)	26.1 (25.5 - 26.9)	27.0 (25.9 - 28.8)	27.8 (26.8 - 28.8)	<0.001
shoulder height (I)	36.5 (35.3 - 37.8)	36.4 (35.1 - 37.9)	35.6 (34.1 - 37.6)	0.11
shoulder width (J)	26.2 (25.5 - 27.1)	26.9 (25.5 - 28.1)	26.3 (25.6 - 27.2)	0.04
width from elbow to elbow (K)	28.2 (27.5 - 28.5)	25.5 (24.2 - 28.1)	28.8 (28.1 - 29.7)	<0.001
hip breadth, maximum when seated (L)	22.1 (21.2 - 22.8)	23.3 (22.5 - 24.2)	22.3 (21.6 - 23.2)	<0.001
elbow height (P)	14.3 (13.9 - 15.2)	14.4 (13.3 - 15.4)	14.2 (13.5 - 15.2)	0.76
lumbar height (N)	16.4 (15.8 - 16.9)	17.6 (16.5 - 19.5)	16.1 (15.5 - 16.8)	<0.001
head height (O)	17.5 (16.9 - 17.8)	18.8 (17.7 - 19.6)	17.9 (17.6 - 18.5)	<0.001
Weight (M)	17.1 (16.1 - 19.2)	19.6 (17.5 - 21.0)	18.3 (16.9 - 19.6)	<0.001

*Kruskal-Wallis Test

Table 37 Differences between cities/polygons regarding anthropometric parameters (in age between 5-6)

Variable (all in cm, except weight kg)	Median (IQR)			P*
	Sofia (n=62)	Skopje (n=91)	Zagreb (n=63)	
stature (A)	113.7 (111.4 - 117.2)	115.7 (113.3 - 119.8)	114.5 (110.1 - 117.6)	0.01
height to the eye (B)	103.6 (101.4 - 107.3)	105.7 (102.6 - 108.5)	104.5 (99.8 - 107.5)	0.02
maximum reach (C)	138.2 (132.9 - 143.4)	140.3 (135.5 - 144.7)	136.8 (132.4 - 143.4)	0.03
sitting height (D)	61.4 (59.6 - 63.6)	61.0 (59.1 - 64.1)	60.1 (57.5 - 61.9)	0.02
upper leg length, buttock to knee (E)	36.2 (34.2 - 37.3)	36.4 (35.1 - 37.9)	35.6 (34.8 - 36.6)	0.11
knee height, seated (G)	35.0 (33.4 - 36.1)	36.5 (34.5 - 37.8)	35.0 (33.8 - 36.4)	<0.001
popliteal height, seated (H)	28.8 (27.1 - 29.5)	29.9 (29.1 - 31.5)	29.4 (28.4 - 30.1)	<0.001
upper leg length, buttock-popliteal length, seated (F)	29.3 (27.7 - 30.4)	29.4 (28.5 - 30.8)	29.3 (28.6 - 30.4)	0.23
shoulder height (I)	39.0 (37.8 - 40.6)	40.2 (37.4 - 41.4)	37.6 (35.8 - 39.5)	<0.001
shoulder width (J)	27.6 (27.2 - 29.2)	28.1 (27.1 - 29.5)	27.5 (26.9 - 28.3)	0.22
width from elbow to elbow (K)	30.1 (28.6 - 31.1)	27.1 (24.8 - 29.9)	29.8 (29.1 - 31.0)	<0.001
hip breadth, maximum when seated (L)	23.5 (22.6 - 24.2)	24.1 (22.8 - 25.5)	23.2 (22.3 - 23.9)	0.002
elbow height (P)	15.2 (14.5 - 15.9)	15.6 (14.5 - 16.8)	15.3 (14.1 - 15.8)	0.04
lumbar height (N)	17.3 (16.6 - 18.1)	19.3 (17.9 - 21.2)	16.7 (15.9 - 17.5)	<0.001
head height (O)	18.4 (17.7 - 18.8)	19.5 (18.4 - 20.0)	18.0 (17.5 - 19.0)	<0.001
Weight (M)	20.0 (18.5 - 22.3)	21.1 (19.2 - 25.7)	20.2 (19.0 - 21.7)	0.01

*Kruskal-Wallis Test

Table 38 Differences between cities/polygons regarding anthropometric parameters (in age between 6-7)

Variable (all in cm, except weight kg)	Median (IQR)		P*
	Sofia (n=66)	Zagreb (n=58)	
stature (A)	122.4 (119.3 - 125.1)	122.4 (118.1 - 125.2)	0.92
height to the eye (B)	112.3 (109.0 - 115.9)	112.7 (107.6 - 115.8)	0.82
maximum reach (C)	149.7 (145.0 - 154.4)	146.8 (143.3 - 151.6)	0.08
sitting height (D)	65.5 (63.5 - 67.2)	64.2 (61.8 - 65.8)	0.004
upper leg length, buttock to knee (E)	39.8 (38.5 - 41.2)	38.2 (36.5 - 40.1)	0.009
knee height, seated (G)	38.5 (37.2 - 39.7)	37.9 (36.5 - 39.6)	0.27
popliteal height, seated (H)	31.2 (29.8 - 32.2)	31.1 (29.9 - 32.2)	0.75
upper leg length, buttock-popliteal length, seated (F)	31.7 (30.6 - 33.1)	31.1 (29.9 - 32.4)	0.14
shoulder height (I)	42.2 (40.5 - 43.4)	41.8 (40.4 - 43.4)	0.33
shoulder width (J)	30.2 (28.6 - 30.9)	29.2 (27.9 - 30.3)	0.02
width from elbow to elbow (K)	31.4 (30.3 - 32.7)	31.3 (30.0 - 33.0)	0.75
hip breadth, maximum when seated (L)	24.5 (23.6 - 25.2)	24.3 (23.5 - 26.4)	0.57
elbow height (P)	15.6 (14.9 - 16.6)	16.2 (15.5 - 16.8)	0.06
lumbar height (N)	17.9 (17.2 - 18.5)	18.0 (17.2 - 18.5)	0.98
head height (O)	19.1 (18.3 - 19.7)	19.0 (18.4 - 19.8)	0.74
Weight (M)	23.8 (22.2 - 27.1)	22.6 (21.1 - 26.6)	0.27

*Mann-Whitney U Test

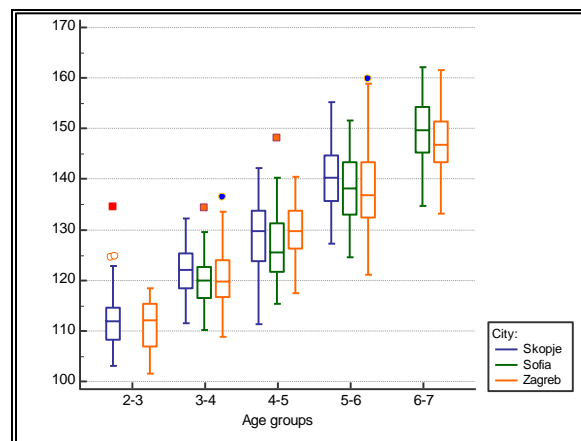


Chart 5 Maximum reach in height between age group in locations

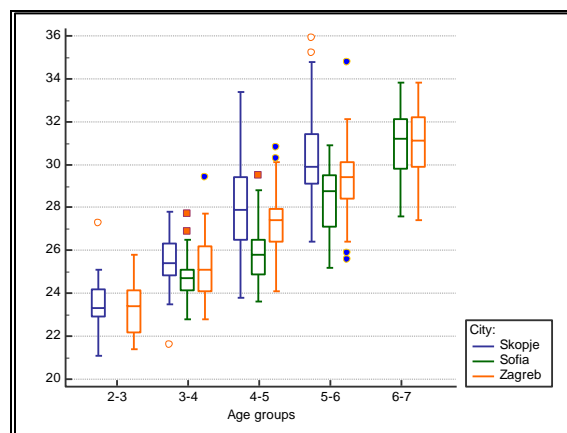


Chart 6 Popliteal height between age group in locations

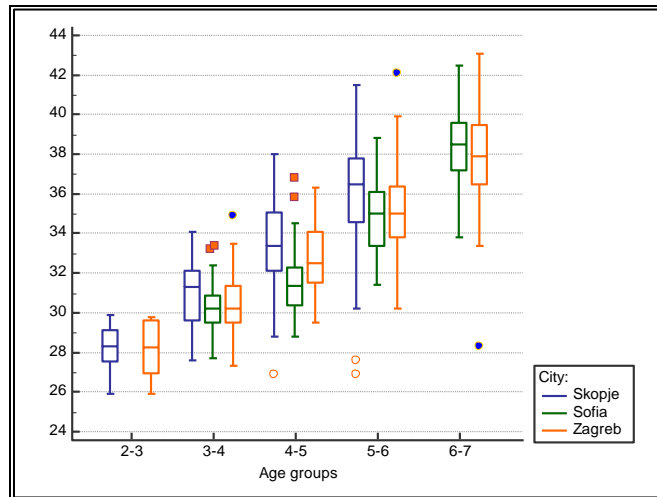


Chart 7 Knee height between age group in locations

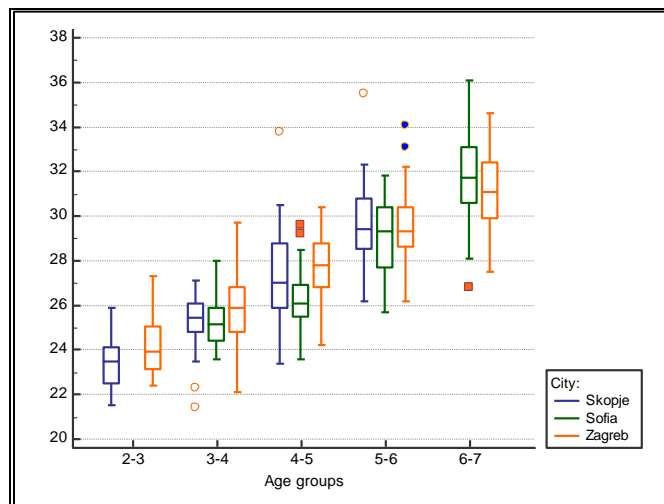


Chart 8 Upper leg height, buttock - popliteal length between age group in locations

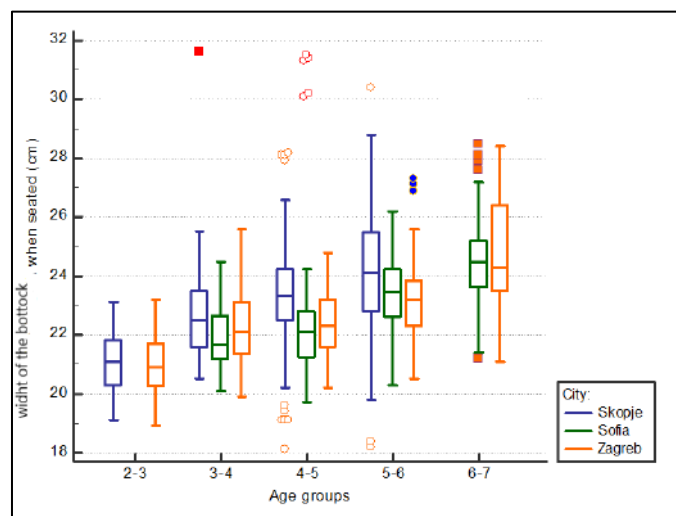


Chart 9 Width of the buttocks (seated) between age group in locations

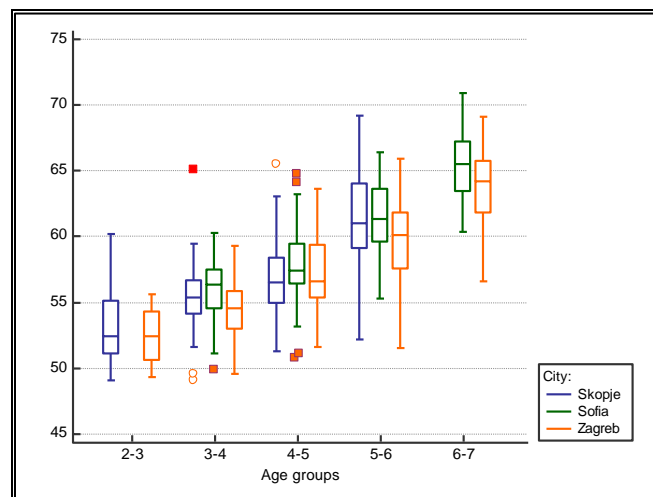


Chart 10 Sitting height between age group in locations

5.1.3. Comparison of furniture dimensions and standard

The comparison is made on all chairs and tables that are processed with the standard EN 1729-1:2015, in Tables 24 and 25. The comparison helps determine whether the measured dimensions correspond to the standard, whether the furniture is marked and has an instruction for use and whether it corresponds to the height differences between children.

With red color and "underline" indicator (Tables 39 and 40), the inconsistency and deviation from the norm are indicated, expressed in cm. In large part, chairs and tables do not correspond to the prescribed standard.

Note: Chairs marked as size 3 in the standard should be measured by special measuring device aimed for this purpose or in certified laboratories. In this case, these chairs were not measured as required by the EN due to the different polygons in which the research had been carried out and the inability to measure them in the laboratory. They are not left out of the analysis due to the fact that they are present in the facilities. Unlike chairs marked as size 3, other size mark: 0, 1 and 2 can be measured in classical way.

Table 39 Comparison of types of chairs with EN 1729-1:2015

chair type	size to which it belongs according to EN 1729- 1: 2015	Dimensions (in mm), deviation from the normal dimension within the norm EN of default tolerance								marking							
		height of seat	width of seat	effective depth of seat	width of backrest	height of backrest	Inclination of seat	Angle between the seat and the backrest	height of armrest above the seat	width between armrests	color and size according to group	manufacturer	year	instruction			
		h8	b3	t4	b4	h7	α	γ	p	r							
location I	A	3	+10	-20									n/a	+	n/a	n/a	
	B	1	+10	+60									n/a	n/a	n/a	n/a	
	C	<u>1</u>	<u>+30</u>	+90									n/a	n/a	n/a	n/a	
	D	<u>1</u>	<u>+30</u>	+60									n/a	n/a	n/a	n/a	
	D1	3	-10	+15									n/a	n/a	n/a	n/a	
	E	3	-10	+10									n/a	n/a	n/a	n/a	
	F	1	+10	+60									n/a	n/a	n/a	n/a	
	G	3	+05	+110									n/a	n/a	n/a	n/a	
	H	<u>2</u>	<u>-20</u>	+20									n/a	n/a	n/a	n/a	
	J	2	+	+70									n/a	n/a	n/a	n/a	
	J1	2	+10	/									n/a	n/a	n/a	n/a	
location II	I	3	+10	-02									n/a	n/a	n/a	n/a	
	II	1	-10	+15									n/a	n/a	n/a	n/a	
	K	<u>1</u>	<u>+30</u>	+50									n/a	n/a	n/a	n/a	
	L	1	10	+60									n/a	n/a	n/a	n/a	
	M	<u>2</u>	<u>+1.5</u>	+95									n/a	n/a	n/a	n/a	
	N, N1	3	+	+									n/a	n/a	n/a	n/a	
	N2	<u>3</u>	<u>-20</u>	-10													
	N3	2	+	+													
	N3	<u>1</u>	-10	+30													
	O	3	+	-20										n/a	n/a	n/a	n/a
	P	3	-10	+40										n/a	n/a	n/a	n/a
	P1	2	-10	+40										n/a	n/a	n/a	n/a
	P2	1	+10	+40													
	R	3	+	+20										n/a	n/a	n/a	n/a
R1	3	-10	+20														
R2	2	-10	+														
S	<u>0</u>	<u>+1</u>	+80										n/a	n/a	n/a	n/a	

location III	T	2	-10	+30						n/a	n/a	n/a	n/a
	U	<u>3</u>	+	<u>-30</u>						n/a	n/a	n/a	n/a
	U1	<u>2</u>	<u>-2</u>	<u>-10</u>						n/a	n/a	n/a	n/a
	V	2	+05	-40						n/a	n/a	n/a	n/a
	W	<u>4</u>	-10	/						n/a	n/a	n/a	n/a
	X	<u>1</u>	<u>+25</u>	+40						n/a	n/a	n/a	n/a
	Y	2	+10	+						n/a	n/a	n/a	n/a
	Z	2	+10	+						n/a	n/a	n/a	n/a

Certain parameters of the size 3 chairs in the Table 39 are not given deliberately in order to comply with other size marks which by default are not given at all, such as: effective depth of seat (t4), width of backrest (b4), Inclination of seat (a), Angle between (c), height of armrest above seat (p) and width between armrests (r).

Table 40 Comparison of types of tables with EN 1729-1: 2015

table type	size to which it belongs according to EN 1729-1: 2015	dimensions (in mm), deviation from the normal dimension within the norm EN of default tolerance									
		height of table top	depth of table top	width of top, per person at front edge.	Width of top surface	Surface area per person (min, m ²)	Legroom	Height of footrest	inclination of the table top	vertical distance between the top of the	
		h1 (±20 mm)	t1	w1	b1		h2, h4, t2,t3	h9	y	z	
location I	1	<u>2</u>	<u>30</u>	+	+190	+	<u>-0,09</u>			-	+
	2	2	-2	+	+30	+	<u>-0,04</u>			-	+
	3	<u>2</u>	<u>-30</u>	+	+250	+	0,01			-	-1
	4	<u>2</u>	<u>-30</u>	+	+156,5	+	0,009			-	-1
	5	<u>2</u>	<u>-30</u>	+	+250	+	0,01			-	-1
	6	<u>2</u>	<u>-30</u>	+	<u>-100</u>	-	<u>-0,015</u>			-	-1
	7	<u>2</u>	-10	+	+78	+	<u>-0,0244</u>			-	+
	8	<u>2</u>	-10	+	+70	+	<u>-0,0539</u>			-	+
location II	9	3	-10	+	<u>-100</u>	-	0,8625			-	+
	10	3	-10	+	+156,5	+	0,0089			-	+
	11	1	20	+	+156,5	+	0,0089			-	+
	12	<u>2</u>	-10	+	<u>-100</u>	-	<u>-0,0229</u>			-	+
	13	<u>2</u>	<u>-30</u>	+	+250	+	0,01			-	+
	14	<u>2</u>	10	+	<u>-79</u>	-	<u>-0,0087</u>			-	+
	15	<u>2</u>	10	+	<u>-102,5</u>	-	<u>-0,0225</u>			-	+
	16	<u>3</u>	<u>-30</u>	+	+	+	<u>-0,88</u>			-	+
	17	<u>1</u>	<u>+30</u>	+	+	+	+			-	+
	18	<u>3</u>	-20	+	<u>-150/50</u>	+	<u>-/+</u>			-	+
location III	19	<u>2</u>	<u>30</u>	+	<u>-50</u>	-	<u>-0,067</u>			-	+
	20	<u>2</u>	-10	+	<u>-50</u>	-	+			-	+
	21	<u>2</u>	<u>30</u>	+	<u>-50</u>	-	+			-	+
	22	<u>2</u>	-10	+	<u>-50</u>	-	0/0,826			-	+

5.1.4. Comparison of furniture and anthropometric measurements of children

In order to compare children's popliteal height and the seat high of appropriate chair size, results of comparison are shown below.

In total, 36 types of chairs from all locations were listed ($P=0.43$) (Chart 11).

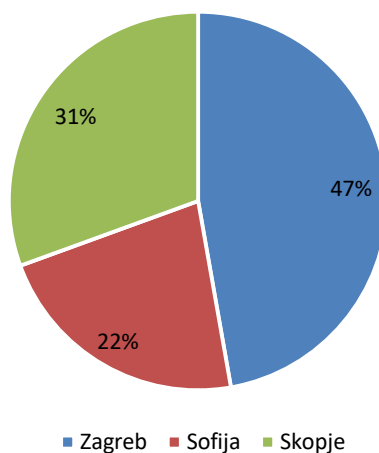


Chart 11 Proportions of examined chairs among investigated locations

When possible, the height of individual chairs was compared with the average popliteal height of individual age groups from individual cities. The permissible deviation is ± 10 mm. There was no significant difference found between examined locations regarding fitting the height of the chairs and the height of the children's popliteal height in any of the age groups (Table 41).

It is the smallest percentage (8.3 %) of the chairs that fits the youngest group of children, but there was/is very small number of children (in Sofia very few) in the youngest group in the kindergartens. Chairs, for the most part, fit children from 5 years old and up (Chart 12).

Table 41 Distribution of chairs that fit the lower leg of the children between the locations

	Number of examined chairs			P*	Total
	Sofia	Skopje	Zagreb		
Age from 2 till 3					
fit	no data	0	3/17	0.26	3/36
not fit		11/11	14/17		33/36
Age from 3 till 4					
fit	no data	3/11	4/17	>0.99	7/36
not fit		8/11	13/17		29/36
Age from 4 till 5					
fit	no data	4/11	2/17	0.17	6/36
not fit		7/11	15/17		30/36
Age from 5 till 6					
fit	4/8	4/11	4/17	0.44	12/36
not fit	4/8	7/11	13/17		24/36
Age from 6 till 7					
fit	5/8	3/11	4/17	0.18	12/36
not fit	3/8	8/11	13/17		24/36

Age from 7 till 8					
fit	1/8	3/11	8/17	0.25	12/36
not fit	7/8	8/11	9/17		24/36
Total	8	11	17		

*Fisher's Exact Test

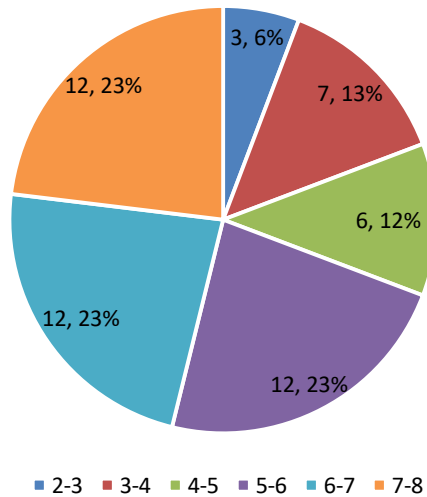


Chart 12 Number of examined chairs that fit the height of the children's lower legs regarding age groups

5.2. RESULTS OF SURVEY QUESTIONNAIRES

5.2.1. Results of kindergarten employees' survey

In the survey of kindergarten employees, a total of 593 responses was collected, equally distributed (P=0.21) between all location (Chart 13).

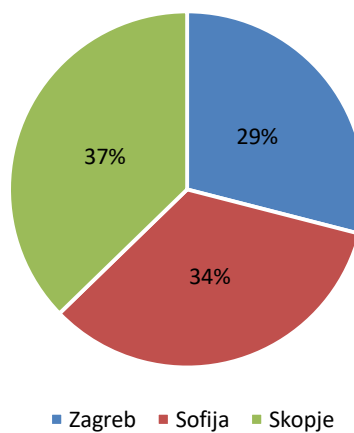


Chart 13 Proportions of examinees between investigated cities/polygons

A comparison between the kindergarten employees' responses in individual cities shows significant differences ($P < 0.001$) in almost all the questions that describe the current state of the kindergartens in terms of working conditions, space and furniture, their views on the current state and what the particular conditions in the kindergarten should be.

Among all of the examinees, most of them (70.3 %) were teachers/caregivers ($P < 0.001$). Most of them ($P < 0.001$) had less than five years of working experience (21.4 %) or more than 30 years (26.7 %), and their place of work was rarely ($P < 0.001$) outside of the settlements, only in 3.2 % of cases (Table 42).

Comparing the responses between the cities, the results show that in Skopje there is significantly more ($P < 0.001$) assistant teachers (39.3 %) compared to the other two cities/polygons, which do have a higher percentage of caregivers. Also, in Skopje, kindergartens have a significantly higher ($P = 0.01$) percentage of educators with up to 5 years of work experience (26.6 %) and in Skopje the kindergartens are in a significantly higher percentage (53.8 %) ($P < 0.001$) located in the inner city center and there is also a significant percentage of them outside of settlements (Table 42).

Table 42 General data on respondents

question/answers	number (percentage) of answers			P	N (%)
	<i>Sofia</i>	<i>Skopje</i>	<i>Zagreb</i>		<i>total</i>
1. Vocation of respondent					
teacher/ caregiver	145 (72.9)	123 (57.5)	125 (85.6)	<0.001†	393 (70.3)
educator	32 (16.1)	84 (39.3)	16 (10.9)		132 (23.6)
nurse	7 (3.5)	0	1 (0.7)		8 (1.4)
Pedagogue or psychologist	5 (2.5)	3 (1.5)	2 (1.4)		10 (1.8)
managing director	5 (2.5)	1 (0.5)	1 (0.7)		7 (1.3)
administration	5 (2.5)	3 (1.5)	1 (0.7)		9 (1.6)
2. Years of work experience:					
0-5 years	40 (20.3)	59 (26.6)	22 (15.0)	0.01*	121 (21.4)
6-10 years	26 (13.2)	35 (15.8)	29 (19.7)		90 (15.9)
11-15 years	20 (10.2)	27 (12.2)	12 (8.2)		59 (10.4)
16-20 years	17 (8.6)	25 (11.3)	12 (8.2)		54 (9.5)
21-30 years	28 (14.2)	37 (16.7)	26 (17.7)		91 (16.1)
More than 30 years	66 (33.5)	39 (17.6)	46 (31.3)		(26.7)
Part of the city where kindergarten is located:					
very centre of the city	88 (44.0)	119 (53.8)	37 (25.3)	<0.001*	244 (43.0)
broader centre of the city	112 (56.0)	86 (38.9)	107 (73.3)		305 (53.8)
outside the settlement	0	16 (7.3)	2 (1.4)		18 (3.2)

*Chi-square Test †Fisher's Exact Test

Most of the kindergartens ($P < 0.001$) have more than three hundred children (37.7 %), with mostly ($P < 0.001$) 4-10 separate educational groups per kindergarten (57.2 %). Significantly most often (Chi-Square Test, $P < 0.001$) the number of children per group is between 25 and 30 children (58.9 %) and two third of respondents (66.4 %) say that there are

more children in their group than there should be according to applicable standards ($P < 0.001$). Almost half of the respondents (48.7 %) combine the types of work in groups depending on the activity they perform (Chi-Square Test, $P < 0.001$) (Table 43).

Table 43 Properties of the kindergartens and their activity rooms/playrooms

question/answers	number (proportion) of answers			P	N (%) total
	Sofia	Skopje	Zagreb		
5. Kindergarten has a total of:					
less than 50 children	0	14 (6.5)	4 (2.8)	<0.001*	18 (3.2)
between 50 and 99 children	0	116 (53.5)	2 (1.4)		118 (21.0)
between 100 and 199 children	41 (20.5)	61 (28.1)	16 (11.0)		118 (21.0)
between 200 and 299 children	87 (43.5)	6 (2.8)	3 (2.1)		96 (17.1)
more than 300 children	72 (36.0)	20 (9.2)	120 (82.8)		212 (37.7)
6. How many educational groups (overall, regardless of the children's age) are there in your kindergarten					
1 to 3 groups	0	30 (13.6)	6 (4.1)	<0.001*	36 (6.4)
4 to 10 groups	147 (73.5)	158 (71.8)	18 (12.4)		323 (57.2)
11 to 15 groups	53 (26.5)	25 (11.4)	3 (2.1)		81 (14.3)
16 to 20 groups	0	6 (2.7)	37 (25.5)		43 (7.6)
more than 20 groups	0	1 (0.5)	81 (55.9)		82 (14.5)
8. How many children do you have in your group					
Less than 10	0	2 (0.9)	0	<0.001†	2 (0.4)
11-15	0	4 (1.8)	4 (2.8)		8 (1.4)
16-20	4 (2.0)	27 (12.3)	28 (19.3)		59 (10.5)
21-25	33 (16.8)	43 (19.6)	59 (40.7)		135 (24.1)
25-30	136 (69.4)	143 (65.3)	51 (35.2)		330 (58.9)
more	23 (11.7)	0	3 (2.1)		26 (4.6)
9. In the group, there are more children than stipulated by the standard					
Yes	122 (63.5)	176 (81.5)	66 (47.1)	<0.001*	364 (66.4)
No	70 (36.5)	40 (18.5)	74 (52.9)		184 (33.6)
10. Type of activities that is practice the most:					
activities in a larger group	26 (13.3)	163 (74.8)	6 (4.1)	<0.001*	195 (34.9)
activities in smaller groups	8 (4.1)	28 (12.8)	37 (21.0)	<0.001*	73 (12.4)
individual activities	1 (0.5)	56 (25.7)	11 (7.6)	<0.001*	68 (12.2)
all types of activities, depending on the type of task	160 (82.1)	11 (5.0)	101 (69.7)	<0.001*	272 (48.7)

*Chi-square Test †Fisher's Exact Test

There is a significant difference regarding the number of children per kindergarten ($P < 0.001$). Zagreb has the most children per kindergarten, more than 300 (82.8 %), while in Skopje kindergartens predominantly have fewer children (53.5 %). The results are similar when it comes to the number of groups per kindergarten ($P < 0.001$), except that in Sofia there is a smaller number of groups with a higher number of children per kindergarten, meaning that the groups were larger (Table 43).

When comparing the cities with regard to the question of whether the groups comprise a larger number of children than prescribed by applicable standards, a significant difference ($P < 0.001$) in percentage of yes/no responses shows that in Skopje there is a high percentage (81.5 %) of affirmative responses, while in Zagreb the percentage of affirmative responses is less than half (47.1 %). Regarding the type of activity practiced most often, in Skopje most

frequent are activities in large groups (74.8 %), while in Sofia (82.1 %) they mostly do all types of activities depending on the task (Table 43).

With regard to the size of the activity room, more than half of the respondents said their playroom is of an appropriate size ($P < 0.001$). However, there are significant differences found between polygons ($P < 0.001$), i.e. more than 2/3 of respondents in Sofia confirmed their playroom is of an appropriate size, while only 1/3 from Skopje say the same (Table 44).

In total, more than half of the examinees said that there was not too much furniture in the playroom ($P < 0.001$), with the respondents from Sofia being the most satisfied (66.2 %). That the activity room does not lack furniture or equipment for the storage of didactic toys, said more than a half of all respondents (51.7 %), but there is a significant difference between polygons ($P < 0.001$). In Sofia most respondents feel there is enough furniture (87.0 %) while in Skopje there is not enough furniture or equipment (65.3 %) for storing didactic objects, books and toys (Table 44).

Audio-visual equipment is placed in appropriately designed furniture in more than half of the kindergartens observed, but while in Sofia and Skopje this is the case in more than 2/3 of the kindergartens, in Zagreb this is the case in a significantly lower proportion of kindergartens ($P < 0.001$), only 27.8 % (Table 44).

Respondents in 58.9 % ($P < 0.001$) occasionally move the furniture in the playroom, more often in Zagreb and least often in Sofia. In only 23.4 % of the kindergarten's furniture is moved with difficulty, and in 59.5 % of cases furniture is rarely damaged (Table 44).

Table 44 Description of activity room in kindergartens (current state)

question/answers	number (proportion) of answers			P	N (%)
	<i>Sofia</i>	<i>Skopje</i>	<i>Zagreb</i>		<i>total</i>
11. The space (playroom) where you work with children is:					
is of appropriate size	143 (74.1)	80 (37.1)	76 (52.8)	<0.001*	299 (54.1)
is too small	48 (24.9)	40 (18.5)	61 (42.4)		149 (26.9)
is too big	2 (1.0)	96 (44.4)	7 (4.9)		105 (19.0)
13. There is too much furniture in the room(s) where you work with children:					
yes	9 (4.5)	35 (16.1)	28 (19.4)	<0.001*	72 (12.9)
no	131 (66.2)	124 (56.9)	39 (27.1)		294 (52.5)
the current situation is satisfactory	58 (29.3)	59 (27.1)	77 (53.5)		194 (34.6)
15. The playroom I work in lacks furniture or equipment for storing didactic equipment, books and toys:					
yes	20 (10.0)	143 (65.3)	72 (50.7)	<0.001*	235 (41.9)
no	174 (87.0)	49 (22.4)	67 (47.2)		290 (51.7)
I do not know	6 (3.0)	27 (12.3)	3 (2.1)		36 (6.4)
16. The audio-visual equipment is positioned on appropriately designed furniture:					
yes	134 (67.3)	141 (65.6)	40 (27.8)	<0.001*	315 (56.5)
no	52 (26.1)	41 (19.1)	101 (70.1)		194 (34.8)
I do not know	13 (6.5)	33 (15.3)	3 (2.1)		49 (8.8)

18. Do you often move furniture in rooms:					
yes	21 (10.7)	30 (13.8)	39 (27.1)	<0.001*	90 (16.1)
no, never	79 (40.1)	59 (27.1)	2 (1.4)		140 (25.0)
occasionally	97 (49.2)	129 (59.2)	103 (71.5)		329 (58.9)
19. If yes or occasionally, can you move the furniture around without any difficulty:					
yes	57 (35.8)	36 (16.5)	37 (25.7)	<0.001*	130 (25.0)
no	43 (27.0)	60 (27.5)	19 (13.2)		122 (23.4)
partially	59 (37.1)	122 (56.0)	88 (61.1)		269 (51.6)
20. I notice damage on the furniture:					
rarely	65 (33.7)	35 (16.5)	26 (17.9)	<0.001*	126 (22.9)
sometimes	107 (55.4)	134 (63.2)	86 (59.3)		327 (59.5)
often	21 (10.9)	43 (20.3)	33 (22.8)		97 (17.6)

*Chi-square Test †Fisher's Exact Test

A significant number of respondents ($P < 0.001$), 36.2 % of them, feels the playroom should be a multipurpose space in which they should be able to create appropriate units (creative centers/zones) together with the children. This opinion is mostly present in Skopje ($P < 0.001$). The combination of the carpet and parquet flooring is the most frequently (64.5 %) answer of floor among the respondents ($P < 0.001$) and there is no significant difference between polygons regarding this opinion ($P = 0.29$). Little more than half of the respondents would like to have furniture in colored wood (0.001), while only 13.1 % of respondents feel that the furniture should be installed or stationary ($P < 0.001$). Respondents are divided in answers when it comes to the question of whether the children should be able to move furniture as well (Table 45).

Table 45 Playroom, opinions of the teachers what is should be like

question/answers	number (proportion) of answers			P	N (%)
	<i>Sofia</i>	<i>Skopje</i>	<i>Zagreb</i>		total
12. The space (room) for working with children should be:					
open, without partitions and with a lot of furniture	54 (28.4)	48 (22.1)	7 (4.9)	<0.001*	109 (19.9)
divided into many small functional units with adequate furniture	24 (12.6)	44 (20.3)	49 (34.5)		117 (21.3)
one part is open and the other combines a number of thematic units (the so-called playing corners)	54 (28.4)	23 (10.6)	47 (33.1)		124 (22.6)
a polyvalent space where I am able to create appropriate units together with the children	58 (30.5)	102 (47.0)	39 (27.5)		199 (36.2)
14. The floors in the rooms where the children are most likely to stay should be covered with:					
parquet	38 (19.3)	49 (23.0)	26 (17.9)	0.29†	113 (20.4)
carpet or tapestry	8 (4.1)	7 (3.3)	4 (2.8)		19 (3.4)
combined carpet and parquet flooring	121 (61.4)	138 (64.8)	99 (68.3)		358 (64.5)
rubber or linoleum	20 (10.2)	13 (6.1)	12 (8.3)		45 (8.1)
ceramic tiles	1 (0.5)	4 (1.9)	1 (0.7)		6 (1.1)
it does not matter what kind of flooring is	9 (4.6)	2 (0.9)	3 (2.1)		14 (2.5)
17. The colour of the furniture should be:					
in one colour	7 (3.5)	4 (1.8)	11 (7.5)	<0.001*	22 (3.9)
in multiple colours	107 (54.0)	73 (33.2)	11 (7.5)		191 (33.8)
combining wood and colour	71 (35.9)	119 (54.1)	97 (66.0)		287 (50.8)
in wood texture	6 (3.0)	17 (7.7)	22 (15.0)		45 (8.0)
I do not know	7 (3.5)	7 (3.2)	6 (4.1)		20 (3.5)

21. The furniture in the room should be:					
easily to move around both to me and the kids	79 (42.0)	68 (31.3)	75 (52.1)	<0.001*	222 (40.4)
difficult to move, but I should be able to move it myself	64 (34.0)	125 (57.6)	66 (45.8)		255 (46.4)
stationary (mounted or fixed)	45 (23.9)	24 (11.1)	3 (2.1)		72 (13.1)

*Chi-square Test †Fisher's Exact Test

With regard to the types of chairs in the activity rooms, most kindergartens have one type of chair (54.0 %), followed by two types (33.2 %) ($P < 0.001$). In Skopje, one type of chair is significantly more common, while in Zagreb the proportion of kindergartens with one or two types of chairs is equal ($P = 0.005$). Most often, there is one chair height (55.9%) or two (36.9%) chair heights, whereby as many as 50.0% of kindergartens in Zagreb have two chair heights in the same playroom ($P < 0.001$). The chair heights are in a significant ($P < 0.001$) majority of kindergartens (86.1 %) appropriate to the height of the children (Table 46).

Table 46 Questions regarding children's chairs (current state)

question/answers	number (proportion) of answers			P	N (%)
	<i>Sofia</i>	<i>Skopje</i>	<i>Zagreb</i>		total
22. How many different types of chairs (by appearance) do you have in the room where you work with children:					
one	110 (55.3)	134 (60.9)	60 (41.7)	0.005*	304 (54.0)
two	59 (29.6)	69 (31.4)	59 (41.0)		187 (33.2)
three	16 (8.0)	10 (4.5)	17 (11.8)		43 (7.6)
more than three	14 (7.0)	7 (3.2)	8 (5.6)		29 (5.2)
23. How many different chair heights do you have in the room where you work with children:					
one	112 (58.0)	144 (65.2)	55 (38.7)	<0.001†	311 (55.9)
two	71 (36.8)	63 (28.5)	71 (50.0)		205 (36.9)
three	10 (5.2)	7 (3.2)	12 (8.5)		29 (5.2)
more than three	0	7 (3.2)	4 (2.8)		11 (2.0)
24. The heights of the chairs on which the children sit are in correlation with the height of the children:					
too high	3 (1.5)	11 (5.0)	8 (5.6)	<0.001*	22 (3.9)
too low	3 (1.5)	5 (2.3)	15 (10.5)		23 (4.1)
appropriate	189 (95.0)	177 (81.2)	116 (81.1)		482 (86.1)
I do not know	4 (2.0)	25 (11.5)	4 (2.8)		33 (5.9)

*Chi-square Test †Fisher's Exact Test

The responses to questions regarding the respondents' opinion on what the chairs in the kindergartens should be like show the following (Table 47):

- The chairs that the children sit on should have armrests (only for children in the ages 1-3 (37.3 %), and otherwise they should not (26.4 %) have armrests ($P < 0.001$)
- That the chairs should not have soft parts, deem a significant 61.8% of respondents ($P < 0.001$)
- The significantly most common ($P < 0.001$) opinion is that the chairs should be made of wood and wooden materials (59.9 %). There is a difference between polygons ($P < 0.001$), as in Sofia the respondents prefer if the chairs are made of plastic (50.3 %).

- In Skopje the respondents think that the chairs should have a serving tray (54.1 %), while in Zagreb they feel it should not (69.9 %) ($P < 0.001$), but when looking at the responses in total, most respondents (43.1 %) think the chairs should not have a feeding tray ($P < 0.001$).
- Children high chairs in nurseries should be low, thinks most of the respondents (49.6 %), and
- Most of the respondents agree that kids should be able to move chairs by themselves with no assistance (89.0 %)
- It is mandatory for kids in the nurseries to have chairs for independent sitting and eating (60.5 %).

Table 47 Questions regarding children's chairs, opinions of the teachers what is should be like

question/answers	number (proportion) of answers			P	N (%)
	Sofia	Skopje	Zagreb		
26. The chairs on which children sit should have armrests:					
yes, mandatory for all ages	5 (2.5)	66 (30.0)	8 (5.2)	<0.001*	79 (13.8)
for 1-3 year-old children only	33 (16.8)	68 (30.9)	112 (72.7)		213 (37.3)
for 3-7 year-old children only	5 (2.5)	67 (30.5)	0		72 (12.6)
no	130 (66.0)	2 (0.9)	19 (12.3)		151 (26.4)
I do not know	24 (12.2)	17 (7.7)	15 (9.7)		56 (9.8)
27. The chairs should have soft (upholstered, padded) parts in contact with the child's body:					
yes, as a rule	24 (12.2)	24 (10.9)	8 (5.5)	<0.001†	56 (9.9)
only the seat	25 (12.7)	30 (13.6)	20 (13.8)		75 (13.3)
only the backrest	2 (1.0)	1 (0.5)	5 (3.4)		8 (1.4)
no	111 (56.3)	153 (69.2)	84 (57.9)		348 (61.8)
I do not know	35 (17.8)	13 (5.9)	28 (19.3)		76 (13.5)
28. Children's chairs should be made mostly of which materials:					
wood and wood materials	61 (30.7)	159 (72.9)	117 (80.1)	<0.001†	337 (59.9)
plastic	100 (50.3)	12 (5.5)	0		112 (19.9)
metal	0	0	0		0
sponge	1 (0.5)	0	0		1 (0.2)
a combination of different materials	29 (14.6)	41 (18.8)	25 (17.1)		95 (16.9)
I do not know	8 (4.0)	6 (2.8)	4 (2.7)		18 (3.2)
29. Chairs in the nursery should have a serving plate (feeding table):					
yes	58 (29.0)	118 (54.1)	20 (13.7)	<0.001*	196 (34.8)
no	77 (38.5)	64 (29.4)	102 (69.9)		243 (43.1)
I do not know	65 (32.5)	36 (16.5)	24 (16.4)		125 (22.2)
30. Chairs for nursery children should be: (examples on the pictures)					
low	73 (36.5)	143 (65.9)	61 (43.3)	<0.001†	277 (49.6)
high	2 (1.0)	10 (4.6)	0		12 (2.2)
adjustable from a lower to a higher position	69 (34.5)	55 (25.3)	51 (36.2)		175 (31.4)
I do not know	56 (28.0)	9 (4.1)	29 (20.6)		94 (16.8)
31. Chairs and children's tables should be adjusted according to the children's height:					
yes, as a rule	28 (14.1)	134 (60.9)	36 (24.7)	<0.001*	198 (35.1)
no, the adjustment seems complicated to me	59 (29.8)	58 (26.4)	38 (26.0)		155 (27.5)
not necessarily, but it can be useful	82 (41.4)	28 (12.7)	68 (46.6)		178 (31.6)
I do not know	29 (14.6)	0	4 (2.7)		33 (5.9)

32. Children should be able to move the chairs themselves without your help:					
yes	182 (91.9)	184 (84.4)	134 (91.8)	<0.001*	500 (89.0)
no	2 (1.0)	26 (11.9)	11 (7.5)		39 (6.9)
I do not know	14 (7.1)	8 (3.7)	1 (0.7)		23 (4.1)
33. In the nursery group, children should have chairs for sitting and dining on their own:					
yes, as a rule	75 (38.3)	139 (63.5)	125 (86.2)	<0.001*	339 (60.5)
no, it's not necessary	55 (28.1)	45 (20.5)	15 (10.3)		115 (20.5)
I do not know	66 (33.7)	35 (16.0)	5 (3.4)		106 (18.9)

*Chi-square Test †Fisher's Exact Test

Most of the respondents would like to have tables with a round worktop (46.0 %), more often in Skopje (55.3 %) and Zagreb (53.1 %), followed by a rectangular worktop (33.2 %), which is more favored in Sofia (40.5 %). Four to six children should be seated at one table, according to a significant proportion of the respondents ($P < 0.001$), the majority in fact (65.5 %) (Table 48).

In 83.1% of kindergartens, the tables are of adequate size, the edges of the tables are appropriately rounded (79.7%), they are mostly easy to move (83.5 %) and the height of the tables where children sit is most often appropriate (88.0 %) relative to the height of the children (Table 48).

A significant ($P < 0.001$) majority of respondents, 79.6 % of them, feels that the children's chairs should not have wheels for easier mobility, and this is something that the respondents from all three Location agree on ($P = 0.28$).

Table 48 Description of the children's tables

question/answers	number (proportion) of answers			P	N (%)
	<i>Sofia</i>	<i>Skopje</i>	<i>Zagreb</i>		<i>total</i>
34. What type of table do you find most appropriate for working with children:					
a table with a round worktop	59 (30.3)	121 (55.3)	76 (53.1)	<0.001*	256 (46.0)
a table with a rectangular worktop	79 (40.5)	55 (25.1)	51 (35.7)		185 (33.2)
a table with a semi round worktop	36 (18.5)	10 (4.6)	5 (3.5)		51 (9.2)
a table with a trapezoid worktop	6 (3.1)	26 (11.9)	4 (2.8)		36 (6.5)
tables with irregular worktop shape	15 (7.7)	7 (3.2)	7 (4.9)		29 (5.2)
36. How many children should sit at one table:					
1-2	0	2 (0.9)	4 (2.8)	<0.001†	6 (1.1)
3-4	61 (31.0)	5 (2.3)	38 (26.6)		104 (18.6)
4-6	109 (55.3)	188 (85.5)	70 (49.0)		367 (65.5)
6-8	6 (3.0)	21 (9.5)	3 (2.1)		30 (5.4)
More than 8	0	3 (1.4)	1 (0.7)		4 (0.7)
depending on a current need, work and type of playing	21 (10.7)	1 (0.5)	27 (18.9)		49 (8.8)
37. The tables in the room where you work with your children are the right size:					
yes	185 (93.0)	158 (72.5)	124 (85.5)	<0.001*	467 (83.1)
no	10 (5.0)	35 (16.1)	17 (11.7)		62 (11.0)
I do not know	4 (2.0)	25 (11.5)	4 (2.8)		33 (5.9)
38. The edges of the worktops are:					
appropriately rounded	175 (87.9)	140 (66.4)	128 (87.7)	<0.001†	443 (79.7)
they have sharp edges and are dangerous for children	12 (6.0)	71 (33.6)	17 (11.6)		100 (18.0)
I do not know	12 (6.0)	0	1 (0.7)		13 (2.3)

39. The tables in the room where you work with your children:					
move slightly	180 (92.3)	193 (88.1)	93 (64.6)	<0.001†	466 (83.5)
difficult to move	15 (7.7)	18 (8.2)	51 (35.4)		84 (15.1)
stationary (fixed)	0	8 (3.7)	0		8 (1.4)
40. Tables for children should have wheels for easier mobility:					
yes	22 (11.2)	29 (13.3)	25 (17.2)	0.28*	76 (13.6)
no	164 (83.7)	174 (79.8)	107 (73.8)		445 (79.6)
I do not know	10 (5.1)	15 (6.9)	13 (9.0)		38 (6.8)
41. The heights of the chairs on which the children sit in correlation to the height of the children are:					
too low	7 (3.5)	13 (6.0)	16 (11.1)	0.01†	36 (6.4)
too high	2 (1.0)	12 (5.5)	4 (2.8)		18 (3.2)
appropriate	186 (93.5)	185 (85.3)	122 (84.7)		493 (88.0)
I do not know	4 (2.0)	7 (3.2)	2 (1.4)		13 (2.3)

*Chi-square Test †Fisher's Exact Test

With regard to the use of the furniture, there is a significant difference when it comes to the difficulty of manipulating the children's beds across the polygons ($P < 0.001$). In Skopje, the children's beds are difficult to manipulate (63.0 %), in Zagreb they are easy to manipulate (63.6 %), whereas in Sofia they are equally difficult (41.9 %) or easy to manipulate (42.9 %). Opinions regarding the sleeping areas are also partly different ($P < 0.001$), since in Sofia and Skopje almost everyone agrees that the sleeping area should be in a separate room, while in Zagreb as many as a third of respondents believe that the children should sleep in the activity room. Also significant is the difference in opinion on bunk beds ($P < 0.001$), with the majority in Skopje believing they are dangerous, and the respondents in Zagreb believing they are a good solution for separate sleeping areas (Table 49).

Table 49 Description of children's beds

question/answers	number (proportion) of answers			P	N (%) total
	<i>Sofia</i>	<i>Skopje</i>	<i>Zagreb</i>		
44. In terms of usage, children's beds are:					
difficult to manipulate (or handle)	83 (41.9)	138 (63.0)	9 (6.8)	<0.001*	230 (41.9)
they cannot simply be folded or stacked, something always gets stuck	4 (2.0)	58 (26.5)	21 (15.9)		83 (15.1)
they are easy to manipulate with	85 (42.9)	23 (10.5)	84 (63.6)		192 (35.0)
I don't know, I'm not paying attention	26 (13.1)	0	18 (13.6)		44 (8.0)
49. A place for children's rest and sleep should be set up:					
in a separate bedroom	182 (95.3)	197 (90.4)	76 (56.3)	<0.001*	455 (83.6)
in the same room where educational activities take place	6 (3.1)	21 (9.6)	45 (33.3)		72 (13.2)
does not matter where	3 (1.6)	0	14 (10.4)		17 (3.1)
50. Kindergartens should generally also have bunk beds:					
yes, they would save space	84 (42.6)	2 (0.9)	11 (8.1)	<0.001*	97 (17.5)
yes, but only if there is a dormitory in the kindergarten	22 (11.2)	0	107 (78.7)		129 (23.3)
no, that is dangerous for children	76 (38.6)	215 (97.7)	17 (12.5)		308 (55.7)
I do not know	15 (7.6)	3 (1.4)	1 (0.7)		19 (3.4)

*Chi-square Test †Fisher's Exact Test

In terms of storage furniture, there is a significant difference in the current state ($P < 0.001$) of the observed polygons/cities. The biggest difference regards the issue of cabinet

doors – in Sofia and Zagreb respondents prefer to have the possibility of closing the cabinets, while in Skopje they would rather have open cabinet types. There are no great differences on other issues, in most kindergartens cabinets are not too high for children (86.2 %), storage furniture is stable (71.6 %), and the furniture is rarely damaged (75.3 %) (Table 50).

Table 50 State of cabinet furniture

question/answers	number (proportion) of answers			P	N (%)
	<i>Sofia</i>	<i>Skopje</i>	<i>Zagreb</i>		<i>total</i>
52. The cabinets are too high in the room, the children cannot reach their things:					
yes	9 (4.6)	36 (16.4)	14 (9.7)	<0.001*	59 (10.6)
no	182 (92.9)	172 (78.5)	128 (88.9)		482 (86.2)
I do not know	5 (2.6)	11 (5.0)	2 (1.4)		18 (3.2)
56. Storage furniture in the room where I work with children is stable:					
yes	180 (91.8)	123 (56.2)	96 (67.6)	<0.001*	399 (71.6)
no	1 (0.5)	22 (10.0)	5 (3.5)		28 (5.0)
a certain part	15 (7.7)	74 (33.8)	41 (28.9)		130 (23.3)
57. What type of cabinet (wardrobe) do you prefer to use:					
open	4 (2.0)	146 (67.0)	31 (21.2)	<0.001*	181 (32.3)
closed with doors	168 (85.3)	13 (6.0)	110 (75.3)		291 (51.9)
combined, open-closed	25 (12.7)	59 (27.1)	5 (3.4)		89 (15.9)
58. The furniture in the room where you spend most of the time with children is damaged:					
yes, often	7 (3.6)	59 (26.9)	6 (4.2)	<0.001*	72 (13.0)
yes, but not so often	55 (28.4)	116 (53.0)	49 (34.5)		220 (39.6)
yes, but rarely	81 (41.8)	44 (20.1)	73 (51.4)		198 (35.7)
not at all	51 (26.3)	0	14 (9.9)		65 (11.7)

*Chi-square Test

Opinions on the characteristics of storage cabinets were also divided among the respondents in different cities. In Skopje, they believe that the height of the cabinets should be adjusted to the child so that the cabinets can also be used as a work space (70.2 %), while in Sofia and Zagreb opinions are divided ($P < 0.001$). When it comes to mobility, they most often think that cabinets should be castor-less and more difficult to move (47.3 %), while in the case of furniture for storing didactic items, toys and similar content, all cities point out that they lack more shelves and drawers and hooks and hangers (56.9 %).

A significant majority ($P < 0.001$) of the respondents believe that children's sanitary facilities should be adjacent to the activity room (85.1 %), while on the other hand opinions are divided on whether food should be served in the activity rooms and playrooms (Table 51).

The divided opinions on whether the teachers should receive training and consultations from experts on the application and use of the furniture in the kindergartens are surprising ($P < 0.001$). One third does not know, almost a half does not want to, and the difference between cities shows that only one third would participate in such programs in Sofia, with the percentage significantly lower in on the other two cities (Table 51).

Table 51 Opinion on cabinets furniture

question/answers	number (proportion) of answers			P	n (%)
	Sofia	Skopje	Zagreb		total
53. When it comes to the height, shelves and drawers in a cabinet should be:					
at the height of the child's reach so they can be used as workspace	75 (39.1)	153 (70.2)	78 (54.5)	<0.001†	306 (55.3)
high so that children cannot use them	7 (3.6)	24 (11.0)	0		31 (5.6)
depending on the contents, a) and b)	102 (53.1)	41 (18.8)	65 (45.5)		208 (37.6)
children should not be allowed to use cabinets	8 (4.2)	0	0		8 (1.4)
54. In terms of mobility, storage furniture should be:					
exclusively on wheels	25 (12.9)	43 (20.0)	84 (59.6)	<0.001*	152 (27.6)
without wheels and harder to move	89 (45.9)	127 (59.1)	44 (31.2)		260 (47.3)
built-in (stationary)	80 (41.2)	45 (20.9)	13 (9.2)		138 (25.1)
55. Furniture for the disposal of teaching aids, toys and similar content should have more:					
shelves	71 (35.9)	51 (23.8)	27 (18.6)	<0.001†	149 (26.8)
drawers	35 (17.7)	19 (8.9)	7 (4.8)		61 (11.0)
hooks or hangers	1 (0.5)	14 (6.5)	4 (2.8)		19 (3.4)
all of the above	81 (40.9)	130 (60.7)	106 (73.1)		317 (56.9)
I do not know	10 (5.1)	0	1 (0.7)		11 (2.0)
60. Children's restrooms (toilets and washbasins) should be located:					
close to the room where the children spend time	186 (95.4)	146 (67.3)	143 (97.9)	<0.001*	475 (85.1)
away from the room where the children spend time	9 (4.6)	71 (32.7)	3 (2.1)		83 (14.9)
61. Food should be served in rooms where children spend most of their time in a kindergarten:					
yes	83 (42.3)	64 (29.1)	76 (52.8)	<0.001*	223 (39.8)
no	104 (53.1)	109 (49.5)	57 (39.6)		270 (48.2)
maybe	9 (4.6)	47 (21.4)	11 (7.6)		67 (12.0)
62. You should obtain training with experts in the application and use of children's furniture in the kindergarten:					
yes, I have a lot of experience and ideas that could help	70 (35.4)	34 (15.5)	13 (9.0)	<0.001*	117 (20.8)
no, I don't want to	75 (37.9)	92 (41.8)	92 (63.4)		259 (46.0)
I do not know.	53 (26.8)	94 (42.7)	40 (27.6)		187 (33.2)

*Chi-square Test †Fisher's Exact Test

The following block of questions examining the teachers' general satisfaction with the activity space design and the working conditions offered responses graded on a *Likert scale* from 1 to 5 (from „do not agree at all“ to „completely agree“) and determined significant differences ($P < 0.001$) among the responses of the three polygons/cities (Table 52).

Table 52 Satisfaction with activity room design and working conditions

question/answers	median (IQR)			P*	P<0.05†
	Sofia	Skopje	Zagreb		
64. Are you satisfied with the arrangement of the room where you are currently working with children:	4 (3.0 - 5.0)	3 (3.0 - 4.0)	4 (3.0 - 4.0)	<0.001	1-2 1-3
65. Are you satisfied with the furniture in the room where you are currently working with children:	4 (3.0 - 5.0)	3 (3.0 - 4.0)	3 (3.0 - 4.0)	<0.001	1-2 1-3
66. Are you satisfied with the colours of the room where you are currently working with children:	5 (4.0 - 5.0)	3 (3.0 - 5.0)	3 (3.0 - 4.0)	<0.001	between all

67. Do you have enough space to move around in the room where you are currently working with children:	4 (3.0 - 5.0)	3 (3.0 - 4.0)	3 (3.0 - 4.0)	<0.001	between everyone (Skopje - more downgrades)
68. The furniture in the room where you are currently working with children is safe:	5 (4.0 - 5.0)	3 (3.0 - 5.0)	4 (4.0 - 5.0)	<0.001	between all
70. The chairs currently used in your kindergarten should have different structural design (appearance, shape, colours, materials...):	2 (1.0 - 3.0)	3 (1.0 - 3.0)	2 (2.0 - 3.0)	0.011	1-2 1-3
73. Setting up and making children's beds daily is a problem for me:	1 (1.0 - 3.0)	5 (3.0 - 5.0)	3 (1.0 - 3.0)	<0.001	between all
74. Children's beds currently used in your kindergarten should have different structural design (appearance, shape, colours, materials...):	2 (1.0 - 3.0)	3 (3.0 - 5.0)	2 (1.0 - 3.0)	<0.001	between everyone (Sofia - more downgrades)

*Kruskal-Wallis Test †Post-hoc Conover Test

Respondents from Sofia answered they are significantly more satisfied ($P < 0.05$) both in terms of the design of the room in which they currently work with children and in terms of the furniture in the room, compared to the respondents from Skopje and Zagreb.

Satisfaction with the colors used to decorate the room differed significantly between all three groups ($P < 0.05$). The most satisfied are the respondents from Sofia, followed by respondents from Skopje, with the least satisfied respondents being from Zagreb.

There was a significant difference between all three groups ($P < 0.05$) when it comes to the satisfaction with the size of the area of the rooms intended for free movement. Respondents from Sofia are most satisfied, followed by respondents from Zagreb, and least satisfied are those from Skopje.

The average safety rating of children's furniture also differs between all three groups ($P < 0.05$). The significantly highest grade was given by the Sofia respondents, followed by the Zagreb respondents, with the worst rating given by the Skopje respondents.

Sofia respondents were significantly more satisfied ($P < 0.05$) with the existing chairs compared to the respondents from Skopje, and compared to the respondents from Zagreb, who feel that the chairs should have a different design and construction (appearance, shape, color, materials...).

The daily set-up and preparation of the children's beds is the biggest issue to the respondents of Skopje, and the smallest issue to those from Sofia. There was a significant difference in the rating of this issue between all three groups ($P < 0.05$).

There was a significant difference in the assessment between all three groups ($P < 0.05$) of respondents when it comes to the question of whether the children's beds should be of a different design and construction (appearance, shape, color, materials ...). The

respondents from Skopje declared they wanted a change in the highest percentage, followed by respondents from Zagreb, while respondents from Sofia are relatively satisfied with the existing design of the beds (Table 52).

5.2.2. Results of furniture manufacturers' survey

In total of 12 respondents / companies, four from each of the three cities, were included in this part of the survey. The survey included questions on data regarding the business operations of the company (Table 53), data on tenders (Table 54), the current situation in the construction of kindergarten furniture (Table 55) and the (future) design of the kindergarten furniture (Table 56).

Most of the companies surveyed are registered for the manufacture or import and installation of furniture. They are significantly more often small businesses ($P=0.01$), the majority has the furniture tested by an authorized laboratory, and a significant majority ($P=0.01$) feels that the price of the product should not be the sole requirement of public tenders (Table 53).

Table 53 Distribution of responses in survey used among furniture manufacturers

Questions	Answers	Proportion of answers	P*
O1. What is your main registered business activity?	manufacture of furniture, products and semi-finished wood products	5/12	0.47
	sale of furniture, products and semi-finished wood products	2/12	
	production and sale of final timber products	0	
	import and sale of final products	4/12	
	import of furniture parts, assembly and sale of the final product	1/12	
O3. By company categorization, your company is...	small enterprise (from 1-49 employees)	11/12	0.01
	medium-sized enterprise (from 50-249 employees)	1/12	
	large enterprise (more than 250 employees)	0	
A1. How regularly do you apply to tenders for equipping kindergartens?	always, to every tender	3/12	0.89
	mostly yes	5/12	
	sometimes	2/12	
	no, we are not applying at all	2/12	
A11. Your company is applying for a tender because you believe that...	we have all the required elements in accordance with the tender documentation and we can compete with our price of the product	7/12	<0.99
	we have all the required elements according to the documentation and can compete with the quality of the product (at a slightly higher price)	6/12	<0.99
	we have already started cooperation with kindergartens, which we equip with our own product	4/12	0.68
	we collaborate with the architect/designer when equipping a kindergarten and produce furniture and equipment in accordance with his or her requirements	1/12	0.07
	we have a proper product line that contributes to the healthy development of children	1/12	0.07
	I do not know	0	0
A16. You are aware that public institutions in your country have a legal obligation to order furniture according to European standards .	yes	8/12	0.68
	no	4/12	

A17. The pre-school furniture line you produce / offer is tested by an approved testing laboratory ...	yes	9/12	0.40
	no	3/12	
A19. Do you think that price should be the only requirement in the procurement process?	yes	0	0.01
	no	11/12	
	I do not know	1/12	

*Fisher's Exact Test

The companies participate in all or almost all (8/12) tenders and most (8/12) are aware that public institutions in their country have a legal obligation to order furniture according to European standards. All companies have provided some of the reasons why they participate in tenders:

- partly because they have all the required elements according to the tender documentation and feel they can compete with the price of the product,
- partly because they have all the required elements according to the tender documentation and can compete with the quality of the product (at a slightly higher price),
- one third because they have already started cooperating with the kindergartens that they equip with their own product.

However, the reasons are significantly ($P=0.07$) not because they (already) cooperate with an architect/designer in the furnishing of kindergartens and manufacture furniture and equipment according to his requirements; nor because they (already) have a manufacturing program that assists in the healthy development of children (Table 53).

As regards the tender documentation, a significant majority believe that the tender documentation for kindergarten furnishing mainly ($P=0.003$) has sufficient information to make an appropriate bid and that the instructions and specifications obtained in the tender documentation are mainly ($P=0.008$) clear enough to manufacture the furniture. If the documentation is insufficient, the most detailed characteristics of the product sought should be given (Table 54).

Opinions are divided on the composition of the committee to select the most suitable supplier, but more often they choose a designer/architect or a specialist in the timber industry (7/12). Half of those surveyed (6/12) believe that the country lacks a detailed guide or rulebook for furnishing kindergartens and defining the characteristics of furniture. The same number of respondents (6/12) continued to communicate with the kindergarten manager after the announcement of the tender (Table 54).

Table 54 Distribution of responses in survey regarding tender procedures

Questions	Answers	Proportion of answers	P*
A 2. The tender documentation for equipping a kindergarten contains sufficient information in accordance to which you can prepare an appropriate offer...	yes, completely	0	0.003
	mostly yes	11	
	mostly not	1	
	no	0	
A 3. If the documentation is insufficient, what should be stated in the documentation?	the look and details of the products being procured	5/12	<0.99
	the exact dimensions of the products being procured	0	0.01
	more detailed characteristics of the products being procured	8/12	0.68
	a detailed description of the quality certificates	0	0.01
	more detailed terms in the tender documentation	1/12	0.07
A 4. Do you think that the instructions and specifications provided in the tender documentation are clear enough so that you are able to produce the furniture...	yes, completely	0	0.008
	mostly yes	10	
	mostly not	2	
	Not at all	0	
A 5. Are you satisfied with the process of public opening of the bidding documents submitted...	yes, completely	5	0.42
	mostly yes	4	
	mostly not	3	
	Not at all	0	
A 6. Specification documentation should be improved in the following way:	To contain the exact dimensions of each piece of furniture	4/12	0.68
	To contain a detailed list of specified characteristics of particular forms with drawings	7/12	<0.99
	To contain a detailed description of characteristics of the product being procured	6/12	<0.99
	To contain a detailed description of quality certificates	2/12	0.19
	To define specific terms in the tender documentation in a more detailed manner	0	0.01
A 7. The commission for the selection of the best bidder is made up of an appropriate number of professionals...	yes	5/11	0.77
	no	2/11	
	I do not know	4/11	
A 8. The commission for the selection of the best bidder should have an expert in the field of...	economy	1/12	0.07
	law	0	0.01
	design / architecture	7/12	<0.99
	wood technology	7/12	<0.99
	quality	1/12	0.07
	medicine	1/12	0.07
	something else	0	0.01
	I do not know	0	0.01
A 9. Your country lacks a detailed guide or rulebook for equipping kindergartens and defining the characteristics of such furniture...	yes	6	0.56
	no, but the existing one needs to be modified	3	
	no	2	
	I do not know	1	
A 12. After the publication of a tender, you continue your communication with:	the city office	1	0.44
	the kindergarten principal	6	
	Other...	5	

*Fisher's Exact Test

Most companies (7/12) declare that in total their offering includes more than 6 basic elements of a particular preschool furniture program (table, chair, desk, cabinet, wardrobe, AV cabinet, etc.). Cabinets are the products that the majority manufactures most often and in the

largest quantities, whereas only slightly more than half of them (7/12) use a standard. (Table 55).

Companies usually offer two or three sizes of furniture (10/12), and the sizes are most often indicated either by color and number or not at all (8/12). All of them declared that they are satisfied or mostly satisfied with the construction, manufacturing method and quality of the pre-school furniture programs they offer (Table 55).

Table 55 Distribution of responses in survey regarding the construction of the furniture

Questions	Answers	Proportion	P*
B 1. How many basic elements (in total) does each of the pre-school furniture lines (desk, chair, teacher desk, cabinet, wardrobe, AV cabinet, etc.) do you produce/offer?	one (e.g. only chairs for children)	0	0.28
	two (e.g. only chairs and desks for children)	1	
	three (e.g. chairs, desks and cabinets for children)	2	
	four (e.g. chairs and desks for children, cabinets and beds)	1	
	five	0	
	six	1	
	More than 6	7	
B 2. What items of furniture and equipment do you produce most?	chairs for children	5/12	<0.99
	desks for children	5/12	<0.99
	cabinets	9/12	0.40
	beds	4/12	0.68
	didactics	5/12	<0.99
	something else	1/12	0.07
B 3. When designing and constructing preschool furniture, which European/international standards do you use?	HRN EN 1729:2016	7/12	0.15
	HRN EN 1729:2006	0	
	HRN EN 1729:2003	0	
	HRN EN 1729:2001	0	
	HRN D.E4. 021:1989	2/12	
	JUS D.E4.201:1989	0	
	some other, please specify	0	
we do not use standards	2		
B 4. How many height classes (sizes) does your pre-school furniture line comprise, especially for tables and chairs you produce/offer?	1	0	0.33
	2	5	
	3	5	
	More than 3	2	
B 5. The height class of the furniture is marked with a specific mark ...	the colour of the stand	0	0.57
	the colour of the desk's work surface table and chair (backrest, seat)	1	
	the colour label on the declaration	0	
	a number (0-7) on the declaration or on the furniture	2	
	a number and colour on the declaration or on the furniture	4	
	in some other way	1	
we do not provide any labels	4		
B 13. Are you satisfied with the construction, production method and quality of the pre-school furniture line you produce / offer...	yes, completely	5	0.05
	mostly yes	7	
	mostly not	0	
	No	0	
B 14. Which of the following products do you produce sell in the largest quantities:	chairs	1/12	0.07
	tables	1/12	0.07
	chairs and tables	2/12	0.19
	cabinets (drawer system, shelving)	5/12	<0.99
	beds	0	0.01
	All of above	5/12	<0.99

*Fisher's Exact Test

A significant majority of companies ($P=0.008$) consider product design to be one of the more significant elements of the pre-school furniture manufacturing program they offer (Table 56).

The development and design of the products is most often the responsibility of an in-house wood technology engineer/constructor with an engineering bachelor's degree (5/12) or an in-house designer with a bachelor's degree in design (4/12). When it comes to the duration of the development of the products, opinions are divided (Table 56).

Respondents also disagree as to whether the current design meets contemporary market needs, and cannot point out what should primarily be changed in the furniture (Table 63).

More than half (7/12) of the companies are ready to invest some funds for the development and design of the new preschool furniture program, but only a third of the respondents would consult a design expert in the case of a new design or redesign of the production program (Table 56).

Most of the surveyed companies (7/12) consider the terms of the tender to be crucial for the design and construction solution of the preschool furniture program they offer, and the majority (8/12) consider the size of the chairs and tables (furniture as a whole) to fit the height of the children (Table 56).

Table 56 Distribution of responses in survey used among furniture manufacturers- design

Questions	Answers	Proportion of answers	P
C 2. You consider product design to be one of the significant elements of the pre-school furniture product range you produce/offer...	yes	10	0.008
	no	0	
	maybe	2	
	I do not know	0	
C 2. Who is involved in the development and design of the pre-school furniture line you produce/offer?	in-house MA in Design	4/12	0.68
	in-house MA in Architecture	3/12	0.40
	in-house MSc in Wood Technology/Construction	5/12	<0.99
	in-house MSc in Mechanical Engineering	2/12	0.19
	the company's development team	2/12	0.19
	the company's commercial department	2/12	0.19
	no one, we get the designs from abroad	1/12	0.07
	no one, we study existing solutions and align with the production process within our own company	0	0.01
	external collaborator, designer/architect	1/12	0.07
	someone else (please specify which profession)	1/12	0.07
I do not know	0	0.01	
C 3. The development of the product range of preschool furniture lasted... (in your opinion)	more than one year	3/12	0.91
	up to a year	2/12	
	up to 6 months	1/12	
	up to 4 months	0	
	up to a month	2/12	
	we have not been engaged in the development, we took over finalized products from another company	1/12	
	I do not know	3/12	

C 4. The current design of pre-school furniture available on the hr/mk/bg market meets the contemporary needs of children and teachers ...	yes	5/12	<0.99
	no	3/12	0.40
	partially	2/12	0.19
	I do not know	3/12	0.40
C 5. If not, what should be primarily changed on the furniture?	appearance (shape)	3/12	0.40
	construction	3/12	0.40
	material	3/12	0.40
	dimensions	0	0.01
	all	2/12	0.19
	the whole concept of working and sitting	2/12	0.19
	something else (please specify what)	0	0.01
I do not know	4/12	0.68	
C 7. You are ready to invest some money for the development and design of the new preschool furniture line ...	yes, of course	2/12	0.49
	yes, but only if we are guaranteed a return on investment through product competitiveness	7/12	
	yes, but only in case that	1/12	
	no, we are not interested	1/12	
	I do not know	1/12	
C 8. In the case of a new design or redesign of the product range, you would consult an expert in one of the fields ...	yes, in the field of design	4/11	0.68
	yes, in the field of construction	3/11	0.40
	yes, in the field of technology	2/11	0.19
	yes, in the field of ergonomics	2/11	0.19
	yes, in the field of medicine	0	0.01
	from another field	0	0.01
	we would not consult anyone	0	0.01
	I do not know	2/11	0.19
C 9. What is the key factor in terms of design and construction of the pre-school furniture you produce/offer?	possibilities of technological (production) process	5/12	<0.99
	tender conditions (demand as per a tender)	7/12	<0.99
	price (investment-return ratio)	3/12	0.40
	prescribed qualitative mathematical indicator	1/12	0.07
	something else	0	0.01
	I do not know	1/12	0.07
C 10. Do you consider the size of chairs and desks (overall furniture) well adapted to children's height	yes	8/12	0.68
	no	2/12	0.19
	partially	1/12	0.07
	I do not know	1/12	0.07

*Fisher's Exact Test

5.3. RESULTS OF THE MOSAIC METHOD WITH CHILDREN

A total of 36 children, with an average age of 5.8 ± 0.3 (mean \pm SD) years, from the city of Zagreb participated in the study. Children of both sexes participated equally (Chi-Square Test, $P=0.81$), 17 girls and 19 boys.

When asked where they would prefer to sit, they most often selected the armchair among the proposed chairs, but not with a statistical significance (Chi-Square Test, $P=0.46$) compared to the other chairs (Figure 22).



Figure 22 Proportions of selected chairs among children

Asked where they would prefer to stand or lie, the children most often selected with a statistical significance (Fisher's Exact Test, $P=0.001$) the last offered mat compared to the other mats (Figure 23).

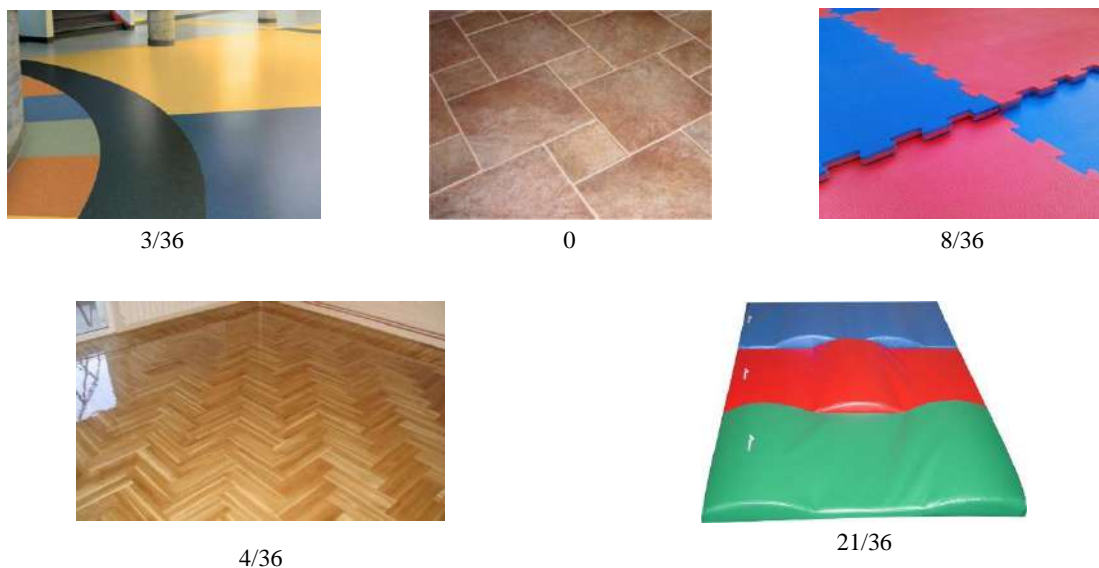


Figure 23 Proportions of selected floor mats among children

When asked where she would prefer to draw, the children most often chose the octagonal table among the tables offered. The selection is not statistically significantly the most common ($P=0.06$), but is on the border of significance (Figure 24).



Figure 24 Proportions of selected tables for drawing among children

When choosing among the offered colors of tables, the children most often selected the color blue (10/34), followed by red (7/34) and then pink (6/34), with no one selecting white (Fisher's Exact Test, $P=0.26$) (Chart 14).

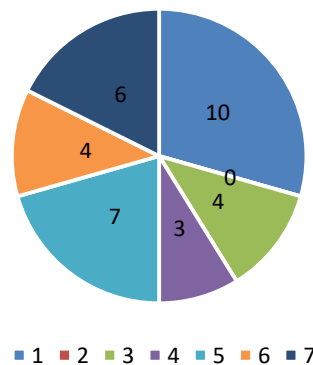


Chart 14 Number of selected table color

On the next set of proposed chairs, the children were more likely to choose yellow (9/32), followed by blue (8/32) then equally often green and pink (6/32) whereas red (1/32) and brown (2/32) were selected relatively rarely (Fisher's Exact Test, $P=0.35$) (Chart 15).

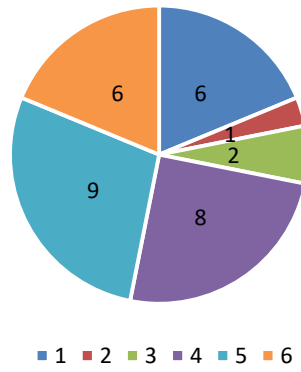


Chart 15 Number of selected chair color

When selecting among the multi-color types of chairs, the frequency of selecting a particular chair was as follows (Appendix V):



1



2



3



4



5



6



7

Figure 25 Appendix V, question no. 4c

1. The princess armchair (1) was chosen by a third of the children (11/34) all of whom were girls (Fisher's Exact Test, $P=0.01$),
2. The Spiderman pattern (2) set was selected by a little more than a third of the children (13/34), all of whom were boys (Fisher's Exact Test, $P=0.006$),
3. Only four of the 34 children selected the pink chair (3), all girls (Fisher's Exact Test, $P=0.43$),
4. The inflatable ball (4) was selected by a third of the children (11/34), significantly more often by the boys (Chi-Square Test, $P=0.04$), 10 of them,
5. The Mickey Mouse (5) armchair was selected by six children (6/34), equally divided between girls and boys (Fisher's Exact Test, $P>0.99$),
6. The Mickey Mouse pattern set (6) was selected by seven children (7/34), equally boys and girls (Fisher's Exact Test, $P>0.99$),
7. The animals-themed wooden chairs (7) were selected by a third of the children (11/34), slightly more frequently by girls (Chi-Square Test, $P=0.52$).

Asked to color in five squares with their favorite colors, the first choice were almost equally most frequently red and blue (8/36), followed by green (5/36), but no single color stands out significantly ($P=0.23$). The second square was most often colored in with green (9/36), followed by yellow (8/36) ($P=0.29$), while the third square was most often colored in using blue (7/36) ($P=0.54$). The distribution of colors for the third square is more even and all colors are represented, while in the first two squares some colors stand out a bit more while others are not used at all (Chart 16).

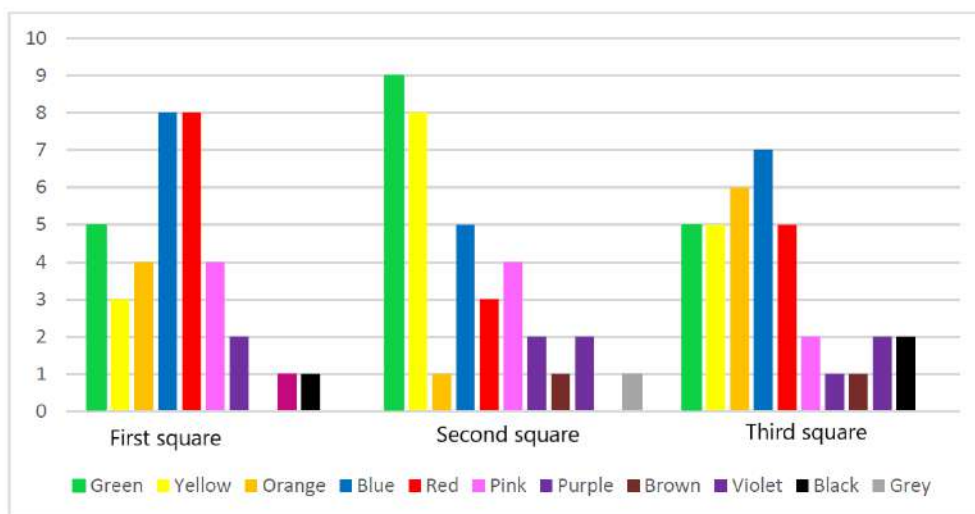


Chart 16 Frequency of colors used to color in squares

No statistically significant difference was found between boys and girls with regarding color selection for either the first (Fisher's Exact Test, $P=0.20$), the second (Fisher's Exact Test, $P=0.27$) nor the third (Fisher's Exact Test, $P=0.21$) square. However, there is a difference in terms of the "female" colors pink, purple and violet, which were used slightly more frequently by girls, while black and brown were selected exclusively by boys (Charts 19 and 20).

However, the most frequently selected colors, blue, red, green and yellow, were selected relatively equally by both genders (Chart 17 and 18).

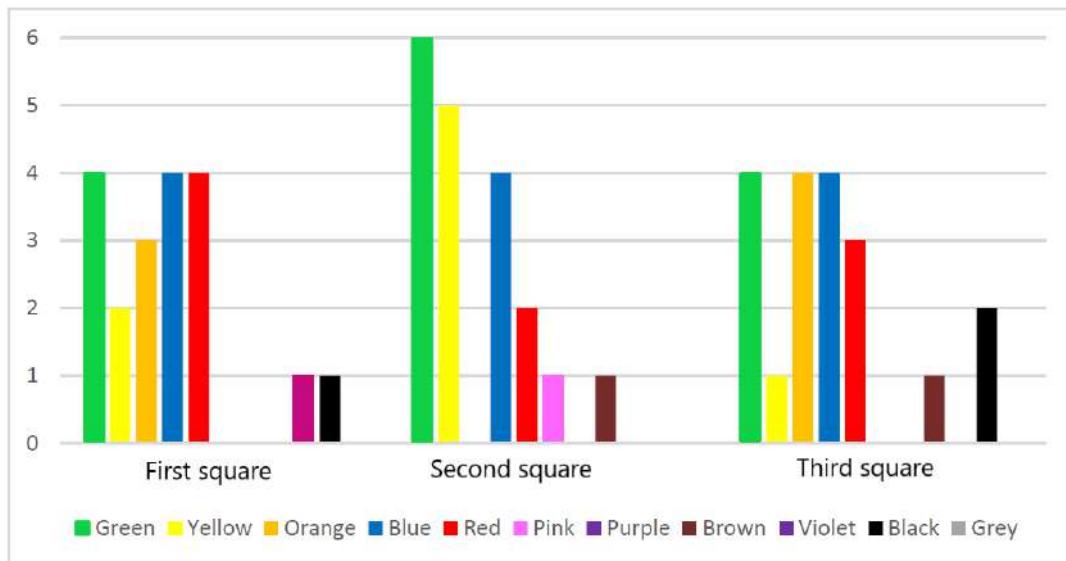


Chart 17 Frequency of colors used by boys

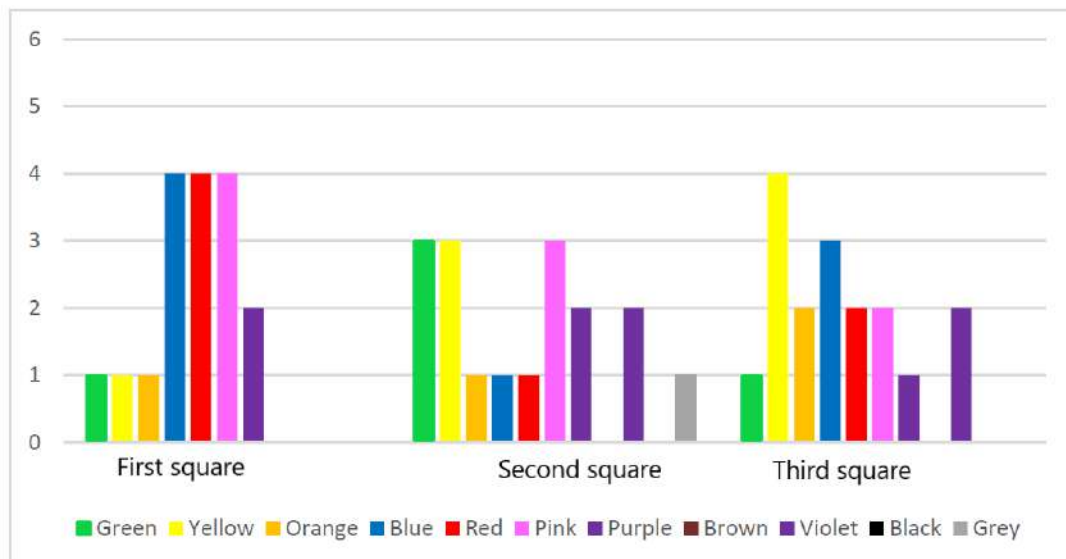


Chart 18 Frequency of colors used by girls

5.4. RESULTS OF THE METHOD OF OBSERVING AND PHOTOGRAPHING FURNITURE AND CHILDREN

The research using this method noted the characteristic positions of the preschool children's body, the distribution of the furniture in the playrooms and the overall atmosphere during the educational process in the kindergartens.

This method covers the respondents - children, where clearly are shown the characteristic movements and problematic position of the body in a sitting position during the educational process. While being photographed, children perform their daily activities and are unaware that someone is taking a photo. Improper body positioning and movement over a long period of time are dangerous to the growth and development of children. The photographs illustrate the inadequacy of the dimensions of the furniture with the growth of children (such as a high chair, inappropriate backrest

A photographic record is one of the most effective methods of providing facts that are or are not consistent with one's opinion. For example, the answer that children have the right dimensions of chairs is refuted in Figures 26 to 40. It is similar to seating positions, but also to furniture that is old, worn, or incorrectly marked according to the applicable and required standard.



Location III



Location III



Location I

Figure 26 Inadequate dimensions of chair with child growth. Too small or too large chair.

Photo: Iliev, 2018



III location



III location



I location

Figure 27 Significant discrepancies in chair dimensions with child growth.

Too small or too large chair. Photo: Iliev, 2018

Figure 28 Inadequate height of the chair,
III polygon.Too small chair, the child is cross-legged,
the shoulders are raised upwards.

Photo: Iliev, 2018

Figure 29 Inadequate height of the
chair, III polygon.Too large chair, cross-legged in an
unnatural position.

Photo: Iliev, 2018

Figure 30 Inadequate height of the
chair, II polygon.Too large chair, the lumbar back is
on the backrest.

Photo: Iliev, 2018



Figure 31 Sitting on the edge of the chair, II location.

Photo: Iliev, 2018



Figure 32 Inadequate furniture size, II location.

High table, improper body posture.

Photo: Iliev, 2018



Figure 33 Sitting on the edge of the chair while eating. II location.
Photo: Iliev, 2018



Figure 34 Inadequate chair size, II location.
Sitting with bent legs on the chair. Photo: Iliev, 2018



Figure 35 Inadequate body posture when playing.
Cross- legged under buttock, II location. Photo: Iliev, 2018



Figure 36 Inadequate chair size, II location.
The child does not touch the feet on the floor. Photo: Iliev, 2018



Figure 37 Inadequate height of the chair, I polygon.
Too large chair, the child does not touch the floor with his feet.
Photo: Iliev, 2018



Figure 38 Significant discrepancy of chair dimension with child growth, Polygon I.
Too large chair, the child does not touch the floor with the feet.
Photo: Iliev, 2018



Figure 39 Inadequate height of the chair, II polygon.
Too large chair, the child does not touch the floor with the feet.

Photo: Iliev, 2018



Figure 40 Inadequate body posture, II polygon,
Leaning over the chair with the head above.

Photo: Iliev, 2018

6. DISCUSSION

This chapter analyzes the results of the research, with the aim of offer concrete suggestions and solutions for more efficient and better design of preschool furniture based experiments performed in all the three polygons.

6.1. DISCUSSION ON CHAIR'S DESIGN

According to the presented results on all polygons, which differed from each other in terms of design, construction solution and dimensions. In terms of dimensions, most kindergarten have two sizes of chairs, small and large. Larger chairs are most often used in kindergarten groups of children from 3 to 7 years (according to the law in North Macedonia (***, 2016c), children from 2 to 3 years of age are included in kindergarten groups). The smaller type of chairs are used in groups of nursery units. In some kindergartens the smaller type of chairs is missing, so only one size is used in all the groups of children. According to the results obtained, it can be stated that this model of using two heights, or even only one (in a number of preschools), is not for the children's benefit at all.

In Skopje, six of eight kindergartens included in the survey have two sizes of chairs. The dimensions of the chairs from one kindergarten to another were of different proportions. The reason for this is due to the different manufacturers that equip them. Despite the existence of a European standard, which according to the age of the children indicates the use of four different dimensions of chairs, as well as the Rulebook for furnishing kindergartens in the Republic of Macedonia (***, 2016c) which determines use of two dimensions of chairs, there is evident deviation and diversity in terms of dimensions. In the other two kindergartens in Skopje, chairs of only one size were found, used by children from 1 to 7 years of age (Figure 41).



Figure 41. Examples of chairs that are inadequate for children's age in Skopje
Photo: Iliev, 2019

In Sofia, the situation is similar to Skopje. In half of the kindergartens the chairs are in two dimensions, one for the kindergarten groups and the other for the nursery groups. In the other half of the kindergartens, one sizes of chairs are used for all groups. Despite the existing European standard for equipping kindergartens, the difference in dimensions is quite evident from one kindergarten to another.

In Zagreb, in all kindergartens were found chairs in three or four different dimensions. It complies with the established European standard which determines four different dimensions of preschool chairs. However, in Zagreb all the four different dimensions are in the same playroom (as a rule, there is one age group of children in one playroom). In this case, the proper use of all four dimensions of the chairs would only be effective, if they were use by children with respective height.



a



b



Figure 42 Examples of chairs in Zagreb, where there are several different types of chairs in one room.

Photo: Iliev, 2018

When comparing the answers from the teachers' survey with the actual situation in the kindergartens there is a great divergence. According to the results of the chair measurements, anthropometric data and photographs, it can be stated that dimensions of the chairs are not suitable for preschool children. But according to the answers in the teachers' surveys completely different image can be seen. To the question "Whether *the height* of the chairs where the children are sitting in relation to the height of the children is appropriate or not" the total answer in all three locations is that the chairs are appropriate, being high on the scale with $N_t=86.1\%$. Individually, these numbers are: in Skopje $N_{sk}=95\%$, in Zagreb $N_{zg}=81.2\%$ and in Sofia $N_{so}=81.1\%$. According to the data and photos shown above, it is clear that there are various types of chairs and heights in preschools (mostly in Zagreb). In their answers the teachers point out that according to *the type* of chairs in the kindergartens, only $N_t=54\%$ have only one type of chairs, and according to the height of the chairs even $N_t=55.9\%$ respond that there is only one height. Each answer is given in the Table 46 in details.

From the answers of the teachers. it is stated that they do not make much difference in the furniture disproportions and that they either have little or no thought for any question related to it. With the furniture and spatial organization in the playrooms, although subconsciously this

gives them more problems (inadequate seating for children, inappropriate furniture for disposing of objects, difficulties in moving furniture through space, etc.)

The comparison of the dimensions of the chairs used in all three polygons with the European standard shows large deviations.

From the division into four height groups (size mark) from 0 to 3 for preschool age, only 3 chairs (J, O and U) fully fit the dimensions provided in the standard. If allowed tolerance of ± 10 mm is added for chair height and ± 20 mm for chair width, then 68 % of the chairs meet the European standard.

Table 57 Distribution of chairs that fits standard among polygons

Question/answers	Number of examined chairs			P*	Total
	<i>Sofia</i>	<i>Skopje</i>	<i>Zagreb</i>		
Fits the standards	4	8	12	0.59	24
Does not fit the standard	4	3	5		12
Total	8	11	17		36

*Fisher's Exact Test

Two-thirds (24 of 36) of tested chairs, fit to the standard ($P = 0.15$). In Skopje, the highest percentage of chairs meets the standard (72.7 %), while in Sofia this percentage is the lowest (50.0 %), but there is no statistical significance found ($P = 0.59$) possibly because of the small sample of chairs examined (Chart 19).

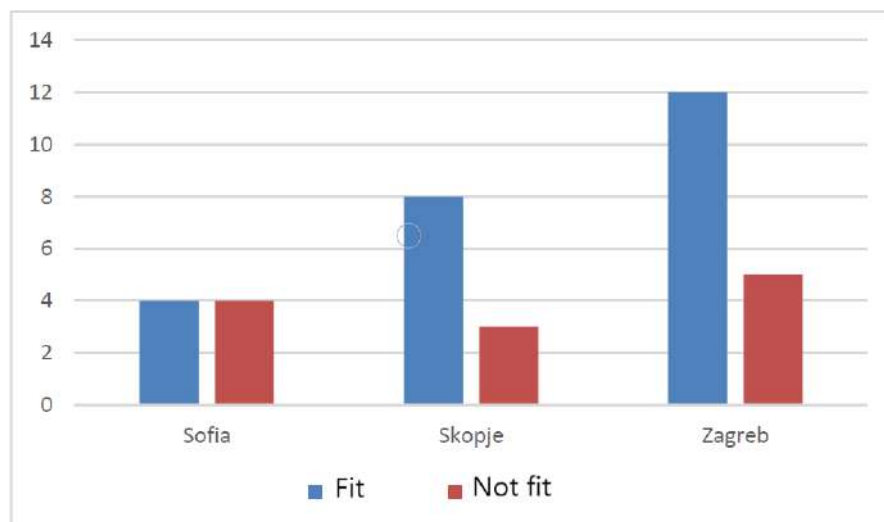


Chart 19 Proportions of examined chairs regarding fit or not fit to the standard

Many of the dimensions such as effective depth, backrest height, seat inclination, angle between the seat and backrest, height of armrest above seat, and width between armrests, are not shown in the European standard for size mark from 0 to 2. For size mark 3 the size of these dimensions is given in the standard, but the chairs found in polygons of size mark 3 are very under-represented compared to others.

From all this, it can be stated that according to the standards and rulebooks in all countries, the determined dimensions are not respected. The problem is not only caused by furniture manufacturers and demanders (kindergartens), but also by the shortcomings of the competent institutions that insufficiently monitor this very important problem.

Furniture in kindergartens is an integrated factor in the general conditions of preschool institutions. The shape and size of the furniture directly affects the psycho-physical development of children. The incompatibility of the furniture from anthropometric and ergonomic aspect affects the deformations in the child's later development (Bajbutović, 1983). Hence, inadequate dimensioning leads to an incorrect seating postures that causes so called *musculoskeletal discomfort and back pain - MSD/BP*) as well as fatigue during long sitting. Many authors deal with this topic, which is more relevant after the past few years (Anderson, G.B.J. et. al., 1974; Prebeg and Prebeg, 1985; Andersson, G.B.J., 1986; Popovič, 1989; Walker, 2000; Jones and Macfarlane, 2005; Domljan, 2011.). MSD/BP is an increasing problem both in every country and globally and affects 20 to 51 % of the children (Troussier et al., 1999).

Structurally, children are divided into two types of kindergarten groups, homogeneous and heterogeneous. Homogeneous groups include children of the same age group of 2-3, 3-4, 4-5, 5-6 years, i.e., until school age. Accordingly, it can be stated that children who actively use chairs can be divided into four age groups. The situation is different in the heterogeneous groups. There, children aged 3 to 7 years are staying in one playroom. Regardless of whether the children are in one or the other type of groups, the chairs should be dimensioned according to their growth, that is, the chairs should be divided into four size marks for each age group. To obtain the size of the chairs, comprehensive anthropometric research needs to be done to match them with the size of the children. On the other hand, the European standard EN 1729-1:2015 (***, 2015b) can be used in the section for chairs for preschool children, which is divided into four size marks from 0 to 3. In order to distinguish from one another, the colors used in the European standard can be used, being marked either in the lower part of the seat or on the legs.

Apart from the properly used chair measures, shape also plays an important role in the sitting process. According to Schröder (1997), when the body is actively seated, it changes many different positions, resting on the backrest, leaning towards the table, free movement of the legs in various positions such as stretching, crossing the legs or touching the feet on the floor. The problem with irregular sitting lies in inadequately designed furniture or in improper body posture during the sitting process. In the study of Schroder, two types of chairs are analysed, so called ordinary and ergonomic, for children aged 6 to 11 years. The author

concluded that much more body movement is possible with the ordinary, i.e. normal type of chairs than with the ergonomic ones. This is due to the fact that the chairs of the ergonomic type are higher, have a greater inclination of the seat and therefore it does not allow for greater movement, that is, it limits the movement of the legs in different positions. The body feels better when changing the position more frequently while sitting, than when it is all the time in the same position. Sitting in the same position for a long time, according to Troussier et al. (1999) causes an extremely undesirable physiological strain on the muscles, ligaments, and intervertebral. It is also generally accepted that sitting is healthier when sitting upright. Longer periods of sitting is more comfortable when the body can lean on a backrest. When leaning the body, and there is a backrest in the lumbar area of the back on the chair, sitting is more pleasant. The same thing also happens when the seat is tilted backwards to 5°.

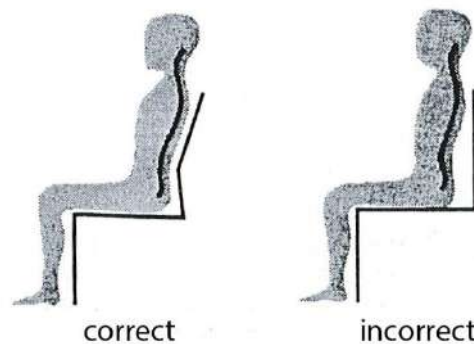


Figure 43 Posture of the back.
Source: Bujbutović, 1983

Mandal (cited in Knight, 1999) argues that sitting is based on four principles: 1. The need for lumbar support; 2. Inclined backrest; 3. Low chairs 4. Low tables. Autor reinforces this claim that the body leans on the desk when it works, reads or writes, which increases the angle between the lower back and thigh (in order to decrease the pressure of the lumbar vertebrae). This means that they lose contact with the backrest that ostensibly provides lumbar support. Therefore, a backward slope intended to help the body maintain contact with the backrest in fact increases the angle that the body must assume when leaning forward to work. Also, the low chairs increase the folding in the back.

The studies by Mandal (1982, 1986, 1994) each used a different constant seat angle and found subjects' preferred height of the front of the seat to center around their popliteal heights. Taller people tended to choose higher seat heights and shorter people tended to choose lower seat heights suggesting that people of different sizes prefer a similar range of postures if the

seat angle remains constant (Tuttle, 2000). From this it can be stated that the height of the chairs should be proportional to the popliteal height. When designing it is always necessary to fit the 95th percentile of the population for which the product is intended, hence based on the analysis of the data obtained from anthropometric research, comparing the popliteal height data can be seen to differ in centimeters of the 5th percentile and 95th. The percents are not greater than 1 cm or 2 cm. According to this, the seat height should be as much as the popliteal height of children entering the 5th percentile, which will not interfere with taller children at all.

According to Tuttle (2000), postures which can occur with 5th and 95th percentile stature students in the size chair recommended for their age group are shown in Figure 44. Taller students of those with higher popliteal heights may sit more extended knees as shown in Figure 44b or with increased hip flexion compared to smaller students when sitting in the same size chair. In that research, the author describes how increased hip flexion and/or knee extension increase torques acting on the pelvis to rotate the pelvis posteriorly, thus affecting lumbar posture. In the absence of any other forces under these conditions, the pelvis will rotate posteriorly and the trunk will either be more reclined or the lumbar spine more flexed. Alternatively, other forces – either in the form of forces, from the chair acting on the pelvis. The taller student can reduce these torques by sliding forward on the seat and reclining the trunk. Alternatively, the lower rear seat height selected by taller subjects in the current study may reduce the degree of knee extension. The choice of smaller (or more negative) seat angles by taller students may, therefore, be a means of reducing the torques on the pelvis and thereby reducing the effort necessary to maintain a sitting posture (Tuttle, 2000).

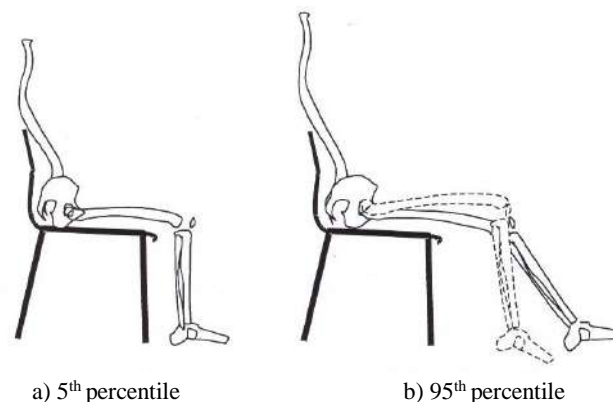


Figure 44 Extremes of size students using the largest size school chair.

Source: Tuttle, 2000.

When designing an ergonomic chair beside the seat height, the exact size of the seat width is also important, which is often overlooked. Inappropriate use of the seat width causes discomfort to the person sitting. For shorter persons, the front edge of the chair is often too far

forward, so that the blood vessels in the legs are compressed by the front edge, thus hindering the blood supply to the legs. The unpleasant and unhealthy consequences are cold feet and varicose veins (***, 2001). Seats that have relatively comparable large seat depth, such as those on airplanes, sit uncomfortably over a long period of time. A seat which is too deep inevitably deprives you of the full benefit of the backrest. Either you must lean back in a flexed position with the lumbar region essentially unsupported, or you must sit forward and lose contact with the backrest altogether. Neither is satisfactory (Goonetilleke and Feizhou, 2001).

Seat depth is governed, primarily, by anthropometry i.e. from upper leg length, buttock popliteal length, seated. Goonetilleke and Feizhou (2001) emphasised that “no study has systematically explored the subjective and objective effects of increasing and / or decreasing seat depth. This suggests that besides the anthropometry that should be taken as the main factor in the dimensioning of the chairs, an important condition is what type of chair should be produced (for eating, for work, for rest, etc.).

In the European standard (***, 2015a) in the size mark 0, 1 and 2, effective depth of seat is not given. For mark size 3, a size of 30 cm is given. Based on the anthropometric data obtained from this study as well as on the obtained knowledge explained above, recommendations and suggestions on how effective depth of seat should be are offered (Table 58).

Table 58 Suggestions for effective depth of seat

Parameters (The measures are expressed in cm)	City		
	Sofia	Skopje	Zagreb
	age between 2-3		
upper leg length, buttock-popliteal length, seated	/	23.5 (22.4 - 24.1)	23.9 (23.0 - 25.1)
effective depth of seat	/	21	21
	age between 3-4		
upper leg length, buttock-popliteal length, seated	25.2 (24.4 - 25.9)	25.5 (24.8 - 26.1)	25.9 (24.8 - 26.8)
effective depth of seat	24	24	24
	age between 4-5		
upper leg length, buttock-popliteal length, seated	26.1 (25.5 - 26.9)	27.0 (25.9 - 28.8)	27.8 (26.8 - 28.8)
effective depth of seat	24	24	24
	age between 5-6		
upper leg length, buttock-popliteal length, seated	29.3 (27.7 - 30.4)	29.4 (28.5 - 30.8)	29.3 (28.6 - 30.4)
effective depth of seat	27	27	27
	age between 6-7		
upper leg length, buttock-popliteal length, seated	31.7 (30.6 - 33.1)	/	31.1 (29.9 - 32.4)
effective depth of seat	29	/	29

According to all the above stated views it can be stated that the process of seating preschool children is a complex and delicate one. Chairs and tables should be designed to support the body, adapting especially to two very important functions that are related to the daily educational process of children, when the body is leaning on the backrest and the child follows the lesson and the teacher, and when the position of the children's body is in a folded position towards the worktop during processes and activities associated with the use of the worktop. Tables and chairs should be designed to provide a high-quality mode of use for both functions at the same time. Hence, the height of the chairs should be in proportion to the height of the children's lower legs, i.e. not to be smaller or bigger. The backrest should include a part that will support the lumbar part of the child's body in order to keep the back straighter. The angle of the backrest and seat should be between 100° and 105° , so that the body can lean forwards. Also, the seat inclination should be 5° to 7° .

According to this research, suggested preschool chair should be like on figure 45 and 46.



Figure 45 Posture of the body in a seated position.
Source: web 9



Figure 46 Chair for preschool age
Source: web 10

A kindergarten chair should be made of solid wood. Using the wood is the most expensive, but at the same time the most suitable for the children, especially in terms of tactile properties, warmth, softness and the impression of naturalness. Wood materials such as veneer plywood board (from which backrest and seat moldings are made) have similar properties. Given the price of solid wood, most wood materials (chipboard and plywood) are veneered or covered with foil or laminate. The use of wood and wood materials should be encouraged, as well as new materials that will be environmentally friendly, renewable, non-toxic and safe for the health of the users, and at the same time to have a decorative, visual function (Vlaović, et. al., 2008). Wood and wood materials have a longer shelf life, and after the end of their life they are completely biodegradable. The use of medium-density fiber boards should be avoided due to

the softness of the material, as on the surface they are more sensitive than other wooden materials, thus more quickly damaged when using plastics, safety, hygiene and all factors affecting children's health should be taken into account. Hedge (2015) has shown in the research that bacterias like *Escherihia coli* and *E. faecium*, do not stay such long on wood surface then on the plastic surface. Also, wood have better hygienic performance than plastic, possibly due to the hygroscopic properties of wood and the effects of wood extractives.

To question 28 (Table 47) of the teachers' Questionnaire: "Chairs should be made of the following materials", the total answer in all three location is that they should be made of: wood or wood materials Nt (total) =59.9%, plastic Nt=19.9% and a combination of different materials Nt=16.9%. By cities, the answers are as follows: in Skopje Nsk=72.9% consider wood and wood materials, the same is in Zagreb Nzg=80.1%, while in Sofia Nso=50.3% responded to plastic and Nso=30.7% considered wood and wood materials. The answers are perhaps logical because in Skopje and Zagreb most of the chairs are made of wood and wood materials, and in Sofia mostly plastic. According to this, the examiners respond according to what is available to them and known for their use, so they consider it best to use, without knowing whether one material is better than another.

The teachers' opinion about armrest is given on question number 26 (Table 47) "Should chairs on which children sit have an armrest" the total answer in all three cities is that there should be a armrest only for chairs used in nursery groups Nt=37.3%; those who disagree with the rule of armrest Nt=26.4%; mandatory for all ages Nt=13.8%; Nt=12.6% for children aged 3 - 7 only; and Nt=9.8% do not know. By cities, the answers are different: In Sofia, Nso=66% think there should be no armrest at all, in Zagreb Nzg=72.7% armrest to be present with chairs in the nursery groups, while in Skopje Nsk=30% think all chairs should have armrest; Nsk=30% only for children from nursery groups and Nsk=30% only for children from 3 to 7 years. Children from the nursery groups do not have good balance, so when they are seated on chairs with armrest, so that the body keeps its proper body position. Therefore, the armrest on the chairs used by these children should be a mandatory element. The teachers' answers do not give a clear indication of whether or not the chairs should have an armrest.

To the question No. 27 (Table 47) "Should the chairs have upholstered parts", most of the teachers, 61.8% in total and by cities (Nso=56.3%, Nsk=69.2% and Nzg=57.9%) consider that there should be no upholstered parts on the chairs. On the other hand, in the answer (number 1) to the Mosaic method of question "Where do you feel you most comfortable to sit", 13 children out of 36 responded that they feel more comfortable on an upholstered armchair and 8 children

out of 36 responded that they feel more comfortable on an upholstered chair. In the same survey (Dijanošić, 2019) conducted in Croatia and the Czech Republic most children responded that they want to sit on upholstered armchairs.

Interestingly, in both surveys, Dijanošić's and in this reasarches, separately conducted and at different times, the smallest percentage of children responded that they wanted to sit on the classic chairs currently used in the preschools. Another survey (Ratković, 2015) of preschool children with a similar question conducted in Croatia and Poland gives the same answer, with half of the children wanting to sit on a soft upholstered chair. From the answers given by the teachers and the children it can be concluded that the teachers do not prefer much the upholstered parts, while half of the children would like the upholstered parts. This data provides the basis for more extensive reflection and research as to whether children's chairs should have upholstered parts, or whether children's opinions and desires should be taken into account.

In the nursery groups, according to a conversation with certain teachers¹⁷ it had been suggested to use a mealtime chair with a tray. According to them, feeding on this chair is much more practical, easier and more visible. The answers from the teachers' surveys on question 29 (Table 47) "Whether the chairs in the nursery groups should have a mealtime tray" are divided. In Nso=38.5% and in Nzg=69.9% think that there should be no tray, while in Nsk=54.1% of the respondents think that there should be a tray. In response to all three cities, a total of Nt=22.2% do not know whether there should be a mealtime tray on the chairs.

The answer on the question whether the chairs should be high or low is as follows: Nt=2.4% are for high chairs, while Nt=49.7% think that low chairs are better for children because of their safety. On the other hand, Nt=31.4% of the agreements are that the chairs should be adjusted from low to high. The high chairs caused the children to fall off the chair on certain occasions resulting in serious consequences¹⁸ afterwards. Hence, it is concluded that the nursery group of children would prefer the use of a low height mealtime chair with tray, although in the opinion of the teachers it would be best to have ordinary chairs with no trays at all (Figures 47 and 48).

¹⁷ Conversation with teachers and educators from the kindergarten "Sonce" and "Buba Mara" in Skopje.

¹⁸ Conversation with teachers and educators from the kindergarten " Različak" in Zagreb



Figure 47 Preschool chair
Source: web 11



Figure 48 Preschool chair in playroom
Source: web 12

In terms of mobility, Nt=89% of the teachers believe that children should move their chairs on their own (question 32 of the teachers' surveys). The chairs should be made of materials that will not be difficult for children to manipulate, which will allow them to organize their space on their own when they have free activities. To the question number 33 "Should there be sitting and dining chairs in the nursery groups" the answer of a total of Nt=60.5% is that there must be. The question is asked in order to get an opinion on whether there should be chairs and tables in the playrooms. In the nursery groups where the children are on the floor most of the time, the question arises as to whether the sitting process is imposed by the paradigms that they must be sitted. This provokes further thinking and research as to whether sitting in a chair should exist at all in the nursery playrooms.

In the answers of the respondents furniture manufacturers / distributors, to the question "Do you think that the height of the chairs and tables is adjusted to the height of the children"- 8 out of 12 answered *Yes*. Considering the situation of the chairs in the kindergartens, it can be seen that the producers / distributors do not know the real situation at all, i.e. there is a non-compliance of the size of the furniture with the children's age. To the question of "How many height classes (sizes) does your pre-school furniture line comprise, especially for tables and chairs you produce/offer? – the answer is as follows: 5 companies produce two heights, 5 companies produce three heights and 2 companies more than three heights. Despite the claim of more than half of the companies for the production of three different heights, in reality they are not found in preschool institutions or they are not used for the appropriate age group for which they should be intended. This points out that in the complete system of manufacturing, demand and supply for this type of furniture lacks expertise and information. To the next question "Whether you mark the different heights with certain markings?,four companies

answered that they mark them with numbers and different colors of the label (although no markings were found on any of the chairs during the research) and four companies do not mark them at all (a real situation in the polygons where the research was done).

From the answers received by the teachers in the kindergartens at the end of the survey, which refer to the chairs (what they should look like), to the question "Do you think that the chairs that are currently being used should be changed in shape and structure? - the answers in Sofia and Zagreb are that they should *not be changed*, i.e. in Skopje that "*to some extent*" that they should be changed (Table 52). Despite the daily direct involvement of teachers and their experience and direct insight into the way children use chairs, they believe that some major changes should not be made in the shape of chairs, although research shows otherwise. The final solution to this problem is certainly not directly related to the teachers, but they can also contribute with their educational experience through concrete remarks, suggestions, and solutions for improving the working conditions of children. Hence, in the entire system of production, procurement, and demand of this type of furniture, consultation with competent staff is mandatory.

6.1.1. Comparison of popliteal height with height of seat

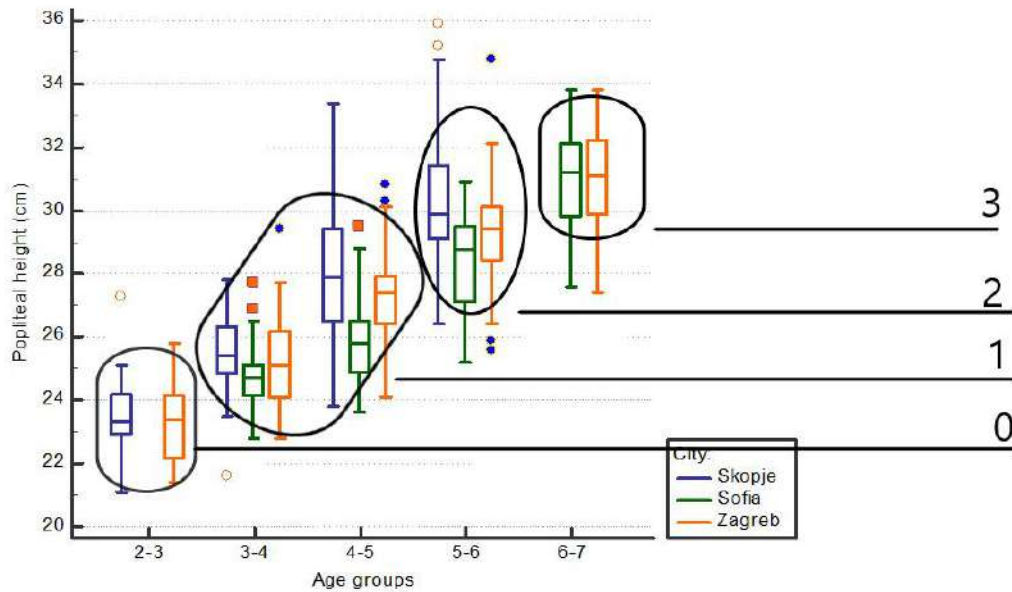
When comparing the popliteal height in seated position (H) obtained from anthropometric data with height of seat (h_8) according to European standard EN 1729-1:2015, it can be seen that for children of from 2 to 3 years old, height of chairs with mark size 1 would not fit their growth. The height of the chairs with mark size 0 would be more appropriate for them. From the results of this study we can suggest that the chairs that would be suitable for the growth of children at this age would be 23 cm of height. Children from 5 to 6 years old in location III in Sofia do not enter into the size mark 2, they would prefer a height of chairs between size mark 1 and 2, more precisely 29 cm of height. Other age groups of children may use the height of the chairs as determined by the standard (Table 59).

The seat width, when compared to the anthropometric variable hip breadth, maximum when seated, indicates that there are no deviations. Effective depth of seat is given as a sole size of chairs only with size mark 3 (300 mm) and when compared to anthropometric variable upper leg length, buttock-popliteal length, seat for children aged 6 to 7 years (31.7 cm Sofia and 31.3 cm Zagreb), can be taken as the correct dimension, but it would be correct to be several centimetres shorter than the standard.

Table 59 Comparison of popliteal height - seated with height of seat (h8) according to EN 1729-1:2015

*The measures are in cm

Anthropometrical variables	Mark size	Sofija	According EN 1729: 2015	Skopje	According EN 1729: 2015	Zagreb	According EN 1729: 2015
childrens' age 2 – 3 years							
<i>stature</i>	1	/	/	97.2 (94.6-99.5)	93-116	96.2 (91.9 - 98.9)	93-116
<i>popliteal range</i>	1	/	/	23.3 (22.9 - 24.2)	25-28	23.4 (22.1 - 24.2)	25-28
<i>hip breadth, maximum when seated</i>	1	/	/	21.1 (20.3 - 21.8)		20.9 (20.2 - 21.8)	
<i>h8</i>	1	/	/	23	26	23	26
<i>b3</i>	1	/	/	21	24	21	24
childrens' age 3 – 4 years							
<i>stature</i>	1	101.5 (99.6 - 103.7)	93-116	103.5 (100.4 - 106.5)	93-116	101.5 (100.4 - 104.2)	93-116
<i>Popliteal range</i>	1	24.7 (24.1 - 25.1)	25-28	25.4 (24.8 - 26.3)	25-28	25.1 (24.1 - 26.2)	25-28
<i>hip breadth, maximum when seated</i>	1	21.7 (21.1 - 22.7)		22.5 (21.6 - 23.5)		22.1 (21.3 - 23.1)	
<i>h8</i>	1	25	26	25	26	25	26
<i>b3</i>	1	22	24	22	24	22	24
childrens' age 4 – 5 years							
<i>stature</i>	1 2	105.2 (102.4 - 108.4)	93-116 108-121	108.4 (105.6 - 112.3)	93-116 108-121	109.1 (106.1 - 111.5)	93-116 108-121
<i>Popliteal range</i>	1	25.8 (24.9 - 26.6)	25-28	27.9 (26.5 - 29.4)	25-28	27.4 (26.3 - 28.0)	25-28
<i>hip breadth, maximum when seated</i>	1	22.1 (21.2 - 22.8)		23.3 (22.5 - 24.2)		22.3 (21.6 - 23.2)	
<i>h8</i>	1	26	26	28	26	27	26
<i>b3</i>	1	22	24	23	24	22	24
childrens' age 5 – 6 years							
<i>stature</i>	2	113.7 (111.4 - 117.2)	108-121	115.7 (113.3 - 119.8)	108-121	114.5 (110.1 - 117.6)	108-121
<i>Popliteal range</i>	2	28.8 (27.1 - 29.5)	28-31.5	29.9 (29.1 - 31.5)	28-31.5	29.4 (28.4 - 30.1)	28-31.5
<i>hip breadth, maximum when seated</i>	2	23.5 (22.6 - 24.2)		24.1 (22.8 - 25.5)		23.2 (22.3 - 23.9)	
<i>h8</i>	2	29	31	30	31	30	31
<i>b3</i>	2	24	28	24	28	24	28
childrens' age 6 – 7 years							
<i>stature</i>	3	122.4 (119.3 - 125.1)	119-142	/	/	122.4 (118.1 - 125.2)	119-142
<i>Popliteal range</i>	3	31.2 (29.8 - 32.2)	31,5-35,5	/	/	31.1 (29.9 - 32.2)	31,5-35,5
<i>hip breadth, maximum when seated</i>	3	24.5 (23.6 - 25.2)		/	/	24.3 (23.5 - 26.4)	
<i>h8</i>	3	31		/	/	31	
<i>b3</i>	3	25	32	/	/	24	32



* The measures are in cm

Chart 20 Division of popliteal height seated by age of children according to EN 1729-1: 2015

Certainly, these anthropometric data cannot be generalized because they are not made up of the whole population, but they are a good basis and would be useful for further research and discussion. The standard, certainly, cannot be changed solely because of some initial information received. The measurements made according to the European standard are used over a large geographical area and each has different natural and social factors that influence the growth of a child. It is therefore possible that some of the measures do not comply with the standard. Each country should, according to its specifics, conduct this type of research and compare it with European standards.

6.2. DISCUSSION ON TABLE'S DESIGN

The comparison of tables, carried out in the three polygons with EN 1729-1:2015 standard is far from satisfactory. Of all the tables in Location I, none meets the dimensional requirements that are determined by the standard. The width and length of the tables are within the permissible parameters, while the height and the space determined for one child per square meter (m^2) in more than half is out of the standard. In Location II, when adding ± 20 mm height on the table top only two tables of type 10 and 11 are within the determined standard, while for the others at least one of the dimensions does not fit the standard. In Location III also none of the tables is according to standard. Here, in addition to the height, the depth does not fit the standard.

To question number 37 (Table 48) of the teachers' Questionnaire "Do the tables you work with correspond to the size of the children"? - overall they agreed by saying Yes Nt=83% (Nso=93%, Nsk=72.5% and Nzg=85.5%). On the question "Whether the height of the chairs is too high"? altogether Nt=3.2% responded (Nso=1%, Nsk=5.5% and Nzg=2.8%), Nt=6.4% responded that they are too low (Nso=3.5%, Skopje 6%). and Nzg=11%) and that the tables correspond to the height of children with a total of Nt=88% (Nso=93.5%, Nsk=85.3% and Nzg=84.7%).

From the results obtained, it is evident that the tables are inadequate and age-adjusted and child-friendly. The responses of the teachers surveyed, on the other hand, are in stark contrast to this undeniable fact. Obviously, teachers cannot perceive at all differences in anthropometric data with the size and actual dimensions of the tables. For these reasons, a multidisciplinary team should be involved from the very beginning of the whole process of the creation of this type of product, aiming to design and construct a quality product that will fully fit, satisfy and fulfill all the aforementioned aspects.

In all kindergartens, two types of tables were found, higher and lower ones. The higher ones were used in the rooms where children aged 3 to 7 were staying, while the rest were in the rooms where the nursery units were, i.e., in the playrooms for children aged 2 to 3 years. The EN 1729-1:2015 determines four heights of tables marked from 0 to 3. When inspecting and analyzing the data of the tables, the same conclusion is reached as with the chairs, whereby a height difference should be made in the tables in four categories according to the age of the children: from 2 to 3, from 3 to 4, from 4 to 5 and from 5 to leaving for school. From the inspection it was found that in location I the lowest table is 50 cm, which falls into group 2, for children with height from 1080 - 1210 mm, in Location II the lowest table is 48 cm which enters size mark 1, while in Location III the lowest table is 52 cm in size mark 2. For children with lower stature these heights are inadequate. According to EN 1729-1:2015 each height has its own color, after which the tables should be marked. It can be marked on the lower legs or on the underside of the worktop.

According to some authors (Troussier et al., 1999; Bylon, 1962), the height of the worktop of the table can be obtained through the height of the elbow in a sitting position, with the addition of 3 to 5 cm. The exact height of the tables is an important factor in preventing the child's body or back. When writing or performing work activities the back tilts forward and the whole activity falls on it. If the tables are too low the bending is greater and leads to body discomfort. The anthropometric data for this population are very old or there are few. In the

region, in this area in the last five years there is only one master thesis¹⁹, which provides some basic data. A big problem is precisely the lack of such anthropometric data.

Another important factor affecting inadequately designed furniture is the misuse of materials. When manufacturing the worktops, materials that are resistant to cleaning agents should be used and have a high coefficient of surface mechanical damage. The type 4 (Table 16) of tables found in one of the polygons are made of MDF boards. In this type of tables, surface defects have been noted (Figure 49). The tables tops made of chipboard, without exception, should be edged with 3 mm ABS edging and rounded edges (many edges in the polygons/kindergartens were found with sharp edges). The tables also need to be made of materials so that they can be easily mobile, due to the everyday different activities that take place in the playrooms.



Figure 49 Damaged tables.
Foto: Iliev, 2018

In terms of mobility, preschool staff consider the tables to be easily mobile, with a total of $N_t=83.5\%$ (by polygons, Sofia $N_{so}=92.3\%$, $N_{sk}=88.1\%$ and $N_{zg}=64.6\%$). When answering this question in Zagreb $N_{zg}=35.4\%$ consider that the tables are difficult to move, while in the other two polygons the percentage is below 8%. Interestingly, there is a high percentage of respondents who do not want the tables to be on wheels, which makes mobility easier. Total number of those who responded with *No* is $N_t=79.6\%$ ($N_{so}=83.7\%$, $N_{sk}=79.8\%$ and $N_{zg}=73.8\%$) (Table 48).

Almost half of the teachers' survey responses to question 34: "What type - table form do you find most suitable for working with children"? $N_t=46\%$ answered "circular tables" (in polygons, in Sofia $N_{so}=30.3\%$, $N_{sk}=55.3\%$ and $N_{zg}=53.1\%$). A total of $N_t=33.2\%$ chose a table with rectangular worktop ($N_{so}=40\%$, $N_{sk}=25.1\%$ and $N_{zg}=35.7\%$) (Table 48). From the answers it can be stated that in terms of form, the tables should be rectangular or circular with

¹⁹Master's thesis (Iliev, 2011) as a result of the psycho-physical needs of the children.

the possibility of joining together and creating a larger workspace when performing a group task. Therefore, when equipping a preschool, it is advisable to communicate with the staff about which of these two forms to design, keeping in mind their opinion in order to facilitate their daily work and activity with children. In terms of utilization of the material from which the board is made, greater savings are made when the shapes are rectangular rather than circular.

To the Question 36: "How many children should sit at a table"? – most of the total number of respondents answered 4 to 6 children at a table $N_t=65\%$, (Sofia $N_{so}=55.3\%$, Nsk=85.5% and Nzg=49%); from 3 to 4 children $N_t=18.6\%$ and from 6 to 8 children $N_t=5.4\%$, (Table 48).

To question 2 of the Mosaic Method in which several types of tables are given, most children ($N_{zg}=19$) answered under c, followed by answers under e ($N_{zg}=6$) and under b ($N_{zg}=5$), figure 23. The same type of survey was conducted in Croatia and the Czech Republic in 2019 (Dijanošić, 2019) in which the answers are moving in the same direction, with most children wanting to sit and draw on tables b, c and e. The answer may be logical due to the fact that children are more likely to prefer working in groups.

6.3. DISCUSSION ON BED'S DESIGN

The comparison of beds with standards and rulebooks in terms of dimensions is within the prescribed limits. According to EN 747-1: 2012 + A1:2015 (***, 2015a) referring to bunk beds and high beds, Part 1: Safety, strength and durability requirements, in relation to the height of the upper surface of the lower bed with the lower surface of the upper bed, which is 75 cm, only one bed is not dimensioned according to the standard. Some of the beds do not have security fences C1 type. The clear distance between two successive treads shall be at least 20 cm in type C1 and C1 is not observed. Even if all the dimensions laid down in the standard for the bunk bed were to be met, the use of those beds from a security point of view is excluded. This is clearly stated in the standard: Bunk beds or the upper bed should not be used for children under the age of 6 (***, 2015a).

The answers of the teachers in all three cities are quite different. This is to be expected because of the different types of beds used. In Sofia, over 80% of the kindergartens surveyed use bunk beds. This type of bedding is often used because there is a separate sleeping room in each kindergarten, which requires additional, separate space, separate from the playroom. Hence, this type of bed saves space. However, the teachers in Sofia think that these beds are difficult to use $N_{so} = 41.9\%$, while $N_{so} = 42.9\%$ think that they have no problem using them

daily. The answers show that half are satisfied with this type of beds and half are not. Given the standard that clearly and unambiguously points out the non-use of bunk beds, a more detailed analysis of their alternative application and efficient replacement is necessary (Table 49).

In all the kindergartens in Skopje, fold-up beds are used throughout the day and are kept in lockers designed precisely for that purpose, so when the time comes to sleep, they are removed and placed in the playrooms. Due to the daily setting of beds Nsk = 63% of the respondents consider them to be difficult to manipulate, mostly for teacher over 50 years old; Nsk = 26.5% respond that in everyday use there is always a problem of various types (they do not fold-up completely, they are very difficult to fold-up, etc.); while Nsk = 10.5% have no difficulty manipulating them. All this indicates that it is necessary to change the design of the beds so as not to be a problem in daily use by the staff. (Table 49).

In Zagreb half of the kindergartens use a mattress placed directly on the floor, while in the other kindergartens a type B2 bed is used. Nzg=63.6% of the Zagreb's respondents/staff are satisfied with this type of beds and mattresses, Nzg=15.9% think that their everyday manipulation is a minor problem, while Nzg=13.6% do not know (Table 49).

Consequently, the daily setting and preparation of beds is a *major problem* for those employed in Skopje, in Sofia they are *not a problem* at all, while in Zagreb they are *somewhat* (dis)satisfied (Table 52).

As to whether there should be bunk beds, the answers are also different. In Sofia where this type of bed exists Nso=42.6% of it to consider it should remain, Nso=38.6% think it should not have it because it is dangerous and unsafe for children, Nso=11.2% say they should have this type of bed because it saves a lot of space. In Skopje even Nsk=97.9% think that using this type of bed is hazardous. In Zagreb Nzg=78.7% agree that this type of bed should be provided if they are in a separate room intended for sleeping only, and Nzg=12.5% do not agree at all that childcare facilities need bunk beds.

The results of the research show that the beds, especially in the location I and III, are inadequate and cause difficulties in the daily work of the staff. Despite the differences in the attitudes and opinions of the staff, their response to the question: "The beds you are currently using should have a different shape than the previous ones", that they may have a *slight change* (Table 52). However, whatever the answer of the staff to these types of questions, they should not be accepted completely, not only because of their incompetence, but also because of their subjectivity, driven by the fact that they are having difficulty in the daily use and use of the beds in general.

According to Stankovich (2009, cited in Iliev, 2011) the area where children sleep, are best kept in a separate room, or divided by a niche. In this case every child knows their own bed. The sleeping is completely separated from other activities, and children can rest or sleep even when there is no sleeping time, according to the programs of the institutions themselves. Static beds have better features because the mattresses do not have to be permanently folded and unfolded, thus retaining their shape and purpose for a longer time (Grbac, et. al., 2000).

6.4. DISCUSSION ON STORAGE FURNITURE

The storage furniture used only by children should be dimensioned according to their height, i.e. the highest shelf to correspond to the maximum reach of the children. Most of the storage furniture in Location I and Location III is not designed in this way. According to the answers obtained from the surveys with the teachers, $N_t=86.2\%$ of the respondents (Sofia $N_{SO}=62.9\%$, Skopje $N_{SK}=78.5\%$ and Zagreb $N_{ZG}=88.9\%$) stated that the height of the cabinets in the kindergartens fits the height of the children. It enables children to reach toys and didactic tools by themselves (Table 50). When asked how the cabinets should be: $N_t=55.3\%$ of the respondents ($N_{SO}=39.1\%$, $N_{SK}=70.2\%$, $N_{ZG}=54.5\%$) think that they should be at the height of the children; high cabinets so that the children can not reach the things, $N_t=5.6\%$ ($N_{SO}=3.6\%$, $N_{SK}=11\%$, $N_{ZG}=0\%$); Cabinets depending on the content- "high and low", $N_t=37.6\%$ in total ($N_{SO}=53.1\%$, $N_{SK}=18.8\%$, $N_{ZG}=45.5\%$).

It can be stated that the cabinets in Location III, part in Location I and a very small part in Location II, are at such a height that children could not reach the things set on them. Teachers, meanwhile, are of the opinion that the cabinets are at a height that suits children. According to the new pedagogical standards that indicates the full accessibility and freedom of children to play and work freely (Marković et al., 1997; Montessori, 1969), while some kindergartens do not meet this criterion.



a)



b)



c)

Figure 50 Cabinets

Cabinets too high (a, b) (Skopje and Sofia), cabinets that fit the height of the child (c) (Zagreb)

Photo: Iliev, 2017

At a conceptual layout of the interior in kindergarten spaces, the furniture should be on wheels²⁰, so that they can be moved with great ease, at the same time being able to organize a variety of interior concepts during the teaching and learning process. Despite this opinion $N_t=47.3\%$ or half of the respondents answered that the cabinets should be without wheels except in $N_{zg}=59.9\%$ consider they should be with wheels, while a total of $N_t=25.1\%$ prefer embedded cabinets (which do not move at all), (Table 51). Also, for this type of spatial organization where the premises are divided into smaller spatial units it is most useful to use furniture such as type b1 and b5, as well as their variations. In the physical division of space, the most useful pieces of furniture are of type b9, as they can be used on both sides.

In terms of height, for shelves or the cabinets furniture that divides the space, would be best to be equal to the child's standing posture height, so that didactic tools can be placed on surface on the cabinets furniture so that the children can play. Also, the cabinets furniture should provide accessibility from a visual point of view, that is, all objects should be visible. In other elements, the back or back parts can be used with the option of placing a didactic tool, on the front for disposal, and on the front as a toy (Figure 51).

The storage furniture should not be too high and too narrow, as it disrupts the statics and can tumble in the case of more heavy things on. Lower chest of drawers in the room gives greater visibility. Smaller furniture by size is more functional in the space than large and bulky furniture, due to their easier mobility.

²⁰ In a conversation with the teachers from the Kindergarten Različak, Zagreb in order to achieve greater mobility of this type of furniture, they should have dedicated castors.



Figure 51 Storage furniture.
Photo: Iliev, 2017

In all locations there are two types of wardrobe lockers used by children, closed type a7, b4, c2... and open type b3 and b8. According to the answers of the teacher, 51.9% are more in favor of the closed type of wardrobes, due to the greater organization and orderliness they offer (Table 50).

According to the teachers, the contents of the cabinets in the playrooms should have a total of 26.8% drawers, shelves 11%, a place to hang things 3.4%. Most of them agree that cabinets should have all these content elements together, a total of Nt=56.9% (Nso= 40.9%, Nsk=60.7%, Nzg=73.1%) (Table 51). On the question: "Is there a furniture lack in which the didactic tools and toys would be disposed", Nt=41.9% of all respondents consider that they are lacking (Nso=10%, Nsk=65.3%, Nzg=50.7%), while Nt=51.7% in total (Nso= 87%, Nsk=22.4%, Nzg= 47.2%) believe that they have enough cabinets to dispose objects in the playground (Table 44). Nt=56.5% in total consider that the audiovisual equipment they have is on an appropriate piece of furniture designed for this purpose only, while Nt=51.7% in total consider that they do not have a suitable piece of furniture for this type of equipment (Figure 52). Hence, when designing kindergarten furniture one should pay attention to this type of furniture as in practice it is often lacking.



Figure 52 Condition of the audio-visual equipment
Photo: Iliev, 2017

Each polygon has different design, number and composition of the storage furniture they need for everyday work. Therefore, in the process of designing and equipping a kindergarten, it is necessary to discuss and reflect on the opinion and experience of the staff, in order to organize a fully functional space, tailored to the needs of the children. This would enable children to have access to all the items that are located on the very element of the furniture so that without any problems and effort they could reach them independently because of their openness and visibility.

6.5. ATTITUDES OF EDUCATORS IN RELATION TO THE FURNITURE THEY USE IN KINDERGARTENS

The teachers in their answers give their opinions, remarks, suggestions and advice regarding the design of the furniture in the playrooms in which they work daily. Their thoughts and attitudes, based on years of experience in working with children are of particular importance to

be used in the design and production of appropriately designed furniture that will fit the psycho-physical activities of children.

- The surveyed teachers believe that the furniture in the playrooms is “*safe or somewhat safe*” (Table 52). In spite of this impression of the staff that the furniture is safe, any redesign or new design should particularly take into account its improvement in this segment (there are examples suggesting that the tables have sharp edges; lockers that are too high and narrow, so that the elements are disturbed by statics; the lower legs of the chair have wooden barriers that fall down during the course of their use and lead to an uneven position of the entire chair; ...).
- Concerning the question of how often furniture is damaged, the answer of the teachers in total is $N_t=13\%$ ($N_{so}=3.6\%$, $N_{sk}=26.9\%$, $N_{zg}=4.2\%$) is that they are often damaged; 39.6% of the respondents answered “yes, but not so often” ($N_{so}=87\%$, $N_{sk}=22.4\%$, $N_{zg}=47.2\%$); and that they are rarely damaged - a total of $N_t=35.7\%$ ($N_{so}=41.8\%$, $N_{sk}=20.1\%$, $N_{zg}=51.4\%$), (Table 50). In terms of the same question, how often do you notice some kind of damage to the furniture, $N_t=22.9\%$ of the respondents said “rarely” ($N_{so}=33.7\%$, $N_{sk}=16.5\%$, $N_{zg}=17.9\%$); “sometimes” $N_t=59.5\%$ ($N_{so}=55.4\%$, $N_{sk}=63.2\%$, $N_{zg}=59.3\%$); and “often” $N_t=17.6\%$ overall ($N_{so}=10.9\%$, $N_{sk}=20.3\%$, $N_{zg}=22.8\%$), (table 44). This leads to the conclusion that the furniture is damaging, hence, it should be paid considerable attention to the safety of the furniture when designing, which depends on the use of suitable materials, the choice of fittings and constructive solutions that will reduce the possibility of damage to the furniture in the first years of their use as a cause of injury and negative consequences to the children's health.
- Regarding the question of furniture mobility, $N_t=16.1\%$ of the teachers have given answer “it has been frequently moved” ($N_{so}=10.7\%$, $N_{sk}=13.8\%$, $N_{zg}=27.1\%$), $N_t=58.9\%$ of the teachers say “occasionally” ($N_{so}=49.2\%$, $N_{sk}=59.2\%$, $N_{zg}=71.5\%$) and “never” $N_t=25\%$ overall ($N_{so}=40.1\%$, $N_{sk}=27.1\%$, $N_{zg}=1.4\%$). The furniture that they move from one place to another in the playroom for the purposes of the educational process, is moved “with no difficulty” answered a total of $N_t=25\%$ ($N_{so}=35.8\%$, $N_{sk}=16.5\%$, $N_{zg}=25.7\%$); “there are some types of transportation difficulty” for overall of 51.6% of the teachers ($N_{so}=37.1\%$, $N_{sk}=56\%$, $N_{zg}=61.1\%$); and “there are no difficulties in moving” for $N_t=23.4\%$ of the preschool staff, (table 44). $N_t=40.4\%$ of the teachers prefer easily mobile furniture in the playrooms, or not so easy to move, but the

teacher can move $N_t=46.4\%$, (Table 45). It can be stated that furniture mobility is a problem in the daily work activities of the staff and children. Therefore, more attention should be paid when designing preschool furniture in order to allow for easier mobility of it in the playroom. Burić (2006) argues that the greatest shortcoming of furniture is the inability to modify its function, mobility and combination in various forms. In order to be able to make children's environments work for them, we need to create a generic environment that can take different shapes and adaptations for different purposes, and this can be achieved if the furniture in the premises can be moved from one place to another without difficulty.

6.6. EDUCATORS' VIEWS ON THE APPLIED COLORS

From the research carried out in all three Locations through the method of surveying teachers and children about colors and their application, the following can be seen:

- Teachers believe that furniture by color should be in combination with wood and paint $N_t=50.8\%$ in total ($N_{so}=35.9\%$, $N_{sk}=54.1\%$ and $N_{zg}=66\%$); colorful, i.e. $N_t=33.8\%$ of the total ($N_{so}=54\%$, $N_{sk}=33.2\%$ and $N_{zg}=7.5\%$); in texture of wood a total of $N_t=8\%$ ($N_{so}=3\%$, $N_{sk}=7.7\%$ and $N_{zg}=15\%$); in one color total $N_t=3.9\%$ ($N_{so}=3.5\%$, $N_{sk}=1.8\%$ and $N_{zg}=7.5\%$); and don't know $N_t=3.5\%$ of the total, (Table 45). According to the results, as well as from the data obtained from the above mentioned experts' literature, the furniture should be in neutral tones and not in too vivid, intense colors in the interior. The use of furniture that retained the natural wooden look is most appropriate, with a slight discreet use of color.
- The teachers in Sofia are *satisfied* with the colors used to decorate the premises where they work with children, while in Skopje and Zagreb they are *somewhat satisfied* with the colors used (Table 52). Having in mind the answers of the teachers it can be stated that they are not completely satisfied with the use of colors in the kindergartens. Therefore, more attention should be paid to their use in future. This would be achieved by forming a multidisciplinary team of professionals who would establish rules and norms for the proper use of colors. The idea is not to limit the creativity of furniture and interior designers, but to assist in the process of designing it, what effect the color has in the space, the intensity it should have and the quantity that should be used.

- From the offered seven chairs of the same type but in different colors (pink, blue white, purple, light blue, red and gray), most of the children responded that they wanted blue (10/34), then yellow (7/34) followed by pink, but no one chose white (Appendix V).
- To the the next question where as well there are offered chairs of the same type in 6 different colors (green, red, brown, blue, yellow and light pink), most of the children chose yellow chairs (9/32), blue (8/32), evenly green and red (6/32), brown (2/32) (Appendix V).
- To the following given task to color a square with their favorite color (three squares were given), the first square was mostly colored red and blue (8/36), then green (5/36); the second square is most often colored green (9/36) and yellow (8/36), while the third one is mostly colored blue (7/36). No statistically significant difference was found between boys and girls with regard to color selection for either the, nor for the second nor for the third square. However, there is a difference in terms of "female" colors, pink, purple and violet being slightly more chosen by girls, while black and brown were chosen exclusively by boys (Charts 17 and 18). When comparing the results obtained from the children of this study, the analysis of the data obtained from the specific literature, we come across identical results. Children recognize and select primary and secondary colors (yellow, red, green, blue, orange, pink, violet ...). They recognize white, black, brown and gray, but they are not so appealing to them (a few children have chosen these as the desired color).

There are a lot of literature sources for the psychology of color, that is, its influence over children, and the way it is used in the playrooms (Vodenova, 2017; ***, 2011; Kirova, 2006; Starmer, 2005; Valkov, 2001; Pisareva, 1999). The intention in this thesis is not to analyze the colors, but to provide basic information on how to use them in the area where children work. In the countries where such a research has been carried out, there are no specific proposals and suggestions on which colors should be used and how to be used in preschool facilities, hence the need for certain standards based on scientific research, as a guide to designing the furniture and arranging the interior of preschool facilities as a necessity. This would avoid the possibility that the interiors would be edited in color only according to the wishes of the staff in the kindergartens. Because of this, there are examples where children perceive the place as a dark area and do not like to visit preschool facilities. One of the many factors influencing this, though at first glance, it is the negligible choice of colors in the playrooms. From the foregoing, it is

concluded that color influences the general ambient and atmosphere in the playroom, with an indirect influence on the psychophysical development of children.

6.7. SPATIAL ORGANISATION IN THE PREMISES OF THE KINDERGARTENS

Children spend most of their time playing. Through play they achieve social interaction, acquire new experiences, and the older preschool children begin to control their emotions in group work. The environment and social interaction greatly affect the development of character, and this is achieved through a common children's play. Both Nikoloska (2002) and Dobrevska (2012), explains the concept of the play, in terms of the treatment of various theorists. The play is considered as an asset where the child releases excess energy that cannot be spent otherwise. Also, the play represents a complement to the energy of the child, which it has spent learning unfamiliar and new tasks. the play as a tool for practicing skills that are essential for survival and it can be concluded that the play is primarily means for the overall physical and mental development of the child (Nikoloska, 2002; Dobrevska, 2012; Sandahl, 2019).

According to Nikoloska (2002) dealing with the developmental psychology of children, the play is divided into several forms. The first and simplest is an observational play that appears in the first years of the birth of the child. The child is not able to establish social interaction with another child hence it will only observe other children or adults in their activities. The infant mostly plays alone or with a toy, which at that moment caught its attention.

As infants from the ninth to the twelfth month, which includes the first nursery group, spend most of the time sleeping or lying, playrooms should be organized so that there are children's beds that will be collapsible. Infants at this age begin to perceive the world and mature motor skills better than before, and they begin to move independently in the space byway of crawling. Therefore, playrooms should provide sufficient space in which they could move. Nursery playrooms that cater for these groups of children do not require large spaces, not less than 40 m². As infants do not establish social interaction, unless an adult provides it, the need for a separate space for playing, divided by a niche, is optional. The furniture necessary in the playrooms includes boxes or shelves for placing the toys (Raycheva, 1998; Stevanovič, 2001; Herrington, 2003; Colbert, 2006; Fiechtner and Albrecht, 2015; Remenschneider, 2017).

The child makes its first attempts to establish social interaction through *solitary games*. The child, from an observer, begins to establish some connection with children who are already playing. Maybe there exists some social interaction, but it is still inconsiderable (Nikolovska,

2002). This type of play is also most present with infants or children aged from birth to three years.

Infants aged 18 months to 2 years, which includes the second nursery group, make efforts to stand straight, grasping for an object in front of them or are in the phase of beginning steps, but still not quite stable. For this reason, in addition to beds, the playrooms should contain shelves or storage boxes for the toys that will have no sharp edges or made from a material that cannot cause injuries in case the infant falls trying to establish a balance when attempting to walk. As this age shows greater social interaction, i.e., in a given short period only two children can play, playrooms should be somewhat larger than the previous ones, because the process of playing requires more space (Stevanović, 2001; Nikoloska, 2002; Stanković, 2009).

Infants from 2-3 years of age start to stand on their own, playing games that take advantage of a seated position such as, for example, dice setting, drawing and the like, so that in the playroom, the tables and the chairs are projected at their height. As the children begin to play with each other, and with the presence of more furniture, the room needs a larger space, not less than 50 m² (Nikoloska, 2002).

For children in the early childhood period, at the age of 3-6 years, parallel, associative, and cooperative games are characteristic. Parallel game is a form of a game where children sit side by side with similar content, with no social interaction. Associative game allows social interaction of a group of children, but there is no concrete division of roles and achievement of a final goal (Nikoloska, 2002; Stanković, 2009). Cooperative games represent the highest level of social interaction in the preschool period when children are grouped together to carry out specific activities in order to achieve a specific goal (Nikoloska, 2002). The children have divided their responsibilities.

The children in the small group, aged from 3-4 years, are organized in a group of two to three children, but their interaction lasts from 20 to 30 minutes. Very often they switch games and emotions (Nikoloska, 2002). For this reason, the areas of interest should be divided into small sections (zones), divided with physical partitions or partition walls made of the furniture itself or the toys. It is better to have more such small play areas/zones, since as described above they have the potential of playing in small groups and often get bored of the game, so they switch from one game to the next. There should be tables and chairs along with the small, partitioned areas/zones in the playrooms (Nikoloska, 2002; Stanković, 2009).

Children from 4-5 years or the middle group are organized into larger groups of three to five children. They perform their activities independently. Certain teaching activities are also

being set at this age. Because of this, in the playroom near the partitions, space should be left in one part where the tables and chairs should be placed. At this age, children, in addition to free games they choose themselves, they begin to perform some psychic activities on the tables and chairs, such as drawing, modeling, solving certain tasks (Stevanovič, 2001; Nikoloska, 2002; Stanković, 2009).

Children from 5-6 years old have good social interaction, getting prepared for school time, so most of the space is occupied by tables and chairs, where a certain teaching activity is performed through play, such as learning letters, counting, foreign language and more. The partitions should exist in the form of daily centers, each center for a certain activity. Due to the higher psychological development, better group cooperation and the ability to control their behavior, it is necessary to have less partitioned parts in the playrooms (Stevanovič, 2001; Nikoloska, 2002; Stanković, 2009).

The location of the centers is important for individual functioning, as well as for establishing harmony and balance in the room. Their proper organization and setting in the space leads to the space to be fully best equipped. The centers need to be set up correctly so as not to confuse the children. *Play and Sitting Surfaces*: Children love to sit on the floor; there they have more control of their bodies and can adjust their height according to their activity. We have to keep this in mind when setting up activity areas. Sometimes a table can be limiting. *Mood*: Children love contact with the outside, the nature. In order to establish contact with the nature, sufficient natural light and openness to it must be provided, in order to observe it from the inside, which has a calming effect on the children. *Storage and Display* are among the essential attributes of activity areas. These can promote independence and encourage the educational process by prolonging concentration, inhibiting distraction and encouraging child-initiated investigation. If materials are well organized and easily accessible, fewer pieces will be lost, there is less chance of spilling, and the frustrations of waiting are minimized. Place shelves at right angles to the walls, so that valuable wall space can be used for display. The backs of some shelves also lend themselves well to exhibiting children's artwork. *Time*: Children spend 6-10 hours a day, five days a week there. This is not a short period, and paying great importance on the formation of the personality, therefore the appropriate and quality way of arranging the space has a crucial role. Psychology Today published a study that about one-quarter of the children who spend more than 45 hours a week in daycare centers develop serious behavioral problems in later years, including aggression and hyperactivity. Interestingly, this seemed to have little bearing on the quality of the program (Mow, 2006).

Areas with open low storage shelves, cruiser centers, shatter-proof mirrors, child-size tables, chairs, and sinks provide opportunities for independent play, hygiene, and rest. A child should be free to play individually, with a small group, or with a large group of peers. Both environment and learning materials should promote self-confidence, self regulation, and self-control, and teach social skills such as taking turns and sharing. Infants learn self-feeding and self-care skills, while toddlers and preschoolers learn life skills such as tying their shoes, serving themselves food, and brushing their teeth. This is an opportune time to learn respect and empathy for others. It is also a prime time to obtain an awareness of aesthetics and instill a love for music, art, dance, and other artistic expressions. Nature walks and trips to the zoo and museums are extensions of the classroom which open young minds. As independent learners gain these abilities, they serve as a stepladder for further learning and development of a strong self-concept (Hernandez, 2010).

According to the above said, it can be stated that in the playrooms where certain parts are partitioned children behave better. As in preschool children social interaction is weaker, partitioned parts in space act favorably due to the fact that children can be grouped into smaller groups. The interaction between them lasts longer. They concentrate better and are more focused on the activity which is performed, become more independent because they have no need to call on the educators in case of a slowdown of activities. They are also not exposed to constant interruptions and observation by other children or educators. If the child feels the need to be alone able it can hide and to return to the activities later. According to many authors dealing with the preschool period of children, such as Altman and Stokols (1987), the need for withdrawal of the child to regulate the level of social activity is achieved if there is a space where they are sheltered and would remain in it for as long as needed to achieve a psychological balance. This psychological need of children to retreat to a certain part of the playroom does not pose psychological destruction, but simply the child requires a break from excessive interaction, to withdraw from a conflict or a little rest. After reaching the psychological balance, the child returns to the task it left or to another, which again starts the social interaction.

The partitioned zones in the playroom can be completely enclosed as separate rooms for a particular activity or partially enclosed, by way of furniture or toys. The completely partitioned rooms do not allow for a view of the rest of the room, and at the same time, educators do not have complete control over the children. As younger children need to be near the educators due to the attachment to adults, especially characteristic for this age group of children, they do not feel comfortable staying in fully enclosed parts. According to Nikoloska (2002), the

connection to adults of children aged 2 to 5 is very pronounced. When not at home, they express this attachment for their educators, and hence follows the above stated conclusion. Because of this interaction in pairs is small. In the partially separated parts of the playroom children have a wide view of the surroundings, even when educators are further away from them this does not interfere with their interaction, as educators they are within their sight. The barriers, due to the need of children to be connected to the carers or educators, must allow for a visual access from all parts of the playroom and this is accomplished by using transparent materials or the certain parts of the space that are supposed to be a separate area to have no visual barrier.

“Children learn through process, not product. Instead of providing toy castles, we want them to build their own castles. If you give a child something prefabricated, there is no process and there is no learning“ (Remenschneider, 2017). To create a space that is driven by the learning process, children need to be given full freedom in choosing materials, toys and didactic tools. This is achieved when the materials are placed on furniture elements that are easily accessible to children, on shelves that are at their height. It is also best to use cabinets that are open on both sides and have plastic sorting boxes on them. This allows children to have access to the materials at their disposal and to decide exactly which one to choose in the process of performing a task (Remenschneider, 2017).

In the playrooms where there are no barriers, children are more aggressive, social interaction is weak and they are focused on the educators. Children have no option for isolation if they need it, are exposed to views from other children and interruption in the process of an activity is greater. Unlike foundations that have partitions, in the playrooms that have no barriers children all not focused on the play itself, they do not initiate a certain activity, no discovery spirit is present, the behavior of children is accidental and they do not focus on a specific task for a longer time. According to Stankovic (2009), author of "Psychological aspects and design of children's preschool institutions", the playrooms of an open type suit the needs of infants at the stage when they start walking, in an educational model when the dominant role is played by an educator or when the goal is to achieve better management of the group.

According to the type of games, they can be divided into so-called "clean" games and "dirty" games. Dirty games include those where, after finishing, children need to wash or use water during the game, as in modeling dough, plasticine, and the like. Therefore, a certain part of the playroom needs to be separated for this activity, and to have sinks in the immediate vicinity.

In the research that has been done for the needs of this paper, it can be seen that the situation in Skopje and Sofia is not satisfactory. The playrooms have no activity centers and are not divided into smaller corners. The playrooms are fully open, in the middle there are tables and chairs or free space where there is nothing. Also, in most preschool facilities, the cabinets are too high and children cannot freely reach objects. In Zagreb the situation is a bit different, the playrooms are divided into small corners, the cabinets are fully adapted to the height of the children, but in some of the buildings the centers are such so that chaos occurs in the room, they are confusing and do not have a clear indication of the purpose of the centers (Figures 53, 54 and 55). “Children play with each other much more when the zones, the centers are connected and clear than when they are separated” (Liempd, 2006).



Figure 53 a, b, c. Examples of spatial organization in Polygon I. Open space without partitions.

Photo: Iliev, 2017



Figure 54 a, b, c. Examples of spatial organization in Polygon III. Open space without partitions.

Photo: Iliev, 2017



Figure 55 a, b, c. Examples of spatial organization in Polygon II. Space with a partition.

Photo: Iliev, 2017

Space organization and the design of the playrooms are an important factors in children's mental maturity. They should not only be pleasing to the eye, but also to have a purposeful function to children growth. When the space is well organized with open paths that clearly lead to the activity centers, the children can deal with a certain activity or game on their own. They

can move freely and be redirected from one activity to another, or from one center to another, without the need for the presence of a teacher's conducting a certain activity. When space is poorly organized, children depend on the teacher for guidance and the teacher's behavior becomes directive. When teachers spend a great deal of time directing group behavior, they have less time to assist individual children and children have fewer opportunities to participate in free play. When the space is not well organized, the children depend on the teacher's tasks. For example, after an appropriate change in the environment such as the addition of a complex or super play unit, children may engage in more free play, exhibit greater self-reliance, or develop longer attention spans (Colbert, 2006).

As a result of Kirova (2006), boys are more prone to untidy rooms, and they feel comfortable in that mess, while girls want to be in a little tidier area "everything in its place." Boys also prefer a space that has more shapes and constructive elements, and girls prefer a more colorful part with more color movement. There should be no specific division that would separate male from female children. An integrated space containing these two components can be arranged, a variety of colors and constructiveness of lines and shapes.

6.7.1. Behavioral and educational activities regarding kindergarden's environment

According to all given results and observations, the huge problem in the most kindergartens are the environmental design and quality of the usage of space, both in playrooms, or the whole kindergarden's facility. Space (or environment) in which the children reside is conceived depending on the type of educational and behavioral activities. These activities are characteristic for the groups of kindergarten especially children aged 5-6. They are grouped in the central part of the playroom and most of the time for these activities is used in a group interaction aimed at teachers, working on tables and chairs. Thus, the playrooms for the intermediate and older group need more space allocated to the part where tables and chairs will be placed, while not neglecting the parts that are partitioned, but to a lesser representation from the playrooms of other groups. In case of a physical activity then the same space is used, where are tables and chairs are placed, so they are moved away to get a completely empty space. Therefore, tables and chairs should be easy to maneuver by the children themselves, so they can be able to move freely through space. Easy maneuverability on this type of furniture also leads to a certain grouping of the children, if so required by an activity.

6.7.2. Other parameters affecting the modification of the space – playroom

According by researching, talking to teachers, and observing children's behaviour this several claims were made. The room in which the children reside should be flexible in terms of furniture and partitions that are in it, so that they can be moved by the children themselves. Children feel comfortable in space in which they have control, i.e., when they can freely move elements around it. This helps the children fully fit in the space, to explore, create new, small spaces suitable for their activity. If the space is completely static, then insecurity arises in children and they are less independent. The space should also be clear, which means that every part of the playroom clearly indicates for which function it is intended. If the space is chaotic the children will be disoriented, and any activity will be performed with less capacity because they can not discern the space clearly enough. In this context, the communication facilities the whole environment (space) should also be clear and concise to avoid disorientation. This can be achieved by inserting color in the corridors themselves as well as on the walls and the floor surface. Moreover, space should be visually accessible, because for children, although at certain times of the day they wish to withdraw in some part or play in smaller groups, the visibility is still very important (Figure 56 and 57). On the other side, visibility is also good from the point of view of safety, as carers have constant supervision of the children. Visual access, besides except in the playrooms, should also be present in other areas used, such as the wardrobe area, toilets or communication facilities.



Figure 56 Colorfull corridor
Source: web 15



Figure 57 Example of corridor, before and after.
Source: Dudek, 2008

According to Nikoloska (2002), an important factor for social interaction is the size of the premises as well as the resources therein. If the playroom is too small this increases aggressiveness and emotional excitement. In rooms that are too spacious, children can be "lost" if the space is not properly organized. Toys also affect the interaction of children, e.g. each

child has its favorite toy at a certain period of the day. Contrary to this, if there are fewer toys, children are more in a position to socialize with each other, i.e. social interaction increases.

A very important factor affecting whether children will accept the space where they reside, is whether they consider it as their favorite spot. It is known that they feel relaxed and positively respond in familiar spaces. Hence, playrooms should be functionally designed, just like their homes. To know exactly where to eat, where to sleep and where to play. The space should be plastered with their drawings or objects they have made in kindergarten (Stanković, 2009), using varied, but delicate colors. This is done in order to make it easier for them to accept the space. This way, they connect to a space that provides a comfortable, safe, and cozy atmosphere and a space that offers full "mystery" they can constantly explore and where they would want to return. The exploration could be encouraged, for example, by adding houses in which children can enter and climb (see the chapter 6.13., new ideas and visions). This is achieved by adding various elements in space, by placing a net of interesting forms on the walls at different levels, etc. This type of equipment and elements in space can be placed in the playroom of residence or in a separate area intended for such activities. It can also be the space for multiple purposes.

The area where children stay under the above given analyses should include all segments where the child can perform various activities in a certain part of the day, that is to be complexly structured. That means it should contain all the features that support the proper physical and mental development of the child.

In terms of the physical development of the child, despite meeting a certain size, the space also should be flexible. This means that if some more dynamic physical exercises occur, they should be held in the space allocated for it, such as the multipurpose hall or the yard. If such space is not available, meeting only the psychological component is not enough, because the progress of physical activities under the supervision of a trained person positively influences the healthy development of the child body.



Figure 58 A playroom divided on small zones

Source: web 13



Figure 59 Clearly defined spaces eliminate chaos.

Source: web 14

From the answers received from the surveys of the staff in the kindergartens in the three location, it can see the current situation in the playrooms, their vision for them, whether they are satisfied or not with the spatial organization and whether they pay attention to it at all.

When asked what type of activities you most often apply: in *large groups* the answer was of a total $N_t=34.9\%$ ($N_{so}=13.3\%$, $N_{sk}=74.8\%$ and $N_{zg}=4.1\%$); in *smaller groups* was the answer of a total of $N_t=12.4\%$ ($N_{so}=4.1\%$, $N_{sk}=12.8\%$ and $N_{zg}=21\%$); individually was the answer of a total of $N_t=12.2\%$ ($N_{so}=0.5\%$, $N_{sk}=25.7\%$ and $N_{zg}=7.6\%$); and all types depending on the given task answered by a total of $N_t=48.7\%$ ($N_{so}=82.1\%$, $N_{sk}=5.0\%$ and

Nzg=69.7%) (Table 43). In Skopje, they usually have activities in large groups, so the playrooms are of an open type. In Sofia and Zagreb, activities are performed from all perspectives depending on the work process. Observing the interior in Sofia, from the point of view of furniture layout, it can not be stated that the work process takes place according to the given answer. In Zagreb, it can be stated that the type of activities with the children is somewhat consistent to the spatial organization. „When you walk into a well-designed preschool classroom, you see children and adults working together in a productive surrounding. There are children constructively engaged and teachers busy observing, facilitating, and challenging the children. The environment supports all this by assuming several of the responsibilities we typically associate with teachers. It helps the children interact, learn, and avoid unproductive activities, such as running and getting in each other’s way. Thus, the environment actually becomes another teacher in the classroom. Careful attention to these elements reduces how much time the teachers spend maintaining safety and order. This frees up time for higher levels of teaching, which ultimately increases learning“ (Klein, 2014).

According to the results, kindergarten staff believe that the playrooms "correspond to the size of the dimensions", a total of Nt=54.1% (Nso=74.1%, Nsk=37.1% and Nzg=52.8%); "too small" considered by a total of Nt=26.9% (Nso= 24.9%, Nsk=18.5% and Nzg=42.4%) and "too large" by a total of Nt=19% (Nso=1%, Nsk=44.4% and Nzg=4.9%). In terms of furniture, they consider that the current situation is good, a total of 34.6% (Nso= 29.3%, Nsk=27.1% and Nzg=53.5%); it has more furniture than it needs by a total of Nt=12.9 (Nso=4.5%, Nsk=16.1% and Nzg=19.4%) and it has less furniture than it needs by a total of Nt=52.5% (Nso= 66.2%, Nsk=56.9% and Nzg=27.1%) (Table 44).

To the question: "How should the playrooms look in terms of special organizing"? (devided with furniture), considered by a total of Nt=19.9% (Nso=28.4%, Nsk=22.1% and Nzg=4.9%); divided into several small functional units, i.e. furniture centers that correspond to these centers, considered by a total of Nt=21.3% (Nso=12.6%, Nsk=20.3% and Zagreb 34.5%); one part of the space to be open, while the other part to be with functional centers, considered by a total of Nt=22.6% (Nso=28.4%, Nsk=10.6% and Zagreb 33.1%) and a polyvalent space in which the centers that correspond to the current work task can be created together with the children, considered by a total of Nt=36.2% (Nso=30.5%, Nsk=47% and Zagreb 27.5%) (Table 45). Kindergarten staff are *somewhat satisfied* with the way the playrooms where they work are being arranged (Table 52). They also think that to *some extent* they have enough space for free movement through the playrooms (Table 52). According to Klein (2014), there are four main

factors in creating an environment that enhances the learning process while arranging a space. In addition to children's well-being (safety), it should be observed how the materials present should encourage learning (*set-up*), that is, how toys, materials and didactic means are placed in the space. The perspectives of those who will use the environment (*culture* – to increase the comfort for example e.g., pillows, baskets, curtains, and cushions), a very important element is the proper *zoning* in the space. The playroom should be divided into variety of group sizes and configurations: small group time, large group time, individual time, one-on-one with a teacher, and time to work with a partner (Klein, 2014).

According to the placement of certain functions performed in the playroom, the staff have an opinion that the sleeping or resting place should be placed in a separate room, considered by a total of $N_t=83.6\%$ ($N_{so}=95.3\%$, $N_{sk}=90.4\%$ and $N_{zg}=59.3\%$), while a total of $N_t=13.2\%$ believe that the sleeping place should be in the same room where the daily educational process takes place. In Sofia and Skopje, over 90% of teachers said they preferred a separate room as a sleeping place. This answer is logical due to the fact that the daily making of the beds, especially in Skopje presents a big problem. In Zagreb, over 50% of the teachers prefer a separate sleeping place. Here the percentage is lower due to the easier manipulation with the beds or mattresses.

According to whether the food should be served in the same room where the daily educational activities are performed, the opinion is divided, a total of $N_t=39.8\%$ ($N_{so}=42.3\%$, $N_{sk}=29.1\%$ and $N_{zg}=52.8\%$) consider it should be served in the same room, and a total of $N_t=48.2\%$ ($N_{so}=53.1\%$, $N_{sk}=49.5\%$ and $N_{zg}=39.6\%$) consider that it should be served in a separate room. According to Stanković (2009), if the food is served in another room, it may have a negative impact on the children, due to the loss of the home atmosphere to which they are accustomed, because they feel better in the same, unique space in which they perform all the activities. The children's toilets "should be placed next to the playroom" considered by a total of $N_t=85.1\%$ of the kindergarten staff ($N_{so}=30.5\%$, $N_{sk}=47\%$ and $N_{zg}=27.5\%$). When designing this type of buildings, the opinion of the staff must be considered, in order to facilitate their daily work (Table 51).

On the floors in the rooms where children spend the most of the time, there should be: parquet, according to a total of $N_t=20.4\%$ of the teachers ($N_{so}=19.3\%$, $N_{sk}=23\%$ and $N_{zg}=17.9\%$); combined carpet and parquet, according to a total of 64.5% of the teachers ($N_{so}=61.4\%$, $N_{sk}=64.8\%$ and $N_{zg}=68.3\%$); linoleum, according to a total of 8.1% of the teachers ($N_{so}=10.2\%$, $N_{sk}=6.1\%$ and $N_{zg}=8.3\%$); carpet or rug all over the surface or ceramic

tiles according to less than 4%, (table 45). In the mosaic method, from the 5 offered answers for different types of floor (linoleum in different colors and shapes 3/36, ceramic tiles 0/36, polyester tiles that are assembled in different colors 8/36, parquet 4/36 and sponge with uneven surface in different colors 21/36 (Figure 23). Most of the children pointed out a floor covering that has unevenness and is in different colors. The answer is logical due to the fact that children always choose things that associate them with game, and at the same time increase their imagination. At the same question number 2 on the Questionary that was asked in different time periods in kindergartens in the Czech Republic and Croatia (Dijanošić, 2019) most of the children answered under alinoleum), c (polyester tiles that are assembled in different colors) and e (sponge with uneven surface in different colors) (same answers). With this, it can be stated that the surface softness of the floor material and the different colors attract the children's attention. In the study of Abramson et al. (2006), 41 kindergartens in three different cities (Birmingham (AL), Detroit (MI) and Houston (TX) in USA) were examined, where they were analyzed by collecting dust. Four samples were assayed for dust mite allergens, *Dermatophagoides pteronyssinus*, *Dermatophagoides farina*, cat allergen *Felis domesticus* and cockroach allergen *Blattella germanica*. Dust mite allergens proliferate in warm temperatures and high-humidity areas, also dust mite were high in schoolrooms with carpets. Therefore, it can be concluded that hygiene is also a very important factor. In the playrooms where there are carpets, regular and thorough disinfection is needed, unlike other floor coverings (Abramson et al., 2006).

When asked "should teachers have some kind of education by experts related to the application and use of children's furniture", a total of 20.8% of the teachers confirmed (Nso=35.4%, Nsk=15.5% and Nzg=9%); a total of 46% answered negatively (Nso=37.9%, Nsk=41.8% and Nzg=63.4%); a total of 33.2% of the teachers do not know (Nso=26.8%, Nsk=42.7% and Nzg=27.9%) (Table 51). Such an answer to this question is expected and logical because teachers in addition to the daily responsibilities they have in the teaching process with children, accept this as an obligation more, for which they consider themselves not competent enough. What type of furniture is most suitable for preschool children, what material it should be made of and whether it meets all the elements that it should have is a question that should be answered by a team of interdisciplinary experts.

The physical environment can either contribute to children's development and support staff and parent goals or create a permanent impediment to the operation of a high quality program. Designing a high-quality, developmentally appropriate child care facility is a highly

complex task which requires specialized and unique skills. The design and layout of the physical environment, which includes the building, interior finishes, outdoor spaces, selection of equipment and room arrangement has a profound impact on children's learning and behavior and on teachers' abilities to efficiently do their jobs (Stoecklin, 2007).

6.8. DISCUSSION REGARDING OF MANUFACTURER'S SURVEY RESULTS

The respondent manufacturers - distributors of preschool furniture in the answers in the survey give their suggestions, opinions and comments related to the process of designing the furniture as well as in the process of public procurement of the furniture. Their answers, as well as the analysis of the answers helps to predict and define certain trends in the design of preschool furniture, and on the other hand the commitment to improve the overall process of conducting public procurement of furniture:

- Companies (5/12) generally participate in the public procurement process for equipping kindergartens, while they are constantly reporting (3/12), the rest occurring sometimes (2/12) or never (2/12).
- Companies apply in the public procurement process because: (7/12) have all the required elements according to the documentation required from them and can be competitive with the price of their products; (4/12) possess all the required elements according to the documentation required from them and can be competitive with the quality of their products; (4/12) have started cooperation with preschool institutions.
- (8/12) of the companies know that they should use European standards in the production of preschool furniture, while (4/12) do not know that it should be used.
- (11/12) of the companies replied that the price should not be the only condition when buying furniture through public procurement.

Regarding the overall process of public procurement, the companies provided the following answers and suggestions:

- All the companies except one consider that they *are generally satisfied* with the description of the tender specification of the required goods.
- The companies are *generally satisfied* (10/12) with the guidelines themselves and the specification in the guidelines given in the tender specification for the goods used. Only two companies *are generally dissatisfied* with them.

- The companies consider that the tender documentation should state: (5/12) the exact dimension and details of the requested product, then (8/12) consider that there should be detailed descriptions of the product that is required. Companies also believe that the tender specification for the goods in demand should be improved in terms of: it should contain the exact dimensions of the product required (4/12); detailed specifications of the form and shape of the furniture with attached drawing (7/12) and; detailed product characteristics described (6/12); and detailed description of quality characteristics (2/12).
- From the process of opening the tender documentation (5/12) of the companies consider that they are *satisfied*; generally satisfied (4/12) and *generally dissatisfied* (3/12)
- The surveyed (5/12) of the companies consider that the members who participate in the tenders for the public procurement are comprised of professional staff; this opinion is not shared by (2/12); (4/12) do not know. Despite the answer that they are mostly satisfied with the expertise of the members, the companies believe that the process of public procurement should include experts in the field of architecture 7/12, experts in the field of wood technology 7/12, as well as experts in medicine and quality.
- The companies consider that they lack a detailed guide or rulebook for equipping kindergartens (6/12) or that the existing ones need to be modified or renewed (3/12).

From the obtained answers it can be seen that the very process of public procurement of the products for equipping the kindergartens should be improved and completed, so that in the future there would be no confusion and mistakes. Legal and other bylaws, rules and regulations should contain clear and unambiguous and precise provisions in order to point to an accurate description of the type of products in the tender procedure, to contain precisely defined dimensions, appearance, shape, use of specific materials and other characteristics which individually determine the required product. In the conversations with the staff in the companies, the most common problem is when the demander (the principal or the teachers in the kindergartens) asks for a specific product, but they do not know how to describe it, specify it and explain it, so that later they express dissatisfaction with the product that has been produced. Therefore, professionals and experts should be involved in this whole process, which would avoid problems of this kind, i.e. to minimize them.

- The companies (7/12) make procurement / production most often of more than 6 products (chairs, tables, beds, cabinets, didactics ...); also (7/12) of the companies claim

to use the group of EN 1729; while the rest use some others or do not use norms at all. The companies are satisfied (5/12), or generally satisfied (7/12) with their products.

- The companies (10/12) consider the design to be one of the most important elements in the process of producing preschool furniture; The design in the companies is prepared by a designer (4/12), an architect (3/12), a wood technologist (5/12), a graduate mechanical engineer (2/12); With the current design of the preschool furniture (5/12) are satisfied, (3/12) are unsatisfied, to some extent satisfied are (2/12), do not know whether they are satisfied or not (3/12); To improve the current design (3/12) would change the look (the shape), the construction or material (3/12), the overall design concept (2/12), don't know (4/12).
- (8/12) consider that the size of the chairs and tables is adjusted to the age of the children, while (2/12) consider that it is not harmonized, the others do not know.

6.9. DISCUSSION ON CHILDREN DRAWINGS AS A PART OF MOSAIC METHOD

When designing furniture and interiors, children should be listened to and thought about, because they know and feel the most about what they miss, what they would like to have in their own playroom or what they have more and what does not suit them or limits them. In order to understand the attitudes and needs of the children, the Mosaic method was implemented in cooperation with the teachers. One of the tasks was to draw their own playroom from their dreams. This method was performed on children from 6 years of age and in the preschool group.

On the figures 60-67 illustrations are given from the children that has drawn the playrooms of their dreams. Attention should be paid to the details of the drawings such as: the use of colors, colorful carpets, joyful colors on the walls, posters with their favorite heroes on the walls, many toys, small game houses... Furthermore, it is a positive finding how aware the children have been in terms of the inappropriate and unobtrusive appearance of the classroom (wishes such as: beautiful curtains, beautiful and colorful chandeliers, colored carpets, with animal motifs (in the form of fish or geometric motifs), and the old and ugly furniture that comes with it: uncomfortable (unstable broken chair... needs such as shabby furniture, soft chairs, armrests, lift button chair, etc.).



Figure 60 Children's drawing 1

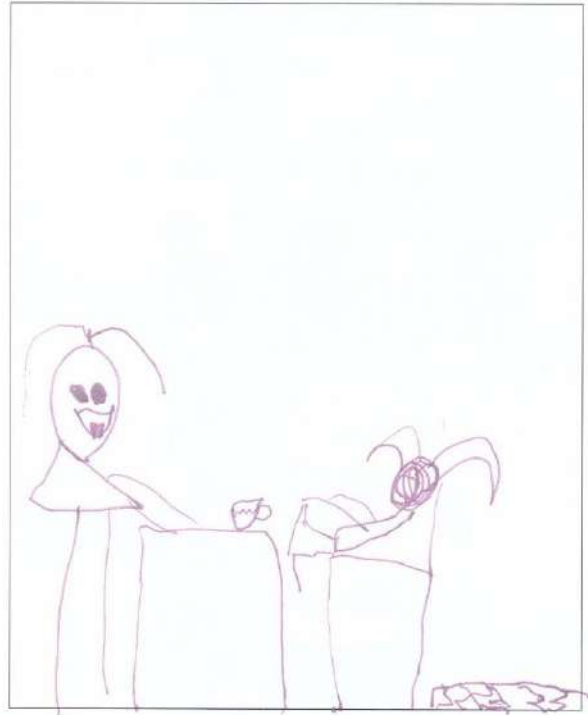


Figure 61 Children's drawing 2



Figure 62 Children's drawing 3

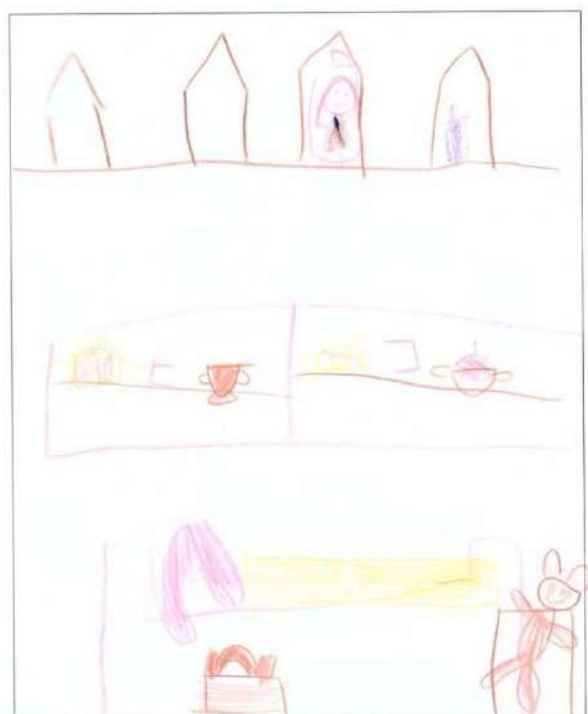


Figure 63 Children's drawing 4



Figure 64 Children's drawing 5



Figure 65 Children's drawing 6



Figure 66 Children's drawing 7

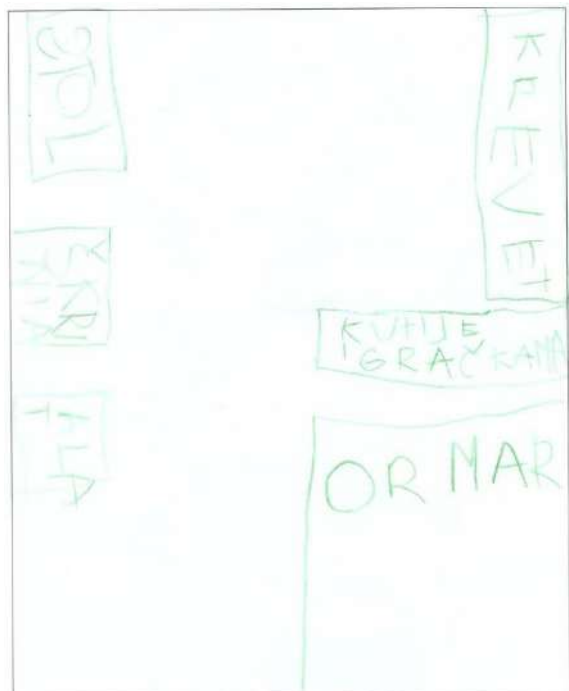


Figure 67 Children's drawing 8

6.10. DISCUSSION ON THE ANALYZED RESULTS

The furniture used in the preschools is a sublimation of knowledge from many areas. For suitably designed furniture of this type, many factors are important. Several conditions need to be met (Bajbutović, 1983; Grbac, 2003; Neufert, 2003; Grbac, 2006; Domljan, 2011), such as:

medical, avoiding fatigue, free movement and movement of the body. The pedagogical requirement means that the furniture should be adequately constructively and shapely designed to be fully adjusted to the educational process. Ergonomic-anthropometric, constructively economical, ecological, aesthetic, are the other necessary factors that preschool furniture should contain to fully satisfy the conditions for its utilization.

The comprehensive approach to designing furniture for kindergartens is not conditioned only by the process of its design, but also by all the stages it goes through to reach the final consumer.

One of the main problems in the procurement of furniture, which has an impact on production, is the fact that the furniture used in preschool facilities must be procured through public procurement, and free choice is limited since the specifications are prepared in such a way that the choice is usually directed to only one criterion, the lowest price of the furniture. This means that the financial factor is crucial in the procurement, and all the other are neglected. In addition, each municipality does not have the same financial resources, so considerable differences are obvious. Another problem when purchasing furniture is the insufficient and scarce number of appropriate guidelines. Recently, only in Croatia exist a manual for equipping educational institutions, where all the parameters of what the furniture should look like and be designed are comprehensively processed (Domljan et al., 2015). Also, in the regulations for preschool activities, the appearance of the furniture is described very generally. The details are undefined, which leads to great diversity in the design process of the investors, manufacturers and others involved in this process. Due to the lack of rules and norms for furniture and equipment, it often remains unspoken, accelerated and deficient in the quality of the users' needs (Domljan et al., 2015).

Without well prepared rulebooks, guidelines and standards, with very clearly and unambiguously established parameters, one can not reach a quality solution to the problems in planning, design and construction of furniture for preschool institutions. Hence, the lack of a clear boundary as to which age group can use appropriate furniture leads to the design of furniture not according to professional criteria, but according to the wishes of the principals of preschools or furniture manufacturers. This leads to the production of cheap shape-wise and construction solutions. Uniform furniture costs less, it is sold more easily and at a lower price, and temporally coordinated production does not require new investments in fresh constructive solutions and design shapes (Domljan, 2011). Some of the chairs analysed in the study of Domljan (2011) have not changed their shape in more than 50 years. Hence, when procuring

furniture, what is more important is satisfying the number of pieces of furniture rather than their practical and ergonomic purpose.

The results obtained stimulate thinking that the designers or architects who are to create the design are not necessarily aware of the children's needs, pedagogical standards, and psychological needs. Many times architects and designers create designs that look good aesthetically, but are not functional and practical. „When designing furniture, very often the users are not consulted directly, for example, those users for whom this furniture has been intended. In the survey conducted in the kindergartens in Zagreb, 90.7% of the respondents said that they had not been consulted by architects or designers, and 83% said that this communication between architects and those working in kindergartens is very important (Burić, 2006). Very often, preschool buildings are being built to look more like a decoration rather than to look like a functional unit that they have been intended to be. The more money spent on the exterior look of a building the less money remain for furniture and the elements needed for a spacious organization. In the case of wrong designs, children cannot adjust as easily as adults (e.g. Stoecklin (2007) emphasised “if the washrooms for children are too high they become unusable, if they are too low children can start climbing up on them”).

When designing kindergarten furniture, pedagogical tendencies should be followed, and a well-designed product can easily allow the space to be organized thus that modern pedagogical and psychological standards are met. When designing this type of furniture, one should consult the staff of the kindergartens, so that the furniture would be practical and at the same time to consider the psycho-physical development of the children. It is often the case that the staff do not know well to express or explain their knowledge and experience in view of what type of furniture they prefer and need in the playrooms. Therefore, a good communication is needed between the different structures.

6.11. NEW APPROACH FOR DEVELOPMENT OF THE FURNITURE FOR KINDERGARTENS

Preschool furniture represents an integral and inevitable element in the architecture of preschool facilities and a compulsory segment of the environment of the preschool institutions, with a significant influence on the educational and development process that takes place in them. The preschool table and chair, on which the research was focused, are only a small segment of the preschool environment, which contribute to a sense of satisfaction or discomfort, concentration, acceptance, rejection... creating a positive or negative environment for learning and stay. For the purpose of quality design and performance of the overall design in preschool

facilities, all the elements that children and teachers use or with which are surrounded should be defined. Doctors, psychologists, sociologists, pedagogues and other professionals point to the great importance of the fact that the circumstance when a person feels comfortable and has a sense of satisfaction and success has a positive impact on his health. All this can only be achieved when furniture, other equipment and surroundings in preschools are appropriate and adapted to their needs, in scale and proportions consistent with child's anatomy and body.

Many factors influence the achievement of a good design of preschool furniture and environment in kindergartens. They are described and commented in many papers and almost all of them mention the need for their interdisciplinary approach to the complete process of shaping the product. The design of preschool furniture represents the interaction of a great deal of knowledge from other scientific fields such as pedagogy, medicine, design, architecture, economy, ecology, ergonomics and many more. The factors influencing the development of preschool furniture and the pedagogical process are the discoveries and new solutions in the field of wood technology, new design solutions, new materials, the impact of technological development in other technical areas, socio-political events, the improvement of technical standards and the quality of production, the development of the curriculum, the influence of fashion, the impact of globalization and many more.

Designing an optimal place for working for children in kindergartens is a responsible task for all participants, mostly due to the fact that in the pre-school period the child's body experiences the biggest changes, which is conditioned by the rapid growth and development. Deformations and irregular body growth in this period can have lasting consequences for the human organism, following it for a lifetime.

The defined requirements with elaborated product or product assortment criteria is the basis for the designing solutions, illustrated by sketches and drawings. Different concepts in creating design solutions are different in form, constructive solutions, application of materials and the technological process in their preparation. As a result to this, the furniture either needs to be redesigned or new innovative solutions should be created (see chapter 6.13.).

The goal is to create furniture, which will be fully designed according to the needs of all users: children and teachers, but also to all those who participate in the educational process, where they would feel free, comfortable, creative and healthy. Withal, their action in the space would be directed towards a complete positive development both of the individual and collectively.

6.12. PROPOSAL OF A NEW PURCHASING METHODS/PLAN

The plan of the new proposal for a purchase of the kindergarten furniture could take place in several stages:

1. Creating a team. To choose a multidisciplinary team; To participate a certain number of children who are direct users of the furniture, equipment and the overall environment in the kindergartens; To be involved - interviewed teachers and nurses from kindergartens who can recommend out of their everyday and long experience and knowledge good ideas and solutions; To be consulted employees - doctors in health institutions, engineers in the field of wood industry or furniture designers; The employees in the state and local government as the main stakeholders should also express their opinions through the public procurement of furniture selection in pre-school institutions; Consultation with furniture manufacturers.
2. Defining the need for new furniture. Introducing all members of the team with the need for a new kind of pre-school furniture. Warning about the current situation of existing furniture and its negative impact on children. Defining the educational process (the different type of maintenance of daily activities also requires appropriate furniture).
3. Creating a vision. Description of the curriculum and a programme for kindergartens through which real insights about what type of furniture is needed will be gotten. Drawing and textual description of future furniture by creating an eventual new form, materials, method of use, maintenance.
4. Implementing the plan. Providing technical support to the whole team. The biggest problem could arise from the attitude of the traditional and solid attitudes of the teaching staff in the implementation of creative, free and advanced ideas; the rigid bureaucratic system that does not have the willing or desire to change the rulebooks and the surmounted, non-complied with reality standards; inadequate application of the existing standards in the furniture design; the lack of anthropometric data for pre-school children; ignorance and inertness of the manufacturers in designing innovative products - furniture, which will stimulate creativity and dynamism; lack of understanding of the need for financial support for new solutions at the national (state) level and the like.
5. Valuating the plan. Monitoring the progress of the plan and changing the steps if necessary.

6. After sale monitoring and noticing the impact of the new environment on the behavior of children and teachers.

The persistence, courage, impetus and the challenge for new research open the possibility of creating another, different setting in pre-school institutions, with the ultimate goal of creating a healthy young generation that is full of physical and mental health.

6.13. NEW IDEAS AND VISIONS

Designing the furniture and interior of a playrooms are complex process. As a designer, the starting point for solving this problem are children. Everything else in the environment is just considered parameters that must support the child and his growth and development.

The design in its essence means the shaping of products that arise by reaching a compromise between manufacturers /distributors and users. Since the final design of the products is influenced by a multitude of factors, the designer must cooperate with professionals from different fields: ergonomists, technicians, technologists, constructors, market researchers, managers, businessmen and others. It represents a teamwork in the design process, with the design itself directly linked to the overall development of the product.

The question of what a good design can be given a principled answer: a good design is an achieved compromise, an interdisciplinary cooperation and a synthesis of the problem (Domljan, 2011). The design is the solution to the overall problem in the process of creating, not just solving the shape of the design.

The conceptual solutions are obtained in response of the research results. Observing the motorical and psychological activities of the children, the play process, the conversation with the teachers and the professional staff like psychologists and pedagogues, lead to the creation of some conceptual solutions. The psychological aspects that affect the development of the child are taken into consideration, such as giving complete freedom in the process of play, through which the child develops and learns best. On the other hand, from the obtained results, the child feels safe, develops when he can act freely and fantasizes in a space in which there are abstract elements related to the flora and fauna, elements from children's fairy tales. The classic way of arranging the playrooms with a central place on the tables and chairs in which the teacher has the main role is already an outdated model. A space should be provided in which children will have the freedom to choose which activity to do, complemented by interiors and furniture that will allow them to be more creative.

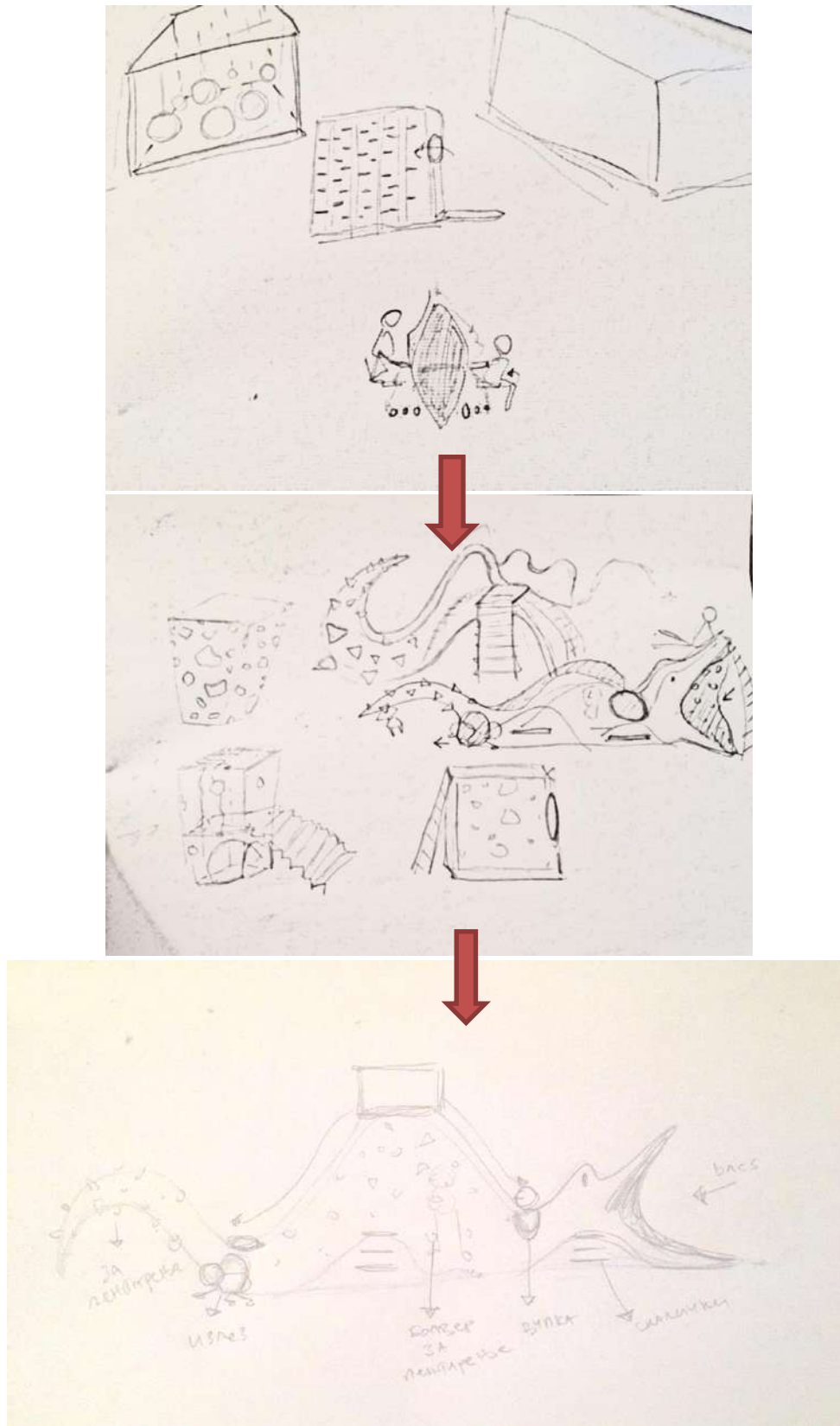


Figure 68 Sketches of the dragon (multifunctional furniture elements).

Steps when sketching a dragon

Drawings by author.

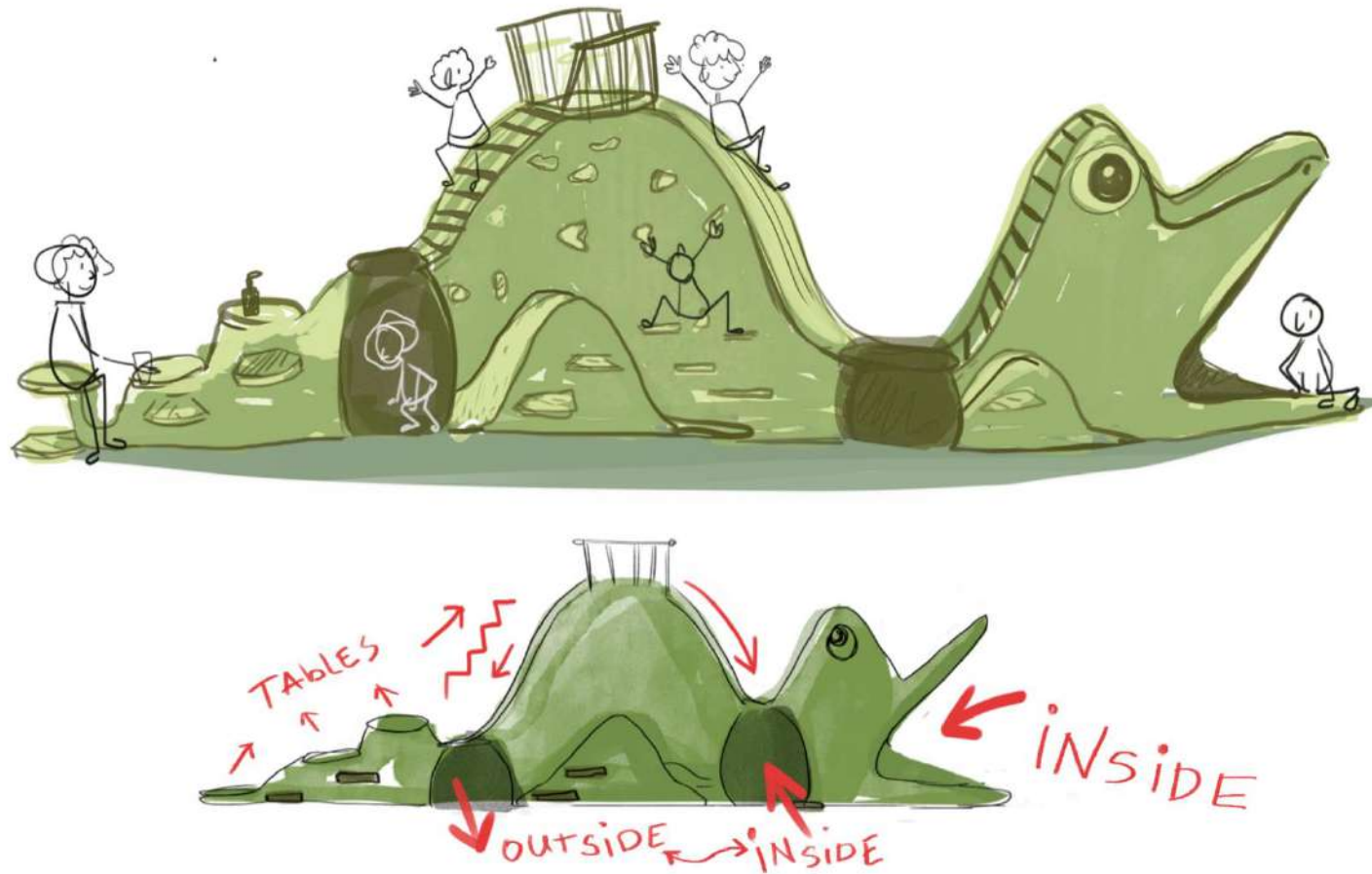


Figure 69 Dragon, multifunctional furniture element for play and work.
 Concept by author, drawing by Sanja Simoska, 2021

A dragon inspired by children's fairy tales. The dragon is a multifunctional piece of furniture in / on which children can play. The game consists in the fact that they can climb on it, slide, enter it. On the tail there are tables with chairs, so the children can draw and eat. The dragon is placed in the central part of the room.



Figure 70 Table ladybug.
Drawings: by author, 2021
Table in the shape of ladybug. Inspiration from nature, faunas.

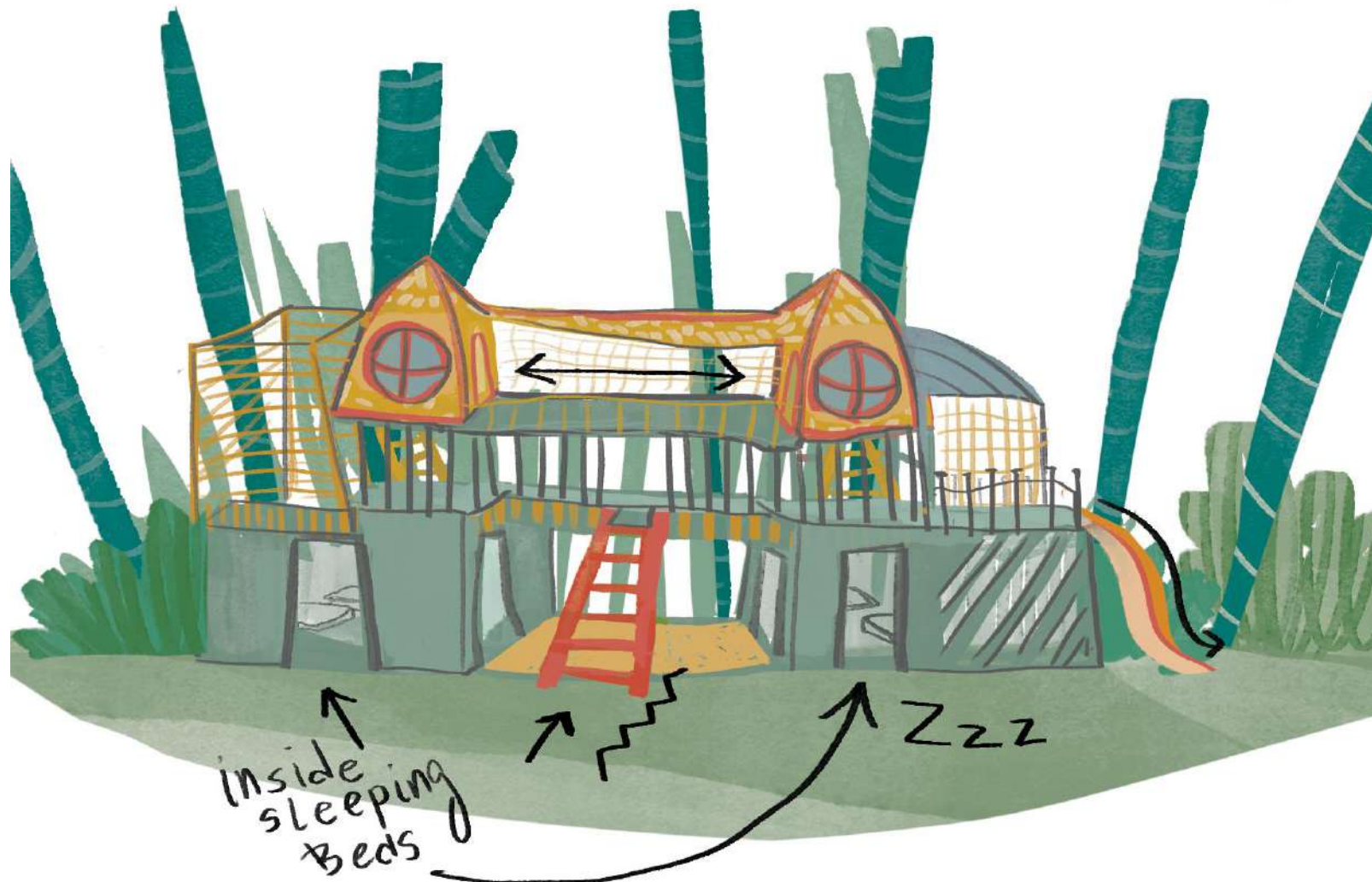


Figure 71 Castle- a multifunctional piece of furniture for playing and sleeping.
Concept by author, drawing by Sanja Simoska, 2021.

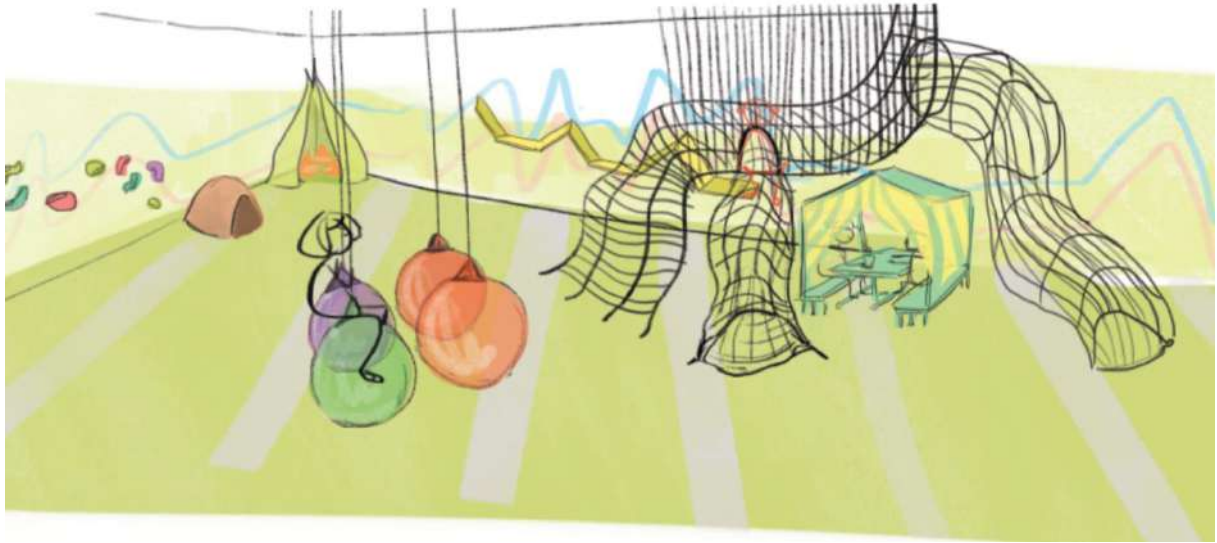
Castle - a multifunctional piece of furniture inspired by children's fairy tales. The castle is on two levels. On the lower level there are small sleeping rooms with openings in various shapes on the walls. On the second level there are nets for climbing skates, tents and tunnels. Around the castle there is a jungle in which there is a variety of fauna



Figure 72 Conceptual solution of playroom.

Concept by author, drawing by Sanja Simoska, 2021

A playroom with no tables or chairs. The interior is accentuated by the free movement and activities of the children. There are climbing nets along the entire length of the room. On the walls there are climbing hold. Each child can independently choose whether to rest, play or perform some type of activity.



A



B





C



Figure 73 Interior design of playroom.

Concept by author, drawing by Sanja Simoska, 2021

Playroom with more content for activity. Tables placed in group of 4 and looks like houses. The same construction has beds, too.

7. CONCLUSION

Kindergartens, a preschool institutions, are facilities in which educational and care activities are performed. The design framework of these facilities is strictly controlled and limited in advance by the many functions performed in them. Kindergartens should be a place where special attention should be paid to the health and safety of the children, as well as ensuring proper social and educational development. When designing, arranging and equipping these facilities, attention should be paid to the needs of the children. Therefore, the (play)rooms where the children stay, should be in the function of the child himself. One of the main preconditions for the proper functioning of the preschool institutions are the spatial organization and furniture design. All the functions should be understandable inside playrooms, also should be clear and unambiguous.

Based on the conducted research, conclusions were made with regard to the set hypotheses and objectives of the research. The results of the research achieved the following goals:

O1: It was found that the current furniture with which children come into daily contact in kindergartens in three different countries is not suitable for healthy growth and development of children, from the point of view of design, functional dimensions prescribed by applicable standards, use of wood and other environmental materials, safety and other criteria.

O2: Basic requirements have been established for the design and equipping of kindergarten furniture, which has given impetus to further research and the involvement of professionals from several different scientific fields.

Also, the hypotheses of the work were confirmed:

H1: Furniture used by children in kindergartens does not meet the requirements of modern pedagogy, design, quality, safety, ergonomics and sustainability, as evidenced by the results of measuring and comparing the dimensions of furniture and children, educators' answers in the questionnaire and observing and photographing children's body position on used furniture.

H2: It is possible to define new modern requirements and criteria for product design and quality, and thus create preconditions for maintaining children's health (as shown in Chapters

6.12 and 6.13, where new guidelines for furnishing and ideas for furniture design in buildings for preschool education that create the foundations of healthy child growth and development).

Additionally, following can be determined and concluded in details:

1. The dimensions of the furniture do not correspond to the anthropometric measures of the children, which is confirmed within all the types of furniture, for all age groups. There is a lot of inconsistency and deviations. Tables and chairs are either larger or smaller. Improperly designed furniture in this way has the most direct, negative effect on the psychophysical development of the children. As a result, an incorrect posture, back and neck pain, fatigue, and loss of concentration may occur.
2. The use of contemporary and for the children appropriate furniture in means of dimensions and proper use of furniture requires active and ongoing education of the staff in kindergartens.
3. The furniture that is used in whole does not meet the pedagogical standards and is not in accordance with the new modern needs in the teaching process. Although few of the teachers show a certain awareness and understanding of the inappropriate environment, in most of the respondents there is a certain resignation, coping (adaptation) and acceptance of the current situation. Therefore, the furniture should be easily movable and multi-functional, with an easy possibility for adaptation in space. This mostly refers to storage furniture which is oversized and heavy.
4. Proper use of ecologically and healthy materials when designing furniture and interiors in kindergartens. Greater application of wood and natural materials should be accepted as a standard.
5. For safety reasons, bunk beds should not be used in kindergartens. Children from one to six years old are too young to use these kinds of beds.
6. The existing regulations are too general and, in some places, vague and ambiguous. This can lead to confusion for the manufacturers, investors, kindergarten employees, and others involved in the process of purchasing and using furniture. With comprehensive analysis and involvement of interdisciplinary teams of experts, the rules and standards that should be binding in the process of furniture design should be improved.
7. The procurement of the furniture for the needs of the preschool institutions is done in a procedure established through public procurement. Despite criteria of economically

most favourable offer the main criterion for the procurement is the quality including the lowest price, and not the quality of the furniture. In this case, the best choice of the supplier is limited.

- 8.** During the procedure of public procurement of furniture for preschool institutions, the tender documentation should be well and precisely processed, in order to avoid various interpretations and misleadings, doubts and mistakes in the future. This means that the documentation should contain an accurate specifications and technical description of the products in the tender procedure and clear indications regarding the precisely defined dimensions, appearance, shape, characteristics, use of materials, etc.
- 9.** In the regulation that determine the equiping of preschool institutions, more precisely the types of furniture are flexibly described in the terms of design. In kindergarten facilities there is a need for differently designed furniture, for example, the chair, in addition to the main purpose of sitting, to be a toy or didactic tool. Therefore, the rulebooks should provide set of instructions that do not explain the type of furniture so rigidly, to allow the possibility of procurement and furniture that will change its appearance, and not as before, a chair can be a chair only and nothing more. The biggest disadvantage of furniture in the space is the inability to change its purpose and combine it into various forms.
- 10.** The furniture used in the kindergartens is not produced (designed) by a multidisciplinary team of experts. The process of designing this type of furniture should be controlled from the very beginning to the very end, until its production.
- 11.** The official body that conducts the public announcement for procurement and equipping of furniture in kindergartens must have professional staff in the field of architecture, construction and design of furniture and quality of furniture, or they must be consulted or otherwise involved.
- 12.** It is necessary to prepare regulations (guides or rulebooks) for equipping the preschool space in which the characteristics of the furniture (the required height sizes, appearance, construction, materials, quality) will be defined in detail. In the Republic of Croatia at the University of Zagreb Faculty of Forestry and Wood Technology the manual for for equipping educational and training institutions (Domljan et al., 2015) where all the parameters of what the furniture should look like and be designed are comprehensively processed is published.

13. Needs for designing furniture and the whole atmosphere in playrooms that will provide complete freedom to children, encouraging creativity and easier learning. Gradual abandonment of classic and impractical interiors with a central place on tables and chairs. Creating a space in which children with the help of multifunctional furniture will be able to play through which they more easily master the process of growth and development.

Proper organization of space and the use of appropriate equipment adapted to their age is also an important factor for the proper growth and development of children. Analysing the psychophysical activities of children as well as the functions they perform, a space must be designed and arranged that will correspond to their proper growth and development.

In the playroom there should be parts that will be partially divided, because children of this age want to play in smaller spaces, and when they feel the need to be left alone, due to excessive interaction, they can take refuge in one of these divided parts. The playrooms that are part of the facilities of this research are not organized to that concept. They are of the open type, which negatively affects the mental development of the child. Therefore, the partial division model should be used. It is necessary to divide the parts around the corners of the room, i.e. in those playrooms that are spacious to make such corners along the entire length of the playroom. The partitions can be made of furniture elements or toys that are in the playroom.

The sleeping function would be most effective if it was separated in a separate room, where each child would know his/her crib, so that he/she could lie down whenever he/she wanted.

The solution to all the problems listed above is complex and systemic and requires involvement of several competent institutions and teams of people from various professions.

This thesis confirms the necessity of intensive interdisciplinary cooperation of different professions on this issue in future research and design of furniture in buildings for preschool education, where the main users are: children - fragile beings who, by appropriate approach to their healthy growth and development, create the foundations of a healthy community and society as a whole.

8. BIBLIOGRAPHY

1. Abramson, L.S.; Turner-Henson, A.; Anderson, L.; Hemstreet P.M.; Bartholomew, L.K.; Joseph, L.M., C.; Tang, S.; Tyrrell, S.; Clark, M.N.; Ownby, D., 2006: Allergens in shool settings: Results of environmental assessments in 3 city school systems. *Journal of school health*, Vol. 76, No. 6: 246-249.
2. Altman, I.; Stokols, D., 1987: *Handbook of environmental psychology*. 2nd part. New York , Wiley-Interscience Publication.
3. Andersson, G.B.J., 1986: Loads on the Spine during Sitting. u: Corlett, N., Wilson, J., Manenica, I. (ed.), *The Ergonomics of Working Postures. Models, Methods and Cases. The proceedings of the First International Occupational Ergonomics Symposium Zadar, Yugoslavia, 15-17 April 1985*, Taylor & Francis, London, 309-318.
4. Anderson, G.B.J.; Ortengren, R.; Nachemson, A.; Elfstrom, G., 1974: Lumbar disc pressure and myoelectric back muscle activity during sitting. *Scandinavian Journal of Rehabilitation Medicine*, 3: 104–14.
5. Anderson, S. E.; Whitaker, R. C., 2009: Prevalence of obesity among US preschool children in different racial and ethnic groups. *Arsh pediatar asoles med/vol. 163 (no. 4)*.
6. Aries, F. 1989: *Centuries of childhood (Ариес, Ф. Векови Детинства)*. Београд, Завод за удѣбенике и наставна средства. (in macedonian)
7. Auf-Franić, H.; Bertina, M.; Oluić, V.; Rot-Čerina, M., 2008: *Kindergartens' architecture in Zagreb 1990- (2008Arhitektura dječjih vrtića u Zagrebu 1990-2008)*. Društvo arhitekata Zagreba. Arhitektonski fakultet, Zagreb. (in Croatian)
8. Auf-Franić H.; Oluić V.; Žarnić T.; Bertina M.; Korlaet L., Rister V., Roth-Čerina M., 2003: *Nurseries and kindergarten:Instructions for programming, planning and design (Dječje jaslice i vrtići: upute za programiranje, planiranje i projektiranje)*. Zagreb, Sveučilište u Zagrebu Arhitektonski fakultet, Biblioteka Acta Architectonica. (in Croatian)
9. Bajbutović, Z., 1983: *School building architecture (Arhitektura školske zgrade)*. Prvo izdanje. Sarajevo, Svjetlost, OOUR Zavod za udžbenike I nastavna sredstva. (in Bosnian)
10. Belamarić, D., 1987: *Child and space (Dijete i oblik)*. Zagreb: Školska knjiga. (in Croatian)
11. Bognar, L., Matijević, M., 1993: *Didactics (Didaktika)*. Zagreb, Školska knjiga. (in Croatian)
12. Bralić, I., 2008: *Secular changes in growth and development (Sekularne promjene rasta i razvoja)*. *Pediatr. Croatica* 52 (1): 25-35. (in Croatian)
13. Bridger, R.S., 2003: *Introduction of Ergonomics*. Routledge: 2nd edition London and New York, Taylor & Francis Group.
14. Burić, H., 2006: *Space from a kindergarten perspective (Prostor iz perspektive vrtića)*. *Dijete Vrtić Obitelj*. Broj 44: 18-20. (in Croatian)
15. Burić, H., 2006a: *Common dimensions: European influences in setting standards (Zajedničke dimenzije: europski utjecaji pri određivanju standarde)*. *Dijete Vrtić Obitelj*. Broj 44: 2-8. (in Croatian)
16. Burton, A.K., 2005: *How to prevent low back pain*. *Best Practice & Research Clinical Rheumatology* 19 (4): 541-555.
17. Buzina, R.; Grgić, Z.; Kovačević, M.; Maver, H.; Momirović, K.; Rudan, P.; Schmutzer, Lj.; Čtampar-Plasaj, B., 1975: *Antropometrija. Praktikum biološke antropologije (Antropometrija. Praktikum biološke antropologije)*. 1 Antropologijska binlioteka. Zagreb
18. Bylon, M., 1962: *School building (Školske zgrade)*. Beograd, Građevinska knjiga. (in Serbian)
19. Carlgren, F., 1990: *Education towards freedom. Rudilf Steiner's pedagogy Pictures andreports from the international movement of Waldorf schools (Odgoj ka slobodi. Pedagogija Rudolfa Steinera. Slike i izvješća iz međunarodnog pokreta waldorfskih škola)*: Prekop, I. (ed.). Zagreb, Društvo za waldorfsku pedagogiju. (in Croatian)
20. Ceppi, G.; Zini, M., 2001: *Children, space, relations – Metraproject for Enviormmnet for young children, Reggio children*. Milano, Domus Academy researches center.
21. Ching, Francis, D., K., 1987: *Interior design – Illustrated*. New York, Van Nostrand Reinhold Company.
22. Cohen, D.; Stern, V., 1974: *Observing and recording the behavior of young children*. NY, Teachers College Press.

23. Colbert, J. 2006: Classroom design and how it influences behavior. <http://www.communityplaythings.com/resources/articles/2006/classroom-design-and-how-it-influences-behavior> (Accessed Jan. 30, 2020)
24. Delpuch, F.; Traissac, P.; Martin-Prével, Y.; Massamba, Maire, B., 1999: Economics crisis and malnutrition: socioeconomic determinants of anthropometric status of preschool children and their mother in an African urban area. *Public nutrition health nutrition*, 3(1): 39 – 47.
25. Delchev, S., (Делчев, С) 1993: Fundamentals of industrial design and architecture (Основи на промишления дизайн в архитектурата). Техника, София. (in Bulgarian)
26. Dier, N.B., 2003: Evaluation of Fitness Between School Furniture and Children Body Size in Two Primary Schools in Haiphong, Vietnam. Master's Thesis, Luela University of Technology Department of Human Science Division of Industrial Ergonomics, 1-66.
27. Dijanošić, I. 2019: Design of wood products in therapy of sensory integrations of children (Oblikovanje drvenih proizvoda u terapiji senzorne integracije djece). Diplomski rad. Sveučilište u Zagrebu, Šumarski fakultet, Zagreb. (in Croatian)
28. Dimitrova, G., N., (Димитрова, Г., Н.), 2001: Biomechanical aspects of physical education in pre-school age (Биомеханички аспекти на физическото възпитание в предучилищната възраст). Дисертационен труд, Национална спортна академия, Анатомия и биомеханика и спортна медицина. София. (in Bulgarian)
29. Dobrevska, D.D. (Добревска, Д.Д.), 2012: The role and importance of the means of play in the educational world of the child from 1-5 years (Роля и значение на средствата за игра в предметния и образован свят на детето от 1-5 години), дисертация. Национална и художна академия, София. (in Bulgarian)
30. Domljan, D.; Grbac, I., 2003: Ergonomic principles relating to the design of school furniture, International conference Furniture industry adjustment to European standards, University of Zagreb, Faculty of Forestry, UFI-Paris, Zagreb: 27-38.
31. Domljan, D., 2011: The Design of Contemporary School Furniture as a Prerequisite for Maintainance of Pupils' Health (Oblikovanje školskog namještaja kao preduvjet očuvanja zdravlja učenika). Doktorski rad. Sveučilište u Zagrebu Šumarski fakultet, 1-390. (in Croatian)
32. Domljan, D.; Vlaović, Z., 2011: Technical documentation for equipping kindergarten (Техничка документација за опремање дječјих вртица) Projekt: Uvođenje standardizirane opreme i namještaja u sustav predškolskog odgoja i naobrazbe. Gradski ured za obrazovanje i šport Grada Zagreba, Sveučilište u Zagrebu Šumarski fakultet, Zagreb: 1-40. (in Croatian)
33. Domljan, D.; Grbac, I.; Rajković, V.; Vlaović, Z.; Živković, V.; Župčić, I., 2015: Equipping building for upbringing and education (Kvaliteta i tehnički opisi proizvoda od drva. Opereanje zgrada za odgoj i obrazovanje, sveučilišni priručnik). Svezak I. Sveučilište u Zagrebu Šumarski fakultet, Hrvatska gospodarska komora, Zagreb, 1-300. (in Croatian)
34. Dorfler, G., 1994: Introduction to design, language and history of serial production (Uvod u dizajn, jezik i istorija serijske proizvodnje) Novi Sad, Svetovi. (in Serbian)
35. Dostoglu Turkun, N.; Şahin, E. B., 2012: The importance of preschoolers' experience in kindergarten design. *METU Journal of the Faculty of Architecture, Middle East Technical University, Faculty of Architecture, Turkey*, (29:1): 301-320.
36. Dragostinova-Dobрева, I., 2019: Sustainable application of wood in children's design. *Innovation in woodworking industry and engineering design. New Bulgarian University, Sofia, Bulgaria*, 2/2019 (16): 49 – 58.
37. Dragostinova-Dobрева, D., I., (Драгостинова- Добрева, Д., И.), 2013: About the mission of design for the children's environment (За мисията на дизайна за детската среда). В: Сборник научни доклади, София, НБУ: 25-29. (in Bulgarian)
38. Dragostinova-Dobрева, D., I., (Драгостинова- Добрева, Д., И.) 2008: Design for the interior of prophylactic and medical facilities for children (Дизайн за интериора на профилактичните и лечебните заведения за деца). Дисертационен труд. Национална художествена академия, Факултет за приложени изкуства. София. (in Bulgarian)
39. Dudek, M., 2000: Kindergarten architecture: Space for Imagination. Second edition. New York, Spon Press, Taylor & Francis Group.
40. Dudek, M., 2005: Children's spaces. Oxford, Architectural Press, An imprint of Elsevier.
41. Dudek, M., 2008: A Design Manual, School and Kindergarten. Berlin, Birkhäuser Verlag AG.
42. Dundova, R., (Дундова, Р.,) 1978: Върху някои социални и биологични (On some social and biological growth factors) фактори на растежа. *Педиатрия*, 4. 341 – 348.
43. Dzambo, M., 2013: Comenius, katalog izložbe, Adalbert Stifter Verein, Munchen.
44. Eckelman, C.A.; Haviarova, E.; Zhu, H.; Gibson, H., 2001: Considerations in the Design and Development of School Furniture Based on Local Resources. *Forest Products Journal* 51, (6): 56-63.

45. Eiben, O., G., 1988: Growth survey. *Coll. Antropol. Zagreb*, 12 (1988) 1: 95 -107.
46. Evans, O.; Collins, B.; Steward, A., 1992: Is school furniture responsible for student sitting discomfort? *Proceedings of the 28th Annual Conference of the Ergonomics Society of Australia on Unlocking Potential for the Future Productivity and Quality of Life*. Melbourne: Ergonomics Society of Australia, 31-37.
47. Falk, B., 2019: Provisioning the environment: Supporting high Quality early learning. <http://www.communityplaythings.com/resources/articles/2019/high-quality-early-learning-environments> (Accessed March 15, 2020)
48. Fiechtner, J. and Albrecht, K., 2015: Supporting Emotional and Social Development. *Connections between the Classroom Environment and Thriving Children*. <http://www.communityplaythings.com/resources/articles/2015/social-emotional-development> (Accessed March 20, 2020)
49. Philipps, S., 2003: Montessori priprema za život, odgoj neovisnosti I odgovornosti (Montessori prepares for life, education of independence and responsibility). 2 izdanje. Jastrebarsko, Naklada Slap. (croatian)
50. Fischil, J., 2011: Five ways to make your classroom homey. <http://www.communityplaythings.com/resources/articles/2011/five-ways-to-make-your-classroom-homey> (Accessed March 15, 2020)
51. Genchov, P., D., (Генчов, П., Д.,) 1967: Child psychology (Детска психология). Четвърто преработено издание. София, Наука и изкуство. (in Bulgarian)
52. Gjorgoski, I.; Dashtevski, B., 2004: Fundamentals of Anthropology. University "St. Cyril and Methodius" - Skopje, Faculty of Natural Sciences and Mathematics. Skopje. (in Macedonia)
53. Gegov, G., (Гигов, Г.,) 2007: Design for the child – provocation and responsibility of a non-standard idea (Дизайн за детето – провокация и отговорност на нестандартна идея. Проблеми и перспективи и развитието на съвременните промишлени изкуства, Сборник доклади. Издателска къща ЛИК. (in Bulgarian)
54. Goonetilleke, R.S.; Feizhou, S., 2001: A methodology to determine the optimum seat depth. *International Journal of Industrial Ergonomics* 27 (4): 207-217.
55. Grbac, I (2003): Healthy living – healthy housing (Zdrav život – zdravo stanovanje). *Spektar media Zagreb, odabrana poglavlja*. (in Croatian)
56. Grbac I.; Ivelić Z., 2005: Upholstered furniture (Ojastučeni namještaj), Sveučilište u Zagrebu, Šumarski fakultet, Zagreb. (in Croatian)
57. Grbac, I., 2006: Bed and health (Krevet i zdravlje). Sveučilište u Zagrebu, Šumarski fakultet, Zagreb. (croatian)
58. Grbac, I.; Ivelic, Ž.; Tkalec, S., 2000: Design of children's cots with regard to child anthropometry, 6th international design conference - Design 2000, Cavtat-Dubrovnik: 221-226.
59. Grozev, O.; Tiholov, K., (Грозев, О., Тихолов, К.,) 1993: Interior: Design guide (Интериор: Ръководство за проектиране). София, Техника. (in Bulgarian)
60. Gruevski, T.; Simakoski, N., 2003: Design of furniture, University "Ss Kiril and Metodius, Faculty of forestry, Skopje. (in Macedonian)
61. Gruevski, T.; Simakoski, N., 2003: Elements of wood constructions, University "Ss Kiril and Metodius, Faculty of forestry, Skopje. (in Macedonian)
62. Hänninen, O.; Koskelo, R., 2003: Adjustable tables and chairs correct posture and lower muscle tension and pain in high school students. In: *Proceedings of the XVth Triennial Congress of the International Ergonomics Association*. IEA, Seoul, Korea.
63. Haviarova, E.; Eckelman, C.; Erdil, Y., 2001: Design and Testing of Environmentally Friendly Wood School Chairs for Developing Countries. *Forest Products Journal* 51 (3): 56-64.
64. Hedge, A., 2015: Survival of *Escherichia coli*, *Pseudomonas aeruginosa*, *Staphylococcus aureus* on Wood and Plastic Surfaces. *Microbial -Biochemical technology*, Vol. 7(4): 209-211
65. Hernandez, M., E., 2010: Open windows: Prime times for early Learning. <https://www.communityplaythings.com/resources/articles/2010/Open-Windows-Prime-Times-for-Early-Learning> (Accessed March 16, 2020)
66. Herrington, S., 2003. Kindergarten: Garden pedagogy from romanticism to reform. *Landscape J.*, 20(1): 30-47
67. Hira, D.S., (1980) An ergonomic appraisal of educational desks, *Ergonomics*, 23: 213-21.
68. Iliev, B., 2011: Comparative analysis for the pre school institutions in Municipality of Centar with modern tendencies in designing and articulations of specific interventions in space as a result of the psycho-physical needs by the children, magistarski rad. University Ss Kiril and Metodius, Faculty of Design and Technology of furniture and interior, Skopje (in Macedonian).

69. Iliev, B.; Karanakov, V., 2013: The anomalously designed children furniture as a reason for curvature. International journal of wood science, design and tecnolog - International indexed journal, Skopje, Volume I No. 1: 6-11.
70. Iliev, B.; Domljan, D., 2016: Anthropometric analysis as an important method for designing suitable furniture for preschool children. Proceedings of 27th International Conference on Wood Science and technology (ICWST) University of Zagreb, Faculty of Forestry – Zagreb: 83-88.
71. Iliev, B.; Domljan, D., 2017: Comparison between preschool tables used in kindergartens in Croatia, Macedonia and Bulgaria. Proceedings of 28th International Conference on Wood Science and technology (ICWST) University of Zagreb, Faculty of Forestry – Zagreb: 207-214.
72. Iliev, B.; Domljan, D.; Vlaović, Z., 2018: Importance of anthropometric data in design of preschool furniture. Book of Proceedings of the 7th International Ergonomics Conference Ergonomics – Zadar: 141-148.
73. Ivanova, M., E., (Иванова М. Е) 2015: The interior of school bildngs (Интериорът на училишните сгради), Дисертационен труд. Университет по архитектура, строителство и геодезия. Архитектурен факултет, София. (in Bulgarian)
74. Ivanova, N., (Иванова, Н.,) 1984: History of design (История на дизайна). Наука и изкуство, София. (in Bulgarian)
75. Ivanović Šekularac, J., 2000: Preschool edifition and comford (Predškolske ustanove i komfor). Beograd, Zadužbina Andrejevi. (in Serbian)
76. Jaeger, U., 1998: Secilar trends in Germany. In: Bodzsar, E. and Susanne, C. (eds): Secular growth changes in Europe. Eötvös Univ. Press, Budapest, pp 135-160.
77. Jones, G.T.; Macfarlane G.J., 2005: Epidemiology of low back pain in children and adolescents, Archives of Disease in Childhood, Vol. 90: 312-316.
78. Kahr, B., 2004: Crystal Engineering in Kindergarten. Crystal growth & design. Vol. 4, No. 1: 3-9.
79. Kamenov, E., (Каменов, Е.,) 1988: Preschool pedagogy (Предучилишна педагогија). Книга прва. Скопје, Просветно дело. (in Macedonian)
80. Kamenov, E. 1999: Preschool pedagogy (Predškolska pedagogija). Knjiga prva. Beograd, Zavod za udžbenike i nastavna sredstava. (in Serbian)
81. Kuchukov, G., (Кючуков, Г.,) 2004: Consrtuction of furniture, doors and windows (Конструиране на мебели, врати и прозорци). София, Матком. (in Bulgarian)
82. Kirova, M. D. (Кирова, М. Д.), 2006: Psychophysiological impact of color in the interior of kindergarten (Психофизиологично въздействие на цвета в интериора на детска градина). Дисертация. Технически Университет, Машини елементи при МТФ, Варна. (in Buldarian).
83. Klaren, U.; Arnkil, H.; Fridel Anter, K., 2003: Colour and Light in Design - Levels of experiencing colour and light. Design learning for tomorrow. Volume 2. Design Education from kindergarten to PhD. Proceeding from the 2nd International conference for Design education researches, 14-17 May 2013, Oslo, Norway: 743-752
84. Klein, S. A., 2014: The power of purposeful preschool environments. <http://www.communityplaythings.com/resources/articles/2014/the-power-of-purposeful-environments> (Accessed March 16, 2020)
85. Knight, G.; Noyes, J., 1999: Children’s Behaviour and the design of school furniture. Ergonomics, Vol 42, No. 5: 747 – 760.
86. Krauth, V., 1993: Waldorfska pedagogija – briga za odrastanjem I odgoj k slobodi (Waldorf pedagogy – care for growing up and education for freedom. Zagreb, Metodički ogledi, 3(2): 75-87. (croatian)
87. Kroemer, K. H. E.; Kroemer, H. B.; Kroemer-Elbert, K. E., 2003: Ergonomics: how to design for ease and efficiency. second ed. New Jersey, Prentice Hall, Inc.
88. Lapaine, B., 1994: Design (Dizajn). Zagreb, Šumarski fakultet, Sveučilište u Zagrebu. (in Croatian)
89. Legg, S. J.; Pajo, K.; Marfell-Jones, M.; Sullman, M., 2003: Mismatch between classroom furniture dimensions and student anthropometric characteristic in three New Zealand secondary schools. In: Proceedings of the 15th Congress ofthe International Ergonomics Association, Ergonomics for Children in Educational Environments Symposium, vol. 6, 24–29 August 2003, Seoul, Korea, 395–397.
90. Liempd van, I., 2006: Use of space: theory and practice (Korištenje prostora: teorija i praksa). Dijete Vrtič Obitelj, Broj 44: 23-26. (in Croatian)
91. Luce-Smith, E., 2005: Furniture a concise history. London, Thames & Hudson Ltd.
92. Lazarov, V., V., (Лазаров В., В.,) 1975: Public building (Обществени сгради). Книга първа. София, Държавно издателство „Техника“. (in Bulgarian)
93. Lueder, R.; Berg R., V., J., 2008: Ergonomics for children. Designing products and places for toddlers to teens. New York, Taylor & Francis.
94. Mandal, A. C., 1982: The correct height of school furniture. Hum. Factors 24: 257–269.

95. Mandal, A. C., 1986: Investigation of the Lumbal Flexion of Office Workers. u: Corlett, N., Wilson, J., Manenica, I. (ed.), *The Ergonomics of Working Postures. Models, Methods and Cases. The proceedings of the First International Occupational Ergonomics Symposium Zadar, Yugoslavia, 15-17 April 1985*, Taylor & Francis, London, 345-354.
96. Mandal, A. C., 1994: The prevention of back pain in school children. u: Lueder, R., Noro, K. (ed.), *Hard Facts about Soft Machines: The Ergonomics of Seating*. Taylor & Francis, London, 269-277.
97. Marković, M.; Šain, M.; Kovačević, I.; Koruga, D.; Ivanović, R.; Beljanski-Ristić, Lj.; Krsmanović, M.; Gajić, Z.; Petković, D. 1997. Step by step 2 (Korak po korak 2). Beograd, Grafiprof (in Serbian).
98. Maver, H.; Muftić, O.; Rudan, P.; Tarbuk, D., 1976: Ergonomic methods. Practicum of biological anthropometry (Ergonomske metode. Praktikum biološke antropologije). Kolo 3. Svezak 2. Zagreb, Antropologijska biblioteka. (in Croatian)
99. Mikšić, D., 1997: Introduction to ergonomics (Uvod u ergonomiju). Zagreb, Sveučilište u Zagrebi, Fakultet strojarstva i brodogradnja. (in Croatian)
100. Mijović, B., 2008: Applied ergonomics (Primijenjena ergonomija). Karlovac, Veleučilište u Karlovcu. (in Croatian)
101. Molenbroek, J.-F.M.; Kroon-Ramaekers, Y.M.T.; Snijders, C.J., 2003: Revision of the design of a standard for the dimensions of school furniture. *Ergonomics* 46 (7): 681- 694.
102. Montessori, M., 1969: *The Montessori Method*. New York, Schocken Books.
103. Montessori, M., 2003: *Child – the secret of childhood (Dijete – tajna djetinjstva)*. Jastrebarsko, Naklada Slap. (in Croatian)
104. Mow, E., 2006: Happy space. <https://www.communityplaythings.com/resources/articles/2006/Happy-Spaces> (Accessed March 15, 2020)
105. Muftić, O.; Veljović, F.; Jurčević-Lulić, T.; Miličić, D., 2001: Basics of ergonomics (Osnovi ergonomije). Sarajevo, BiH, Univerzitet u Sarajevu, Mašinski fakultet – Sarajevo. (in Bosnian)
106. Muftić, O., 2005: Biomechanical ergonomics (Biomehanička ergonomija). Zagreb, Sveučilište u Zagrebu, Fakultet strojarstva i brodogradnje. (in Croatian)
107. Nacheva, A.; Zhecheva, J. V.; Dzecheva, J.; Jankova, I.; Filcheva Z.; Mitova, Z.; Jordanov, J., 2012: Physical development of children and adolescents in Bulgaria on the border between 20th and 21th century (Физическо развитие на деца и подрастваши в България на границата между XX и XXI век. София, БАН, Институт по експериментална морфология антропология с мезей. Академично издателство „ проф. Марин Дринов“). (in Bulgarian)
108. Neufert, E., 2003: Architectural design (Arhitektonsko projektovanje). 37 prošireno i prerađeno izdanje. Beograd, građevinska knjiga. (in Serbian)
109. Neiza, P., 2017: Redesigning learning spaces: What do teachers want for future classroom? International Conference educational Technologies. ISBN: 978-989-8533-71-5
110. Nikolova, Y., (Николова, Ы.) 1986: Children’s institutions (Детски заведения). София, Изд. „Техника“. (in Bulgarian)
111. Nikoloska, M., (Николоска, М.) 2002: Developmental psychology – childhood (Развојна психологија – детство). Скопје, Народна и универзитетска библиотека „св. Климент Охридски“. (in Macedonian)
112. Norris, B.; Wilson, J. R., 1995: *Childata. The handbook of child measurements and capabilities - Data for design safety, Consumer safety unit. University of Nottingham, DTI, UK.*
113. Önder B.; Aydintan, E.; Elmali, D.; Midilli, R., 2006: Anthropometric evaluation of the Crèchers children furniture in Turkey. *Coll. Antropol.* 30 (2006) 4: 853-865.
114. Panagiotopoulou, G.; Christoulas, K.; Papanckolaou, A.; Mandroukas, K., 2004: Classroom furniture dimensions and anthropometric measures in primary school. *Applied Ergonomics* 35 (2): 121-128.
115. Panero, J.; Zelnik, M., 1990. Anthropological measures and interior, Collection of recommendation for design standards (Antropološke mere i enterijer, Zbirka preporuka za standarde u projektovanju). Beograd, IRO Građevinska knjiga. (in Serbian)
116. Paracels, C.; Stommel, M.; Hubbard, R.P., 1999: Mismatch of classroom furniture and student body dimensions. Empirical findings and health implications. *Journal of Adolescent Health* 24 (4): 265-273.
117. Pasalar, C., 2003: The effects of spatial layouts on students' interactions in middle schools: multiple case analysis. Doctoral dissertation, Faculty of North Carolina State University, USA.
118. Papanek, V., 1971: *Design for the real world, Human ecology and social change*. Sweden, Thames and Hudson.
119. Pheasant, S., 2003: *Body space, Anthropometry, Ergonomics and the Design of work*. Second edition. London, Taylor & Francis
120. Pisareva, E. (Писарева, Е.) 1999: Furnishing of the public bulding (Обзавеждане на обществени сгради). Sofia. University of Forestry, Sofia. (Лесотехнически факултет, София) (in Bulgarian).

121. Podđakov, N. N., 1992: Practical thinking in children (Praktično mišljenje kod dece). Drugo izdanje. Beograd, Zavod za udžbenike I nastavna sredstava. (in Serbian)
122. Pop – Jordanova, N.; Grigorova, E., 2015: Influence of climate changes on health. M.A.N.U. Contributions, Sec. of med. Sci. XXXVI 3.
123. Prebeg, Ž., 1997: Variations in growth patterns of schoolchildren in Croatia over the last decade. In: Growth and Development in the Changing World. Roberts, D.F., Rudan, P., Škarić-Jurić, T. (eds.), Anthropological library, Croatian Anthropology Society, Zagreb, Croatia, 111-130.
124. Prebeg, Ž.; Prebeg, Ž., 1985: Hygiene and school (Higijena i škola). Peto izdanje. Zagreb, Školska knjiga. (in Croatian)
125. Prebeg, Ž.; Jureša, V.; Kujundžić, M., 1995: Secular growth changes in Zagreb school children over four decades, 1951-92. Ann Hum Biol 22: 99-110.
126. Prebeg, Ž.; Slugan, N.; Reić, L.; Stipić, N.; Ferri-Matić, M.; Treber-Ćulumović, S.; Drinković, M., 1994: Secular growth changes in school children in Croatia. Coll Antropol 2: 309-316.
127. Premerl, T., 1973: Mišljeni prostor Rudolfa Steinera (The thought space of Rudolf Steiner). Arhitektura 26 (145): 49-52.
128. Quarante, D., 1990: Basics of industrial design (Osnove industriskog dizajna). Zagreb, Arhitektonski fakultet, Sveučilište u Zagrebu, Interfakultetski studij dizajna. (in Croatian)
129. Raychev, R., (Райчев, Р.,) 2005: Цветовете в изкуството (Colors in art). София, Изд. Лук. (bulgarian)
130. Raycheva R. P., (Райчева, Р., П.,) 1998: Interior architecture (Вътрешна архитектура). София, ЛТУ. (in Bulgarian)
131. Ratković, M., 2015: Furniture for preschool children (Namještaj za djecu predškolskog uzrasta). Diplomski rad. Sveučilište u Zagrebu, Šumarski fakultet, Zagreb. (in Croatian)
132. Ray, G.G.; Ghosh, S.; Atreya, V., 1995: An anthropometric survey of Indian schoolchildren aged 3-5 year. Applied Ergonomics. Volume 26, Issue 1: 67-72
133. Remenschneider, C., 2017: Designin for imagination. Creating buildings to help young children learn. <http://www.communityplaythings.com/resources/articles/2017/designing-for-imagination> (Accessed March 20, 2020)
134. Ridolfi, M., 1975 : Manuale dell' architetto. Roma, Consiglio Nazionale delle Ricerche.
135. Rot-Čerina, M., 2015: Defining architectural parameters in designing buildings for preschool education (Određivanje arhitektonskih parametara u projektiranju zgrada za predškolski odgoj), doktorski rad. Sveučilište u Zagrebu Arhitektonski fakultet, Zagreb. (in Croatian)
136. Salvendy, G., 1997: Handbook of human factors and ergonomics: 2nd edition. New York, John Wiley & Sons, INC.
137. Schröder, 1997: Sitting posture and physical activity. Zagreb. Coll. Antropol 21(1997)2, 397- 403.
138. Sandahl, D., I., 2019: Dame on danisg style (Igra na danski način). Zagreb, Egmond. (in Croatian)
139. Siu Michael, W. K.; Lam, S. M.; Wong, I. Y., 2015: Gender differences in children's use of colors in designing safety sign. 6th International Conference on Applied Human Factors and Ergonomics (AHFE 2015) and the Affiliated Conferences, AHFE 2015. Procedia manufacturing 3: 4650 – 4657.
140. Smoljanović, M., 1986: A contribution to the study of the Interaction between the psychophysical development of the child and the preschool room (Prilog istraživanju interakcije psihofizičkog razvoja djeteta i prostorije za boravak u predškolskim dječjim ustanovama) Doktorska disertacija. Univerzitet Sveučilišta u Zagrebu, Arhitektonski fakultet, Zagreb. (in Croatian)
141. Stanković, B. D., (Станковић, Б., Д.,) 2009: Psychological aspects and designing of preschool institutions for children – contemporary experience and development tendencies (Психолошки аспекти и пројектовање дечјих предшколских установа – савремена искуства и тенденције развоја). Докторска дисертација. Универзитет у Београду, Архитектонски факултет, Београд. (in Serbian)
142. Starmer, A., (Стармър, А.,) 2005: Colors, encyclopedia. How to match colors to achieve comfort in your home (Цветовете, енциклопедия. Как да съчетаваме цветовете, за да постигнем уют и комфорт в своя дом). София, Книгомания ЕООД. (in Bulgarian)
143. Dteiner, R., 2002: Anthroposophy, Anthroposophical Society (Antropozofija, Antropozofsko društvo). Zagreb, "Marija Sofija", AGM. (in Croatian)
144. Şahin, E. B.; Turkun Dostoglu, N., 2012: The importance of preschoolre' experience in kindergarten design. METU JFA 2012/1. Ankara, Turkey, (29:1) 301-320.
145. Stevanović, B., 1970: Pedagogical psychology (Pedagoška psihologija): Drugo izdanje. Ljubljana, Državna založba Slovenije. (in Slovenian)
146. Stevanović, M., 2001: Prescool pedagogy (Predškolska pedagogija): Druga kniga. Tuzla, R & S. (in Croatian)

147. Stoecklin, L. V., 2007: Designing quality child care facilities.
<http://www.communityplaythings.com/resources/articles/2007/designing-quality-child-care-facilities>
 (Accessed March 20, 2020)
148. Šercer, A., 1986: Medical encyclopedia (Medicinska enciklopedija). II izdanje, Zagreb, Leksikografski zavod Miroslav Krleža (in Croatian).
149. Sherilova, V., (Шерилова, В.,) 2009: A huge lexicon of foreign words and expressions (Голем лексикон на странски зборови и изрази). 1 том. Скопје, Топер. (in Macedonian)
150. Trevelyan, F.C., Legg, S.J., 2006: Back pain in school children – Where to from here? *Applied Ergonomics* 37 (1). 45-54.
151. Trojchanec, Z., (Тројчанец, З.) 1981: Anthropometrical, functional and motoric characteristic of the students from the University of “Cyril and Methodius” – Скопје (Антропометриски, функционални и моторички карактеристики на студентите од Универзитетот „Кирил и Методиј“ – Скопје). Универзитетот „Кирил и Методиј“, Медицински факултет, Институт за МЕП физиологија – Скопје. Хабилизационен труд. Скопје. (in Macedonian)
152. Troussier, B.; Tesniere, C.; Fauconnier, J.; Grisons J.; Juvin, R.; Phelip, X., 1999: Comarative study of two different kinds of school furniture among children, *Ergonomics*, Vol 42: No. 3, 516 – 526.
153. Trstenjak, A., 1987: Man and coulors (Čovek i boje). Beograd, Nolit. (in Serbian)
154. Tuttle, N. A., 2000: Seat position and contours for high school chairs. Master thesis, School of Physiotherapy and Exescise Science, Griffith University, Gold Coast.
155. Valkov, I., (Вълков, И.) 2001: The interior and exterior in preschool facilities (Интериорът и екстериорът на детските заведения). Фабер. В. Търново. (in Bulgarian)
156. Vasta, R.; Haith, M. M.; Miller, A. S., 2005: Children Psychology (Dječja psihologija). 3 izdanje. Zagreb, Naklada slap. (in Croatian).
157. Vassiliki, R.; Aimilia, R. (2012). Using the Mosaic technique – approaches in kindergartens: a Greek case study (Korištenje tehnike Mozaik – pristupa u dječjim vrtičima: grčka studija slučaja). *Dijete, vrtić, obitelj*, Zagreb. broj 69 jesen 2012: 1-3. (in Croatian)
158. Velkov, V., (Велков, В.,) 2005: Теория на художественото проектиране и анализ на детската среда (Theory of artistic design and analysis of the children’s environment). Дизайн и декоративни – проложни изкуства. Сборник научни доклади. Издателска къща ЛИК, София. (in Bulgarian)
159. Vlaović, Z.; Domljan, D.; Grbac, I., 2008: Wood and wood based materials in office and school furniture. International scientific conference Wood is good – properties, technology, valorisation, application, October 17th 2008, Innovawood, Faculty of Forestry Zagreb, UFI-Paris, Zagreb fair: 51-58.
160. Vodenova, M. P., (Воденова, М., П.,) 2017: Systematic approach to build a child environment in the contemporary home (Системен подход при изграждане на детска среда в съвременното жилище) дисертация, Лесотехнически унижерситет, София. (in Bulgarian).
161. Voigt, A., Greil, H., 2009: Body measurmens and the variability of sitting posture at preschool age as precondition for an optimal adjustment of chair anf tabel. *Anthropologisher Anzeiger*, Jahrg. 67, H 1March: 45-52.
162. Walsh Bruke, K., 2004: Primary school curriculum: Creating a child-centered classroom (Kurikulum za prvi razred osnovne škole: Stvaranje razreda usmjerenog na dijete). 2 izdanje. Zagreb, Pučko otvoreno učilište Korak po korak, Tiskara Zelina d.d. (in Croatian).
163. Watson, K.D., Papageorgiou, A.C., Jones, G.T., Taylor, S., Symmons, D.P.M., Silman, A.J., Macfarlane, G.J., 2003: Low back pain in schoolchildren: the role of mechanical and psychosocial factors. *Archives of Disease in Childhood* 88: 12-17.
164. Wardle, F., 2011: Creating indoor environment for young children.
<http://www.communityplaythings.com/resources/articles/2011/creating-indoor-environments-for-young-children>
 (Accessed March 15, 2020)
165. Wiser, M., 2011: Criteria for selecting play equipment. <http://www.communityplaythings.com/resources/articles/2011/criteria-for-selecting-play-equipment> (Accessed March 15, 2020)
166. Yalcin, M., 2013: Constructing design knowledge built up on the kindergarten education. Design learning for tomorrow. Volume 4. Design Education from kindergarten to PhD. Proceeding from the 2nd International conference for Design education researches, 14-17 May 2013, Oslo, Norway: 1856- 1866
167. Yarbrough, K. A., 2001: The Relationship of School Design to Academic Achievement of Elementary School Children, doctoral dissertation, The University of Georgia.
168. Zhecheva, J. V., (Жечева, Я., В.,) 2007: Anthropometric characteristics of growth and development of the children in Sofija in the age between 3 and 6 years. (Антропометрична характеристика на растежа и развитие на деца от София на възраст между 3 и 6 години в началото на века), дисертация, Българска Академия по науките, София. (in Bulgarian).

169. Zini, M., 2006: (See, listen, touch, taste, smell and love Vidi, osluhni, dodirni, okusi pomiriši i voli). *Dijete Vrtič Obitelj*. Broj 44: 15-18. (in Croatian)
170. Živičnjak, M., Smolej Narančić, N., Szivovicsa, L., Franke, D., Hrenović, J., Bišof, V., 2003: Gender-Specific Growth Patterns for Stature, Sitting Height and Limbs Length in Croatian Children and Youth (3 to 18 Years of Age). *Coll. Antropol* 27 (1): 321–334.
171. Žlebni L., 1955: *Opća povijest pedagogije*. Zagreb. Pedagoško-književni zbor.
- 172.***, 1965a: JUS.D.E4. 021. Yugoslav standard. Tables for children of preschool age.
- 173.***, 1965b: JUS.D.E4. 022. Yugoslav standard. Chairs for children of preschool age.
- 174.***, 1988a: (BDS) БДС 8475 – 88. Български стандарт. Функционални димензии на мебелите за деца од предучилишна възраст. Класификация и функционални размери, К25, С. Официално издание на Комитета по качество към министерски съвет.
- 175.***, 1988b: (BDS) БДС 8878-88. Мебели за деца и юноши от училишната възраст Класификация и функционални размери, К24, С. Официално издание на Комитета по качество към министерски съвет.
- 176.***, 2001: United State Patent, 2001: Task chair with adjustable seat depth. Patent No.: US 6,189,971 B1. Inventor: Uli Witzig, W.
- 177.***, 2008c: Državni pedagoški standard predškolskog odgoja i naobrazbe. (Narodne novine br.:63/08, Hrvatski sabor, Zagreb.
- 178.***, 2009a: Министерство за труд и социјална политика. Ран детски развој, Стандарди за рано учење и развој кај деца од 0 до 6 години. Скопје: Национална и универзитетска библиотека „Св. Климент Охридски.
- 179.***, 2009b: Правилник за стандарди и нормативите за вршење на дејноста на детска градинка. Министерство за труд и социјална политика на република Македонија. (Службен весник на Република Македонија 35/2009).
- 180.***, 2010: Državni pedagoški standard predškolskog odgoja I naobrazbe, *Narodne novine*“ broj 90. od 21.07.2010
- 181.***, 2011: Цветопсихология и интериор. Езика на цветовете в интериорните решения на XXI век. (Color Psychology and interior. The language of colors in the interior decisions of the 21 st century) Книгомания, София.
- 182.***, 2013: Law on the Protection of Children. Ministry of Labor and Social Policy of the Republic of Macedonia (Official Gazette of the Republic of Macedonia 23/2013).
- 183.***, 2015a: EN 747- 1:2012+A1:2015, Bunk beds and high beds – Part 1: Safety, strength and durability requirements
- 184.***, 2015b: EN 1729 -1: 2015 Chairs and tables for educational institutions - Part 1: Functional dimensions.
- 185.***, 2016a: Ordinance № 5 of 03.06.2016 on pre-school education Prom. - SG, no. 46 of 17.06.2016, in force since 01.08.2016. Issued by the Minister of Education and Science. Наредба № 5 от 03.06.2016 г. за предучилишното образование Обн. - ДВ, бр. 46 от 17.06.2016 г., в сила от 01.08.2016 г. Издадена от министъра на образованието и науката.
- 186.***, 2016b: Ordinance № 12 of 01.09.2016 on the status and professional development of teachers, principals and other pedagogical specialists Prom. - SG, no. 75 of 27.09.2016, in force since 27.09.2016. Issued by the Minister of Education and Science. Наредба № 12 от 01.09.2016 г. за статута и професионалното развитие на учителите, директорите и другите педагогически специалисти Обн. - ДВ, бр. 75 от 27.09.2016 г., в сила от 27.09.2016 г. Издадена от министъра на образованието и науката.
- 187.***, 2016c: Rulebook on Standards and Norms for Performing the Activity of Institutions for Children" - "Official Gazette of the Republic of Macedonia" no. 170 from September 7,
- 188.***, 2018a: Law on Protection of Children, “Official Gazette of the Republic of Macedonia (Законот за заштита на деца, „Службен весник на Република Македонија,„) no, 21/18
- 189.***, 2018b: Institutions for care and upbringing of children - kindergartens - centers for early childhood development, 2017, Central Bureau of Statistics of the Republic of Macedonia, Skopje, May 2018
- 190.***, 2019a: Education in Republic of Bulgaria 2019 - kindergartens (preschool education), 2019, National Statistical Institute of the Republic of Bulgaria, Sofia, April 2019.
- 191.***, 2019b: Education, science, culture and social welfare - Kindergartens and other legal entities providing preschool education programs. Beginning of 2018/2019 Central Bureau of Statistics, Republic of Croatia.
- 192.web 1: <https://www.pinterest.com/pin/337488565801468228>
- 193.web 2: <https://www.vs.de/montessori/en/>
- 194.web 3 <https://www.vs.de/montessori/en/detail/213>

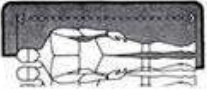
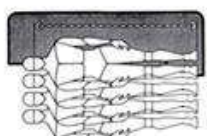
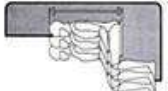
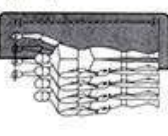
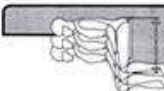
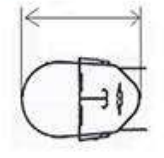
- 195.web 4: <https://www.reggiochildren.it>
- 196.web 5: <https://www.communityplaythings.com/inspiration/sample-classrooms/toddler-room-b-2019>
- 197.web 6: <https://www.communityplaythings.com/inspiration/sample-classrooms/montessori-early-childhood>
198. web 7: Education and culture Bg, 1: Lifelong learning program A. Модул 3: Антропометрия, Сесия 1: Въведение в детската антропометрия.
http://www.bgtextiles.org/files/custom/flies%202013/Modul/MODULE3_SESSION_1_BG.pdf
- 199.web 8: Education and culture Bg, 2: Lifelong learning program B. Модул 3: Антропометрия, Сесия 2: Антропометрични размери и база данни
http://www.bgtextiles.org/files/custom/flies%202013/Modul/MODULE3_SESSION_2_BG.pdf
- 200.web 9: <http://www.communityplaythings.com/products>
- 201.web 10, <http://www.communityplaythings.com/products/chairs/j710-10-woodcrest-chair>
- 202.web 11: <http://www.communityplaythings.com/products/chairs/j807-6-mealtime-chair-with-tray>
- 203.web 12: <http://www.communityplaythings.com/products/chairs/j807-6-mealtime-chair-with-tray>
- 204.web: 13: <http://www.communityplaythings.com/resources/articles/2017/designing-for-imagination>
- 205.web 14: <http://www.communityplaythings.com/resources/articles/2014/the-power-of-purposeful-environments>
- 206.web 15: <https://archa-chantal.cz/galerie/>

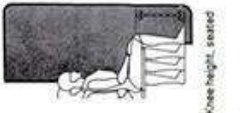
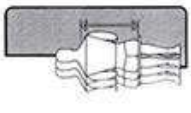
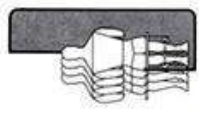
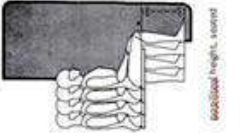
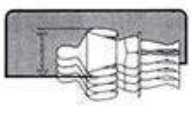
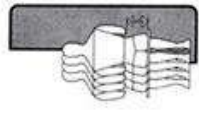
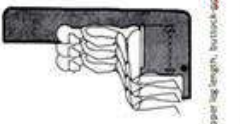
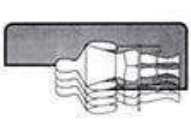
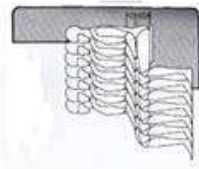
APPENDIX

APPENDIX I. FORM FOR ANTHROPOMETRIC DIMENSIONS OF THE RESPONDENTS - CHILDREN

(In each polygon the template was prepared in the official language of the state)

Date: _____
 Name of preschool institution: _____
 Gender of the child being measured: M. F.
 Child: _____

 <p>Stature</p>	 <p>Height to the eye</p>
 <p>Sitting height</p>	 <p>Maximum reach</p>
 <p>Upper leg length, buttock to knee, seated</p>	 <p>Head height</p>

 <p>Knee height, seated</p>	 <p>Shoulder height, seated</p>	 <p>Hip breadth</p>
 <p>Elbow height, seated</p>	 <p>Shoulder width</p>	 <p>Elbow height, seated</p>
 <p>Upper leg length, buttock to knee, seated</p>	 <p>Width from elbow to elbow</p>	 <p>Lumbar height</p>

APPENDIX II. SURVEY FOR RESPONDENTS - EMPLOYEES IN KINDERGARTENS

(In each polygon, the survey was conducted in the official language of the country)



UNIVERSITY OF ZAGREB - FACULTY OF FORESTRY
Children's furniture and wooden products in kindergartens
QUESTIONNAIRE



To Whom It May Concern,

As part of our PhD research at the Faculty of Forestry, University of Zagreb, we are conducting a survey to get your opinion on furniture and equipment you regularly use when working with children in kindergartens. The survey is conducted in Zagreb (Croatia), Skopje (Macedonia) and Sofia (Bulgaria).

Your views and needs are very important for the proper design of this type of products and can significantly contribute to a systematic, healthier and more creative design of your own and your children's environment. Therefore, we would like to kindly ask you to take some time and try to answer the questions below. It will take you about twenty minutes. Unless otherwise stated, always circle only one answer to a question.

At the end of the questionnaire there is a blank box in which you can enter your comments, recommendations and reflections or clarify your answer to some of the questions.

Thank you for your help and patience!

Department of Furniture and Wood Products Research Team

University of Zagreb, Faculty of Forestry, Department of Wood Technology.

For additional questions and information, please feel free to contact us directly at the following e-mail address:

MSc Boris Iliev, PhD candidate: borisnikolailiev@gmail.com

Danijela Domljan, PhD: ddomljan@sumfak.hr




Zoran Vlaović, PhD. zvlaovic@sumfak.hr

The address of the kindergarten you work in: _____
Date of completion of the questionnaire: _____

1. Please, specify your profession:	_____
2. How many years of work experience do you have:	<ul style="list-style-type: none"> a) 0-5 years b) 6-10 years c) 11-15 years d) 16-20 years e) 21-30 years f) more than 30 years.
3. What type of work do you do in your current kindergarten job?	_____
4. In which part of the city is your kindergarten located?	<ul style="list-style-type: none"> a) very centre of the city /settlement b) broader centre of the city /settlement a) outside the settlement.
5. Your kindergarten has a total of:	<ul style="list-style-type: none"> a) less than 50 children b) between 50 and 99 children c) between 100 and 199 children d) between 200 and 299 children e) more than 300 children.
6. How many educational groups (overall, regardless of the children's age) are there in your kindergarten:	<ul style="list-style-type: none"> a) 1 to 3 groups b) 4 to 10 groups c) 10 to 15 groups d) 15 to 20 groups e) more than 20 groups
7. In what type of group do you work:	<ul style="list-style-type: none"> a) nursery group (1 to 3 years of age) b) older group (3 to 7 years of age) c) a mixed group d) in multiple groups, depending what is required.

8. How many children do you have in your group (several answers are possible if you work in multiple groups):	<ul style="list-style-type: none"> a) less than 10 b) 11-15 c) 16-20 d) 21-25 e) 25-30 f) 31-35 e) more.
9. In your group, you work with more children than stipulated by the standard (the city standard regulated the number of children per group):	<ul style="list-style-type: none"> a) yes b) no.
10. What type of activities do you practice the most:	<ul style="list-style-type: none"> a) activities in a larger group b) activities in smaller groups c) individual activities d) all types of activities, depending on the type of task.
11. The space (room) where you work with children is:	<ul style="list-style-type: none"> a) is of appropriate size b) is too small c) is too big d) I don't know, I'm not paying attention.
12. The space (the room) for working with children should be:	<ul style="list-style-type: none"> a) open, without partitions and with a lot of furniture b) divided into many small functional units with adequate furniture c) one part is open and the other combines a number of thematic units (the so-called playing corners) d) a polyvalent space where I am able to create appropriate units together with the children e) I don't know, I'm not paying attention.
13. There is too much furniture in the room(s) where you work with children:	<ul style="list-style-type: none"> a) yes b) no c) the current situation is satisfactory.
14. The floors in the rooms where the children are most likely to stay should be covered with:	<ul style="list-style-type: none"> a) parquet b) carpet or tapestry c) combined carpet and parquet flooring d) rubber or linoleum e) ceramic tiles. f) it does not matter what kind of flooring g) I do not know.

Children's furniture and wooden products in kindergartens 5
Questionnaire

26. The chairs on which children sit should have armrests:	a) yes, mandatory for all ages b) for 1-3 year-old children only c) for 3-7 year-old children only d) no e) I do not know.
27. The chairs should have soft (upholstered, padded) parts in contact with the child's body:	a) yes, as a rule b) only the seat c) only the backrest d) no e) I do not know.
28. Children's chairs should be made mostly of which materials:	a) wood and wood materials b) plastic c) metal d) sponge e) a combination of different materials f) I do not know.
29. Chairs in the nursery should have a serving plate (feeding table):	a) yes b) no c) I do not know.
30. Chairs for nursery children should be: (examples on the pictures)	a) low  b) high  c) adjustable from a lower to a higher position  d) I do not know.
31. Chairs and children's tables should be adjusted according to the children's height:	a) yes, as a rule b) no, the adjustment seems complicated to me c) not necessary, but it can be useful d) I do not know.
32. Children should be able to move the chairs themselves without your help:	a) yes b) no c) I do not know.




Children's furniture and wooden products in kindergartens 4
Questionnaire




15. The room I work in lacks furniture or equipment for storing didactic equipment, books and toys:	a) yes b) no c) I do not know.
16. The audio-visual equipment is positioned on appropriately designed furniture:	a) yes b) no d) I do not know.
17. The colour of the furniture should be:	a) in one colour b) in multiple colours c) combining wood and colours d) in wood texture e) I do not know.
18. Do you often move furniture in rooms:	a) yes b) no, never c) occasionally.
19. If yes or occasionally, can you move the furniture around without any difficulty:	a) yes b) no c) partially
20. I notice damage on the furniture:	a) rarely b) sometimes c) often.
21. The furniture in the room should be:	a) easily to move around both to me and the kids b) difficult to move, but I should be able to move it myself c) stationary (mounted or fixed).
Children's chairs	
22. How many different types of chairs (by appearance) do you have in the room where you work with children:	a) one b) two c) three d) more than three.
23. How many different chair heights do you have in the room where you work with children:	a) one b) two c) three d) more than three.
24. The heights of the chairs on which the children sit are in correlation with the height of the children:	a) too high b) too low c) appropriate d) I do not know.
25. The chairs should have different sizes and be aligned to a child's body measures:	a) yes b) no c) I do not know.

University of Zagreb - Faculty of Forestry

University of Zagreb - Faculty of Forestry

Children's furniture and wooden products in kindergartens		6
Questionnaire		Questionnaire
33. In the nursery group, children should have chairs for sitting and dining on their own.	a) YES, as a rule b) no, it's not necessary c) I do not know. d)	
Children's tables		
34. What type of table do you find most appropriate for working with children:	a) a table with a round worktop b) a table with a rectangular worktop c) a table with a semiround worktop d) a table with a trapezoid worktop e) tables with irregular worktop shapes.	
35. Tables in the room should be installed:	a) in all parts of the room b) in only one part of the room c) wherever there is enough space d) depending on the type of work/game e) I do not know.	
36. How many children should sit at one table	a) 1-2 b) 3-4 c) 4-6 d) 6-8 e) more than 8. f) depending on a current need, work and type of playing g) I do not know.	
37. The tables in the room where you work with your children are the right size:	a) YES b) no c) I do not know.	
38. The edges of the worktops are:	a) appropriately rounded b) they have sharp edges and are dangerous for children c) I do not know.	
39. The tables in the room where you work with your children:	a) move slightly b) difficult to move c) stationary (fixed).	
40. Tables for children should have wheels for easier mobility.	a) YES b) no c) I do not know.	
41. The heights of the chairs on which the children sit in correlation to the height of the children are:	a) too low b) too high c) appropriate d) I do not know.	
Children's furniture and wooden products in kindergartens		7
Questionnaire		Questionnaire
Children's beds		
42. Children's beds in your kindergarten are made of:	a) wood b) plastic c) plastics and nets d) various combinations of materials, please state which _____ e) I do not know.	
43. Children's beds in your kindergarten are:	a) collapsible (I can fold and store them) b) unfoldable (I can stack them) c) different, please state _____ d) I do not know. e)	
44. In terms of usage, children's beds are:	a) difficult to manipulate (or handle) b) they cannot simply be folded or stacked, something always gets stuck c) they are easy to manipulate with d) I don't know, I'm not paying attention.	
45. The bedding on which the children sleep is:	a) wooden, without any slits or holes b) wooden with slits or holes for ventilation c) wooden bars d) plastic without holes or slits e) plastic with slits or holes f) mesh strained to the bed frame g) textile, strained to the bed frame h) something else, please specify what: _____	
46. Children on children's beds sleep on:	a) a wooden base and sponge mattress b) a plastic base and sponge mattress c) a plastic base covered with a sheet d) a mesh base covered with a sheet e) fabric covered with a sheet f) something else, please state what: _____	
47. Who is putting the bedding on children's beds?	a) cleaning ladies b) I and the staff c) I and the kids d) the children themselves.	

Children's furniture and wooden products in kindergartens		9
		Questionnaire
52. The cabinets are too high in the room, the children cannot reach their things:	a) yes b) no c) I do not know.	
53. When it comes to the height, shelves and drawers in a cabinet should be:	a) at the height of the child's reach so they can be used as work space b) high so that children cannot use them c) depending on the contents; a) and b) d) children should not be allowed to use cabinets e) I do not know.	
54. In terms of mobility, storage furniture should be:	a) exclusively on wheels b) without wheels and harder to move c) built-in (stationary).	
55. Furniture for the disposal of teaching aids, toys and similar content should have more:	a) shelves b) drawers c) hooks or hangers d) all of the above e) I do not know.	
56. Storage furniture in the room where I work with children is stable:	a) yes b) no c) a certain part d) I do not know.	
57. What type of cabinet (wardrobe) do you prefer to use:	a) open	
	b) closed with doors	
	c) combined, open-closed	
	d) I do not know.	
Other		
58. The furniture in the room where you spend most of the time with children is damaged:	a) yes, often b) yes, but not so often c) yes, but rarely d) not at all e) I do not know.	

Children's furniture and wooden products in kindergartens		8
		Questionnaire
48. Children's beds are located:	a) in the room where we perform most of our educational activities b) in a sleeping room (a dormitory) c) in the hallway d) everywhere, we don't have enough space so we cope e) otherwise, state where and how	
49. A place for children's rest and sleep should be set up:	a) in a separate bedroom b) in the same room where educational activities take place c) does not matter where.	
50. Kindergartens should generally also have bunk beds:	a) yes, they would save space b) yes, but only if there is a dormitory in the kindergarten c) no, that is dangerous for children d) I do not know.	
Furniture intended for storage (includes: cabinets, shelves, drawers, dressers, display cases, chests, etc.)		
51. What type of storage furniture do you prefer:	a) cabinets (with doors and shelves inside)	
	b) shelf system (cabinet with shelves but no doors)	
	c) different types, depending on what is needed	
	d) I do not know.	

Children's furniture and wooden products in kindergartens
Questionnaire

Children's furniture and wooden products in kindergartens
Questionnaire

66. How satisfied are you with the colours of the room where you are currently working with children:
- not at all 1 2 3 4 5 completely
67. Do you have enough space to move around in the room where you are currently working with children:
- not at all 1 2 3 4 5 completely
68. The furniture in the room where you are currently working with children is safe:
- not at all 1 2 3 4 5 completely
69. The kindergarten furniture is suitable for children:
- not at all 1 2 3 4 5 completely
70. The chairs currently used in your kindergarten should have different structural design (appearance, shape, colours, materials...):
- not at all 1 2 3 4 5 completely
71. Children's tables could have other contents besides a flat playing and eating surface (e.g. surfaces for storing accessories and toys, extra drawers, etc...):
- not at all 1 2 3 4 5 completely

59. If yes, what type of furniture is most damaged by use:
- a) chairs and tables
 - b) tables
 - c) cabinets
 - d) cabinet doors
 - e) shelves
 - f) armchairs
 - g) other: _____
60. Children's restrooms [toilets and washbasins] should be located:
- a) close to the room where the children spend time
 - b) away from the room where the children spend time
 - c) I do not know.
61. Food should be served in rooms where children spend most of their time in a kindergarten:
- a) yes, in the same room
 - b) no, there should be a separate dining room
 - c) I do not know.
62. You should obtain training with experts in the application and use of children's furniture in the kindergarten:
- a) yes
 - b) no
 - c) maybe.
63. I would love to help design new furniture and accessories for children in kindergartens:
- a) yes, I have a lot of experience and ideas that could help
 - b) no, I don't want to
 - c) I do not know.

64. How satisfied are you with the arrangement of the room where you are currently working with children:
- not at all 1 2 3 4 5 completely
65. How satisfied are you with the furniture in the room where you are currently working with children:
- not at all 1 2 3 4 5 completely

72. Children's tables currently used in your kindergarten should have different structural design (appearance, shape, colours, materials...):



73. Setting up and making children's beds daily is a problem for me:



74. Children's beds currently used in your kindergarten should have different structural design (appearance, shape, colours, materials...):



If these questions have inspired you to come up with new proposals, remarks and ideas regarding the design of kindergarten furniture and equipment, please write down your suggestions. Thank you!

THANK YOU FOR COOPERATION!

APPENDIX III. SURVEY RESULTS OF THE RESPONDENTS /EDUCATORS - SUGGESTIONS AND COMMENTS

Results of Polygon III, Sofia:

Ако тези въпроси Ви вдъхновяват за нови предложения, забележки и идеи, относно обзавеждането и оборудването в детските градини, моля, напишете вашите предложения. Благодаря!

Да е уютно, практично и съобразено с възрастовите особености на децата. Цветно, лесно и добре архитектурно!

I²¹

Ако тези въпроси Ви вдъхновяват за нови предложения, забележки и идеи, относно обзавеждането и оборудването в детските градини, моля, напишете вашите предложения. Благодаря!

Имам забележка към размера на леглата. Съвременните деца са високи и в III и IV гр. леглата са им къси.

II²²

Ако тези въпроси Ви вдъхновяват за нови предложения, забележки и идеи, относно обзавеждането и оборудването в детските градини, моля, напишете вашите предложения. Благодаря!

Смятам че мебелите трябва да се отговарят на потребностите на децата, но да имат и своя индивидуалност, съобразно възрастта на радомещите с децата.

III²³

²¹ To be comfortable, practical and compatible to the children's age. To be in color, colorful and well arranged.

²² I have a note on the size of the beds. Nowadays the children are tall; the beds are small both in the big and preschool group.

²³ I think that the furniture should suit the needs of the children, but it should also have its own individuality adapted to the attitudes of the staff.

Ако тези въпроси Ви вдъхновяват за нови предложения, забележки и идеи, относно обзавеждането и оборудването в детските градини, моля, напишете вашите предложения. Благодаря!

Да има достатъчно шкафчета
шкафове, в които да се
съхраняват материалите,
за които полагаме много труд.
Вратата от запитаната към
балката и таванната тръба да
бъде директна.

IV²⁴

Results of Polygon II, Zagreb:

Ako su Vas ova pitanja inspirirala na nove prijedloge, primjedbe i ideje vezana uz oblikovanje namještaja i opreme u vrtićima, molimo Vas da napišete svoje prijedloge. Hvala!

NAMJEŠTAJ DOKOLNA VIŠE POVEZANOG
SA PRIRODOM: OBLIKI NAMJEŠTATA INSP.
DIZIJNI PRID. POJAVLJENJA, - ŽIVNI SVIJE,
ŽIVOTINJSKI, NEUMIR....

V²⁵

Ako su Vas ova pitanja inspirirala na nove prijedloge, primjedbe i ideje vezana uz oblikovanje namještaja i opreme u vrtićima, molimo Vas da napišete svoje prijedloge. Hvala!

Potrebno je više pažnje posvetiti na to kako
boje optenilo djeluju na ljude, pa tako i na
djecu. Koge boje koristiti? Treba li sve biti
šareno? Isto tako i prilikom odabira
materijala. Trebaju li biti umjetni?

VI²⁶

²⁴ There should be enough lockers for the didactic means, in which the materials (for which a lot of time and effort have been spent) would be stored.

²⁵ The design of the furniture to be related to nature. Shape that are inspired by natural phenomena, plants, animals, the space...

²⁶ More attention needs to be paid to how colors affect people, as well as children. What colors to use? Should everything be colorful? When choosing materials, should they be artificial?

Ako su Vas ova pitanja inspirirala na nove prijedloge, primjedbe i ideje vezana uz oblikovanje namještaja i opreme u vrtićima, molimo Vas da napišete svoje prijedloge. Hvala!

NAMJEŠTAJ U VRTIĆU TREBA BITI INDIVIDUALAN TAKO
DA DJECA OMOGUĆE ŠTO VEĆU NEOVISNOST I SAMO-
STOJNOST U NJEGOVOM KORIŠTENJU.
VRATA SVIH ORMARICA BI TREBALA IMATI STOPERE
DA SE SPREČE POUVEDE. TAKODER I SAMI NAMJEŠTAJ
S KOŠČIĆIMA BI SE TREBAO MOĆI FIKSIRATI.
ORMARICI ZA DIDAKTIKU BI MOGLI IMATI SKLAPIVE
PLOTIJE KOJE MOGU POSLUŽITI ZA IGRU, ODLAGANJE
ILI NEŠTO DRUGO PO POTREBI.
OTVORENI SAMI ZA FUNKCIJU !!
HVALA I VAMA!

TINA BEBIĆ
ODGOJATELJICA U DV TRŠĆANJEVKA
mail: tina.bebic@zg.t-com.hr

VII²⁷

Ako su Vas ova pitanja inspirirala na nove prijedloge, primjedbe i ideje vezana uz oblikovanje namještaja i opreme u vrtićima, molimo Vas da napišete svoje prijedloge. Hvala!

U KONTEKSTU FUNKCIONALNOSTI NAMJEŠTAJA, KAKO JE POKRETLI PER U NJI, MOGU
DJECA, VELO JE VAŽNO DA POSTUJE ADEKVATNE KOŠČICE =
SVE ŠTO IMA KOŠČICE MORA IMATI I KOŠČICE.

PRIJEDLOG, UKLJUČIVANJE STRUKE U VEŠTAČENJE NAMJEŠTAJA (DIZAJN, FUNKCIONALNOST,
POLIVALENTNOST, I.T.D. - VEŠTAČIĆI VAŽNE), AUTENT. OČUVANJE ISKUSTVA, DISKUSIJE,
RAZMJENE ISKUSTVA, ISKAZIVANJE INTERESA I POTREBA.

FUNKCIJA HATERIJA !! :)

VIII²⁸

²⁷ Furniture in kindergartens need to be redesigned so that children can be more independent in their use. Cupboard doors should have stoppers to prevent injury, and wheel furniture should also be fixed. Didactic cupboards should have folding plates that can be used as a place to play, to procrastinate or something else in need.

²⁸ In the context of furniture mobility, which is desirable because children can participate as well, it is very important to have an adequate brake. Everything that has wheels should have a brake. One proposal is to include professions in the manufacture of furniture (such as design, functionality, polyvalence, etc.) with this type of research, discussion, exchange of experiences, expression of interest and need.

APPENDIX IV. SURVEY ON RESPONDENTS - MANUFACTURERS / SUPPLIERS OF PRESCHOOL FURNITURE

(In each polygon, the survey was conducted in the official language of the country)



SVEUČILIŠTE U ZAGREBU - ŠUMARSKI FAKULTET
UNIVERSITY OF ZAGREB - FACULTY OF FORESTRY



Design of furniture in pre-school facilities as a basis for healthy growth and development of children

Questionnaire

To Whom It May Concern

As part of our PhD research at the Faculty of Forestry, University of Zagreb, we are conducting a survey aimed at obtaining information on the design, production and distribution of furniture in kindergartens offered at public tenders for equipping them.

The survey is conducted in Zagreb (Croatia), Skopje (Macedonia) and Sofia (Bulgaria).

Your attitudes, opinions and attitude towards the processes of designing and manufacturing kindergarten furniture, as well as the current conditions related to supply of this type of furniture, are of great importance for the possible improvement of all conditions, from the initial idea to the distribution.

Using the furniture you produce and/or sell can significantly contribute to the systematic, healthier and more creative growth and development of children.

Therefore, we would like to ask you to please take some of your time and try to answer the questions we are asking you in this questionnaire. It will take you about twenty minutes. Unless otherwise stated, always circle only one answer to the question.

Thank you for your help and patience!

Department of Furniture and Wood Products Research Team

University of Zagreb, Faculty of Forestry, Department of Wood Technology.

NAME OF THE COMPANY

Address	
Contact person	
Phone / cell.	
Email address	

date of completion of the survey



Svetišćinske 25, p. p. 432, 10002 Zagreb, Hrvatska, tel. +385 (0)1 235 26 55, fax. +385 (0)1 231 86 16
e-mail: sumarski-fakultet@zg.t-com.hr, mrežni-brop: 3281-485, zbir-račun: 2360000-1101340148
www.sumfak.hr

A 5.	Are you satisfied with the process of public opening of the bidding documents submitted ...	<p>a) yes, completely b) mostly yes c) mostly not d) not at all</p>
A 6.	Specification documentation should be improved in the following way:	<p>a) To contain the exact dimensions of each piece of furniture b) To contain a detailed list of specified characteristics of particular forms with drawings c) To contain a detailed description of characteristics of the product being procured certificates d) To define specific terms in the tender documentation in a more detailed manner e) Other (please state what): _____ _____</p>
A 7.	The Commission for the selection of the best bidder, is made up of an appropriate number of professionals...	<p>a) yes b) no c) I do not know</p>
A 8.	The Commission for the selection of the best bidder should have an expert in the field of... (multiple responses are possible)	<p>a) economy b) law c) design / architecture d) wood technology e) quality f) medicine g) something else _____ h) I do not know</p>
A 9.	The Republic of Croatia lacks a detailed Guide or Rulebook for equipping kindergartens and defining the characteristics of such furniture...	<p>a) yes b) no, but the existing one needs to be modified c) no d) I do not know</p>
A 10.	If you think that the Regulations or Guide are needed, please write your thoughts on what they should and could contain...	<p>_____ _____ _____</p>
A 11.	Your company is applying for a tender, because you believe that... (multiple responses are possible)	<p>a) we have all the required elements in accordance with our price of the product b) we have all the required elements according to the documentation and can compete with the quality of the product (at a slightly higher price) c) we have already started cooperation with kindergartens, which we equip with our own product d) we collaborate with the architect/designer when equipping a kindergarten and produce furniture and equipment in accordance with his or her requirements e) we have a proper product line that contributes to the healthy development of children f) I do not know g) something else (please specify)</p>

Question group O COMPANY PROFILE

O 1.	What is your main registered business activity?	<p>a) manufacture of furniture, products and semi-finished wood products b) sale of furniture, products and semi-finished wood products c) production and sale of final timber products d) import and sale of final products e) import of furniture parts, assembly and sale of the final product f) something else (please specify what) _____</p>
O 2.	How many employees does your company have?	(please enter the number) _____
O 3.	By what organization, your company is...	<p>a) small enterprise (from 1-49 employees) b) medium-sized enterprise (from 50-249 employees) c) large enterprise (more than 250 employees)</p>
O 4.	Your company has been operating and doing business since...	(please enter the number): _____

Question group A TENDERS FOR EQUIPPING KINDERGARTENS

A 1.	How regularly do you apply to tenders for equipping kindergartens?	<p>a) always, to every tender b) mostly yes c) sometimes d) no, we are not applying at all</p>
A 2.	The tender documentation for equipping a kindergarten contains sufficient information in accordance to which you can prepare an appropriate offer...	<p>a) yes, completely b) mostly yes c) mostly not d) if no, please answer A3</p>
A 3.	If the documentation is insufficient, what should be stated in the documentation? (multiple responses are possible)	<p>a) the look and details of the products being procured b) the exact dimensions of the products being procured c) more detailed characteristics of the products being procured d) a detailed description of the quality certificates e) more detailed terms in the tender documentation f) something else (please specify what) _____ _____ _____ _____ _____</p>
A 4.	Do you think that the instructions and specifications provided in the tender documentation are clear enough so that you are able to produce the furniture ...	<p>a) yes, completely b) mostly yes c) mostly not d) not at all</p>

B 2.	What items of furniture and equipment do you produce most?	a) chairs for children b) desks for children and teachers (teacher desks) c) cabinets d) beds e) didactics f) something else (please specify, what)
B 3.	When designing and constructing preschool furniture, which Croatian / European / International Standards do you use?	a) HRN EN 1729:2016 b) HRN EN 1729:2006 c) HRN EN 1729:2003 d) HRN EN 1729:2001 e) HRN B EA_021:1989 f) JUS B EA 201: 1989 g) some other, please specify _____ h) we do not use standards: _____
B 4.	How many height classes (sizes) does your pre-school furniture line comprise, especially for desks and chairs you produce/offer?	a) 1 b) 2 c) 3 d) more than three (please specify how many) _____
B 5.	The height class of the furniture is marked with a specific mark. _____	a) The colour of the stand b) The colour of the desk's work surface table and chair (backrest, seat) c) The colour label on the declaration d) A number (1-7) on the declaration or on the furniture e) A number and colour on the declaration or on the furniture f) In some other way _____ g) We do not provide any labels _____
B 6.	From which basic materials is the preschool desk made of (not including joining devices, fittings, etc.)? Please skip this question if the product line does not comprise desks.	a) solid wood b) solid wood and wood materials c) only wood materials (IT, MDF, etc.) d) wood materials and metal e) metal, plastic f) plastic g) composite materials h) something else, please specify what _____
B 7.	From which basic materials is a preschool chair made of? Please skip this question if the product line does not contain chairs.	a) solid wood b) solid wood and wood materials c) only wood materials (laminated board or the so-called plywood, etc.) d) wood materials and metal e) metal f) metal, plastic g) plastic h) composite materials i) something else, please specify what _____

A 12.	After the publication of a tender, you continue your communication with:	a) the city office b) the kindergarten principal c) Other... _____
A 13.	How many preschool furniture lines do you produce / offer?	a) one b) two c) three d) more than three
A 14.	If you offer a product range from another manufacturer, please provide the name of that company and the country of origin. _____	_____
A 15.	Continuous production/supply of pre-school furniture in your company exists. _____	a) more than 20 years b) from 15 to 20 years c) from 10 to 15 years d) from 5 to 10 years e) up to 5 years f) about a year g) other (please specify) _____
A 16.	You are aware that public institutions in the Republic of Croatia have a legal obligation to order furniture according to European standards. _____	a) yes b) no
A 17.	The pre-school furniture line you produce / offer is tested by an approved testing laboratory. _____	a) yes (please specify which) _____ b) no
A 18.	Do you have certificates proving the tested furniture quality (attestation) and test quality report (test report) for your pre-school furniture product line?	a) yes b) no
A 19.	Do you think that price should be the only requirement in the procurement process?	a) Yes b) No c) I do not know
A 20.	An internal quality control of the furniture is carried out within your company. _____	a) yes b) no

Question group B PRESCHOOL FURNITURE PRODUCTION/OFFER

B 1.	How many basic elements (in total) does each of the pre-school furniture lines (desk, chair, teacher desk, cabinet, wardrobe, TV cabinet, etc.) do you produce/offer?	a) one (e.g. only chairs for children) b) two (e.g. only chairs and desks for children) c) three (e.g. chairs, desks and cabinets for children) d) four (e.g. chairs and desks for children, cabinets and beds) e) five f) six g) more than 6
------	---	---

Question group C ABOUT THE DEVELOPMENT AND DESIGN OF THE PRODUCTION PROGRAM


Note: The question group C is not necessarily answered by suppliers and retailers.

C 1.	You consider product design to be one of the significant elements of the pre-school furniture product range you produce/offer...	<ul style="list-style-type: none"> a) yes b) no c) maybe d) I do not know
C 2.	Who is involved in the development and design of the pre-school furniture line you produce/offer?	<ul style="list-style-type: none"> a) in-house MA in Design b) in-house MA in Architecture c) in-house MS in Wood Technology/Construction d) in-house MS in Mechanical Engineering e) The company's development team f) The company's commercial department g) no one, we get the designer from abroad h) no one, we study existing solutions and align with the production process within our own company i) external collaborator, designer/architect j) someone else (please specify which profession) e) I do not know
C 3.	The development of the product range of preschool furniture lasted... (in your opinion)	<ul style="list-style-type: none"> a) more than one year b) up to 6 years c) up to 6 months d) up to 4 months e) up to 2 month f) we have not been engaged in the development, we took over finalized products from another company g) I do not know
C 4.	The current design of pre-school furniture available on the Creation market meets the contemporary needs of children and teachers ...	<ul style="list-style-type: none"> a) yes b) no c) partially (specify which elements), d) I do not know
C 5.	If not, what should be primarily changed on the furniture?	<ul style="list-style-type: none"> a) appearance (shape) b) construction c) material d) dimensions e) all f) the whole concept of working and sitting g) something else (please specify what) h) I do not know
C 6.	If you were able to change what you would change in the preschool furniture product line?	<ul style="list-style-type: none"> a) appearance (shape) b) construction c) material d) dimensions e) all f) The whole concept of working and sitting g) something else (please specify what) h) nothing needs to be changed please go to C 9 i) I do not know

B 8.	Please skip this and the following question if the product line does not contain cabinets, we skip to B 10. From which basic materials are cabinets made of (wardrobe, accessories, teacher cabinet, etc...)	<ul style="list-style-type: none"> a) solid wood b) solid wood and wood materials c) wood materials (T, MDF, etc.) d) wood materials and metal e) metal f) metal, plastic g) plastic h) composite materials i) something else, please specify what
B 9.	How many different cabinet heights (OH) do you produce /offer (no doors, full doors, glass doors)?	<ul style="list-style-type: none"> a) one b) two c) three d) four e) more than four
B 10.	Please answer the following two questions if your furniture is mostly made of wood and wood materials. If not, please go to B 12. Desks, cabinets and other elements are made of wood and wood materials from...	<ul style="list-style-type: none"> a) width-length, jointed massive elements b) veneer panels (plywood) c) foil-coated chipboards d) laminated chipboards e) veneered and lacquered chipboards f) foil-coated fibreboards g) laminated fibreboards h) veneered fibreboards i) lacquered fibreboards j) something else (state what)
B 11.	In the production of preschool furniture for the surface treatment of wooden parts you use...	<ul style="list-style-type: none"> a) water based lacquers (water lacquers) b) polyurethane (PU) varnishes c) nitrocellulose (NC) varnishes d) polyester (PE) varnishes e) beeswax coatings (wax varnishes) f) something else (state what)
B 12.	The line uses standard hardware from the manufacturer/supplier ...	<ul style="list-style-type: none"> a) Schachermayer b) Hafels c) Sigma Plus d) D&T e) Herrlich f) Lama g) Grass h) Bloom i) our own j) some other (please specify)
B 13.	Are you satisfied with the construction, production method and quality of the pre-school furniture line you produce / offer...	<ul style="list-style-type: none"> a) yes b) mostly yes c) mostly not d) no
	Which of the following products do you produce sell in the largest quantities:	<ul style="list-style-type: none"> a) Chairs b) Desks c) Chairs and desks d) Cabinets (drawer systems, sliding systems) e) beds f) All of the above g) Other

Appendix V. SURVEY ON RESPONDENTS / CHILDREN - MOSAIC METHOD

(The material was written in Croatian)



SVEUČILIŠTE U ZAGREBU - ŠUMARSKI FAKULTET
UNIVERSITY OF ZAGREB, FACULTY OF FORESTRY


QUESTION WHAT YOU LIKE - a survey in which you found up your favorite things

How old are you? _____


Are you a boy / girl? (Circle) BOY GIRL

Do you go to kindergarten / school? _____


1. Mark where you would most likely sit?





2. Mark where you prefer to stand or lay?



3. Mark where you would most likely draw?



4. Which color do you like the most?

5. Paint the squares with your favorite color

Five empty square boxes arranged horizontally for coloring.

6. Draw your playroom with your favorite furniture

A large empty rectangular box for drawing a playroom.



APPENDIX VI. PERMITS FOR CONDUCTING RESEARCH WITH CHILDREN



Sveučilište u
Zagrebu

Etički savjet Sveučilišta u Zagrebu

KLASA: 602-04/19-17/11
URBROJ: 380-106/334-19-6
Zagreb, 11. srpnja 2019.

Sveučilište u Zagrebu
Šumarski fakultet
Etičko povjerenstvo
Predsjednik
Prof. dr. sc. Nikola Pernar
Svetošimunska cesta 25
10000 Zagreb



Predmet: Mišljenje o sukladnosti postupanja u planiranom istraživanju vezanog uz izradu doktorskog rada mr. sc. Borisa Ilieva s načelima i pravilima Etičkog kodeksa Sveučilišta u Zagrebu

Poštovani gospodine predsjedniče Etičkog povjerenstva,

na svojoj sjednici održanoj 18. lipnja 2019. godine Etički savjet Sveučilišta u Zagrebu (dalje u tekstu: Etički savjet) razmatrao je Mišljenje o sukladnosti postupanja u planiranom istraživanju vezanog uz izradu doktorskog rada mr. sc. Borisa Ilieva s načelima i pravilima Etičkog kodeksa Sveučilišta u Zagrebu od 13. svibnja 2019. godine¹ (dalje u tekstu: Mišljenje).

Etički savjet zahvaljuje Vam na postupanju prema članku 35. stavku 1. Etičkog kodeksa Sveučilišta u Zagrebu (dalje u tekstu: Etički kodeks) i dostavi Mišljenja te Vas obavještava kako je navedeno Mišljenje primio na znanje.

Izradnim Mišljenjem, Etički savjet je dobio cjelokupan i nedvojbjen uvid u predmet, a Mišljenje ujedno sadrži sve propisane dijelove, uključujući i uputu o pravnom lijeku, što kao novi element mora sadržavati svako prvostupajnsko mišljenje. Naime, članak 35. stavak 9. Etičkog kodeksa daje pravo na žalbu dionicima etičkih postupka protiv prvostupajnskih mišljenja etičkih povjerenstava sastavnica.

Etički savjet pohvaljuje rad Etičkog povjerenstava Šumarskog fakulteta, a rad Etičkog povjerenstva Šumarskog fakulteta primjer je dobre prakse među sastavnicama Sveučilišta u Zagrebu.

S poštovanjem,
predsjednik Etičkog savjeta Sveučilišta u Zagrebu
Prof. dr. sc. Valerije Vrček, v.r.

Na znanje:
1. Prof. dr. sc. Damir Boras, rektor
2. Prof. dr. sc. Tibor Pentek, dekan Šumarskog fakulteta
3. Mr. sc. Boris Iliev
4. Pismohrana, ovdje



¹ Primljeno na Sveučilište u Zagrebu 23. svibnja 2019., KLASA: 602-04/19-17/11, URBROJ: 380-106/334-19-2

Sveučilište u Zagrebu, p.p. 407, Trg Republike Hrvatske 14, HR-10000 Zagreb
tel.: +385 (0)1 4364 127; 45 64 107; faks: +385 (0)1 4830 602
e-mail: kbaraba@unizg.hr; ivica.susak@unizg.hr; url: www.unizg.hr



REPUBLIKA HRVATSKA
GRAD ZAGREB
GRADSKI URED ZA OBRAZOVANJE
KULTURU I SPORT

KLASA: 601-02/17-01/495

URBROJ: 251-10-12-17-2

Zagreb, 28. rujna 2017.

SVEUČILIŠTE U ZAGREBU-ŠUMARSKI FAKULTET

Zavod za namještaj i drvene proizvode

Ivica Grbac, predstojnik Zavoda za namještaj i drvene

proizvode

10 000 Zagreb

Svetošimunska 25

Predmet: Provođenje istraživanja proizvoda od drva i dječjeg namještaja u dječjim vrtićima u cilju očuvanja zdravlja djece
- suglasnost, *dostavlja se*

Gradski ured za obrazovanje, kulturu i sport suglasan je s provođenjem istraživanja proizvoda od drva i dječjeg namještaja u vrtićima Grada Zagreba, Mr. sc. Borisa Ilieva, koji je na doktorskom studiju na Šumarskom fakultetu Sveučilišta u Zagrebu.

Cilj istraživanja bio bi uspostava novih kriterija i propisa za oblikovanje predmetne okoline, proizvoda od drva i namještaja u prostorima predškolskih odgojno-obrazovnih ustanova.

S poštovanjem





**GRAD ZAGREB
GRADSKI URED ZA OBRAZOVANJE**

KLASA: 601-02/18-01/21
URBROJ: 251-10-12-18-4
Zagreb, 8. ožujka 2018.

DJEČJIM VRTIČIMA GRADA ZAGREBA
ravnateljima/ravnateljicama

Predmet: Provođenje ankete o namještaju u dječjim vrtićima
- dostavlja se

U okviru istraživanja za doktorsku disertaciju Šumarski fakultet Sveučilišta u Zagrebu uputio je zamolbu ovom Uredu da omogući provedbu ankete u dječjim vrtićima Grada Zagreba s ciljem dobivanja mišljenja vezanog za namještaj i opremu koju svakodnevno koristite pri radu s djecom. Anketa se paralelno provodi u Zagrebu (Republika Hrvatska), Skopju (Republika Makedonija) i Sofiji (Republika Bugarska).

Vaši stavovi i potrebe od velikog su značenja pri odgovarajućem oblikovanju ove vrste proizvoda te mogu značajno doprinijeti sustavnom, zdravijem i kreativnijem oblikovanju vrtićkog okruženja. Stoga molimo da anketu prosljedite radnicima u Vašem vrtiću i organizirate što veći odaziv popunjavanja on-line ankete.

Anketa je on-line i nalazi se na linku:
<https://goo.gl/forms/yvDkViaYxFeo88SV2>

S poštovanjem,



APPENDIX VII. RESULTS OF COMPARING FURNITURE WITH JUS AND BDS STANDARDS

JUS standards D.E4.021:1965 and D.E4.022:1965

Republic of Croatia and Republic of Macedonia 30 years ago used to be in one country, Yugoslavia. In the time of Yugoslav standards there was no EN standards. Instead of it both countries used Yugoslav standards JUS D.E4.021:1965 (***, 1965a) and JUS D.E4.022:1965 (***, 1965b). The standards refer to tables for preschool children (Table 2) and chairs for preschool children (Table 3). Tables 2 and 3 show some important dimensions of chairs and tables used over 60 years ago.

Table 60 Preschool tables and chairs size in standards JUS D.E4.021:1965 and JUS D.E4.022:1965

Standard	Size (The measures are in cm)				
D.E4.021:1965	Height	Height	Width/length	Distance between table and chair	
Tables	48	52	80x80, 90x90, 120x80, 130x75	21, 23	
D.E4.022:1965	Height	length	Height of backrest	Inclination of backrest	Inclination of seat
Chairs	27, 29	22	23	10°	1° -10°

Bulgarian standard BDS (БДС) 8475-88

The Bulgarian standard BDS (БДС) 8475-88 (1988a) covers the functional dimensions of furniture for preschool children. It includes furniture for storing personal belongings, furniture for feeding and working, sitting, and laying. Despite the European standard for furniture for tables and chairs (***, 2015a). The seating furniture is divided into 6 groups, namely: for children up to 1 year, from 1 to 2 years, from 2 to 3 years, from 3 to 4 years, from 4 to 5 and a half, and from 5 and half to 7 years (Table 3). The tables are divided also into 6 groups (Table 4).

Table 61 Preschool chairs size in standards Bulgarian standard BDS 8475 – 88

Parameters	Age of children, years					
	Up to 1	1-2	2-3	3-4	4 -5 ^{1/2}	5 ^{1/2} – 7
	Height (The measures are in mm)					
	510-770	780-880	890-980	990-1040	1050-1140	1150-1250
Seat height from floor, H	160	200	230	250	280	300
Seat width, B	180	180	200	220	240	260
Seat length L, no less than	180	260	260	290	290	320
Tilt of the backrest relative to the vertical	8°					

Table 62 Preschool tables size in standards Bulgarian standard BDS 8475 – 88

Parameters	Age of children, years					
	Up to 1	1-2	2-3	3-4	4 -5 ^{1/2}	5 ^{1/2} – 7
	Height (The measures are in mm)					
	510-770	780-880	890-980	990-1040	1050-1140	1150-1250
Seat height from floor, H	280	380	420	460	500	540
Seat width, B	350	350	400	400	450	450
Seat length L, no less than	350	450	450	450	600	600

Regarding the furniture for storing personal belongings (wardrobes), the BDS determines the height of hanging from the floor, divided into four groups, namely for children aged 2 to 3, from 3 to 4, from 4 to 5 and a half, and from 5 and a half to 7 years. And range within the dimensions of 100, 110, and 120 to 130 cm.

Normative acts for performing a preschool educational process

In the *Rulebook on performing the activity for institutions for children* in the Republic of Macedonia (***, 2016c), the description of the furniture is specified in article 35th paragraph 3rd (***, 2016c, page 13), which states: "Equipment and furniture in kindergartens should be functional, portable, stable, made of quality material, preferably natural one, easy to maintain and with aesthetic appearance and adjusted for the age of the children".

In article 37th of the same Rulebook, a description of the equipment in the playrooms is given, only in terms of dimensions, as follows:

Group of children up to 2 years old:

- Wardrobe cassette 40/30/40 cm.
- Fixed bed with dimensions 60/120/80 cm and 60 cm high fence, with distance between vertically placed obstacles of maximum 8.5 cm (for children up to 18 months old)
- Mobile bed 55/120 cm (for children over 18 months, up to 2 years).
- Tables 80/80/40 cm with 4 chairs each (for children aged 18 months to 2 years) etc.

Group of children aged 2 to 6:

- Bench for taking off shoes with a width of 26 cm, height 38 cm and length 15 cm per child.
- Tables with dimensions 80/80/48 (for children aged 2 to 4 years).
- Tables with dimensions 80/80/56 (for children aged 2 to 6 years).

- Chair with dimensions 31/22/29 (for children aged 2 to 4 years).
- Chair with dimensions 36/24/34 (for children aged 2 to 6 years).
- Mobile bed 55/120 cm. (for children aged 2 to 4 years).
- Mobile bed 55/140 (for children aged 2 to 4 years), etc.

In Article 42nd of the same Rulebook the following conditions have been determined: “The furniture should have rounded edges, easily movable, while the cabinets and high furniture should be fastened to the floor and wall. The furniture should be made of natural materials. Children's tables and chairs should be in accordance with the prescribed standards”.

In the *State pedagogical standard* in the Republic of Croatia (***, 2010a), in article 50th paragraph 3rd, only a general description is given of the furniture in the playrooms where the children are staying. The content is identical to the Macedonian one, which states: “Equipment and furniture of kindergartens must be functional, portable, stable, of quality material, preferably natural one, easy to maintain, steady colors, aesthetic appearance and adjusted for the age of the children”.

In the *Order for the health requirements for kindergartens* in the Republic of Bulgaria (***, 2007) in article 14th, paragraphs 1st and 2nd, a general description of the furniture in the playrooms is given. Contents reads: “Playrooms are equipped with tables and chairs that are in harmony with the anatomical and physiological characteristics of the child. In the playrooms, a feeding section with tables and chairs is equipped, with the anatomical and physiological characteristics of the child”. Article 15th provides a description of sleeping furniture, which reads: “The bedrooms are equipped with beds that are easy to maintain and comfortable to use”.

Comparing the measured chairs and tables with the standard JUS D.E4.021:1965 and JUS D.E4.022:1965

The comparison of the measured chairs from location I and location II according to the JUS standard is shown in Table 33. For the tables, there are no any significant deviations, or if they are some, it is most often in the part of the length of the tables. With red color and marking - (minus) the inconsistency and deviation from the norm are indicated, expressed in cm.

Table 63 Comparison of types of chairs with D.E4.022:1965.

chair type		size to which it belongs according to D.E4.022:1965	deviations (in mm)					
			height of seat	effective depth of seat	height of backrest	Inclination of backrest	Inclination of seat	
			h8	t4	h7	α	$\alpha 1$	
location I	A	Big	60	+	+	+	+	
	B	Small	+	+	+	+	+	
	C	Small	2	+	+	+	+	
	D	Small	2	+	+	+	+	
	D1	Big	5	+	+	+	+	
	E	Big	5	+	+	+	+	
	F	Small	+2	+	+	+	+	
	G	Big	6,5	+	+	+	+	
	H	Small	-3	+	+	+	+	
	J	Big	2	+	+	+	+	
	J1	Big	3	+	+	+	+	
location II	I	Big	5	+	+	+	+	
	II	Small	-4	+	+	+	+	
	K	Small	2	+	+	+	+	
	L	Small	+	+	+	+	+	
	M	Big	3,5	+	+	+	+	
	N	Big	6					
	N1	Big	4	+	+	+	+	
	N2	Big	2					
	N3	Small	-4					
	O	Big	6	+	+	+	+	
	P	P1	Big	5	1	+	+	+
	P2	Small	-2			+	+	+
	R	R1	Big	6		+	+	+
R2	Big	5	+	+	+	+		
	Big	1						
S	Small	-4.5	+	+	+	+		

Comparison of the measured furniture with the standard BDS (БДС) 8475 – 88

The comparison of the measured dimensions of the chairs and tables from location III with the BDS is shown in the following Tables 34 and 35. With red color and underline the inconsistency and deviation from the norm BDS (БДС) 8475 - 88 are indicated, expressed in cm. The dimensions in the Bulgarian standard for table sizes, compared with the European one, range within the size marks from 0 to 2. Within it there are two sizes smaller than size mark 0, while the other four enter the range of size mark 1 and 2. The same goes for the chairs. Two sizes are smaller than size mark 0, while the other four sizes of the BDS enter the dimension range of size mark from 0 to 2.

Table 64 Comparison of type of chairs with BDS 8475 – 88

type of chair	size mark according to BDS 8475 – 88	Dimensions (in mm)			
		height of seat	width of seat	effective depth of seat	Inclination of backrest
		h8	b3	t4	α1
T	6	+	+5	-7	+
U	6	+5	+3	-3,5	-
U1	5	+1	+3	-3	-
V	6	+0,5	-2	-3	-
W	6	+7	/	+	-
X	5	+0,5	+4	+	+
Y	6	+2	+4	-6	-
Z	6	+2	+4	-1	+

Table 65 Comparison of type of tables with BDS 8475 – 88

type of table	size mark according to BDS 8475 – 88	Dimensions (in mm)			
		height of table top	depth of table top	width of top, per person at front edge, where pupils sit	
		h1 (± 2 cm)	t1	w1	
location III	16	6	+2	-10	-20
	17	6	-2	-10	-15
	18	6	+2	-10	-20
	19	5	+2	-10	-10

Regarding the furniture for storing personal belongings (wardrobes), the BDS determines the height of hanging from the floor, divided into four groups, namely for children aged 2 to 3, from 3 to 4, from 4 to 5 and a half, and from 5 and a half to 7 years. The dimensions started from 100, 110, and 120 to 130 cm. All measured samples fit into the dimensions prescribed by the standard. The wardrobes also fit into the dimensions that are determined by the standard in terms of the height of the hanging measured from the lower shelf and the width of the locker. The only deviation from the standard is in the height intended for the storage of footwear and hats, which is determined to be not less than 25 cm.

Comparison of the furniture with normative acts for a preschool educational process

The comparison of the measured dimensions of the chairs, tables, and beds from location I with the Rulebook on Performing the Activity of Institutions for Children in the Republic of Macedonia (***, 2016c), is shown in Table 36. With red color and marking - (minus) the inconsistency and deviation from the normative are indicated, expressed in cm.

Table 66 Comparison of types of furnitures with the ulebook

Type of chair			Dimensions									
			height of seat	width of seat	effective depth of seat	Table	height of table top	depth of table top	Width of top surface	bed	width of bed	depth of bed
			h8	b3	t4		h1 (± 20 mm)	t1	b1		B	L
Location I	A	Big	1	-6	+	1	ok	156/76	74	A1	+	+
	B	small	-2	1	+	2	-5	-6	-6	A2	+	+
	C	small	+	4	+	3	2	+	+	A3	+	+
	D	small	+	1	+	4	2	+	+			
	D1	Big	+	+	+	5	2	+	+			
	E	Big	+	-1	+	6	2	+	+			
	F	small	-4	1	+	7	-4	+	+			
	G	Big	1,5	7	+	8	-4	-18	-18			
	H	small	-5	1	+							
	J	Big	-3	1	+							
	J1	Big	-2	+	+							

CURRICULUM VITAE

M. Sc. Boris ILIEV, Master of Science in Wood Technology, was born on December 23, 1983 in Strumica, Republic of Macedonia. In 2002 he graduated from a high school in Skopje, and in 2008 he graduated from the Faculty of Forestry in Skopje, majoring in Design and Technology of Furniture and Interior. In 2011 he completed his master studies at the Faculty of Design and Technologies of Furniture and Interior in Skopje, major in Furniture and Interior Design.

He enrolled in postgraduate doctoral studies in 2016 at the Faculty of Forestry in Zagreb, department of Wood Technology, majoring in Furniture Design and Wood products. In 2021 he submits his doctoral dissertation entitled "Furniture design in facilities for preschool education as a basis for healthy children's growth and development".

From 2003 to 2005 he was at the Faculty of Architecture in Florence in Italy, and from 04.03.2019 to 07.06.2019 he took part in a professional training upon the Erasmus + mobility in the Faculty of Forestry and Wood Science in Prague, Czech Republic.

He helps and assists in the teaching process with assoc. prof. Danijela Domljan and participates in projects taking place at the Faculty of Forestry in Zagreb.

From 2007 to 2014 in Skopje, Republic of Macedonia he works in a furniture design and construction factory and as a horticultural designer in a public enterprise. From 2014 to 2017 in Sofia, Republic of Bulgaria he works as a furniture and interior designer in several companies.

With his design solutions and projects, he participates in arranging more than a hundred kitchens and complete interior solutions of residential and commercial buildings. For more than 10 years he has been researching the furniture and the interior of the kindergartens as well as all the factors that have an influence to them. So far, he has published over 10 scientific papers, and has held several lectures and poster sessions at international conferences.

ŽIVOTOPIS

Mr. sc. Boris ILIEV, magistar inženjer drvne tehnologije, rođen je 23. prosinca 1983. godine u Strumici, Makedonija. Godine 2002. završio je srednju školu u Skoplju, a 2008. godine diplomirao na Šumarskom fakultetu u Skoplju na temu dizajna i tehnologije namještaja i interijera. Godine 2011. završio je magistarski studij na temu namještaja i dizajna interijera na Fakultetu za dizajn i tehnologije namještaja i interijera u Skoplju.

Poslijediplomski doktorski studij iz dizajna namještaja i drvnih proizvoda upisao je 2016. godine na Šumarskom fakultetu u Zagrebu, doktorski studij Drvne tehnologije. U 2021. brani doktorsku disertaciju naslovljenu "Oblikovanje namještaja u zgradama za predškolski odgoj i obrazovanje kao temelj zdravoga dječjega rasta i razvoja".

Od 2003. do 2005. boravio je na Arhitektonskom fakultetu u Firenci u Italiji, a od 04.03.2019. do 07.06.2019. sudjelovao je u okviru Erasmus + mobilnosti na stručnom usavršavanju Fakulteta šumarstva i znanosti o drvu u Pragu u Češkoj.

U nastavnom procesu pomaže i neslužbeno asistira izv. prof. dr. sc. Danijeli Domljan te također sudjeluje na projektima koji se odvijaju na Fakultetu šumarstva i drvne tehnologije u Zagrebu.

Od 2007. do 2014. u Skoplju radi u tvornici koja se bavi dizajnom i konstrukcijom namještaja i kao projektant hortikulture u javnom poduzeću. Od 2014. do 2017. u Sofiji radi kao dizajner namještaja i interijera u nekoliko tvrtki.

Svojim dizajnerskim rješenjima i projektima sudjeluje u uređenju više od stotinu kuhinja i kompletnih rješenja interijera za opremanje stambenih i poslovnih zgrada. Više od deset godina istražuje namještaj i interijere vrtića te razne faktore koji na utječu na njihovo opremanje. Do sada je objavio više od deset znanstvenih radova, a održao je i nekoliko predavanja i predstavljanja plakata na međunarodnim konferencijama.

LIST OF PUBLISHED PAPERS

1. Iliev, B., 2012: Rural architecture in Ljubojno, Prespa. (Културно наследство), National Conservation Center, XXXVIII. Skopje: 153 – 174.
2. Iliev, B., Karanakov, V., 2012: The anomalously designed children furniture as a reason for curvature. International journal of wood science, design and technology, International indexed journal ISSN 1857 – 9140. Volume I, No. 1. Skopje: 6-11.
3. Boris, I., Karanakov, V., Nikoljska Panevski, E., 2013: Analysis of the impact of the tradition and the traditional skills of production on the historical development of the Scandinavian design. International journal of wood science, design and technology - International indexed journal ISSN 1857 – 9140. Volume 2, No. 1. Skopje: 73-81.
4. Iliev, B., Domljan, D., 2016: Anthropometric analysis as an important method for designing suitable furniture for preschool children. Proceedings of 27th International Conference on Wood Science and technology (ICWST): Implementaton of wood science in woodworking sector / Grbac, Ivica (ur.). Zagreb: University of Zagreb Faculty of Forestry: 83-88.
5. Iliev, B., Domljan, D., 2017: Comparison between preschool tables used in kindergartens in Croatia, Macedonia and Bulgaria. Proceedings of 28th International Conference on Wood Science and technology (ICWST): Implementaton of wood science in woodworking sector. Zagreb, University of Zagreb Faculty of Forestry: 207-214.
6. Vuglek, T., Iliev, B., Grbac, I., Domljan, D., 2018: An analysis of wooden toys that encourage children's growth and development. Proceedings of 29th International Conference on Wood Science and technology (ICWST): Implementaton of wood science in woodworking sector. Zagreb, University of Zagreb Faculty of Forestry: 203-207.
7. Iliev, B., Domljan, D., Vlaović, Z., 2018: Importance of anthropometric data in design of preschool furniture. Book of Proceedings of the 7th International Ergonomics Conference Ergonomics 2018 - Emphasis on Wellbeing / Sumpor, Davor ; Jurčević Lulić, Tanja ; Salopek Čubrić Ivana ; Čubrić, Goran (ur.). - Zadar : Croatian Ergonomics Society. Zadar, Hrvatska: 141-148.
8. Iliev, B., Domljan, D., Vlaović, Z., 2019: Compliance of Preschool Chair Dimensions. Drvna industrija 70 (2019), 2: 175-182.
9. Dijanošić, I., Iliev, B., Dijanošić, O., Domljan, D., 2019: Impact of the environment and objects in preschool institutions on the healthy growth and development of children. Book of Abstracts of 3rd Scientific and Professional International Conference Health of Children and Adolescents. Portorož, University of Primorska Press.

10. Domljan D., Šimek, M., Dijanošić, I., Iliev, B., 2020: Analysis of preconditions for design of sensory environment in czech, bulgarian, Macedonian and Croatian kindergartens. Proceeding of Scientific Paper, Sustainability of forest-based industries in the global economy. Vinkovci, Croatia: 321-325.
11. Iliev, B., Domljan, D., 2020: The kindergarten interior as an important factor for the healthy development of preschool children. INNO Wood 2020 Sofia, Bulgaria, Faculty of Forestry.